

# Environmental Impact Assessment

---

Document Stage: Draft  
Project Number: 51077-003  
March 2020

## MLD: Greater Malé Waste-to-Energy Project – Waste to Energy Plant PART A

## CONTENTS

	<b>Page</b>
EXECUTIVE SUMMARY	
I. INTRODUCTION	1
A. Background	1
B. Purpose and Scope of the EIA	3
C. Stage of the project preparation	4
D. EIA Preparation and Implementation	4
E. Methodology	5
II. DESCRIPTION OF THE PROJECT	6
A. Project Components	12
B. Environmental Considerations in Project Design	25
C. Project Layout Arrangement	34
D. Bottom Ash Reuse and Disposal	35
E. Construction Schedule	36
III. POLICY, LEGAL AND ADMINISTRATIVE FRAMEWORK	36
F. ADB Safeguard Policy Statement	36
G. National Environmental Impact Assessment Law and Regulation	37
H. Issuance of Environmental Decision Statement under the National EIA Law	39
I. Applicable Environmental Standards	40
J. Other Relevant National Laws and Regulations	45
K. Applicable International Environmental Agreements	52
IV. ANALYSIS OF ALTERNATIVES	52
A. No Project Option	52
B. Alternative Options for the Management of Waste	53
C. Alternative Incineration Technologies	55
D. Alternatives on Discharge Locations for WTE Cooling Water	60
E. Alternatives on Intake Location for WTE Cooling Water	76
V. DESCRIPTION OF THE ENVIRONMENT	77
A. Geology and Topography	77
B. Reclaimed Land for the Development of the WTE plant	78
C. Terrestrial Environment	79
D. Coastal Environment	102
E. Biological Environment	115
F. Protected Areas and Critical Habitats	137
G. Socio-Economic Conditions	140
H. Additional Baseline Data Gathering.	147
VI. ANTICIPATED ENVIRONMENTAL IMPACTS AND MITIGATION MEASURES	147
A. Overview of Anticipated Impacts and Mitigation Measures	147
B. Impacts Due to Location of Project	148
C. Impacts Due to Physical Integrity of the Site	148
D. Impacts Due to Design of Project	149
E. Impacts on Marine Protected Areas	156
F. Impacts on Groundwater and the Terrestrial Environment	157

G.	Impacts on Avifauna	158
H.	Impacts on Critical Habitats	158
I.	Impacts on Socio-Cultural Resources	159
J.	Impacts During Construction Phase	159
K.	Impacts during Operational Phase	167
VII.	INFORMATION DISCLOSURE, CONSULTATION AND PARTICIPATION	233
A.	Follow-On Consultation Activities and Focus Group Discussions	238
B.	Future Consultation Activities	250
C.	Information Disclosure	251
VIII.	GRIEVANCE REDRESS MECHANISM	252
A.	First Tier (DBO Contractor)	252
B.	Second Tier (PMU/MOE)	252
C.	Third Tier (Judiciary)	252
IX.	ENVIRONMENTAL MANAGEMENT PLAN	254
A.	Objectives	254
B.	Institutional Arrangement	255
C.	Environmental Management Plan	259
D.	Environmental Monitoring Plan	294
E.	Reporting	301
F.	Cost of EMP Implementation	301
G.	Future Review and Revision of Documents	302
X.	CONCLUSION AND RECOMMENDATIONS	303
XI.	ACKNOWLEDGEMENTS	306
XII.	REFERENCES	307

#### APPENDIXES

1.	Rapid Environmental Assessment Checklist
2.	Compliance Matrix for the Maldives EPA EIA TOR
3.	Gaps Analysis between ADB SPS and Maldives EPPA
4.	Environmental Audit of Existing Facility
5.	Final Report Market Sounding on Reuse of IBA and CWD
6.	Fly Ash Management Plan
7.	Consolidated Report of Marine Surveys
8.	Cooling Water Temperature Dispersion Modeling Report
9.	Report on Baseline Ambient Noise Level Measurements
10.	Results of Laboratory Analyses – Groundwater
11.	Results of Laboratory Analyses – Marine Water
12.	Critical Habitat Analysis
13.	Socio-economic Baseline Survey Summary
14.	AUSTAL2000 Air Dispersion Modeling Report
15.	AERMOD Modeling Report
16.	Report on GHG Emission
17.	Consolidated Minutes of Stakeholders Consultations
18.	Terms of Reference of Project Management, Design and Supervision Consultant
19.	Terms of Reference of External Environmental Expert
20.	QEMR Template
21.	Guidance Notes on Invasive Alien Species (by Maldives MOE)

## **CURRENCY EQUIVALENTS**

(as of 21 November 2019)

Currency Unit	=	Rufiyaa (Rf)
Rf1.00	=	\$0.065
\$1.00	=	Rf15.350

## **ABBREVIATIONS**

ADB	Asian Development Bank
APC	air pollution control
APCS	air pollution control system
BPEO	best practicable environmental option
CEMS	continuous emission monitoring system
CFD	computational fluid dynamics
CCTV	closed circuit TV
DBO	design-build-operate
DCS	distributed control system
EIA	environmental impact assessment
EID	European Industrial Directives
EPA	Environmental Protection Agency
ESA	ecologically sensitive areas
EHS	environmental health and safety
EMOP	environmental monitoring plan
EMP	environmental management plan
EPPA	Environmental Protection and Preservation Act of 1993
GOM	Government of Maldives
GRM	grievance redress mechanism
MCR	maximum continuous rating
MOE	Ministry of Environment
MOF	Ministry of Finance
MMS	Maldives Meteorological Service
MNPI	Ministry of National Planning and Infrastructure
MPA	marine protected areas
MWSC	Malé Water and Sewerage Company
NAPA	National Action Program of Action
NBS	National Bureau of Statistic
NCV	net calorific value
NEAP3	Third National Environment Action Plan
NWMP	National Waste Management Policy
O&M	operation and maintenance
PMU	project management unit
RWMF	Regional Waste Management Facility
SNCR	selective non-catalytic reduction
STELCO	State Electric Company
SWM	solid waste management
TIZ	Thilafushi Industrial Zone
TOR	terms of reference
USEPA	United States Environmental Protection Agency
WAMCO	Waste Management Corporation

## **NOTE**

In this report, "\$" refers to United States dollar.

This environmental impact assessment report is a document of the borrower. The views expressed herein do not necessarily represent those of ADB's Board of Directors, Management, or staff, and may be preliminary in nature. Your attention is directed to the "terms of use" section on ADB's website.

In preparing any country program or strategy, financing any project, or by making any designation of or reference to a particular territory or geographic area in this document, the Asian Development Bank does not intend to make any judgments as to the legal or other status of any territory or area.



## EXECUTIVE SUMMARY

### A. Background

The Greater Malé capital region and its outer islands (project area) suffer from severe environmental pollution and deteriorating livability because of inadequate collection and haphazard disposal of solid waste. The project area covers 35 inhabited islands within the following atolls (island chains): the North Ari Atoll (Alifu Alifu Atoll), South Ari Atoll (Alifu Dhaalu Atoll), Vaavu Atoll and Malé' Atoll (Kaafu Atoll), which includes the capital city of Malé. The total population within the project area is approximately 295,000 (53% of Maldives total population).<sup>1</sup> Lack of a sustainable system to manage the 836 tons per day (tpd) of solid waste generated in the project area (2019) results in waste spillage into the ocean, and open dumping and burning of garbage at the 30-year old 10-hectare dumpsite on Thilafushi Island which has no pollution control measures creating a public health and an environmental hazard.<sup>2</sup> Plumes of smoke visible from the capital Malé, the international airport and nearby resorts compromise air quality and pose nuisance to residents and tourists, while leachate and plastics contaminate the surrounding marine environment. This poses a critical threat to tourism and fisheries, both of which rely heavily on the country's pristine environment and are cornerstones to Maldives' economy.<sup>3</sup>

Support to the government's efforts to strengthen solid waste management (SWM) services in the project area included financing under the GMEIWMP, approved in 2018, to improve the upstream segment of the SWM chain including collection, containerized transfer, and institutional capacity and public awareness for sustainable SWM service delivery.<sup>4</sup> The ongoing project is also assisting the government in treating and recovering construction and demolition waste and implementing temporary measures, such as bailing of municipal solid waste, as adequate interim solution to stop open dumping and burning on Thilafushi until a modern solid waste treatment and disposal facility will be operational. The project is under implementation and expected to be completed by 2023.

The project is aligned with the following impact: promote waste as a valuable resource for income generation (Strategic Action Plan 2019-2023).<sup>5</sup> The outcome will be disaster- and climate- resilient solid waste treatment and disposal services improved in the Greater Malé region and its outer islands. The project will have two outputs.

#### **Output 1: Disaster- and climate-resilient regional waste management facility developed.**

This will include (i) a 500 tpd WTE plant with 20-year O&M contract, including two treatment lines of 250 tpd each, energy recovery of 8 megawatt capacity (surplus electricity) and air pollution

---

<sup>1</sup> Government of Maldives, National Bureau of Statistics – Ministry of Finance and United Nations Population Fund. 2018. *Maldives Population Projections 2014-2054*. Malé.

<sup>2</sup> Breakdown of solid waste by type: construction and demolition = 530 tpd (68%), household = 149 tpd (19%), resort = 48 tpd (6%), commercial = 27 tpd (3%), airport = 9.3 tpd (1.2%), industrial = 6 tpd (0.8%), market = 2.5 tpd (0.3%), hazardous = 1.5 (0.2%), and end-of-life vehicles = 0.65 tpd (0.1%). Source: Government of Maldives, Ministry of Environment and Energy. 2018. Feasibility Study for an Integrated Solid Waste Management System for Zone III (including Greater Malé) and Preparation of Engineering Design of the Regional Waste Management Facility at Thilafushi. Malé

<sup>3</sup> A quarter of country's employment is in tourism and fisheries. Tourism account to 30% of gross domestic product and expected to expand in the area. Government of Maldives, National Bureau of Statistics – Ministry of Finance. 2015 Maldives Population & Housing Census 2014 – Statistical Release 4: Employment. Malé.

<sup>4</sup> ADB. 2018. Report and Recommendation of the President to the Board of Directors: Proposed Grant and Technical Assistance Grant and Administration of Grant to the Republic of Maldives for the Greater Malé Environmental Improvement and Waste Management Project. Manila. (Grant: 0580-MLD and 9195-MLD and TA: 9543-MLD)

<sup>5</sup> Government of Maldives. 2019. *Strategic Action Plan 2019-2023*. Malé.

control (APC) system; and (ii) a landfill for safe disposal of APC residues and non-marketable bottom ashes. The facility will be able to accommodate a third 250 tpd treatment line, required to respond to further demand increase. The WTE technology minimizes land requirements and produces renewable energy addressing the critical land and electricity constraints in the Maldives. Recycling of marketable incineration bottom ash and metals will be promoted to further reduce landfill requirements and provide valuable materials for the construction industry. The WTE will be implemented through a DBO contract with long term O&M period to ensure sustainable operations. All facilities will adopt disaster- and climate-resilient features such as raised floor elevations, flood proof mechanical and electrical equipment and landfill cells, and enhanced drainage systems.

**Output 2: Institutional capacity in sustainable SWM services delivery (WTE) and environmental monitoring strengthened, and public awareness on WTE and 3R improved.**

This will include (i) capacity assessment of MOE and EPA for monitoring and ensuring sustainable WTE operations and support implementation of institutional improvement plan; (ii) strengthening MOE and EPA staff capacity in monitoring WTE operational performance and environmental standards, and managing performance-based DBO contract; (iii) support to enhance financial sustainability for WTE O&M, through implementation of an agreed O&M financing plan, including financial need forecasting and finalization of financing sources, revenue enhancement plan, responsibilities, and fund flow arrangements for payment of O&M; and (iv) public awareness campaigns on WTE and 3R benefits. The project will support PMU and government capacity to prepare, monitor, and manage sustainable WTE through consulting services for contract management, monitoring, supervision, and institutional development.

The project develops a modern regional waste management facility to treat current and future solid waste generated in the project area responding to a critical SWM service delivery gap. The WTE technology minimizes land requirements and produces renewable energy addressing the critical land and electricity constraints in the Maldives. Marketable incineration bottom ash recycling will also be promoted to further reduce landfill requirements and provide valuable inerts and metals for the construction industry. In line with lessons learnt from previous experience, the project (i) will employ 20-years O&M period in the WTE contract to ensure sustainable operations; (ii) has high readiness with 90% of total project amount under procurement;<sup>6</sup> (iii) will strengthen PMU and government capacity to monitor SWM service delivery through consulting services for contract management, monitoring, supervision, and institutional development; and (iv) will raise public understanding on WTE and sustainable 3R through awareness campaigns.

The project is estimated cost is \$151.13 million, including contingencies and financing charges. The government has requested (i) a grant not exceeding \$35.18 million from ADB's Special Funds resources (Asian Development Fund [ADF]); and (ii) a concessional loan of \$38.21 million from ADB's ordinary capital resources to help finance the project. The loan will have a 32-year term, including a grace period of 8 years; an interest rate of 1.0% per year during the grace period and 1.5% per year thereafter; and such other terms and conditions set forth in the draft loan and grant agreement. The government has also requested a loan not exceeding \$40.00 million from the Asian Infrastructure Investment Bank (AIIB) to help finance the project. The AIIB loan will be partially administered by ADB. The AIIB loan's terms and conditions will be described in a loan

---

<sup>6</sup> The project is part of a phased approach consisting of two projects including the Greater Malé Environmental Improvement and Waste Management Project and Greater Malé Waste to Energy Project. This is to match implementation capacity of government and improve project readiness for efficient resource allocation. This allowed for urgent measures to be implemented while complex WTE infrastructure prerequisite measures being prepared, including reclamation of 15 hectares of land and procurement process.



agreement between AIIB and the government. The Japan Fund for Joint Crediting Mechanism will provide grant cofinancing equivalent to \$10 million, to be administered by ADB.

## **B. Purpose of the EIA Study**

This EIA focuses solely on the WTE plant (inclusive of its ancillary facilities and landfill for disposal of WTE residues) as most environmentally sensitive component of GMWEP given its construction and operation is likely to have significant adverse environmental impacts that are irreversible, diverse, or unprecedented. These impacts may affect an area larger than the sites or facilities subject to physical works. Thus, GMWEP is classified as Category A for environment per ADB Safeguard Policy Statement (SPS) and an environmental impact assessment (EIA) is required.

The purpose of this EIA is to meet ADB SPS requirement for Category A projects and to comply with Government of Maldives requirements under EIA Regulations of 2012. This EIA also aims to inform decision-makers and the public of the environmental consequences of implementing the WTE plant. This EIA identifies, predicts, and analyzes impacts on the environment and people in the project area of influence. It also identifies alternatives and mitigation measures to reduce the environmental impact of the WTE plant. The EIA process also serves as an important procedural role in the overall decision-making process by promoting transparency and public involvement.

## **C. Scope of the EIA**

The scope of this EIA covers: (i) description of the WTE plant and ancillary facilities (the project); (ii) identification and description of the elements of the environment and community/stakeholders likely to be affected by the project and/or likely to cause adverse impacts to the project, including both the natural and man-made environment; (iii) information on the consideration of alternatives/options for design, site locations and layouts of the project to avoid and minimize potential environmental impacts to environmentally sensitive areas, other sensitive uses and sensitive receptors; to provide reasons for selecting the preferred option(s); (iv) description of environmental factors played in the selection of the preferred option(s); (v) identification and assessment of impacts on marine environment, groundwater, avifauna, biodiversity, air quality, water quality, waste management implication, land-based and marine traffic, socio-cultural and livelihood, occupational health and safety, landscape and visual; and determine the significance of impacts on sensitive receivers and potential affected uses; (vi) mitigation measures so as to minimize pollution, environmental disturbance and nuisance during construction and operation of the project; (vii) identification, prediction and evaluation of residual (i.e. after practicable mitigation) environmental impacts and the cumulative effects expected to arise during the construction and operation phases of the project in relation to the sensitive receivers and potential affected uses; (viii) identification, assessment and specification of methods, measures and standards, to be included in the detailed design, construction and operation of the project which are necessary to mitigate these environmental impacts and reducing them to acceptable levels; (ix) identification of constraints associated with the mitigation measures recommended in the EIA study and, where necessary, to identify the outstanding issues that need to be addressed in any further detailed EIA study; and (x) design and specifications in the environmental monitoring and audit requirements to ensure the effective implementation of the recommended environmental protection and pollution control measures.

## **D. Description of the Project**

**Components and implementation.** The WTE plant will have the following components: (i) two lines of moving grate incinerators, each with capacity of 250 TPD, and detailed components in

Table 1 below (per preliminary design as specified in the DBO bid document); (ii) bottom ash processing plant; (iii) air pollution control (APC) system including continuous emission monitoring systems (CEMS); (iv) landfill for residuals; (v) leachate treatment plant; and (vi) other allied components needed to operate the plant, including cooling water pipelines, access roads and drainage system, among others. The WTE plant will be developed and implemented under a design-build-operate (DBO) contract where the design-build period (or design phase and construction phase) is expected to be 4 years. The operation service period (or operation phase) is expected to be 20 years.

The project is designed for 10 MW power production, with 2 MW to be used for the facility itself (and other parasitic loads). The surplus power of 8 MW will be fed to the main grid through a cable link between Thilafushi island and Male or Ghule Fahlu. The government is still at planning stage of putting this link through a bridge (also at planning stage) to be constructed in between the islands. No definitive technical information about this cable and bridge is available as yet. Once information becomes available during the detailed design phase, updating of the EIA will include assessment of these proposed infrastructure facilities.

**Table 1: Details of the WTE Plant and Ancillary Facilities**

<b>Components</b>	<b>Requirements Per Preliminary Design</b>
Waste Reception, Storage and Feeding Facilities	The waste reception, storage and feeding process will have the mechanical equipment for the following process components: <ul style="list-style-type: none"> <li>• weighing system;</li> <li>• waste reception hall (tipping hall);</li> <li>• waste bunker;</li> <li>• waste cranes; and</li> <li>• supply of waste oil.</li> </ul>
Thermal System	<ul style="list-style-type: none"> <li>• Feeding hoppers, waste chute and waste feeder</li> <li>• Moving grate</li> <li>• Bottom ash collectors and discharge system</li> <li>• Combustion chamber</li> </ul>
Boiler and Water Steam System	Radiation and convection boiler passes including evaporator, super heaters and economizer, steam drum and all necessary sampling, venting, injection, blow-down and cleaning equipment, and others that will be needed for safe operations of the boiler and the water steam system
Air Pollution Control System	<ul style="list-style-type: none"> <li>• Flue gas cleaning</li> <li>• Nitrogen oxide removal system</li> </ul>
Turbine, Generator and Condenser	<ul style="list-style-type: none"> <li>• Steam turbine</li> <li>• Steam turbine with auxiliary equipment</li> <li>• four-pole rotor (1,500 min-1) Generator System</li> <li>• 2-flow seawater surface condenser</li> </ul>
Induced Draft Fan and Stack	<ul style="list-style-type: none"> <li>• Radial fan with a single-flow impeller, statically and dynamically balanced</li> <li>• Two stacks built as a tube-in-tube system, with minimum stack height of 45.7m (bidding document to require 50m)</li> </ul>
Continuous Emission Monitoring System	<ul style="list-style-type: none"> <li>• 1 CEMS for each stack</li> <li>• flue gas sampling points for emission measurements</li> </ul>
Condensate System	<ul style="list-style-type: none"> <li>• Condensate collecting system</li> <li>• Main condensate tank</li> </ul>

Components	Requirements Per Preliminary Design
	<ul style="list-style-type: none"> <li>• Boiler feed water pumps</li> <li>• Make-up water system</li> </ul>
Cooling Water Supply System	<ul style="list-style-type: none"> <li>• Sea water-cooled heat exchangers (mainly the condenser)</li> <li>• Pumps installed in an enclosed, water-tight area to cope with the climate change and disaster risks;</li> <li>• Pumps to be fully redundant</li> <li>• Pumps designed to accommodate the instant need to cool down the full steam flow rate bypassing the turbine</li> </ul>
Fuel and Chemical Supply and Storage	<ul style="list-style-type: none"> <li>• Tanks and silos shall be designed to prevent the occurrence of encrustation and deposits.</li> <li>• With monitoring equipment such as but not limited to leakage detection shall be installed for all hazardous substances.</li> <li>• All containers shall be equipped with manholes and associated maneuvering aids.</li> <li>• The manholes shall be opened without the aid of hoists.</li> <li>• Trays of containers shall be diverted appropriately via the channel and pumping sump.</li> <li>• For chemical containers, sufficient retention volume shall be provided.</li> </ul>
Piping and Valves	<ul style="list-style-type: none"> <li>• Installation lengths and connection dimensions of fittings shall be selected according to internationally recognized standards.</li> <li>• Fittings for insulated pipelines shall be equipped with spindle extensions, if necessary.</li> <li>• All fittings shall be supplied with a full corrosion protection (including the hand wheels and chain wheels) in the factory, in accordance with the customer's order.</li> <li>• Fittings and piping components shall be equipped with factory-specific markings.</li> </ul>
Pumps	<ul style="list-style-type: none"> <li>• Dry-mounted pumps with suitable base plates or base frames pre-assembled for installation including motor and coupling.</li> <li>• The material of the pumps shall be capable of continuous operation under the appropriate conditions of delivery and operation.</li> <li>• Pumps shall have a stable characteristic and shall allow a quick start from the cold conditions without prior warming.</li> <li>• Sliding ring seals of the pumps shall preferably be made of silicon carbide or wolfram carbide.</li> <li>• All pumps shall be provided with dry-running protection.</li> <li>• Pumps with a motor power of 20 kW shall have a bearing temperature monitor.</li> <li>• Suitable shut-off devices before and after the pumps shall be provided so that the pumps can be replaced at any time.</li> </ul>
Compressed and Instrument Air Supply	<ul style="list-style-type: none"> <li>• Design and install a fully redundant compressed air supply plant for the provision of dry, particle and oil-free compressed air that allows an energy optimized supply at 110% maximum continuous rating (MCR) of each incineration train.</li> </ul>
Thermal Insulation and Heat Protection	<ul style="list-style-type: none"> <li>• All equipment or components carrying media at elevated temperatures or at temperatures below ambient conditions or that, due to its operations, work at such temperatures shall be provided with thermal insulation.</li> </ul>

Components	Requirements Per Preliminary Design
	<ul style="list-style-type: none"> <li>• The thermal insulation design shall be in accordance with the requirements set in the contract documents.</li> <li>• The thermal insulation shall be designed so that the maximum temperature the working personnel are exposed to does not exceed 50 °C whenever feasible or shall install heat protection shields when the maximum surface temperature of any equipment which cannot be insulated exceeds 50 °C.</li> <li>• No asbestos shall be used for thermal insulation but only non-flammable, chemically and highly durable resistant rock wool mats that comply with internationally recognized standards.</li> <li>• The lagging and jackets shall meet the ambient conditions of the marine corrosive environment, accommodate the thermal expansion of pipes and equipment and that shall allow access to base materials, valves, fittings, flanges, measuring devices and other equipment.</li> </ul>
Lifting Devices	<ul style="list-style-type: none"> <li>• The WTE plant shall have all required lifting devices during the operations phase and shall provide either permanent or temporary (including attachments) lifting devices such as cranes and hoists.</li> <li>• The surrounding steel structure of the equipment shall be designed to allow anchoring or attaching temporary lifting gear if needed via mounting additional beams, clamps, shackles etc. or directly to the steel structure.</li> <li>• A permanent crane shall be installed in the turbine hall. Removable openings in the roof of the machinery hall shall allow the access via mobile cranes to lift larger components that cannot be moved otherwise.</li> </ul>

**Location.** The project will be located in Thilafushi, an island that has been reclaimed since December 1992 by dumping of wastes on the submerged “Thilafalhu” lagoon area. Thilafushi is located on the southern rim of North Malé atoll, and on the eastern line of atolls within the archipelago. Thilafushi is located in North Malé atoll, 9.5km from Malé. In terms of geographic coordinates, it is located at 04° 11' 00" N and 73° 26' 44" E. The nearest inhabited island is Villingili, approximately 7.1 km east of Thilafushi. The island was initially developed as a sand bank using dredged material from the Thilafushi Reef. Since then, land has been reclaimed by placing solid waste in dredged holes on the reef flat and later topping it up with fresh lagoon sand. This project will be located on a 27 hectares government-owned land, of which 15 hectares have been reclaimed from shallow lagoon. The old dumpsite will be closed and remediated when the WTE Plant becomes operational. The government has requested a loan not exceeding \$20 million from the Islamic Development Bank to finance the remediation of Thilafushi dumpsite.

## **E. National Environmental Law, Policy, Legal and Administrative Framework**

**Environmental protection in the Maldives.** The law governing the protection of the environment in the Maldives is the Environmental Protection and Preservation Act (EPPA) of 1993 (Act No 4/93). The law is brief and sets out the principles for sustaining and extending the benefits of the environment of the Maldives for the people and coming generations. The EPPA confers powers on the MOE to issue regulations and formulate policies for environmental protection and preservation.

**National Solid Waste Management Policy of 2008 and 2015.** The National Solid Waste Management Policy was developed in 2008, by the MOE, through consultations with the community and evaluation of existing waste management practices and scope for improved efficiency. The policy was then revised and adapted, and a new policy formulated and adopted in 2015. The policy is in line with government commitment to provide the resources required for waste management in all inhabited islands of the Maldives and is founded on the following 10 principles: (i) each person should be responsible for waste generated at the individual level and should comply with rules and regulations established locally; (ii) all household waste should be managed in accordance with the requirements of the local council; (iii) each inhabited island should prepare and submit an island waste management plan for the island; (iv) waste collection should be undertaken on a fee-based system for all waste producers, including households and industries; (v) agreements with government agencies in different inhabited islands to ensure management of waste in the islands; (vi) establishment of a waste management system in each inhabited island that is appropriate for the needs of the population and quantity and type of waste generated; (vii) establishment of RWMFs in each waste management zone; (viii) establishment of arrangements to transport all residual waste to a RWMF; (ix) promote adoption of waste management practices that generate revenue and to apply revenue to waste management at the island level; and (x) undertake waste management training and awareness campaigns at the national level.

**Waste Management Regulation (No. 2013/R-58).** The Waste Management Regulation of the Maldives was enacted under Article 3 of the EPPA in 2013 and is implemented by the Environmental Protection Agency. The regulation focuses on the following five areas: (i) waste management standards: defines standards for waste collection, transfer, treatment, storage, waste site management, landfills and managing hazardous waste; (ii) waste management permits: defines approval procedures for waste management sites; (iii) waste transfer: defines standards and permits required for waste transport on land and sea, including trans-boundary movements; (iv) reporting: defines reporting and monitoring requirements and procedures; and (v) enforcement: defines procedures to implement the regulations and penalties for non-compliance.

**Environmental assessment requirements.** Responsibilities and procedures for conducting environmental assessments, together with the requirements for environmental monitoring of projects, are set out in the EIA Regulations of 2012. All projects that may have an impact on the environment are referred to the Minister of Environment and Energy (EPPA 5[a]). The EIA Regulations assign primary responsibility for undertaking environmental assessment of projects to the project proponent and set out procedures, rights and responsibilities for the preparation and approval of EIAs. The EIA regulations include a schedule (Schedule D) of investment project types that require an EIA. For waste projects, these are landfills, waste incinerators and large-scale waste storage projects. The WTE plant is covered by Schedule D therefore an EIA is required.

**Health and safety.** Legislation covering occupational health and safety is currently included in the Employment Act (2008), Chapter 8 “Workplace Safety and Employer Health”. This requires employers to implement measures for the safety and protection of employees at the work place, including safe work place, procedures, safe equipment and materials, provision of protective equipment, safety training to employees, conducting health checks where work involves chemical or biological materials that may cause a hazard, providing medical care as well as first aid for employees injured while at work. The law also sets out employee’s obligations with regard to safety at work.

## F. Safeguard Requirements of Lenders and International Best Practices.

Financing support for the project will be sought from multilateral financial institutions, such as ADB and AIIB. This support requires adherence to international best practices and safeguard requirements of the lenders.

**ADB SPS.** The ADB SPS governs environmental and social safeguards of ADB's operations. It applies to all ADB-financed and/or ADB-administered projects and their components, regardless of the source of financing, including investment projects funded by a loan, and/or a grant, and/or other means, such as equity and/or guarantees. This project has been classified as Category A thus requiring an EIA. The project will comply with the ADB SPS requirements on stakeholders engagement, information disclosure, consultation and participation, grievance redressal mechanism, and monitoring and reporting.

**Applicable environmental, health and safety (EHS) guidelines.** During the design, construction, and operation of the project, pollution prevention and control technologies and practices consistent with international good practice, as reflected in internationally recognized standards such as, among others, the World Bank Group's EHS Guidelines and European Union Directives will be applied. These standards contain performance levels and measures that are normally acceptable and applicable to projects. When Government of Maldives regulations differ from these levels and measures, the project will achieve whichever is more stringent. If less stringent levels or measures are appropriate in view of the project circumstances, full and detailed justification will be provided for any proposed alternatives that are consistent with the requirements presented in ADB SPS.

## F. Description of the Environment

A 2-kilometer radial zone around the project site has been considered as the study area. Additionally, the adjacent island of Gulhifalhu where workers from Thilafushi reside is also included in the study area. Data collection period covers November 2016 to September 2019. Table 2 summarizes the baseline data on physical environment, ecological environment, and socio-economic environment. In August to September 2019, a socio-economic survey was conducted to obtain the baseline socio economic profile of the residents in Thilafushi and Gulhifalhu islands. The survey also determined the current waste disposal practices, the needs and willingness of the companies operating in the islands to pay for waste management services. The results were used as baseline for the EIA and in assessing the potential impacts to sensitive receptors in the island.

**Table 2: Summary of Baseline Conditions**

Parameters	Description
Existing condition	The location of the project is in the proximity of the dumpsite at Thilafushi, an industrial island with the oldest and largest landfill and numerous industrial companies. This project is being developed on 27 hectares of which 15 hectares have been reclaimed from shallow lagoon. The old dumpsite will be closed and remediated when the WTE Plant becomes operational. The government has requested a loan not exceeding \$20 million from the Islamic Development Bank to finance the remediation of Thilafushi dumpsite.
Land reclamation	Thilafushi Island has been developed as a solid waste landfill since December 1992. The island was initially developed as a sand bank using dredged material from the Thilafushi Reef. Since then, land has been reclaimed by placing solid waste in dredged holes on the reef flat and later topping it up with fresh lagoon sand. The island referred to as Thilafushi-1 was and is being reclaimed using this

Parameters	Description
	<p>method. A second island, zoned as Thilafushi-2 (where the project will be located), was reclaimed from lagoon sand. Subsequently a third island, Thilafushi-3, was initiated to reclaim 167 hectares of land from the remaining reef areas of Thilafushi.</p> <p>The reclamation works was undertaken by the government in anticipation of the WTE plant and was also subjected to an EIA process as part of the requirements of the Government of Maldives EIA Regulations of 2012. Reclamation works involved mainly filling and levelling activities. The land was reclaimed to a height of +1.5 m from mean sea level (MSL) from an average depth of -1.5 m above the sea floor. During preparation of this EIA, about 5% of the reclamation work is still being carried out to complete coastal protection structures around the newly reclaimed land. The finished ground level of the site will be at a level higher than the average ground level of the Thilafushi.</p>
Oceanographic conditions (bathymetry)	<p>The reef system of the Thilafushi Island comprises of an ocean ward reef flat, a lagoon ward reef and a central deep lagoon. The reef flat areas on the ocean ward side of the reef system (south of the proposed location) have a fairly flat depth ranging from -1.0 to -1.5m MSL. The reef system hosting Thilafushi does not host any other islands. The reef system is approximately 4.65 km long, 0.94 km wide (width of ring reef, including the lagoon area).</p>
Geology and topography	<p>The islands are low-lying Holocene features that began forming between 3000 and 5500 years ago. The islands represent the most recent deposition along a submarine plateau that is underlain by approximately 2,100 meters of mostly shallow-water carbonates resting on a slowly subsiding Eocene volcanic foundation. All islands of the Maldives are very low lying; more than 80% of the land area is less than 1 m above mean high tide level.</p>
Sediment quality	<p>The sediment regime around the present waste disposal area is likely to reflect the leaching of pollutants from the dumped wastes at the Thilafushi Island. As unplanned dumping of wastes on this island has the potential to contaminate sediments of the inner lagoon and outer reef flat area, six sampling stations were selected to get a representative status of the extent of contamination of the sediments due to the current waste disposal methods. Results of sediment analysis show no heavy metal (cadmium, lead, zinc, copper, chromium, nickel, mercury, arsenic) contamination.</p>
Climate and meteorology	<p>Regular meteorological observations and measurements in Maldives are limited to airports. A total of 12 airports are in operation, however meteorological observation takes place only on 5 airports. For the purposes of this EIA observations from the Velana International Airport at Hulhulhe, which is closest to the project site, will be used to describe the climate condition around the project area.</p> <p>The climate in Maldives is warm and humid, typical of the tropics. The average temperature ranges between 25°C to 30°C and relative humidity varies from 73 – 85%. The annual average rainfall is approximately 1,950mm. As the Maldives lie on or close to the equator, the islands of the Maldives receive plenty of sunshine throughout the year. Temperature is moderated by the presence of vast sea and oceans surrounding the small islands. The long-term average temperature ranges from 25°C to 31°C. With the influence of the monsoon, seasonal fluctuations are observed throughout the year. The warmest period is observed during March, April and May. The average annual rainfall for the archipelago is 2,124 mm.</p> <p>Monsoons of Indian Ocean govern the climatology of the Maldives. Two monsoon seasons are observed in Maldives: the Northeast (Iruvai) and the Southwest (Hulhangu) monsoon. The southwest monsoon lasts from May to</p>

Parameters	Description
	<p>September and the northeast monsoon occurs from December to February. The transition period of southwest monsoon, which is the driest part of the year, occurs between March and April while that of northeast monsoon occurs between October and November.</p> <p>The prevailing wind over the Maldives represents typical Asian monsoonal characteristics. The southwest monsoon, with winds predominantly between SW and NW, lasts from May to October. In May and June, winds are mainly from WSW to WNW, and in July to October, winds between W and NW predominate. The northeast monsoon, with winds predominantly from NE to E, lasts from December to February. During March and April, winds are variable. During November, winds are primarily from the west, becoming variable and can occasionally exceed 30 knots from the NE sector. However, yearly wind speed in the northeast and southwest monsoons are observed to be between 9-13 knots.</p>
Ambient air quality	<p>Ambient air quality monitoring was conducted to document the current baseline condition at the island. Three locations were selected at Thilafushi and one location at Villingili. Villingili is the nearest inhabited island and the sampling site at this island will serve as the control site for future monitoring activities under the project. The air quality monitoring activities were done for a period of one week each in 2018 and 2019.</p> <p>Ambient air quality monitoring was conducted at 4 locations. First station (AQ1) was selected in the downwind direction of the proposed project site (i.e. the potential direction of plume of smoke coming from the stack of the plant), and second station (AQ2) was placed at the crosswind direction of the plume. Third station (AQ3) was selected in the crosswind direction of the smoke plume from the existing dump site at Thilafushi. Fourth station (AQ4) was selected at Vilingili as a control site. Ambient air quality results obtained from the monitoring undertaken indicate that mixed results when compared with the WHO guidelines for ambient air quality.</p> <ul style="list-style-type: none"> <li>• The 24 hourly PM10 values recorded for the stations generally varied in the range of 4.0 - 690.0 <math>\mu\text{g}/\text{m}^3</math>. The mean values of PM10 recorded at AQ1, AQ2 and AQ4 were found to be in compliance with the WHO standard specified for such pollutant equivalent to 50 <math>\mu\text{g}/\text{m}^3</math>. However, the mean value of PM10 recorded at AQ3 is 88.4 <math>\mu\text{g}/\text{m}^3</math>, which exceeds WHO standard specified for such pollutant equivalent to 50 <math>\mu\text{g}/\text{m}^3</math>;</li> <li>• The 24 hourly PM2.5 values recorded for the stations generally varied in the range of 1.0 - 384.0 <math>\mu\text{g}/\text{m}^3</math>. The mean values for PM2.5 at AQ2 and AQ4 were found to be in compliance with the WHO standard specified for such pollutant equivalent to 25 <math>\mu\text{g}/\text{m}^3</math>. However, mean values for PM2.5 at AQ1 and AQ3 are 26.9 <math>\mu\text{g}/\text{m}^3</math> and 42.8 <math>\mu\text{g}/\text{m}^3</math>, respectively, which exceed WHO standard specified for such pollutant equivalent to 25 <math>\mu\text{g}/\text{m}^3</math>;</li> <li>• The 24 hourly SO2 values recorded for the stations generally varied in the range of 0.0 - 112.2 <math>\mu\text{g}/\text{m}^3</math>. The mean values for SO2 at AQ2 and AQ4 were found to be in compliance with the WHO standard specified for such pollutant equivalent to 20 <math>\mu\text{g}/\text{m}^3</math>. However, mean values for SO2 at AQ1 and AQ3 are 25.3 <math>\mu\text{g}/\text{m}^3</math> and 32.4 <math>\mu\text{g}/\text{m}^3</math>, respectively, which exceed WHO standard specified for such pollutant equivalent to 20 <math>\mu\text{g}/\text{m}^3</math>; and</li> <li>• The results of the 24-hourly standard values for NO2 have not been compared. WHO standards does not provide 24-hourly standard for NO2 to check for any possible non-compliances. However, if compared with the hourly averaging, the values are below the WHO standard of 200 <math>\mu\text{g}/\text{m}^3</math>.</li> </ul>



Parameters	Description
	Based on field visits and visual observations, the non-compliances for various parameters at different sampling locations in Thilafushi may be attributed to the continuous and instantaneous burning of wastes at the existing dumpsite. The government plans to stop fires on Thilafushi and start baling waste by July 2020 as interim SWM solution to stop open dumping until the WTE facility is commissioned. It is expected that once these measures are implemented the air quality at the sampling locations will improve.
Ambient Noise Level	Baseline ambient noise level measurements were conducted at the proposed WTE project site and selected locations in Thilafushi. Results show that noise level are within the WHO Guideline Values for Ambient Noise Level for both day time and night time.
Groundwater quality	Groundwater sampling was conducted from eight wells in Thilafushi. If compared with the National Drinking Water Quality Standards (NDWQS), water samples collected did not comply with parameters on coliform, total dissolved solids, iron, and manganese. If not treated, the groundwater is not an acceptable source of drinking water.
Avifauna	The island is frequented by birds including water birds. An IBAT was run to identify if there are bird species in the area listed as endangered or critically endangered. The IBAT run results show that there are no avifauna species considered as endangered or critically endangered in per IUCN list.
Marine water quality	Marine water quality sampling was conducted at seven (7) locations around Thilafushi island to determine the baseline conditions of the marine water around the project area. Qualitative and quantitative assessments were made, and laboratory analysis were done for heavy metals (As, Cr, Cu, Ni, Pb, Zn, Hg, Cd), Ammonia, nitrates, PH, Turbidity, Oil and Grease and BOD. Result show compliance with the Maldives Marine Water Quality Standards, except for very slight exceedance with pH.
Marine underwater ecology	<p>Marine underwater surveys were undertaken in 2018 at different locations around Thilafushi island. All surveys were carried out by underwater SCUBA diving. The marine surveys were carried out by surveyors who had been trained to undertake Reef Check surveys as outlined in the Reef Check Instruction Manual: A Guide to Reef Check Coral Reef Monitoring (2006). Based on the Guide to Reef Check Coral Reef Monitoring (2006), photo quadrat surveys were done in order to measure the benthic composition at the different sites. At each of the survey sites benthic composition and fish abundance was surveyed at depths of 5 meters and 10 meters. Results show varied findings. The highest coral cover was observed at the depth of 10 meters in site M2 adjacent to the current waste dumping area.</p> <p>Additional marine underwater surveys were undertaken in September 2019 at the proposed locations for the intake and discharge outfall of cooling water at the southern coastal boundary of the proposed project site. In this additional survey, reef profiling was included to identify the status of the coral reef in this area up to the depth of 30m. In particular, underwater survey was conducted to provide more in-depth information at three alternative sections of the where the intake and cooling water discharge outfall will be laid positioned. Results show that that at the depth of more than 20 meters, no corals and marine life exist.</p>
Natural hazards	The fragile ecological profile, low elevation, combined with its economic dependence on limited sectors makes Maldives highly vulnerable to natural hazards. The disaster risk profile of Maldives identifies earthquakes and tsunamis, cyclones/thunderstorms, floods (due to rain), drought (prolonged dry periods), storm surges, strong winds, and tornadoes (waterspouts) as critical disasters to the Maldives. Climate change further exacerbates the vulnerability of Maldives to these disasters. Most of these risk factors (apart from earthquakes, wind damage and rainfall flooding), stem from the extremely low elevation of all

Parameters	Description
	<p>Maldivian islands: the average elevation is 1.5 m above sea level. In spite of the occasional natural hazards, the Maldives are in general relatively free from high risk natural disasters.</p> <p>Thilafushi Island is in a moderate cyclonic hazard zone which has the potential for a maximum probable cyclonic wind speed of 69.6 knots. It has the potential for a 1.53 m storm tide in a 500-year return period. The disaster risk profile of Maldives places Thilafushi as being located in a severe tsunami risk zone with a probable maximum wave height between 3.2 and 4.5 m. The high levels of fluctuations of sea level during the Indian Ocean Tsunami showed that rising and falling of the water levels are enough to inundate any unprotected coastline of Maldives including Thilafushi Island. However, there are no records of major damages on the island. Thilafushi is protected from predominant swell waves. However, the island is still exposed to abnormal swell waves originating from intense storms in the southern hemisphere.</p>
Socio-economic conditions	<p>There are no communities/residential areas in Thilafushi. The island is industrial zone. A socio-economic survey was conducted in August to September 2019 as the Government of Maldives does not have an updated database that could describe the socio-economic conditions in the islands. Four hundred and thirty (430) individuals and 35 companies were surveyed across Thilafushi and Gulhifalhu Islands. Respondents were mainly located in Thilafushi. There are 319 individuals surveyed that stay in Thilafushi (accommodation provided by employers), 52 workers stay in Gulhifahu, and remaining workers live in Male and other islands. The individuals surveyed range from 18 to 67 years old and are mostly Muslims (81%) from Bangladesh (66%). Over 50% of the individuals surveyed are unskilled workers. None of those surveyed are believed to be involved in fishing activities. Most of the laborers and companies are aware of the health issues related to inadequate waste management. The employers surveyed believe that the present waste disposal practices in Thilafushi affect their health and the health of their employees. Moreover, 25 companies have stated their willingness to pay a higher amount than what they're currently paying for improved waste collection services. The survey found that smoke inhalation is perceived to be the main problem as the smoke can at times impair the visibility in Thilafushi. No fishing activities within the study area.</p>
Land use	<p>The land use system of Thilafushi was developed in an ad hoc manner without a master plan. Hence, the present land use patterns show a mixed approach to development.</p>
Health facilities	<p>Nearby healthcare facilities and hospitals are located in Malé. A health facility was opened in Thilafushi only recently in July 2019. However, the facilities and services offered are limited.</p>
Education facilities	<p>There is no evidence of education facilities on Thilafushi. Nearby schools, high schools and other education facilities are located in Malé.</p>
Commercial and industrial activities	<p>The major activities in Thilafushi are industrial activities, importing and stockpiling of construction materials and warehousing facilities, wholesale and retail trade, workshops and other industrial and commercial activities. There are more than 60 different companies established in Thilafushi, the number is more likely to get higher each year. There are both foreigners and locals employed in the island.</p>
Physical cultural resources	<p>No evidence of physical and cultural heritage could be found at Thilafushi. Similarly, no evidence of historical or archeological sites could be found at Thilafushi. Not present in the study area.</p>
Current use of land resources for traditional purposes	<p>No evidence of current use of land for traditional purposes could be found at Thilafushi.</p>

**Additional Baseline Data Gathering.** During the detailed design phase of the project, the baseline survey shall be conducted to include monthly baseline data on ambient air quality, and quarterly baseline data on marine water quality and marine underwater ecology. The DBO Contractor shall undertake progressive monitoring and sampling activities during this period to ensure robust baseline data and pre-works environmental conditions are documented. The results of the baseline survey are considered in the final detailed design of the project. In particular, the DBO Contractor shall:

- (i) undertake ambient air quality measurements, marine water quality analysis, and marine underwater ecology surveys for each season of the year at the identified sampling locations in this EIA report (and any other locations in and around Thilafushi island as may be deemed by the DBO Contractor as important sampling locations);
- (ii) follow required sampling methodologies and locations, including appropriate averaging time for ambient air quality measurements as indicated in the WHO Ambient Air Quality Guidelines; and
- (iii) include results of analyses in the updating of the EIA during the detailed design phase and consider these results in the final detailed design of the project as applicable.

#### **G. Analysis of Alternatives**

ADB SPS requires projects with potential significant adverse environmental impacts to undertake analysis of alternatives. This step will ensure all reasonable alternatives or options are taken into account, including the effect of a no project option scenario, and that these are examined towards minimizing impacts to the environment and allowing decision-makers to choose the best alternatives to protect and enhance environmental quality. The EIA has undertaken various alternatives analysis for the project for the (i) project technology; (ii) design capacity; (iii) air emission control; and (iv) sea water intake and discharge location.

**Project technology.** Analysis of the various SWM and treatment options has been undertaken. Due to space or land availability limitations in Thilafushi, the analysis suggested the adoption of technologically driven waste treatment option, which led to the selection of incineration technology. Subsequently, a second round of alternatives analysis was undertaken to determine which incineration technology will work in view of characteristics and volume of wastes, environmental quality standards, cost of technology, land requirement, and operation and maintenance requirements, among others. Ultimately, the moving grate incinerator technology was chosen as the best option due to its robustness and proven applications.

**Design capacity and Loading Conditions.** Based on the analyses of the waste composition and the various recycling scenarios undertaken by the feasibility study conducted by the Government, the following design values were considered for the WTE plant:

(i)	Design value (“nominal”)	8,000 KJ/kg
(ii)	Minimum value	6,500 KJ/kg
(iii)	Maximum value	9,500 KJ/kg

At the maximum value, it was assumed that high amounts of plastic are still contained in the garbage due to a lack of separation. Furthermore, it was taken into account that the water content of the organic waste is lower during the dry season. With the assumption of a throughput of 500

tons per day (21 tons per hour) and the above-mentioned calorific values, the thermal load range of the system is from 43.8 MW to 48.2 MW with potential net electricity output in the range of 6-8MW.

**Air emission control.** The flue gases discharged from the secondary combustion chamber are passed through various air pollution control systems for cleaning. The type of air pollution control systems provided depends on the desired level of cleaning. All commonly available dry or semi-dry flue gas cleaning systems including a bag-house filter can be used to meet the emission standards for heavy metals and acid and organic pollutants. Absorbents based on either lime or sodium bicarbonate/lime which are enriched with activated coke or carbon may be applied. The NO<sub>x</sub> removal may be effected either via a catalytic or non-catalytic reaction injecting ammonia or urea. For the proposed WTE plant any or all of the foresaid systems can be used international emission standards, in particular the emission limit values in Annex VI of Directive 2010/75/EU of the European Parliament and the Council (also referred to as EU Industrial Emission Directives).

**Sea water intake and discharge location.** The operation of the project will require the use of water for its cooling system, which will be drawn from the sea and then discharged back to the sea at an elevated temperature that is requested to be below 38°C. Discharge of this cooling water could potentially impact the underwater marine ecosystem in the area. An alternatives analysis was undertaken to identify the best section and location for the cooling water outfall. Based on proximity to the project site, three alternative locations have been identified and assessed. Underwater marine surveys were conducted to determine the extent of marine life, including the condition of the coral reefs, at these alternative sites. Results show that within those sites, no significant marine life and corals has been discovered. Hence, the cooling water discharge line may be located at any of these three locations without impacting any underwater marine ecosystem. As the final determining factor, the EIA has used the underwater topography profile in the three location to identify where the cooling water discharge line can be effectively laid at. The location with the least steep slope has been selected.

While the section through which the pipe will be laid has been identified, the depth of where to position the outfall (end of the discharge line) was also analyzed. A hot water (heat dissipation) dispersion modeling was carried out at various alternative depths. Results of the various simulations show that even at the worst-case scenario (shallowest depth of 10m), low discharge flow rate of the cooling water and high dilution around the water discharge outfall location would result to narrow temperature impact zone. However, as a precautionary measure, the EIA recommends the use of the best-case scenario in the modeling, which is to position the outfall at 30m depth.

**Intake.** The results of the underwater survey at the southern coastal section of the project site (M1, M8, M9, and M10) reveals no significant underwater marine life at these locations. This provides greater flexibility for the DBO Contractor to position the intake location of cooling water at any of these locations. However, in order to reduce impacts on the shoreline during construction phase, intake location will be positioned at the vicinity of Sections M1 and M8. This will ensure that construction of intake and discharge line structures, will be integrated and undertaken coherently at the same or close alignment and location. The recommended position of the inlet structure is described and shown in the EIA using the exact location coordinates and google earth map.

## **H. Potential Impacts of the Project**

The potential impacts have been identified and assessed through review of the project preliminary designs, discussion with the designers and experts involved in the project preparation, conduct of socio-economic survey, and stakeholders' consultations.

**Impact on marine environment.** The construction of the sea water intake and cooling water outfall is potential to impact the reef wall. The marine survey conducted on September 2019 in the designated location for the pipes reveal there no corals and marine life exist in the area and depth. The method of construction will involve conventional pipe installation where the pipes will be prepared on the construction site, floated the right position, sunk and anchored, which is common practice in the Maldives and requirements for contractors are in place. Therefore, the potential impact is not significant.

The project is not located within or adjacent any ecologically critical areas. The nearest identified marine protected area is the Lions Head diving site which is 1 km away from the project site. The discharge of cooling water from the WTE plant's cooling systems and brine from the desalination unit may affect this protected area and the marine environment. However, the volume of brine generated from the desalination unit is expected to be too small compared with the volume of cooling water discharge. The salinity of the cooling water discharge is expected to remain normal. As such, only the elevated temperature of cooling water discharge may impact the immediate and surrounding marine environment. A temperature dispersion (heat dissipation) modeling was carried out to assess the extent of influence of cooling water discharge temperature outwards from the outfall location. It was found that the low discharge flow rate of the cooling water and high dilution around cooling water discharge outfall location would result to low or minimal impact on the marine environment. Thus, the cooling water will not affect the Lion Head and surrounding marine environment.

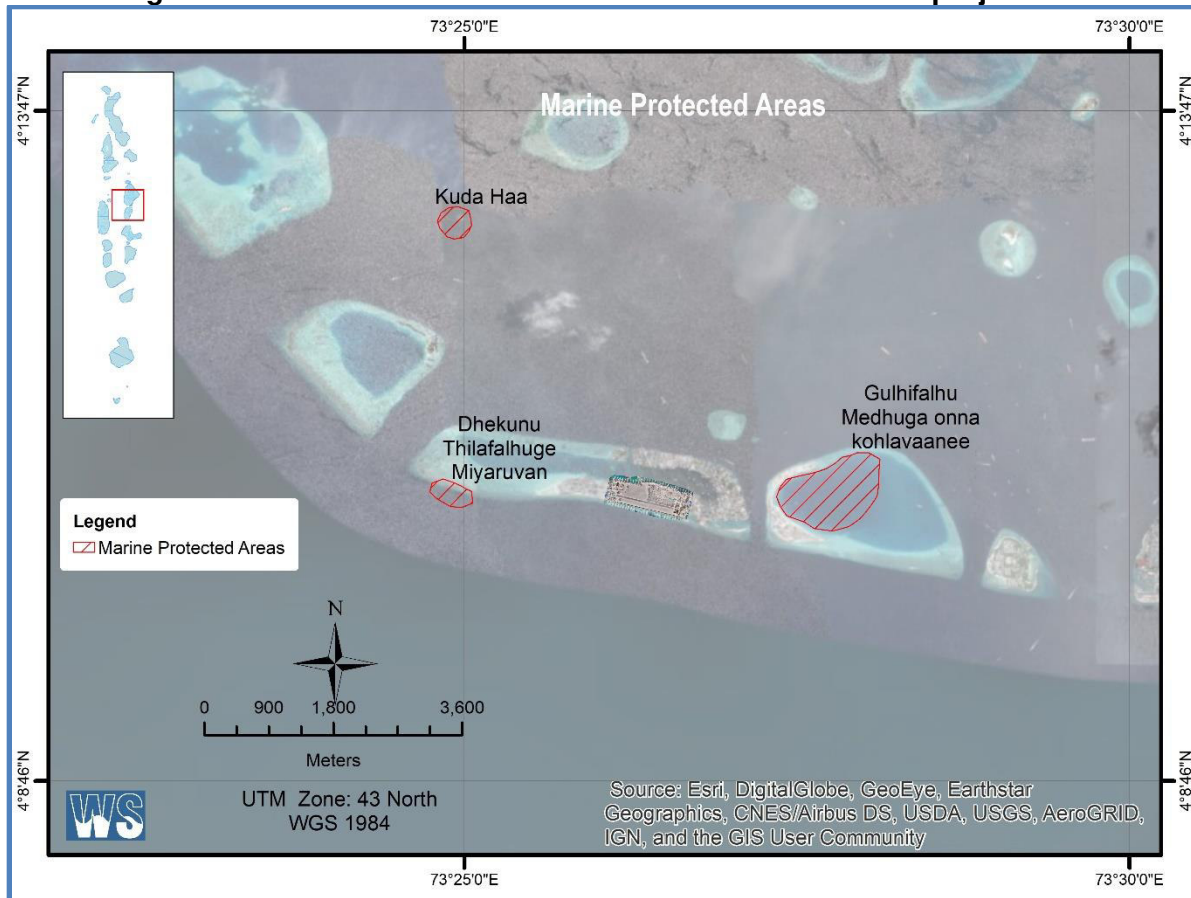
**Impact on groundwater.** The groundwater in Thilafushi has been tested and results show some parameters have been exceeded when compared with the National Drinking Water Standards. The construction phase and operation phase of the project will apply mitigation measures defined in the EMP of EIA report. During operation phase, the design shall ensure that leachate collection , treatment plant and wastewater treatment plant will be installed in order to mitigate impact to groundwater as discussed in this EIA report. The design considerations and the EMP will be included as part of DBO contract documents. Therefore, the potential impact is expected to be not significant.

**Impact on avifauna.** The birds attracted to the island as well as water birds that frequent surrounding waters will benefit from both the improved handling and treatment to remove hazardous fractions onto the landfill or into surrounding waters. The potential impact will be positive impact and for the long-term.

**Impact on biodiversity, protected areas and critical habitat.** There are no significant adverse impacts anticipated due to the operation of this project. The closing of the existing dumpsite will prevent scavenger birds from ingesting hazardous substance and plastic. The marine biodiversity at Thilafushi may also improve with the reduction of pollution. The nearest protected area within the 1km radial distance from the project site is the Lions Head dive site. The nearest boundary of this protected is about 950m or nearly 1km from the project site. The only aspect of the project operation that could potentially impact this protected area is the discharge of cooling water. However, based on analysis, this location of the protected area is too far to be affected by the cooling water discharge from the WTE plant.

According to Maldives EPA, there are 3 Marine Protected Areas (MPA) within 5km radius from the project site. They are; (i) Dhekunu Thilafalhuge Miyaruvani – this area is also referred to as Lions Head and is on the outside of the South Malé Atoll facing south into Vaadhoo Channel. (ii) Gulhifalhu Medhuga Onna Kollavaanee – this area is referred to as Hans Hass Place, which is the deep lagoon area at Gulhifalhu and (iii) Kuda Haa – isolated reef standing up from a sandy bottom at 30m, north to Giraavaru Island. In addition to the marine protected areas there are other areas that are also designated as ecologically sensitive areas in Kaafu atoll. However, none is located within 5 km radius of the project site.

**Figure 1: Marine Protected Areas within 5km radius of the project site**



Dhekunu Thilafalhuge Miyaruvani (also known as “Lions Head”) is the closest MPA to the project area. The edge of Lions Head is about 1 km from the project site’s boundaries. Lions Head is on the outside of North Malé Atoll facing south into Vaadhoo Channel. From the reef edge at about 8m there is a step down to a steep rubble slope where one can sit to watch the sharks. To the right (west) as one faces out is a large overhang that leads down to over 30 m depth. To the left (east) there is a line of small overhangs in 10-15m that continues for about 150 m. The Maldives EPA consider the Lions Head as a protected seascape (IUCN Category V) which covers ocean with a natural conservation plan which accommodates a range of for-profit activities. It has been a marine protected site since 01 October 1995. As Thillafushi and its surrounding area have undergone a transformational development in the past two decades, Maldives EPA is considering declassifying Lions Head from being a marine protected area to a more appropriate status reflecting current land use (industrial zone).

Gulhifalhu Medhuga Onna Kollavaanee (also known as “Hans Hass Place”) is on the outer reef of North Malé Atoll facing south into Vaadhoo Channel. It is an area about 100m long set back in a large recess in the reef. The reef top is at about 3m and drops vertically to a line of overhangs at 8-10m. The western end is marked by a large cavern at 10-15m. There are further overhangs at 20-25m. Hans Hass Place is named in honor of the great pioneer of diving in Maldives.

Kuda Haa is located about 4km north from the project site. It assumed that no direct impact will be caused to this MPA due to the distance and location.

Within the MPAs, activities such as anchoring (except in an emergency), coral and sand mining, dumping of waste, removal of any natural object or living creatures, fishing of any kind (with exception of traditional live bait fishing) and any other activity which may cause damage to the area or its associated marine life are prohibited under the Environment Act.

In order to assess whether the WTE project is located in a critical habitat, an initial screening was undertaken using the Integrated Biodiversity Assessment Tool (IBAT).<sup>7</sup> Results show that the location of the WTE project is likely a critical habitat. Therefore, a critical habitat assessment is needed to confirm the results. Critical habitat assessment ideally takes place across sensible ecological or political units that are sufficiently large to encompass all direct and indirect impacts from the project. These areas of analysis (AoAs) are thus often much broader than the direct project footprint. AoAs may be separate or combined, depending on the ecology of the biodiversity concerned. Considering the extent of potential impacts on aquatic biodiversity from the project, an aquatic AoA for the project was identified as the 50-km study area to make consistent with the default range in the IBAT Screening. This area is approximately within the Zone 3 of Maldives, within which common biological communities and/or management issues exist.

The critical habitat assessment considered if critical habitat-qualifying biodiversity candidates or species identified in the IBAT Screening are actually or potentially present within the AoA. The IFC Guidance Note 6 (2019)<sup>8</sup> has been used to identify if a certain biodiversity candidate or species can qualify the project AoA as Critical Habitat. Reasons are identified for each biodiversity feature likely meeting or not meeting Critical Habitat.

Results show that the AoA which encompasses the project site is likely to be a critical habitat only for a terrestrial insect (*Enallagma maldivense*). This insect normally thrives in freshwater habitats such as ponds. As the project is located in Thilafushi, an island with no freshwater body, it is highly unlikely that this insect is present within and around the island. More so that this insect is not found in the coastal areas and open seas surrounding Thilafushi island. However, as a precautionary measure, the critical habitat assessment and EIA recommend continuous monitoring around Thilafushi island to confirm the extent of biodiversity in various seasons of the year, including assessment of features pertinent to critical habitats. As part of the detailed design, the DBO contractor in coordination with PMU will be required to undertake additional biodiversity assessment around the project site. This is to ensure pre-construction works conditions and

<sup>7</sup> The Integrated Biodiversity Assessment Tool (IBAT) is a multi-institutional programme of work involving BirdLife International, Conservation International, IUCN, and UNEP-WCMC. IBAT provides a basic risk screening on biodiversity. It draws together information on globally recognised biodiversity information drawn from a number of IUCN’s Knowledge Products: IUCN Red List of Threatened Species, Key Biodiversity Areas (priority sites for conservation) and Protected Planet/The World Database on Protected Areas (covering nationally and internationally recognised sites, including IUCN management categories I–VI, Ramsar Wetlands of International Importance and World Heritage sites).

<sup>8</sup> [https://www.ifc.org/wps/wcm/connect/5e0f3c0c-0aa4-4290-a0f8-4490b61de245/GN6\\_English\\_June-27-2019.pdf?MOD=AJPERES&CVID=mRQjZva](https://www.ifc.org/wps/wcm/connect/5e0f3c0c-0aa4-4290-a0f8-4490b61de245/GN6_English_June-27-2019.pdf?MOD=AJPERES&CVID=mRQjZva)

biodiversity risks are considered in the design, construction and operation, and to examine and mitigate the potential impacts of the project on areas significant for biodiversity. In cases when future information determines the existence of critical habitat, the WTE project should be able to demonstrate that:

- (i) It does not lead to measurable adverse impacts on those biodiversity values for which the critical habitat was designated, and on the ecological processes supporting those biodiversity values;
- (ii) It does not lead to a net reduction in the global and/or national/regional population of any Critically Endangered or Endangered species over a reasonable period of time; and
- (iii) It has integrated into its management program a robust, appropriately designed, and long-term biodiversity monitoring and evaluation program.

**Impact on air quality.** Impact to air quality during construction phase are similar to impacts expected from other construction activities elsewhere, which can be mitigated through good international construction and engineering practices. All mitigation measures to avoid all these situations are included in the EMP. Based on the detailed design, the DBO Contractor shall update the EMP and develop its site-specific EMP (SEMP) following applicable international best practices that will include World Bank's EHS Guidelines on Construction and Decommissioning Activities.<sup>9</sup>

During operations phase, measures to avoid impacts on air quality include selecting best technology for incineration, integration of APC system and stack height. Municipal waste incineration produces various pollutants that can affect air quality and human health. These pollutants are released through two specific waste products of incineration process known as bottom ash and fly ash. These wastes can include a combination of various heavy metals, dioxins and furans, and other persistent organic pollutants. Specifically, fly ash is the more hazardous waste product due to size and density that can go airborne with the combustion gases when released to the atmosphere and impact air quality.

Heavy metals and dioxin and furans are highly toxic compounds which when inhaled or ingested by humans may in the long term cause cancer and neurological damage, congenital malformations and infant mortality, respiratory illnesses, etc. Hence, it is paramount that the adoption of incineration technology has to come with it an accompanying APC technology or process which will enable efficient recovery of these toxic pollutants. However, even with the most advanced technologies to date, complete removal of these toxic substances in the flue gases is difficult to achieve. It is for this reason that good international industry practices and standards, such as the emission standards in Annex VI of Directive 2010/75/EU of the European Parliament and the Council, are established to ensure emissions from these specific facilities do not impact the ambient conditions of the environment. Concomitantly, height of stack from where emissions should be discharged needs to be calculated and followed to ensure pollutants from emissions do not degrade the ground level ambient air quality. Air dispersion modeling is normally used to simulate how air pollutants disperse in the atmosphere and to analyze the potential impacts of these pollutants to ambient air quality given specific project and site information.

For the WTE plant, dispersion modeling carried out using AUSTAL2000 showed that the emission (with the proposed flue gas cleaning), would have no additional harmful impact on the surrounding

---

<sup>9</sup> IFC World Bank Group. 2007. Environmental, Health, and Safety (EHS) Guidelines – General EHS Guidelines: Construction and Decommissioning.



environment, particularly with regard to dust precipitation, sulfur dioxide, nitrogen oxides, fluorine and mercury deposition. In view of the perceived impact of emission from this type of project to ambient air quality, the air dispersion modeling was re-run using a different air dispersion model (AERMOD) as a confirmatory measure of the EIA. The modeling run using AERMOD also confirmed similar findings of AUSTAL2000 that no significant impact on the surrounding environment. AERMOD modeled the dispersion of parameters, including other parameters not screened by AUSTAL2000 such as ammonia, dioxins and furans, and group of heavy metals. With these findings, a significant negative impact on ambient air quality is not expected. Results in comparison with internationally recognized standards such as WHO and USEPA are presented in the EIA report.

While air dispersion modeling shows the WTE operation will not bring significant impact to ambient air quality in Thilafushi island, the DBO Contractor shall ensure all measures are still appropriately integrated into the detailed design of the project. Air emissions from the incineration will depend on the specific waste composition and the presence and effectiveness of air pollution control systems. Polluting emissions may include carbon dioxide (CO<sub>2</sub>), CO, NO<sub>x</sub>, sulfur dioxide (SO<sub>2</sub>), particulate matter, ammonia, amines, acids (HCL, HF), VOCs, dioxins/furans, polychlorinated biphenyls (PCBs), polycyclic aromatic hydrocarbons (PAHs), metals (Hg), and sulfides, etc., depending on the waste content and combustion conditions. During the detailed design, the DBO Contractor shall consider all applicable measures recommended by the European Union Best Available Technique Reference (BREF) documents 2018,<sup>10</sup> or the World Bank EHS Guidelines on Waste Management Facilities,<sup>11</sup> whichever is applicable and meaningful for the project. Subject to practicality and project circumstances, the project will consider the following examples of measures to prevent, minimize, and control air emissions:

- (i) Conduct of waste segregation and/or presorting, subject to feasibility or practicality, by collaborating with the waste supplier to avoid incineration of wastes that contain metals and metalloids that may volatilize during combustion and be difficult to control through air emission technology (e.g., mercury and arsenic);
- (ii) Follow applicable national requirements and internationally recognized standards for incinerator design and operating conditions, mainly rapid quenching of the flue gas after leaving all combustion chambers and before entering any dry particulate matter air pollution control device but also combustion temperature, residence time, and turbulence.<sup>12</sup> Standards for stationary incinerators which include temperature and afterburner exit gas quenching (i.e. rapid temperature reduction) requirements are preferred in order to nearly eliminate dioxins and furans. In case where rapid quenching is not practical for the WTE plant, follow applicable national requirements and internationally recognized standards for incinerator design and operating conditions, such as combustion temperature, residence time, turbulence, and reduced residence time of dust laden exhaust gases in the temperature range of 450 to 200 degrees Celsius;
- (iii) Introduce wastes into the incinerator only after the optimum temperature is reached in the final combustion chamber;

<sup>10</sup> [https://eippcb.jrc.ec.europa.eu/reference/BREF/WI/WI\\_BREF\\_FD\\_Black\\_Watermark.pdf](https://eippcb.jrc.ec.europa.eu/reference/BREF/WI/WI_BREF_FD_Black_Watermark.pdf)

<sup>11</sup> IFC World Bank Group. 2007. Environmental, Health, and Safety (EHS) Guidelines For Waste Management Facilities.

<sup>12</sup> For example, according to Article 6 of EU Council Directive 2000/76, the gas resulting from the incineration process should be raised, after the last injection of combustion air to a temperature of 850 degrees Celsius (1,100 degrees Celsius for hazardous wastes with a content greater than 1% of halogenated organics) for a period of two seconds. Additional details on operating conditions are provided in this reference. Other sources of emissions standards include the U.S. EPA regulations for air emissions from stationary sources at 40 CFR Part 60.

- (iv) The waste charging system should be interlocked with the temperature monitoring and control system to prevent waste additions if the operating temperature falls below the required limits;
- (v) Minimize the uncontrolled ingress of air into the combustion chamber via waste loading or other routes;
- (vi) Optimize furnace and boiler geometry, combustion air injection, and, if used, NO<sub>x</sub> control devices using flow modeling;
- (vii) Optimize and control combustion conditions by the control of air (oxygen) supply, distribution and temperature, including gas and oxidant mixing; the control of combustion temperature level and distribution; and the control of raw gas residence time;
- (viii) Implement maintenance and other procedures to minimize planned and unplanned shutdowns;
- (ix) Avoid operating conditions in excess of those that are required for efficient destruction of the waste;
- (x) Use auxiliary burner(s) for start-up and shutdown and for maintaining the required operational combustion temperatures (according to the waste concerned) at all times when unburned waste is in the combustion chamber;
- (xi) Use a boiler to transfer the flue-gas energy for the production of electricity and/or supply of steam/heat, if practical;
- (xii) Use primary (combustion-related) NO<sub>x</sub> control measures and/or selective catalytic reduction (SCR) or selective noncatalytic reduction (SNCR) systems, depending on the emissions levels required;
- (xiii) Use flue gas treatment system for control of acid gases, particulate matter, and other air pollutants;
- (xiv) Minimize formation of dioxins and furans by ensuring that particulate control systems do not operate in the 200 to 400 degrees Celsius temperature range; identifying and controlling incoming waste composition; using primary (combustion-related) controls; using designs and operation conditions that limit the formation of dioxins, furans, and their precursors; and using flue gas controls; and
- (xv) Consider the application of waste-to-energy technologies to help off-set emissions associated with fossil fuel-based power generation.<sup>13</sup>

#### **Additional Measures to Mitigate Impacts on Ambient Air Quality During Operation Phase.**

- (i) **Offset Activities Within Thilafushi.** The government plans to stop fires on Thilafushi and start baling waste by July 2020 as interim SWM solution to stop open dumping until the WTE facility is commissioned. It is expected that once these measures are implemented the air quality at the sampling locations will improve. The rehabilitation of the existing dumpsite will have the end view of shutting down the operation of the dumpsite and finally stopping the smoke emanating from it. This activity will serve as the biggest offset to substantially reduce the impact of the WTE plant operation to ambient air quality. Monitoring the benefits of this offset will continue throughout the operation phase and included in the environmental monitoring plan developed in this EIA report.

---

<sup>13</sup> The possibility of applying waste-to-energy technologies depends on a number of issues which may include the project design specifications established by local government as well as laws applicable to the generation and sale electricity. Also, it should be noted that recycling options may often save more energy than what is generated by incineration of mixed solid waste in a waste-to-energy facility.

- (ii) **Use of cleaner fuels or technologies.** The DBO Contract includes performance guarantees on use of cleaner fuels and technologies that have already been proven in other countries. These performance guarantees will ensure that the WTE plant will comply with the emission standards.

**Impact on marine water quality.** Impacts on the marine environment during the construction will largely be from the construction of the berth and the discharge pipes for cooling water from the incinerator and the utilities such as sewerage and brine from desalination. The berth is proposed to be located at the enclosed lagoon in the island. Excavation in the area will result in sedimentation. As this semi-enclosed area is quite stagnant, settlement rate will be higher than an area with regular currents and water flow. However, all mitigation measures to avoid all these situations are included in the EMP. During operation phase, the design shall ensure that leachate treatment plant and wastewater treatment plant will be installed in order to mitigate impact to marine water as discussed in this EIA report. The design considerations and the EMP will be included as part of DBO contract documents. Therefore, the potential impact is expected to be not significant.

The marine survey conducted for this EIA shows that this area mostly consists of rock and rubble and hardly any live coral. Therefore, impacts for coral due to sedimentation is negligible. The discharge pipes will be directed towards the South into deep sea. As some live corals are located in this area, according to the marine survey, pipes will be laid during calm sea conditions, with as much care as is feasible.

Sea vessels can cause risks of water pollution, in the events of leaks and spills of fuel, lubricants, hydraulic fluids or other fluids used for vehicle operation. Although this area is already contaminated, care will be taken to mitigate the risks and impacts of any spills. Mitigation measures for these impacts are included in the EMP.

**Impact on waste management.** Waste generation will be expected during the construction phase. Expected wastes will include packaging of construction materials, equipment, fuels, lubricants, food and some rubble where existing structures need to be demolished, if any. Mitigation measures for handling and disposal of these wastes are included in the EMP. Some specialist lubricants and paint may be hazardous. These will also be disposed of at the appropriate locations following the measures in the EMP. For toxic materials, approvals must be obtained from appropriate agency prior to importing materials rated as hazardous under the Globally Harmonized System of Classification and Labelling of Chemicals. Therefore, the potential impact is not significant.

**Impact on land-based and marine traffic.** The project will not need any special considerations regarding location since the project is easily accessible through the use of exclusive landing ports and delivery areas not used by local workers or other industries in Thilafushi. As there are few vehicles on Thilafushi, there will be no significant impact on land-based traffic. All vehicle and heavy equipment movements during construction phase will only be limited within the boundary of the project site.

Delivery of construction equipment and raw materials may increase marine traffic in the area. In order to avoid this impact, all delivery of equipment during mobilization phase and raw materials for the construction activities will be utilizing the exclusive docking ports for the project, which are near or adjacent the project site. These docking ports are where current solid wastes are unloaded from various parts of Project area. With this scheme, it is expected that no marine traffic and port congestion are expected that will affect the locator industries and workers on the island. A marine

route for project construction mobilization has been prepared. Therefore, potential impact on land-based and marine traffic is not significant.

**Impact on socio-cultural and livelihood.** No social impacts pertaining to land loss, land fragmentation, physical displacement, loss of income, loss of productive land, potential income loss for fishermen and preventing fishing related activities and fishing routes.

Based on the results of the socio-economic survey, sensitive receptors were assessed if the project has influence, impact or control over them. Assessment of the results of the survey show that the project will not have impact or control over their welfare, status of employment or livelihood. Therefore, potential impact on socio-cultural and livelihood is not significant.

**Impact on community and occupational health and safety.** Impacts and risks for community and occupational health and safety are associated with heavy equipment in trafficked areas. The DBO contractor will be required to appoint a full-time environmental health and safety managers and maintain a pool of trained engineers to ensure the effective implementation of both environmental and occupational health and safety measures at the project site. The DBO Contractor shall establish its health and safety plan to be adopted at the site following international best practices. The DBO contractor has the responsibility to provide labor camps for migrant workers, and sufficient space for equipment, construction materials, consumables, and other supplies that will be required during construction phase. Therefore, the potential impact on community and occupational health and safety is not significant.

During the detailed design phase, the DBO Contractor shall integrate international good practices on community and occupation health and safety in its construction methods and practices, such those included in Section 4.2 of World Bank EHS Guidelines on Construction and Decommissioning activities (footnote 9). Minimum requirements shall be the following:

### **Community Health and Safety**

- (i) implement risk management strategies to protect the community from physical, chemical, or other hazards associated with sites under construction and decommissioning;
- (ii) restricting access to the site, through a combination of institutional and administrative controls, with a focus on high risk structures or areas depending on site-specific situations, including fencing, signage, and communication of risks to the local community;
- (iii) removing hazardous conditions on construction sites that cannot be controlled affectively with site access restrictions, such as covering openings to small confined spaces, ensuring means of escape for larger openings such as trenches or excavations, or locked storage of hazardous materials; and
- (iv) implement measure to prevent proliferation of vectors of diseases at work sites;
- (v) adequate space and lighting, temporary fences, shining barriers and signage at active work sites;
- (vi) contractor's preparedness in emergency response;
- (vii) adequate dissemination of GRM and contractor's observance and implementation of GRM; and
- (viii) upon availability, local people should be given an opportunity for work in the subproject activities.

### **Occupational Health and Safety**

- (i) Communication and Training
  - (a) Training of all workers on occupational health and safety prior to construction works;
  - (b) Conduct of orientation to visitors on health and safety procedures at work sites;
  - (c) Signages strategically installed to identify all areas at work sites, including hazard or danger areas;
  - (d) Proper labeling of equipment and containers at construction and storage sites; and
  - (e) Suitable arrangements to cater for emergencies, including: first aid equipment; personnel trained to administer first aid; communication with, and transport to, the nearest hospital with an accident / emergency department; monitoring equipment; rescue equipment; firefighting equipment; and communication with nearest fire brigade station;
  
- (ii) Physical Hazards
  - (a) Use of personal protective equipment by all workers such as earplugs, safety shoes, hard hats, masks, goggles, etc. as applicable, and ensure these are used properly;
  - (b) Avoidance of slips and falls through good house-keeping practices, such as the sorting and placing loose construction materials or demolition debris in established areas away from foot paths, cleaning up excessive waste debris and liquid spills regularly, locating electrical cords and ropes in common areas and marked corridors, and use of slip retardant footwear;
  - (c) Use of bracing or trench shoring on deep excavation works;
  - (d) Adequate lighting in dark working areas and areas with night works;
  - (e) Rotating and moving equipment inspected and tested prior to use during construction works. These shall be parked at designated areas and operated by qualified and trained operators only;
  - (f) Specific site traffic rules and routes in place and known to all personnel, workers, drivers, and equipment operators; and
  - (g) Use of air pollution source equipment and vehicles that are well maintained and with valid permits;
  
- (iii) General Facility Design and Operation
  - (a) Regular checking of integrity of workplace structures to avoid collapse or failure;
  - (b) Ensuring workplace can withstand severe weather conditions;
  - (c) Enough workspaces available for workers, including exit routes during emergencies;
  - (d) Fire precautions and firefighting equipment installed;
  - (e) First aid stations and kits are available. Trained personnel should be available at all times who can provide first aid measures to victims of accidents;
  - (f) Secured storage areas for chemicals and other hazardous and flammable substances are installed and ensure access is limited to authorized personnel only;
  - (g) Good working environment temperature maintained;

- (h) Worker camps and work sites provided with housekeeping facilities, such as separate toilets for male and female workers, drinking water supply, wash and bathing water, rest areas, and other lavatory and worker welfare facilities; and
- (i) Maintain records and make reports concerning health, safety and welfare of persons, and damage to property. Take remedial action to prevent a recurrence of any accidents that may occur.

Similarly during the detailed design phase, the DBO Contractor shall integrate international good practices on community and occupation health and safety in its operation of the WTE, such those included in World Bank EHS Guidelines on Waste Management Facilities (footnote 11). The most significant occupational health and safety impacts typically associated with workers at waste management facilities occur during the operational phase and include accidents and injuries, chemical exposure, and exposure to pathogens and vectors. Minimum requirements shall be the following:

**Accidents and Injuries.** Physical hazards encountered at waste management facilities are similar to those at other large industrial projects. Solid waste workers are particularly prone to accidents involving trucks and other moving equipment, so traffic management systems and traffic controllers are recommended. Accidents include fires, explosions, being caught in processing equipment, and being run over by mobile equipment. Other injuries occur from heavy lifting, contact with sharps, chemical burns, and infectious agents. Smoke, dusts, and bioaerosols can lead to injuries to eyes, ears, and respiratory systems.<sup>14</sup> In addition to other standard measures adopted in most industrial facility operations, appropriate procedures following international best practices are recommended to prevent, minimize, and control accidents and injuries at the WTE plant and associated facilities.

**Chemical Exposure.** Chemical hazards encountered at waste management facilities are similar to those at other large industrial facilities, such as toxic and asphyxiating gases, and are addressed in the General EHS Guidelines. However, the full composition of wastes and their potential hazards is often unknown. Even municipal solid waste (MSW) often contains hazardous chemicals, such as heavy metals from discarded batteries, lighting fixtures, paints, and inks. Appropriate procedures following international best practices are recommended to prevent, minimize, and control chemical exposure at the WTE plant and its associated facilities.

**Pathogens and Vectors.** Workers can be exposed to pathogens contained in manure and animal excreta found in MSW from the disposal of sludge, carcasses, diapers, and yard trimmings containing domestic animal waste. Uncontrolled dumping of MSW attracts rats, flies, and other insects that can transmit diseases. Processing of MSW can also generate bioaerosols, suspensions of particles in the air consisting partially or wholly of microorganisms, such as bacteria, viruses, molds, and fungi. These microorganisms can remain suspended in the air for long periods of time, retaining viability or infectivity. Workers may also be exposed to endotoxins, which are produced within a microorganism and released upon destruction of the cell and which can be carried by airborne dust particles. The following measures are recommended to prevent, minimize, and control pathogens and vectors at the WTE plant and its associated facilities:

- (i) Provide and require use of suitable personal protective clothing and equipment;
- (ii) Provide worker immunization and health monitoring (e.g., for Hepatitis B and tetanus);

---

<sup>14</sup> Refer to Cointreau. S. (2006) for additional information.

- (iii) Maintain good housekeeping in waste processing and storage areas;
- (iv) Use automatic (non-manual) waste handling methods if practical;
- (v) Clean and wash with disinfectant the cabins of heavy mobile equipment used at regular intervals;
- (vi) Use integrated pest-control approaches to control vermin levels, treating infested areas, such as exposed faces and flanks with insecticide, if necessary;
- (vii) Provide and require use of dust masks or respirators under dry and dusty conditions. Charcoal-filled respirators also reduce odor perception;
- (viii) Provide prompt medical attention for cuts and bruises. Cover open wounds to prevent contact with the incoming loads or feedstock;
- (ix) Fully enclose the waste management site with fencing so that no livestock or wildlife is able to come in contact with the waste, which contains significant potential to enable the spread of livestock and zoonotic disease, as well as spillover disease to wildlife. Provide daily cover of wastes to minimize the attraction to birds, which can become infected with avian influenza and other bird diseases that can then be carried off-site.

**General Occupational and Environmental Health Issues Associated with Waste Scavenging.** The presence of informal sector workers laboring in municipal or mixed waste disposal sites in search of commercially valuable materials is a common place occurrence in developing countries. The causes and dynamics are the result of complex social, cultural, labor, and economic factors that are clearly outside of the scope of this guidance document. However, the following principles, if applicable, should be considered in managing the occupational, health, and safety risks at the WTE site and its associated facilities:

- (i) Waste scavenging should not be allowed under any circumstances in hazardous and non-hazardous industrial waste management facilities;
- (ii) Facilities dedicated to the management of MSW should work with government entities in the development of simple infrastructure that can allow for the sorting of waste, helping groups of scavengers form cooperatives or other forms of micro-enterprises, or formally contracting them to provide this function. The outright displacement of scavenging workers as an occupational health and safety management strategy, without the provision of viable alternatives, should be avoided;
- (iii) Operators of existing facilities with scavenging workers should exercise commercially viable means of formalizing their work through the creation of management programs that include:
  - (a) Allowing only registered adults on the site, excluding children and domestic animals. Striving to provide alternatives to access to childcare and education to children;
  - (b) Providing protective gear, such as shoes, face masks, and gloves;
  - (c) Arranging the disposal layout and provide sorting facilities to improve access to recyclables while reducing their contact with other operations, thus minimizing potential hazards;
  - (d) Providing water supply for washing and areas for changing clothes;
  - (e) Implementing education campaigns regarding sanitation, hygiene, and care of domestic animals;
  - (f) Providing a worker health surveillance program including regular vaccination and health examinations.

**Physical, Chemical, and Biological Hazards.** Visitors and trespassers at waste management facilities may be subject to many of the hazards described for site workers. Exhaust fumes of waste collection trucks traveling to and from disposal sites, dust from disposal operations, and open burning of waste all contribute to potential occupational health problems.<sup>15</sup> Recommended measures to prevent, minimize, and control physical, chemical, and biological hazards to the community around the WTE site include:

- (i) Restrict access to waste management facilities by implementing security procedures, such as:
  - (a) Perimeter fencing of adequate height and suitable material, e.g. chain link, stock proof palisade;
  - (b) Lockable site access gate and buildings;
  - (c) Security cameras at key access points linked to recording equipment and remote access CCTV, where required;
  - (d) Security alarms fitted to buildings and storage areas;
  - (e) Review of site security measures annually or whenever a security breach is reported;
  - (f) Use of a site visitor register;
  - (g) Immediate repair of fencing/access points if damaged; and
  - (h) Lighting of site during night time where necessary. As this may cause light nuisance to neighbors, the lighting installations should be selected to minimize ambient light pollution.

**Construction Camp Site and Workers Accommodation During Operations.** The construction camp site and accommodation of workers shall be established following international best practices to ensure welfare of workers is protected.<sup>16</sup> The DBO Contractor shall consider the following requirements, whichever are applicable or practical depending on site situation in Thilafushi, in building these camps and accommodation facilities at the site, if any.

- (i) The temporary campsite location should:
  - (a) Be free from any risk of flooding.
  - (b) Be sited a reasonable distance and have clear physical separation from any construction work, equipment and/or machinery.
  - (c) Provide clear separation between the camp and construction area through such means as a footpath, fence, etc.
  - (d) Where possible, be sited outside the boundary of the construction zone.
- (ii) The site design should ensure:

<sup>15</sup> Sandra Cointreau, The World Bank Group, Occupational and Environmental Health Issues of Solid Waste Management Special Emphasis on Middle- and Lower-Income Countries, Urban Papers UP-2, July 2006.

<sup>16</sup> From the draft Construction Code of Practice developed for urban development projects in Kathmandu, Nepal. This COP was developed with reference to the following: "Workers' accommodation: processes and standards: A guidance note by IFC and EBRD", IFC and EBRD, 2009 [https://www.ebrd.com/downloads/about/sustainability/Workers\\_accomodation.pdf](https://www.ebrd.com/downloads/about/sustainability/Workers_accomodation.pdf); and "Malaysian standards of temporary construction site workers' amenities and accommodation – code of practice. (MS 2593, 2015) [http://www.sirim.my/srhc/documents/Aug-Sept-2014/12D024R0\\_PC.pdf](http://www.sirim.my/srhc/documents/Aug-Sept-2014/12D024R0_PC.pdf)



- (a) Adequate space to accommodate the number of workers throughout the project period, for accommodation, meals, toilets, bathing, etc.
  - (b) Considerations for needs of all types of workers: e.g. women, local laborers or travelers, etc.
  - (c) Adequate drainage is provided to prevent any stagnant water which can attract mosquitos and vermin and spread disease among workers,
  - (d) Buildings are structurally sound and can withstand wind and rain.
  - (e) Ensure that the worker camp area will have adequate ground surfacing (e.g. gravel, wood sheeting, grass) such that residents may move freely between buildings in their off time without walking through mud and water.
  - (f) Designated area for small fires during colder months, located a safe distance from buildings and any flammable materials.
- (iii) The workers' accommodation should comply with the following requirements:

#### Dimensions and Design

- (a) The height of room shall not be less than 2.4 meters.
- (b) The sleeping area or resting area shall not be less than 3 m<sup>2</sup> per person.
- (c) Separate bed for each worker provided, with minimum of 1 meter space between each bed.
- (d) Separate sleeping areas are provided for men and women, except in family rooms if needed.
- (e) Sleeping area should be separate from cooking/canteen areas, and far enough distance from toilets to avoid odors.
- (f) Where possible, prefab-type structures could be considered.

#### Light and Air

- (a) Both natural and artificial lighting are provided and maintained in living facilities. It is best practice that the window area represents not less than 5% to 10% of the floor area. Emergency lighting is provided.
- (b) For cold weather months, accommodation must be such that the temperature is kept at a level of around 20 degrees Celsius notwithstanding the need for adequate ventilation.
- (c) In warmer months, adequate ventilation (either cross-ventilation and/or fans) is provided.

#### Materials

- (a) Roofing materials must be such that the structure can withstand high winds without risk of collapse, and be leak-free during rainy season.
- (b) Flooring material should be easily cleanable and free of bare nails or other sharp objects.

#### Provisions/furnishing

- (a) Each worker is provided with a comfortable mattress, pillow, cover and clean bedding.
- (b) Double or triple-deck bunk beds are prohibited. Double deck bunks may be used in special circumstances but must be approved by the Engineer.

- (c) Each resident is provided facilities for the storage of personal belongings, such as a locker or shelving unit.
  - (d) Every resident is provided with adequate furniture such as a table, a chair, a mirror and a bedside light (small solar lights may be a good option). These may be shared among several workers.
  - (e) Separate storage provided for work boots and PPE. Drying/airing areas may need to be provided for PPE depending on conditions.
  - (f) Mosquito nets are provided in areas where mosquitos are present and/or at the request of workers.
  - (g) Rubbish bin with cover provided in each room and emptied regularly.
  - (h) Electrical outlets provided for charging mobile phones, radio, etc. Ensure that electrical wiring is done properly and presents no risk of electrical fire.
  - (i) All doors and windows should be lockable and be provided with mosquito screens.
- (iv) The workers kitchen area should comply with the following requirements:
- (a) The minimum area of kitchen should be not less than 4.5 m<sup>2</sup> and the minimum width should be more than 1.5 meters.
  - (b) Adequate height of kitchen should be not less than 2.25 meters.
  - (c) Provide where clean drinking water is always available – ensure that any open water tanks are covered.
  - (d) Kitchens are provided with facilities to maintain adequate personal hygiene including a sufficient number of washbasins designated for cleaning hands with clean water and materials for hygienic hand-drying.
  - (e) In order to enable easy cleaning, it is good practice that cooking stoves are not sealed against a wall, and benches and fixtures are not built into the floor.
  - (f) Design should consider if the kitchen within the camp will be used to service all workers for all meals (e.g. meals prepared for day laborers as well as residents) or will be limited to self-preparation of meals by residents.
  - (g) Wall surfaces adjacent to cooking areas are made of fire-resistant materials.
  - (h) Food preparation tables are equipped with a smooth, durable, easily cleanable, non-corrosive surface made of non-toxic materials.
  - (i) All cupboards and other fixtures have a smooth, durable and washable surface.
  - (j) All kitchen floors, ceiling and wall surfaces adjacent to or above food preparation and cooking areas are built using durable, non-absorbent, easily cleanable, non-toxic materials.
  - (k) Cooking gas canisters provided
  - (l) Fire extinguisher provided outside of cooking area.
  - (m) Rubbish bin(s) provided with cover
  - (n) Adequate facilities for cleaning, disinfecting and storage of cooking utensils and equipment are provided.
- (v) The workers toilets should comply with the following requirements:
- (a) Toilets should be located within same general area as accommodation, but at least 30 meters away from sleeping area/kitchen. Should not be more than 60m away.

- (b) Toilets should be located at least 30 meters away from any water wells.
  - (c) An adequate number of toilets should be provided to workers. Standards range from 1 unit per 15 persons to 1 unit per 6 persons.
  - (d) Toilet rooms shall be located so as to be accessible without any individual having to pass through any sleeping room
  - (e) Toilet dimensions should be at least 1.5 m × 0.75 m (minimum width)
  - (f) Toilet facilities should be installed so as to prevent any odors reaching dining facilities or sleeping areas.
  - (g) Separate facilities provided for men and women.
  - (h) An adequate number of handwash facilities is provided to workers. Standards range from 1 unit per 15 persons to 1 unit per 6 workers. Handwash facilities should consist of a tap and a basin, soap and hygienic means of drying hands.
  - (i) Toilets should be constructed such that they are structurally sound during high winds and free from leaks during rains.
  - (j) Every toilet should be provided with natural lighting and natural ventilation by means of  $\geq 1$  openings, providing a total area of  $>0.2 \text{ m}^2$  per toilet. Such openings shall be capable of allowing a free, uninterrupted passage of air.
  - (k) In addition, all toilet rooms should be well-lit, with natural lighting and artificial lights at night.
  - (l) Ensure no discharge of toilets and showers that will contaminate water sources or common areas
  - (m) Sanitary and toilet facilities are designed to provide workers with adequate privacy, including ceiling to floor partitions and lockable doors
  - (n) Ensure toilets have rubbish bin in each cubicle
- (vi) The shower and washing facilities should comply with the following requirements:
- (a) An adequate number of shower facilities is provided to workers. Standards range from 1 unit per 15 persons to 1 unit per 6 persons.
  - (b) Shower/bathing facilities are provided with an adequate supply of clean water.
  - (c) Separate facilities for men and women.
  - (d) The flooring for shower facilities should be of hard washable materials, damp-proof and properly drained.
  - (e) Suitable light, ventilation and soap should be provided.
  - (f) Adequate space and hooks must be provided for hanging clothes/towels while bathing.
  - (g) Area for washing/drying clothes provided, including washbasin, soap and drying lines. Either piped water to the basin or standpipe for filling basins should be within close distance.
  - (h) Ensure area drains well and doesn't create a muddy environment.
- (vii) Optional Amenities and Other Good Practices that should be followed as applicable:
- (a) Paint the camp buildings to present a tidy and satisfactory appearance – this will help encourage workers to keep their camp in good condition.
  - (b) Provide signage in kitchen area, canteen, toilets, and other common areas to encourage good hygiene practices, cleanliness of kitchen and personal

spaces, worker conduct, worker responsibilities, safety evacuation plan, etc.

- (c) Involve laborers in design of the camp, e.g. to get their inputs on siting of buildings, and any specific needs of women.

**Impact due to land acquisition or resettlement.** There will be no land acquisition and no private property will be affected. Therefore, no impact is envisaged.

**Impact on landscape and visual.** Creation of a vegetation buffer-zone along the coast near the project site and landfills would provide a natural protection of odor and blends into island aesthetic. The WTE plant will have a waste reception hall that shall comply with environmental, health and safety, and operational requirements. Odor emissions shall be prevented by a draft induced by the primary air supply fan. Entry and exit gates shall be closed by an electrically driven fast acting shutter with an airtight design. The dimension of the reception hall shall allow for safe flow of incoming and exiting vehicles. The WTE plant will have all necessary spaces dedicated for equipment, vehicles and waste storage during the operation phase. Therefore, potential impact is not significant.

**Residual impacts (i.e. after practicable mitigation).** The residual wastes from the waste incineration are bottom ash, slag and the residues from flue gas. Bottom ash and slag is a valuable fraction which may potentially be used for many purposes such as covering material for landfill, ballast layer or reinforcement layer in road construction or filler/aggregate for construction blocks. Under any circumstances that these options are not feasible, the sanitary landfill will be able to accommodate the residual wastes. The hazardous residues from the flue gas cleaning (fly ash) will be handled separately from the bottom ash following the APC Residue or Fly Ash Management Plan included in this EIA report (see below fly ash management). With reference to the waste characteristics, the wastes have the potential to contain hazardous substances. Therefore, both the bottom ash and fly ash may likewise contain these hazardous substances that could impact the environment if no sufficient measures are taken to contain them. In order to avoid this impact, the DBO Contractor shall design the landfill facility by applying international best practices on landfilling of hazardous wastes, such as the relevant requirements indicated in the EU Directive on the Landfill of Wastes.<sup>17</sup> Below table summarizes these requirements.

**Table 3: General Requirements for Hazardous Waste Landfills**

Design Parameters	Design Considerations and Requirements
Water control and leachate management	Appropriate measures shall be taken, with respect to the characteristics of the landfill and the meteorological conditions, in order to: <ul style="list-style-type: none"> <li>(i) control water from precipitations entering into the landfill body,</li> <li>(ii) prevent surface water and/or groundwater from entering into the landfilled waste,</li> <li>(iii) collect contaminated water and leachate,</li> <li>(iv) treat contaminated water and leachate collected from the landfill to the appropriate standard required for their discharge following the guaranteed effluent quality that the DBO Contractor shall comply as stated in this EIA report.</li> </ul>
Protection of soil and water	The landfill must be situated and designed so as to meet the necessary conditions for preventing pollution of the soil, groundwater or surface water and ensuring efficient collection of leachate as and when required. Protection of soil, groundwater and surface water is to be achieved by the combination of a geological barrier and a

<sup>17</sup> Council Directive 1999/31/EC of 26 April 1999 on the Landfill of Waste.

Design Parameters	Design Considerations and Requirements																											
	<p>bottom liner during the operational/active phase and by the combination of a geological barrier and an impermeable bottom liner during the operational/active phase and by the combination of a geological barrier and a top liner during the passive phase/post closure.</p> <p>The geological barrier is determined by geological and hydrogeological conditions below and in the vicinity of a landfill site providing sufficient attenuation capacity to prevent a potential risk to soil and groundwater.</p> <p>The landfill base and sides shall consist of a mineral layer which satisfies permeability and thickness requirements with a combined effect in terms of protection of soil, groundwater and surface water at least equivalent to the one resulting from the following requirements:</p> <ul style="list-style-type: none"> <li>- landfill for hazardous waste: <math>K \leq 1.0 \times 10^{-9}</math> m/s; thickness <math>\geq 5</math> m,</li> </ul> <p>Where the geological barrier does not naturally meet the above conditions, it can be completed artificially and reinforced by other means giving equivalent protection. An artificially established geological barrier should be no less than 0.5 meters thick.</p> <p>In addition to the geological barrier described above a leachate collection and sealing system must be added in accordance with the following principles so as to ensure that leachate accumulation at the base of the landfill is kept to a minimum.</p> <table border="1" data-bbox="430 957 1409 1184" style="margin-left: auto; margin-right: auto;"> <caption style="text-align: center;"><i>Leachate collection and bottom sealing</i></caption> <thead> <tr> <th style="text-align: center;">Landfill category</th> <th style="text-align: center;">non hazardous</th> <th style="text-align: center;">hazardous</th> </tr> </thead> <tbody> <tr> <td>Artificial sealing liner</td> <td style="text-align: center;">required</td> <td style="text-align: center;">required</td> </tr> <tr> <td>Drainage layer <math>\geq 0,5</math> m</td> <td style="text-align: center;">required</td> <td style="text-align: center;">required</td> </tr> </tbody> </table> <p>If the DBO Contractor finds that the prevention of leachate formation is necessary, a surface sealing may be prescribed. Recommendations for the surface sealing are as follows:</p> <table border="1" data-bbox="430 1314 1409 1642" style="margin-left: auto; margin-right: auto;"> <thead> <tr> <th style="text-align: center;">Landfill category</th> <th style="text-align: center;">non hazardous</th> <th style="text-align: center;">hazardous</th> </tr> </thead> <tbody> <tr> <td>Gas drainage layer</td> <td style="text-align: center;">required</td> <td style="text-align: center;">not required</td> </tr> <tr> <td>Artificial sealing liner</td> <td style="text-align: center;">not required</td> <td style="text-align: center;">required</td> </tr> <tr> <td>Impermeable mineral layer</td> <td style="text-align: center;">required</td> <td style="text-align: center;">required</td> </tr> <tr> <td>Drainage layer <math>&gt; 0,5</math> m</td> <td style="text-align: center;">required</td> <td style="text-align: center;">required</td> </tr> <tr> <td>Top soil cover <math>&gt; 1</math> m</td> <td style="text-align: center;">required</td> <td style="text-align: center;">required.</td> </tr> </tbody> </table>	Landfill category	non hazardous	hazardous	Artificial sealing liner	required	required	Drainage layer $\geq 0,5$ m	required	required	Landfill category	non hazardous	hazardous	Gas drainage layer	required	not required	Artificial sealing liner	not required	required	Impermeable mineral layer	required	required	Drainage layer $> 0,5$ m	required	required	Top soil cover $> 1$ m	required	required.
Landfill category	non hazardous	hazardous																										
Artificial sealing liner	required	required																										
Drainage layer $\geq 0,5$ m	required	required																										
Landfill category	non hazardous	hazardous																										
Gas drainage layer	required	not required																										
Artificial sealing liner	not required	required																										
Impermeable mineral layer	required	required																										
Drainage layer $> 0,5$ m	required	required																										
Top soil cover $> 1$ m	required	required.																										
Nuisances and hazards	<p>Measures shall be taken to minimize nuisances and hazards arising from the landfill through:</p> <ul style="list-style-type: none"> <li>- emissions of odors and dust,</li> <li>- wind-blown materials,</li> <li>- noise and traffic,</li> <li>- birds, vermin and insects,</li> <li>- formation and aerosols,</li> <li>- fires.</li> </ul>																											

Design Parameters	Design Considerations and Requirements
	The landfill shall be equipped so that dirt originating from the site is not dispersed onto public roads and the surrounding land.
Stability	The emplacement of waste on the site shall take place in such a way as to ensure stability of the mass of waste and associated structures, particularly in respect of avoidance of slippages. Where an artificial barrier is established it must be ascertained that the geological substratum, considering the morphology of the landfill, is sufficiently stable to prevent settlement that may cause damage to the barrier.
Barriers	The landfill shall be secured to prevent free access to the site. The gates shall be locked outside operating hours. The system of control and access to each facility should contain a program of measures to detect and discourage illegal dumping in the facility.

**Fly Ash Management.** To avoid any impact to the environment and to the DBO Contractor's personnel safety, the fly ash shall be conditioned safely in sealed bags and disposed in a controlled way at the residual waste landfill. Similarly, the fly ash collected from flue gas cleaning is cooled down, stored in big bags and disposed in the same residual waste landfill. The DBO Contractor shall follow the APC Residue or Fly Ash Management Plan attached in this EIA report. The DBO Contractor shall update the plan accordingly during the design phase, with the condition that no requirements therein shall be relaxed or removed. Consistent with this APC Residue or Fly Ash Management Plan, the DBO Contractor's design shall consider the following for conveying and loading APC residues or fly ash:

- (i) APC residues or fly ash shall not be mixed with bottom or boiler ash prior to the bottom ash treatment;
- (ii) APC residues or fly ash shall be conveyed in closed conveying systems that end up in storage silos whose exhaust air can be dedusted via a central dedusting system;
- (iii) The top of the bag filter housing shall be enclosed and shall be connected to the central dedusting system (while pulling/replacing bag-filter hoses);
- (iv) Discharging the APC residues or fly ash from the silos into water-tight jumbo bags (with inlet) or into the transfer vehicles shall be carried out via dust-tight discharging chutes;
- (v) APC residues or fly ash shall be treated by either stabilization/solidification or via triggered pozzolanic reaction prior to landfilling to limit the leachability of heavy metals; and
- (vi) Landfilling of contained APC residues or fly ash shall follow the standards of landfilling hazardous wastes based on EU Directive on the Landfill of Wastes as discussed in Table 3 above.

**Cumulative effects.** As of the assessment, there are no other similar planned projects that will be established or put up in Thilafushi or adjacent islands. Therefore, the WTE plant will not contribute to any cumulative negative impact with other sources of similar impacts in Thilafushi, and/or any existing project or condition, and/or other project-related developments that are realistically defined at the time the assessment. The future plan of the project to expand by 50% will not have any cumulative negative effects because it will instead address the potential environmental impact of increased solid waste generation in the future. Nevertheless, a strategic environmental assessment will be undertaken in the future to evaluate the cumulative and other

potential environmental impacts of future SWM projects in Thilafushi, and Maldives in general, including the planned expansion of the WTE plant by 50%.

**Greenhouse gas emissions.** The operation of the WTE Plant will be a potential source of greenhouse gas emissions due to the inherent combustion processes involved in plant operations. This GHG emission poses a potential transboundary impact on endangered species and habitats. However, comparing with the current practice of landfilling solid wastes in Maldives, the incineration process will greatly reduce the volume of the waste that need to be disposed in sanitary landfills. Therefore, the production of greenhouse gases due to landfilling will be reduced. The WTE plant will generate electricity for the industries on Thilafushi, replacing their dependence on fossil fuel use for power generation (most of electricity is powered by diesel). Summing these all leads to an overall reduction of greenhouse gas emission by the Maldives. A complete accounting and analysis of GHG emission by the WTE Project resulted to GHG emission reduction of 40,000 tCO<sub>2</sub>e/year, which is the average annual reduction across the project life cycle.

## I. Environmental management plan

A number of measures have been proposed to mitigate the impacts on the environment during the design, construction and operation phases of the project. The bid document requires the DBO contractor to meet the following performance requirements related to safeguards:

**Table 4: WTE Plant Performance Requirements Per DBO Bid Document Related to Environmental Safeguards**

Parameters	Performance Requirements <sup>a</sup>
1. Performance Guarantee (PG) 6: Total organic carbon-content bottom ash (TOC)	The Contractor shall ensure that the annual averaged TOC content of bottom ash shall be less than 3.0% by weight while none of the samples shall be with a TOC greater than 3.5%. The average TOC content shall be determined by analyzing two representative samples monthly (i.e. approximately one sample every 15 days). None of the measured TOC contents shall exceed 3.5% by weight dry matter. Measurement of TOC according to British Standard EN 131317. Six samples per year tested by external accredited laboratory.
2. PG 7: Temperature of cooling water outlet	The Contractor shall design and build the plant so that the cooling water outlet temperature shall be less than 38 degree Celsius and discharged at the section and depth (30 meters) as recommended in this EIA report.
3. PG 8: Air emission standards	The Contractor shall operate the plant so that none of the half hourly and none of the daily aggregated pollutants' measurements and none of the discontinuously measured pollutants' concentrations exceed the emission limit values stipulated in Annex VI of Directive 2010/75/EU of the European Parliament and the Council (Technical Provisions Relating to emission standards for waste incineration plants and waste co-incineration plants any time. Measurement will be done thru CEMS and calibrated every third year (at least) by an accredited laboratory or certification agency.
4. PG 9: Combustion conditions	The Contractor shall ensure that combustion conditions (temperature = 850 degrees Celsius for at least 2 seconds residence time) are maintained at all times. The requirements as per Chapter 5.16 (Tests on Completion of Design-Build) of the bidding document shall be considered, which specifies the trial operations and performance guarantees test. Combustion conditions include the need for proof by Contractor of maintaining the temperature and residence time, by

Parameters	Performance Requirements <sup>a</sup>																																																																							
	<p>submitting a methodology for how to validate that residence time and temperatures are kept under most unfavorable conditions.</p> <p>Combustion conditions shall be met any time during tests to be done on the completion of WTE plant construction and thereafter.</p>																																																																							
<p>5. PG 10: Leachate treatment plant (LTP) discharge standards</p>	<p>The maximum permissible concentrations of pollutants discharged from the LTP into the environment are specified in the bidding document, which lists the following effluent limits that should be complied with:</p> <table border="1" data-bbox="561 506 1408 1171"> <thead> <tr> <th colspan="2">Parameters</th> <th>unit</th> <th>Limit</th> </tr> </thead> <tbody> <tr> <td>Chemical Oxygen demand</td> <td>COD</td> <td>mg/l</td> <td>200</td> </tr> <tr> <td>Biological Oxygen demand</td> <td>BOD<sub>5</sub></td> <td>mg/l</td> <td>20</td> </tr> <tr> <td>Total Inorganic Nitrogen</td> <td>N<sub>tot, inorg</sub></td> <td>mg/l</td> <td>70</td> </tr> <tr> <td>Nitrite</td> <td>NO<sub>2</sub>-N</td> <td>mg/l</td> <td>2</td> </tr> <tr> <td>Sulfide</td> <td>S</td> <td>mg/l</td> <td>1</td> </tr> <tr> <td>Total Phosphate</td> <td>P<sub>tot</sub></td> <td>mg/l</td> <td>3</td> </tr> <tr> <td>Lead</td> <td>Pb</td> <td>mg/l</td> <td>0.5</td> </tr> <tr> <td>Cadmium</td> <td>Cd</td> <td>mg/l</td> <td>0.05</td> </tr> <tr> <td>Total Chromium</td> <td>Cr</td> <td>mg/l</td> <td>0.5</td> </tr> <tr> <td>Chromium (VI)</td> <td>Cr VI</td> <td>mg/l</td> <td>0.1</td> </tr> <tr> <td>Mercury (total)</td> <td>Hg</td> <td>mg/l</td> <td>0.02</td> </tr> <tr> <td>Nickel</td> <td>Ni</td> <td>mg/l</td> <td>1</td> </tr> <tr> <td>Zinc</td> <td>Zn</td> <td>mg/l</td> <td>2</td> </tr> <tr> <td>Copper</td> <td>Cu</td> <td>mg/l</td> <td>0.5</td> </tr> <tr> <td>Arsenic</td> <td>As</td> <td>mg/l</td> <td>0.1</td> </tr> <tr> <td>Conductivity at 25°C*</td> <td>-</td> <td>μS/ cm</td> <td>2,500</td> </tr> </tbody> </table> <p>*used to monitor the performance of the LTP only</p>				Parameters		unit	Limit	Chemical Oxygen demand	COD	mg/l	200	Biological Oxygen demand	BOD <sub>5</sub>	mg/l	20	Total Inorganic Nitrogen	N <sub>tot, inorg</sub>	mg/l	70	Nitrite	NO <sub>2</sub> -N	mg/l	2	Sulfide	S	mg/l	1	Total Phosphate	P <sub>tot</sub>	mg/l	3	Lead	Pb	mg/l	0.5	Cadmium	Cd	mg/l	0.05	Total Chromium	Cr	mg/l	0.5	Chromium (VI)	Cr VI	mg/l	0.1	Mercury (total)	Hg	mg/l	0.02	Nickel	Ni	mg/l	1	Zinc	Zn	mg/l	2	Copper	Cu	mg/l	0.5	Arsenic	As	mg/l	0.1	Conductivity at 25°C*	-	μS/ cm	2,500
Parameters		unit	Limit																																																																					
Chemical Oxygen demand	COD	mg/l	200																																																																					
Biological Oxygen demand	BOD <sub>5</sub>	mg/l	20																																																																					
Total Inorganic Nitrogen	N <sub>tot, inorg</sub>	mg/l	70																																																																					
Nitrite	NO <sub>2</sub> -N	mg/l	2																																																																					
Sulfide	S	mg/l	1																																																																					
Total Phosphate	P <sub>tot</sub>	mg/l	3																																																																					
Lead	Pb	mg/l	0.5																																																																					
Cadmium	Cd	mg/l	0.05																																																																					
Total Chromium	Cr	mg/l	0.5																																																																					
Chromium (VI)	Cr VI	mg/l	0.1																																																																					
Mercury (total)	Hg	mg/l	0.02																																																																					
Nickel	Ni	mg/l	1																																																																					
Zinc	Zn	mg/l	2																																																																					
Copper	Cu	mg/l	0.5																																																																					
Arsenic	As	mg/l	0.1																																																																					
Conductivity at 25°C*	-	μS/ cm	2,500																																																																					
<p>6. PG 11: Wastewater treatment discharge standards</p>	<p>The maximum permissible concentrations of pollutants discharged from the wastewater treatment plant into the environment are specified in the following table of effluent limits:</p> <table border="1" data-bbox="561 1360 1408 1696"> <thead> <tr> <th colspan="2">Parameters</th> <th>unit</th> <th>Threshold Value</th> </tr> </thead> <tbody> <tr> <td>Chemical Oxygen demand</td> <td>COD</td> <td>mg/l</td> <td>150</td> </tr> <tr> <td>Biological Oxygen demand</td> <td>BOD<sub>5</sub></td> <td>mg/l</td> <td>40</td> </tr> <tr> <td>Suspended Solids</td> <td>-</td> <td>mg/l</td> <td>100</td> </tr> <tr> <td>Ammonia-N</td> <td>NH<sub>4</sub></td> <td>mg/l</td> <td>15</td> </tr> <tr> <td>Total N</td> <td>N</td> <td>mg/l</td> <td>30</td> </tr> <tr> <td>N-hexane extract (mineral oils, grease)</td> <td>-</td> <td>mg/l</td> <td>10</td> </tr> </tbody> </table>				Parameters		unit	Threshold Value	Chemical Oxygen demand	COD	mg/l	150	Biological Oxygen demand	BOD <sub>5</sub>	mg/l	40	Suspended Solids	-	mg/l	100	Ammonia-N	NH <sub>4</sub>	mg/l	15	Total N	N	mg/l	30	N-hexane extract (mineral oils, grease)	-	mg/l	10																																								
Parameters		unit	Threshold Value																																																																					
Chemical Oxygen demand	COD	mg/l	150																																																																					
Biological Oxygen demand	BOD <sub>5</sub>	mg/l	40																																																																					
Suspended Solids	-	mg/l	100																																																																					
Ammonia-N	NH <sub>4</sub>	mg/l	15																																																																					
Total N	N	mg/l	30																																																																					
N-hexane extract (mineral oils, grease)	-	mg/l	10																																																																					
<p>7. PG 12: Sound pressure level</p>	<p>Sound pressure levels shall not exceed the 80 dBA at 1 min distance from the emitting source and different sound pressure levels at the site boundary: 70 dBA from 0700 to 2200 hours and 50 dBA from 2200 to</p>																																																																							



Parameters	Performance Requirements <sup>a</sup>
	0700 hours. Measurement will be in-situ using decibel meter. Frequency of measurement specified in the EMP.

<sup>a</sup> Performance standards from the Maldives Environmental Protection Agency and international guideline values as specified in EU Directives are compared and whichever is more stringent is applicable.

The DBO contractor shall consider the particular environment and location of the WTE plant and shall pay particular attention shall be included, but not limited, to the (i) air emissions and dust control; (ii) noise and vibration control; (iii) effluent management; (iv) waste management; (v) hazardous substance handling and storage management, including spill contingency; (vi) erosion, soil and vegetation management; (vii) traffic management; (viii) recruitment and labor management, including the skills development and local procurement; (ix) flooding and natural hazards; and (x) storm water management.

A set of waste characteristics have been specified in the bid document. While the design waste as shown in Table 4 indicates the design criteria for the thermal unit and the APC system, the plant shall perform as set forth in the stoker capacity diagram that defines the throughput (between 70 and 110% of the nominal throughput) and the NCV range (6.5 and 9.5 MJ/kg) for which the plant shall be operated without any auxiliary fuel. Waste that is outside this performance window can be incinerated though but it may be rejected and returned to the supplier.

**Table 5: Design Waste Characteristics for the WTE Plant**

Parameter	Limit
Net Calorific Value (NCV)	8.000 kJ/kg
Combustible	40 %
Water	31 %
Ash	29 %
Ash (dry)	42%
C (Carbon)	29.9 % (dry)
S (Sulphur)	0.4 % (dry)
H (Hydrogen)	4.4 % (dry)
O (Oxygen)	18.1 % (dry)
N (Nitrogen)	0.9 % (dry)
Cl (Chloride)	0.6 % (max. 1 %) (dry)
F (Fluoride)	0.1 % (dry)

Project-specific environmental management plan (EMP) is included as part of this EIA to avoid, reduce, mitigate or compensate for adverse environmental impacts/risks. The EMP discusses the following:

- (i) mitigation measures for environmental impacts during construction phase;
- (ii) mitigation measures for environmental impacts during operation phase; and
- (iii) an environmental monitoring program (EMOP), and the responsible entities for mitigating, monitoring, and reporting throughout the project implementation and operation.

The methods to be used for site preparation, construction, operation, and commissioning, as well as associated arrangements to ensure sound environmental management and safety at all times, are already defined in the bid documents. The DBO Contractor shall prepare a Site-specific EMP (SEMP) based on the EMP presented in this EIA in order to make it relevant to the construction and operation phases. The Contractor shall prepare the SEMP by describing specific design features that will ensure environmental protection and setting out the working methods,

management, and mitigation and monitoring measures that will be put in place, for each of the various construction activities, during the implementation of the project. The scope of the SEMP shall address all of the issues itemized in the EMP in this EIA report. The SEMP shall have the same level or stricter set of measures than those included in the EMP of this EIA report.

In the event that DBO Contractor will change the design, technology, layout, components, height and number of stacks, APC system, and sites for the sea water intake and outfall, this EIA together with the EMP and EMOP will require updating. The DBO Contractor shall submit the updated EIA report to PMU, and the PMU shall submit the updated EIA report to ADB for final review and disclosure.

## **J. Information Disclosure, Consultation and Participation**

The project has undertaken numerous stakeholder consultations during the project preparatory stage from 2017 up to 2019. The objectives of the consultations are to ensure that project information is accurately and properly disseminated to all stakeholders and engage them in the environmental assessment process, ensure all issues from the stakeholders about the project are considered in the environmental management planning and ultimately addressed in the EMP. Stakeholder consultations also provide valuable guidance and direction to safeguard the interests of the stakeholders, developers and the environment. Stakeholder engagement will be a continuing activity of the PMU throughout project implementation.

The stakeholders were grouped into internal, external and others including private and civil society. The internal stakeholders comprise the project proponent, MOE, PMU and the Maldives EPA. The external stakeholders include other government regulators and service providers. Other stakeholders include NGOs and the civil society. Interviews with relevant persons from these groups were undertaken. During interviews, discussions focused on the perceptions on the project, the selected locations, environmental or social impacts when implementing the project, energy use and efficiency, harbor and road use, and other aspects. The consultations explored on issues with locations, concerns and suggestions for improving project implementation. Documentation of all stakeholder consultations is included in the EIA report.

## **K. Grievance Redress Mechanism**

The project will adopt the grievance redress mechanism (GRM) established in GMEIWMP. The project GRM will not supersede any legal government grievance procedures. The existing GRM includes three tiers. Every effort shall be given to find an amicable solution before higher tiers could be engaged. Stakeholders and communities are to be informed about the GRM through media and public outlets. An information board providing the contact details will be made available at the project site at Thilafushi, and a register of grievances will be maintained by the DBO contractor and at the PMU.

## **L. Implementation Arrangement**

GMWEP will follow the safeguards implementation arrangement of ADB supported GMEIWMP. A PMU has been established in the MOE and comprising officials including an Environmental Safeguard Officer who is a permanent employee of MOE. The PMU will ensure that the EMP, including the EMOP, is implemented effectively. The PMU will be strengthened with external experts and supported by PMSC. PMU will obtain all necessary statutory clearances prior to award to award contract.

The DBO Contractor is required to designate a full time appoint a Health & Safety Manager (the “H&S Manager”) who will: (i) update this EIA per final detailed design; (ii) establish environmental performance criteria and indicators per final detailed design; (iii) establish pre-work environmental conditions; (iv) implement EMP pre-, during and post-construction, and during O&M; (v) conduct safeguards induction ensuring all personnel and workers are familiar with EMP and relevant health and safety requirements for their work; (v) consult stakeholders and disseminate information related to the project; (vi) address grievances at the site level; (vii) ensure the O&M manuals include requirements as specified in the EMP for operation phase, (viii) report to PMU on a monthly basis, except if there are unanticipated impacts or emergency situations that may cause adverse impact to the environment and surrounding industries; and (ix) implement corrective action plan/s, if required.

## **M. Monitoring and Reporting**

EMP compliance monitoring will be undertaken by the PMU. DBO Contractors will submit monthly reports to PMU. As will be set out in a Project Administration Manual for the project, PMU will prepare and submit reports to ADB on a quarterly basis during construction phase. The submission of semi-annual environmental monitoring reports to ADB during operation phase will continue until ADB issues a project completion report for the project.

Similarly, the PMU will be responsible for the preparation of required environmental monitoring reports and submission to Maldives EPA. Maldives EPA will field annual environmental review missions which will review in detail the environmental aspects of the project. Any major accidents having serious environmental consequences will be reported immediately.

In compliance with ADB SPS, an external environmental expert consultant will be retained under the project who will conduct independent monitoring and review of EMP implementation. The expert will work closely with PMU and DBO Contractor, but will report directly to ADB or occasionally through the PMU.

Additional compliance reports to the MOE required as part of environmental clearance process shall be prepared and based on the required monitoring and reporting format.

## **N. Conclusion and Recommendations**

The EIA of GMWEP has been prepared based on review of technical specifications of the project as included in the DBO bid documents, primary and secondary information of the site and its surroundings. The overall findings of this EIA are:

- (i) The project will result in significant environmental benefits because the current condition in Thilafushi and the project area will be improved;
- (ii) during construction, the project will not have significant adverse environmental impacts and potential adverse impacts are manageable through the effective implementation of the EMP;
- (iii) During operations, the project will have potential impacts on ambient air quality, marine water quality, marine ecology, noise, and occupational and community health and safety. However, with the performance guarantees built in the DBO contract, significant impacts can be avoided, and residual impacts can be mitigated by measures specified in the EMP; and
- (iv) No social impacts pertaining to land loss, land fragmentation, physical displacement, loss of income, loss of productive land, potential income loss for fishermen and preventing fishing-related activities and fishing routes.

In view of the results of the studies undertaken in this EIA, following are the major recommendations that DBO Contractor shall undertake:

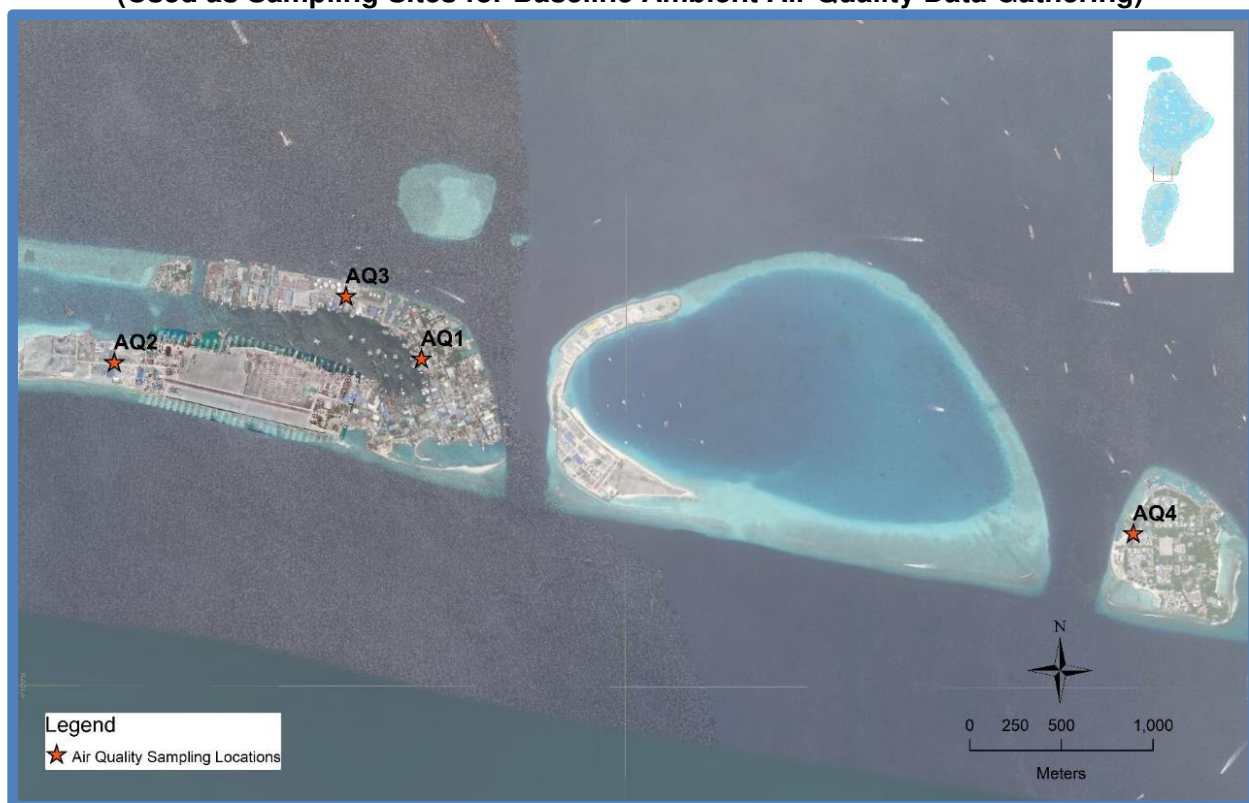
- (i) Engage external expert(s) for verification of environmental monitoring reports and EMP implementation. External expert(s) are not involved in day-to-day project implementation or supervision.
- (ii) Establish the ambient air quality monitoring stations in Thilafushi and Villingili as identified in the AUSTAL2000 and AERMOD air dispersion modeling studies, and utilize these stations for monitoring activities during the operation phase as indicated in the environmental monitoring plan. The proposed locations are in figures below;
- (iii) Conduct validation modeling during the starting months of normal operation of the WTE plant using actual CEMS and stack testing results to simulate actual operation of the plant;
- (iv) Install the cooling water discharge line at section M8 (as identified in the EIA report) and position the outfall of the discharge line at a distance of 70 meters from the shoreline and 30 meters deep from the sea surface;
- (v) Install the intake of the cooling water line at the vicinity of M1-M8 (as identified in the EIA report). Ensure that position of the inlet opening is at minimum distance of 15 meters from the outfall and away from the direction of the cooling water jet plume; and
- (vi) Continuous monitoring around Thilfushi island to confirm the extent of biodiversity in various seasons of the year, including assessment of features pertinent to critical habitats. This is to ensure pre-construction works conditions and biodiversity risks are considered in the design, construction and operation, and to examine and mitigate the potential impacts of the project on areas significant for biodiversity.

Mitigation measures during operation phase are described in the EMP of the EIA report. Apart from all the mitigation measures in the EMP, the following are further recommendations that DBO Contractor shall consider, whichever are practical and applicable:

- (i) A system with controlled burning and a good air pollution control system should be included in the WTE plant design;
- (ii) Incinerator with a stack height of minimum 45.7 m (per air dispersion modeling calculations) to reduce the impacts of air pollutants on the surrounding environment. Increasing this height further will be more favorable;
- (iii) Environmental and occupational health and safety procedures for all processes should be established and enforced;
- (iv) There should be strict inspection and testing during the installation of the HDPE membrane and the various protective / drainage layers for the landfill;
- (v) Preventive measures should be implemented to avoid loss of waste during transport and loading / off-loading;
- (vi) There should be appropriate sanitation facilities and workshops (for machinery), as well as secure storage facilities for fuel and chemicals, including toxic and hazardous wastes;
- (vii) Boilers should be regularly maintained, while structures such as the stacks and ducts should be regularly checked to avoid fugitive dusts sources and particulate accumulation;
- (viii) Control devices such as the Dry Scrubber and Baghouse should undergo regular checkup and maintenance;

- (ix) Solid wastes should have acceptance criteria in terms of waste characteristics;
- (x) Periodic watering of roads to minimize generation and resuspension of dust particles;
- (xi) Greenery and plantation at the perimeter-buffer areas to serve as vegetation walls that can help control dispersion of air pollutants. All plant species to be introduced shall be a known species that thrive in Thilafushi or Maldives. If necessary, the DBO Contractor shall obtain permission from relevant agency of the government to ensure such plant is endemic or native species in Maldives
- (xii) Ensure to follow the government policy on preventing introduction of invasive alien species in the island. In particular, DBO Contractor shall use as reference the guidance issued by the MOE attached as Appendix 21 in the EIA report;
- (xiii) Regular ambient air quality monitoring should be conducted in hot spots and impacts areas based on the results of the modeling report. Actual ambient monitoring may be treated as validation of model results; and
- (xiv) Every modification and installation of new sources should be considered as additional contribution to emission of the plant. Hence, modeling updates should also be conducted to determine assimilative carrying capacity of the area based on the impacts of the new modification or installation.

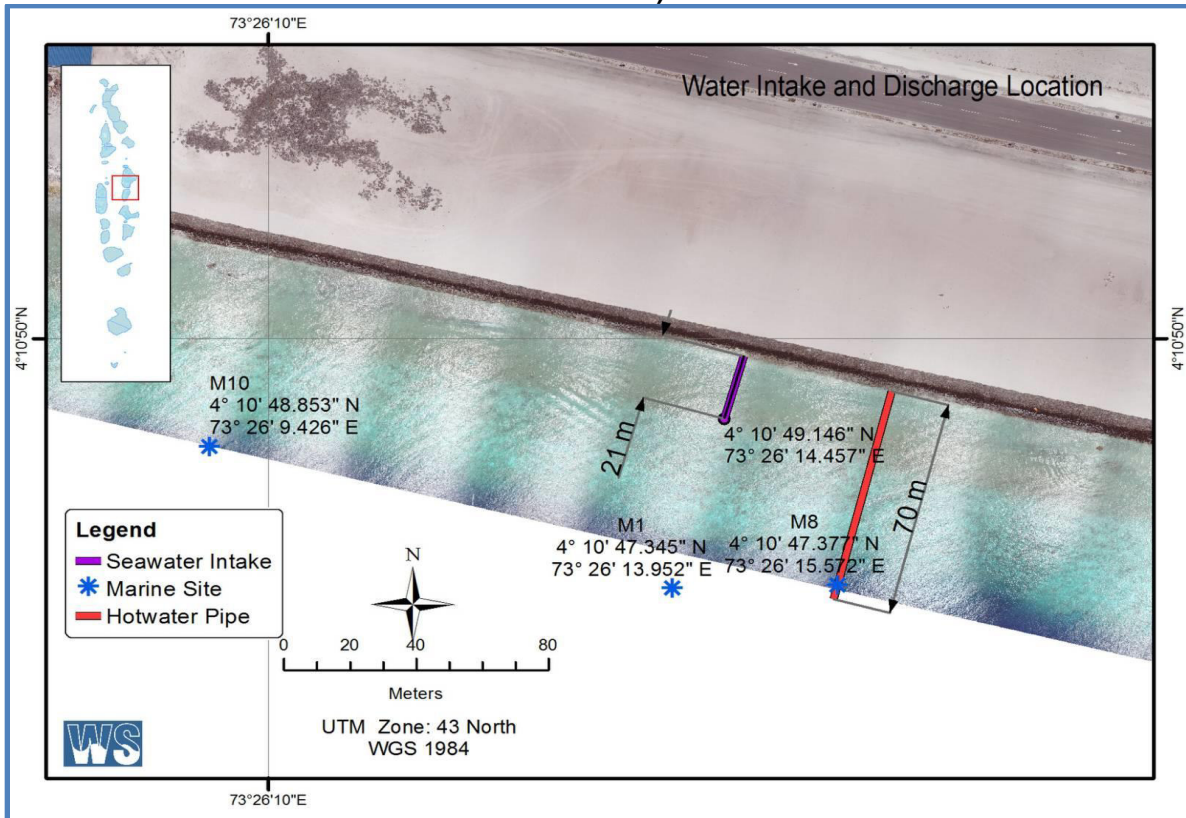
**Figure 2: Recommended Ambient Air Quality Monitoring Sites (AUSTAL2000)  
(Used as Sampling Sites for Baseline Ambient Air Quality Data Gathering)**



**Figure 3: Recommended Ambient Air Quality Monitoring Sites at Thilafushi (AERMOD's confirmation of recommended sites by AUSTAL2000, plus additional recommended sites at ASR2, ASR3 and ASR5 locations)**



**Figure 4: Recommended Inlet and Outfall Location for Cooling Water (M1 and M8 Sections)**



## I. INTRODUCTION

### A. Background

1. The Greater Malé capital region and its outer islands (project area) suffer from severe environmental pollution and deteriorating livability because of inadequate collection and haphazard disposal of solid waste. The project area covers 35 inhabited islands within the following atolls (island chains): the North Ari Atoll (Alifu Alifu Atoll), South Ari Atoll (Alifu Dhaalu Atoll), Vaavu Atoll and Malé' Atoll (Kaafu Atoll), which includes the capital city of Malé. The total population within the project area is approximately 295,000 (53% of Maldives total population).<sup>18</sup> Lack of a sustainable system to manage the 836 tons per day (tpd) of solid waste generated in the project area (2019) results in waste spillage into the ocean, and open dumping and burning of garbage at the 30-year old 10-hectare dumpsite on Thilafushi Island which has no pollution control measures creating a public health and an environmental hazard.<sup>19</sup> Plumes of smoke visible from the capital Malé, the international airport and nearby resorts compromise air quality and pose nuisance to residents and tourists, while leachate and plastics contaminate the surrounding marine environment. This poses a critical threat to tourism and fisheries, both of which rely heavily on the country's pristine environment and are cornerstones to Maldives' economy.<sup>20</sup>

2. Support to the government's efforts to strengthen solid waste management (SWM) services in the project area included financing under the GMEIWMP, approved in 2018, to improve the upstream segment of the SWM chain including collection, containerized transfer, and institutional capacity and public awareness for sustainable SWM service delivery.<sup>21</sup> The ongoing project is also assisting the government in treating and recovering construction and demolition waste and implementing temporary measures, such as bailing of municipal solid waste, as adequate interim solution to stop open dumping and burning on Thilafushi until a modern solid waste treatment and disposal facility will be operational. The project is under implementation and expected to be completed by 2023.

3. The project is aligned with the following impact: promote waste as a valuable resource for income generation (footnote 8). The outcome will be disaster- and climate- resilient solid waste treatment and disposal services improved in the Greater Malé region and its outer islands. The project will have two outputs.

4. **Output 1: Disaster- and climate-resilient regional waste management facility developed.** This will include (i) a 500 tpd WTE plant with 20-year O&M contract, including two treatment lines of 250 tpd each, energy recovery of 8 megawatt capacity (surplus electricity) and

---

<sup>18</sup> Government of Maldives, National Bureau of Statistics – Ministry of Finance and United Nations Population Fund. 2018. *Maldives Population Projections 2014-2054*. Malé.

<sup>19</sup> Breakdown of solid waste by type: construction and demolition = 530 tpd (68%), household = 149 tpd (19%), resort = 48 tpd (6%), commercial = 27 tpd (3%), airport = 9.3 tpd (1.2%), industrial = 6 tpd (0.8%), market = 2.5 tpd (0.3%), hazardous = 1.5 (0.2%), and end-of-life vehicles = 0.65 tpd (0.1%). Source: Government of Maldives, Ministry of Environment and Energy. 2018. Feasibility Study for an Integrated Solid Waste Management System for Zone III (including Greater Malé) and Preparation of Engineering Design of the Regional Waste Management Facility at Thilafushi. Malé

<sup>20</sup> A quarter of country's employment is in tourism and fisheries. Tourism account to 30% of gross domestic product and expected to expand in the area. Government of Maldives, National Bureau of Statistics – Ministry of Finance. 2015 Maldives Population & Housing Census 2014 – Statistical Release 4: Employment. Malé.

<sup>21</sup> ADB. 2018. Report and Recommendation of the President to the Board of Directors: Proposed Grant and Technical Assistance Grant and Administration of Grant to the Republic of Maldives for the Greater Malé Environmental Improvement and Waste Management Project. Manila. (Grant: 0580-MLD and 9195-MLD and TA: 9543-MLD)

air pollution control (APC) system; and (ii) a landfill for safe disposal of APC residues and non-marketable bottom ashes. The facility will be able to accommodate a third 250 tpd treatment line, required to respond to further demand increase. The WTE technology minimizes land requirements and produces renewable energy addressing the critical land and electricity constraints in the Maldives. Recycling of marketable incineration bottom ash and metals will be promoted to further reduce landfill requirements and provide valuable materials for the construction industry. The WTE will be implemented through a DBO contract with long term O&M period to ensure sustainable operations. All facilities will adopt disaster- and climate-resilient features such as raised floor elevations, flood proof mechanical and electrical equipment and landfill cells, and enhanced drainage systems.

**5. Output 2: Institutional capacity in sustainable SWM services delivery (WTE) and environmental monitoring strengthened, and public awareness on WTE and 3R improved.**

This will include (i) capacity assessment of MOE and EPA for monitoring and ensuring sustainable WTE operations and support implementation of institutional improvement plan; (ii) strengthening MOE and EPA staff capacity in monitoring WTE operational performance and environmental standards, and managing performance-based DBO contract; (iii) support to enhance financial sustainability for WTE O&M, through implementation of an agreed O&M financing plan, including financial need forecasting and finalization of financing sources, revenue enhancement plan, responsibilities, and fund flow arrangements for payment of O&M; and (iv) public awareness campaigns on WTE and 3R benefits. The project will support PMU and government capacity to prepare, monitor, and manage sustainable WTE through consulting services for contract management, monitoring, supervision, and institutional development.

6. The project develops a modern regional waste management facility to treat current and future solid waste generated in the project area responding to a critical SWM service delivery gap. The WTE technology minimizes land requirements and produces renewable energy addressing the critical land and electricity constraints in the Maldives. Marketable incineration bottom ash recycling will also be promoted to further reduce landfill requirements and provide valuable inerts for the construction industry. In line with lessons learnt from previous experience, the project (i) will employ 20-years O&M period in the WTE contract to ensure sustainable operations; (ii) has high readiness with 90% of total project amount under procurement;<sup>22</sup> (iii) will strengthen PMU and government capacity to monitor SWM service delivery through consulting services for contract management, monitoring, supervision, and institutional development; and (iv) will raise public understanding on WTE and sustainable 3R through awareness campaigns.

7. The project is estimated cost is \$151.13 million, including contingencies and financing charges. The government has requested (i) a grant not exceeding \$35.18 million from ADB's Special Funds resources (Asian Development Fund [ADF]); and (ii) a concessional loan of \$38.21 million from ADB's ordinary capital resources to help finance the project. The loan will have a 32-year term, including a grace period of 8 years; an interest rate of 1.0% per year during the grace period and 1.5% per year thereafter; and such other terms and conditions set forth in the draft loan and grant agreement. The government has also requested a loan not exceeding \$40.00 million from the Asian Infrastructure Investment Bank (AIIB) to help finance the project. The AIIB loan will be partially administered by ADB. The AIIB loan's terms and conditions will be described

---

<sup>22</sup> The project is part of a phased approach consisting of two projects including the Greater Malé Environmental Improvement and Waste Management Project and Greater Malé Waste to Energy Project. This is to match implementation capacity of government and improve project readiness for efficient resource allocation. This allowed for urgent measures to be implemented while complex WTE infrastructure prerequisite measures being prepared, including reclamation of 15 hectares of land and procurement process.



in a loan agreement between AIIB and the government. The Japan Fund for Joint Crediting Mechanism will provide grant cofinancing equivalent to \$10 million, to be administered by ADB.

## **B. Purpose and Scope of the EIA**

8. This EIA focuses exclusively on the WTE plant (including its ancillary facilities) as most environmentally sensitive component of GMWEP given its construction and operation is likely to have significant adverse environmental impacts that are irreversible, diverse, or unprecedented. These impacts may affect an area larger than the sites or facilities subject to physical works. Thus, GMWEP is classified as Category A for environment per ADB Safeguard Policy Statement (SPS) and an environmental impact assessment (EIA) is required. Accomplished ADB Rapid Environmental Assessment Checklist is in Appendix 1.

9. The purpose of the EIA is to meet ADB SPS requirement for Category A projects and to comply with Government of Maldives requirements under EIA Regulations of 2012. This EIA report has been prepared in accordance with the requirements of ADB SPS and the terms of reference (TOR) dated 24 September 2018 issued by the Maldives Environmental Protection Agency (Maldives EPA). Matrix of compliance on the requirements of the TOR is attached as Appendix 2.

10. This EIA report will be submitted to ADB and Maldives EPA as a requirement for ADB financing and compliance with the Environmental Protection and Preservation Act (EPPA or Law 4/93) of Maldives, respectively. Clause 5 of the Law 4/93 states that a report should be submitted before implementation of any project that may have a potential impact on the environment. A gaps analysis between ADB SPS and EPPA is attached as Appendix 3.<sup>23</sup> The gaps analysis describes various recommended gap-filling measures in order to ensure EPPA is fully aligned with ADB SPS. All gap-filling measures applicable to the WTE project have been considered in undertaking this EIA.

11. The scope of this EIA covers the following: (i) description of the WTE plant and ancillary facilities (the project); (ii) identification and description of the elements of the environment and community/stakeholders likely to be affected by the project and/or likely to cause adverse impacts to the project, including both the natural and man-made environment; (iii) information on the consideration of alternatives/options for design, site locations and layouts of the project to avoid and minimize potential environmental impacts to environmentally sensitive areas, other sensitive uses and sensitive receptors, including reasons for selecting the preferred option(s); (iv) description of environmental factors played in the selection of the preferred option(s); (v) identification and assessment of impacts on marine environment, groundwater, avifauna, biodiversity, air quality, water quality, waste management implication, land-based and marine traffic, socio-cultural and livelihood, occupational health and safety, landscape and visual, and determination of significance of impacts on sensitive receivers and potential affected uses; (vi) mitigation measures so as to minimize pollution, environmental disturbance and nuisance during construction and operation of the project; (vii) identification, prediction and evaluation of residual (i.e. after practicable mitigation) environmental impacts and the cumulative effects expected to arise during the construction and operation phases of the project in relation to the sensitive receivers and potential affected uses; (viii) identification, assessment and specification of methods, measures and standards, to be included in the detailed design, construction and operation of the project which are necessary to mitigate these environmental impacts and reducing them to acceptable levels; (ix) identification of constraints associated with the mitigation

---

<sup>23</sup> Comparative Analysis of Maldives Framework and ADB Safeguard Policy Statement. ADB TA 7566. 2015.

measures recommended in the EIA study and, where necessary, to identify the outstanding issues that need to be addressed in any further detailed EIA study; and (x) design and specifications in the environmental monitoring and audit requirements to ensure the effective implementation of the recommended environmental protection and pollution control measures.

12. The impact assessment includes (i) collection and use of field data gathered during the period from January 2018 to November 2019, (ii) consultations with stakeholders, and (iii) professional judgment and experience of the EIA team members. In addition, satellite and aerial photos have been used to study the geography and environmental changes at the project site. Moreover, similar project reports have been reviewed and referenced in completing this report. Below are the reports that have been reviewed.

- (i) Feasibility Study for an Integrated Solid Waste Management System for Project area (including Greater Malé) and Design of the Regional Waste Management Facility at Thilafushi, Ministry of Environment, Malé (MOE, 2018);
- (ii) EIA for the Proposed Reclamation of Thilafalhu for the establishment of the Regional Waste Management Facility for Project area, Kaafu Atoll, Maldives (MEE, 2017);
- (iii) EMP for the establishment of Island Waste Management Center in L. Hithadhoo, (MEE, 2017);
- (iv) EIA for the Permanent Sand Borrow Site for Repairing and Leveling of Roads at K. Thilafushi (MEECO, 2015);
- (v) Environment & Social Assessment & Management Framework Climate Change Adaptation Project (MEE, 2014);
- (vi) Environmental and Social Impact Assessment for North Regional Waste Management Facility Construction and Operation (MEE, 2012);
- (vii) EIA for the proposed solid waste management facility at Thilafushi, Kaafu Atoll Maldives, (CDE, 2011);
- (viii) ESIA for Construction and Operation North Regional Waste Management Facility at R. Vandhoo (MEE, 2012); and
- (ix) Engineering Investigation and Environmental Studies for Integrated Waste Management Facilities or managing municipal solid waste (MSW) Hong Kong (AECOM, 2011).

### **C. Stage of the project preparation**

13. The project is a Design-Build-Operate (DBO) type of project, therefore, a detailed design is to be prepared by the contractor (DBO Contractor) who will win the project. The procurement and bidding documents have been prepared and are under review by ADB and the government of Maldives. A pre-qualification stage has already been launched and evaluation of bids is underway.

### **D. EIA Preparation and Implementation**

14. The EIA has been conducted by the Project Management Unit (PMU) through its consultant, Water Solutions, a duly registered consulting firm in Maldives which specializes in undertaking impact assessment of various projects in the country. Water Solutions, in turn, engaged with various international consulting firm partners to undertake several studies and modeling necessary for the assessment of impacts of the projects. Water Solutions engaged Ulbricht Consulting of Germany to do the air dispersion modeling using AUSTAL2000, including stack height calculations for the WTE plant. As confirmatory measure, the air dispersion modeling

was re-run using the AERMOD model. Water Solutions also engaged Lanka Hydraulic Institute of Sri Lanka to do the heat dispersion modeling for the cooling water generated by the WTE plant during operation phase.

15. Initial biodiversity screening for a defined area of analysis encompassing the project location was undertaken. Results show the area of analysis is likely a critical habitat. Results also show the existence of marine protected areas (MPAs) and species included in the IUCN Red List. In view of this, Water Solutions undertook a critical habitat assessment from October to November 2019 and included as part of the EIA.

## **E. Methodology**

16. **General Approach.** This EIA report has been guided by ADB SPS and Maldives EIA Regulations 2012 to ensure that the significant environmental impacts of the proposed project have been considered and assessed at the project planning phase. Accordingly, the EIA process and report preparation follow the outline provided in ADB SPS.

17. **Environmental Scoping.** With the understanding of the nature and location of the project, the environmental scoping was done to narrow down the most critical issues for such kinds of project, which will require more careful and in-depth analysis during the assessment. The most critical aspects identified that need attention are the impact of air emission to surrounding receptors and the impact of any form of discharge to the marine environment in the area. All environmental issues were categorized into physical, ecological and socio-economic aspects.

18. **Desk Research.** Based on the outline of the EIA process, several information needs may already be available from various sources. Desk review and research online have been done to obtain all this information that will aid in the assessment. This included documentary review on the nature of the proposed activities to be employed, background documents and published documents related to previous projects, procurement plans, draft bidding documents, policy and legislative framework of the government that will govern the implementation of the project, the environmental setting at the project site, and all other information. It also included discussions with project managers, government proponents, international procurement and contract experts engaged under the project, and other consultants.

19. The laws and regulations were reviewed such as the Environmental Protection and Preservation Act (4/93), Environmental Impact Assessment Regulation 2012, Environmental Liability Regulation, Waste Management Regulation, Land Act, Land Use Planning Regulation, General Laws Act, Coral and Sand Mining Regulation, Building Act (404/2017), Maldives Building Code, Dewatering Regulation (2013/R-1697), Maldives Energy Policy and Strategy, Desalination Regulation, General Guidelines for Domestic Wastewater Disposal, Maldives Intended Nationally Determined Contribution, Second National Communication of Maldives to UNFCCC, and Employment Act (02/2008).

20. **Baseline Data Gathering.** Conditions of the existing environment were analyzed by using appropriate scientific methods. The leading environmental components of the study area were divided into physical environment, biological/ecological environment and socio-economic condition. The physical environment is further divided into terrestrial, and coastal and marine environments. The marine environment of the island covered the lagoon and house reef south of the proposed project area. The coastal environment covered the coastline within the project boundary.

21. **Information Disclosure and Consultation.** In order to conduct a broad based and inclusive EIA, the proponent and the consultant have taken a participatory approach. The project details have been shared with stakeholders, and all issues and concerns from these stakeholders have been assessed and integrated as part of the EIA.

22. **Environmental Management Plan (EMP).** The EMP has been formulated based on the project circumstances during the different phases of implementation. It provides all actions, mitigation measures, institutional arrangements, and reporting, among others, to ensure that the project will not cause significant impact to the environment and the people around the project site.

## II. DESCRIPTION OF THE PROJECT

23. **Need and Justification.** Solid waste management is one of the main environmental issues in the Maldives. Rudimentary practices in solid waste management have resulted in vastly degrading marine and terrestrial environments throughout the country. A significant portion of this problem is due to the geographical scatter of islands and the scarcity of land on these islands. An accelerated population growth over a short period of time over the last several decades has ensured the growth of the solid waste problem with it, while the management of this solid waste has not been receiving the attention it should require. Thus, solid waste has been managed in the country in the form of dumpsites and open-air burning.

24. The island of Thilafushi in Kaafu Atoll has been utilized over the past few decades to serve as the dumpsite for solid waste generated from Malé, its biggest source, and other nearby inhabited islands and resorts. Large quantities of waste generated in Malé are taken to stockpile at the disposal site on the island of Thilafushi. The stockpile at the site is continuously burned sending massive plumes of dark smoke into the atmosphere, before open dumping in a bunded lagoon. Thilafushi also receives wastes from tourist resorts. Overall, there are significant potential impacts of solid waste on the environment and public health, and on the potential sustainability of tourism in the Maldives. However, the lack of a long-term strategy for solid waste management in Thilafushi has resulted in numerous environmental detriments, from immense visual pollution to locals and tourists alike, to significant marine pollution and an even greater problem, that of air pollution. Due to the lack of control over the dumping in Thilafushi, various flammable, reactive and hazardous substances have been dumped over time. As a result, surface fires occur on site on a daily basis, releasing a plume of smoke into the air that spreads to nearby islands, and as far as to Malé and Hulhumale'. The waste disposal site at Thilafushi is non-engineered low lying and by far the largest solid waste disposal site in the Maldives. The site has minimal environmental protection measures.

25. The issue of solid waste management in the Maldives is of critical importance, and the Ministry of Environment (MOE) seeks to address the issue. A key area is the Greater Malé region and nearby atolls, which together encompass a significant portion of the country's population. Therefore, the MOE has proposed a Regional Waste Management Facility for Project area of the Maldives, including Kaafu Atoll, North Ari Atoll, South Ari Atoll, and Vaavu Atoll. This facility will consist of the proposed Waste-to-Energy (WTE) plant project that is subject of this EIA. The WTE plant has been selected as the viable option to reduce the volume of solid wastes to a level of residual waste that can be disposed and managed given the limited land area in Project area.

26. There are a number of benefits with the implementation of the WTE plant, including:

- (i) Substantial bulk reduction for landfill disposal - The amount of MSW to be disposed of at landfills will substantially decrease as the volume of waste remaining after the thermal treatment process would only be about 10% of the original volume. Hence,

the residual waste landfills and their extensions can serve for a longer period of time.

- (ii) Energy recovery - The WTE plant could generate and export electricity for gainful uses by the industries at Thilafushi.
- (iii) Greenhouse gas reduction - The production of greenhouse gases due to landfilling of MSW will be reduced. The WTE plant will generate electricity for the industries on Thilafushi, replacing their dependence on fossil fuel-based power generation, leading to an overall reduction of greenhouse gas emission by the Maldives.

27. The project has been considered as strategical and vital by the Government of the Maldives for the improvement of the environment in the country and consequently for a better living condition of the surrounding population in the greater Malé region, and to improve the attractivity of the Maldives as an ecological friendly tourist destination.

28. **Location.** The project will be located in Thilafushi, an island that has been reclaimed since December 1992 by dumping of wastes on the submerged "Thilafalhu" lagoon area. Thilafushi is located on the southern rim of North Malé atoll, and on the eastern line of atolls within the archipelago. Thilafushi is located in North Malé atoll, 9.5km from Malé. In terms of geographic coordinates, it is located at 04° 11' 00" N and 73° 26' 44" E. The nearest inhabited island is Villingili, approximately 7.1 km east of Thilafushi. The island was initially developed as a sand bank using dredged material from the Thilafushi Reef. Since then, land has been reclaimed by placing solid waste in dredged holes on the reef flat and later topping it up with fresh lagoon sand. This project will be located on a 27 hectares government-owned land, of which 15 hectares have been reclaimed from shallow lagoon. The old dumpsite will be closed and remediated when the RWMF becomes operational. Figure 1 illustrates the location of the project.

29. According to the Thilafushi Industrial Master Zoning 2014 an area of 27.8 ha. has been allocated for the project, the breakdown of which is as follows:

- (i) Existing Thilafushi Dumpsite : 10.1 ha
- (ii) GMEIWMP Infrastructures: 2.45 ha
- (iii) GMWTE Infrastructures:14.25 ha

30. The reclamation works was undertaken by the government in anticipation of the WTE plant, which was also subjected to an EIA process as part of the requirements of the Government of Maldives EIA Regulations of 2012. Reclamation works involved mainly filling and levelling activities. The land was reclaimed to a height of +1.5 m from mean sea level (MSL) from an average depth of -1.5 m above the sea floor. During preparation of this EIA, about 5% of the reclamation work is still being carried out to complete coastal protection structures around the newly reclaimed land. The finished ground level of the site will be at a level higher than the average ground level of the Thilafushi.

31. As the reclamation works is in anticipation of ADB project, an environmental audit has been undertaken on the reclamation project to determine whether the actions and activities were in accordance with ADB safeguard principles and requirements, and to identify and plan for appropriate measures to address outstanding compliance issues. The reclamation project has long been almost accomplished prior to this environmental audit. No actual dredging activities was observed as part of the audit. However, based on all documents and records reviewed, statutory requirements were complied with and that the necessary environmental impact assessment was undertaken and approved by the government. There is an indication that the environmental performance of the reclamation project was satisfactory, and that the development

activities did not cause any significant adverse impacts to the environment. The EIA report for the land reclamation, field confirmation and discussion with PMU, stakeholders and Environmental Protection Agency confirmed siltation on the reef is present prior to the land reclamation activity for the project and can be attributed that the island itself is being reclaimed for the past 2 decades. The environmental audit is included in the EIA report and concluded (i) land reclamation has no adverse impacts on the environment, coastal ecosystem, and people in Thilafushi, (ii) all mitigation measures have satisfactorily complied by the contractor; (iii) the project proponent submitted required reports to Maldives Environmental Protection Agency; and (iv) no compliance issue. The land reclamation is small-scale (15 hectares) to affect motion of water and suspended sediments in the area around Thilafushi and adjacent island. The water sampling conducted post-land reclamation (for preparation of the EIA report) also confirmed land reclamation has not caused significant changes the quality of the surrounding areas of water. Summary of the findings of environmental audit is in Appendix 4.

32. Figure 2 shows the 3D impression of the entire RWMF at Thilafushi Island indicating the locations of the various components under the GWEIWMP and GMWTE, including the WTE Plant.

Figure 1: Project location

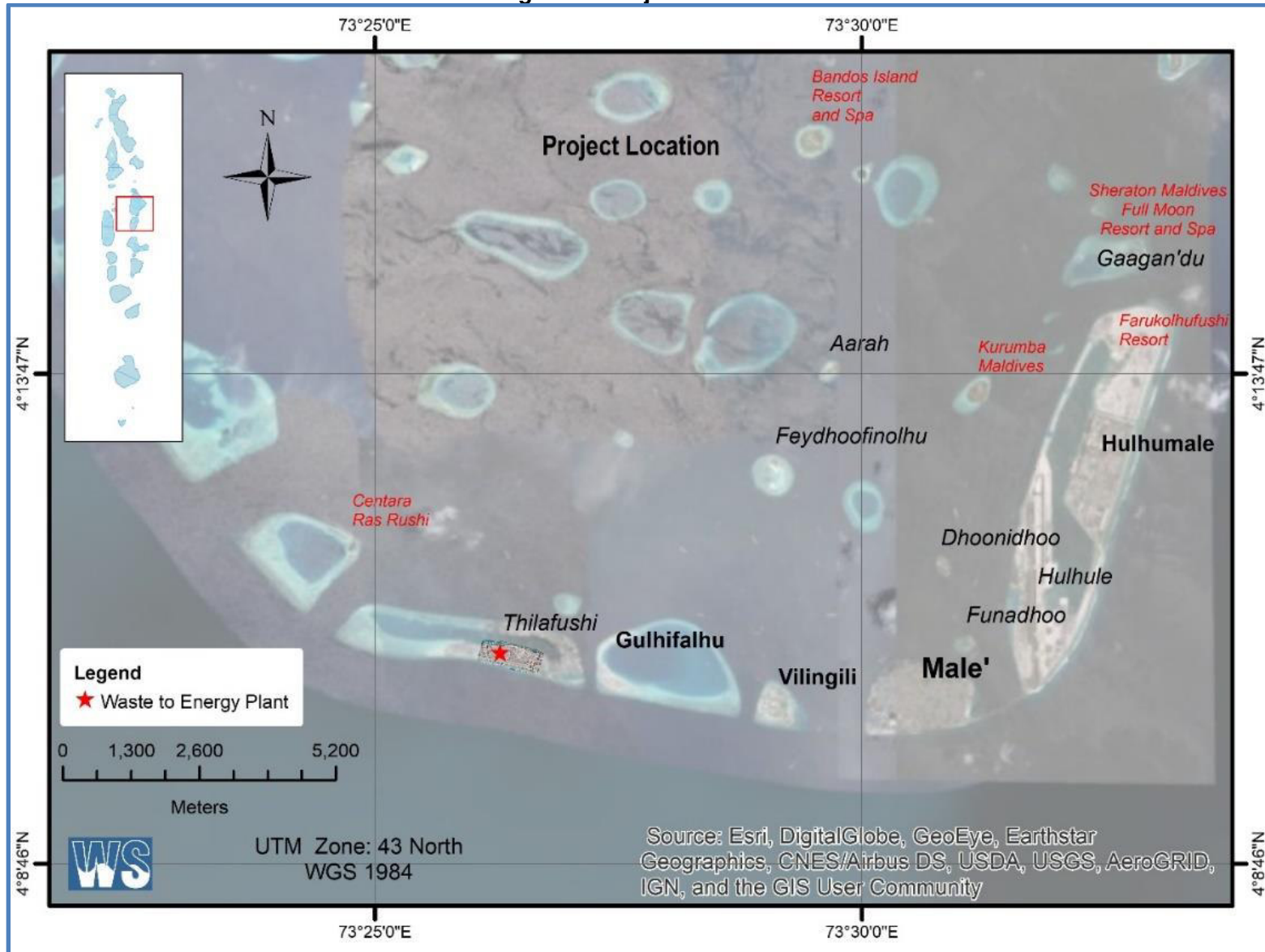


Figure 2: 3D Impression of the proposed RWMF for Project area at Thilafushi





Figure 3: Location of project at Thilafushi Island

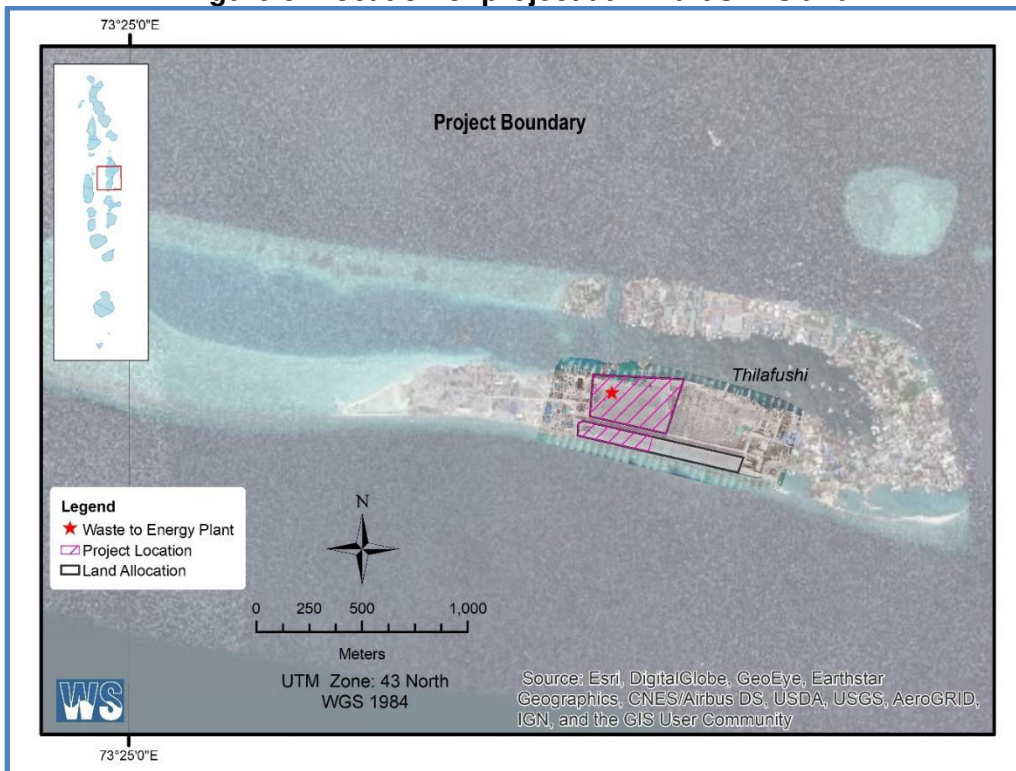
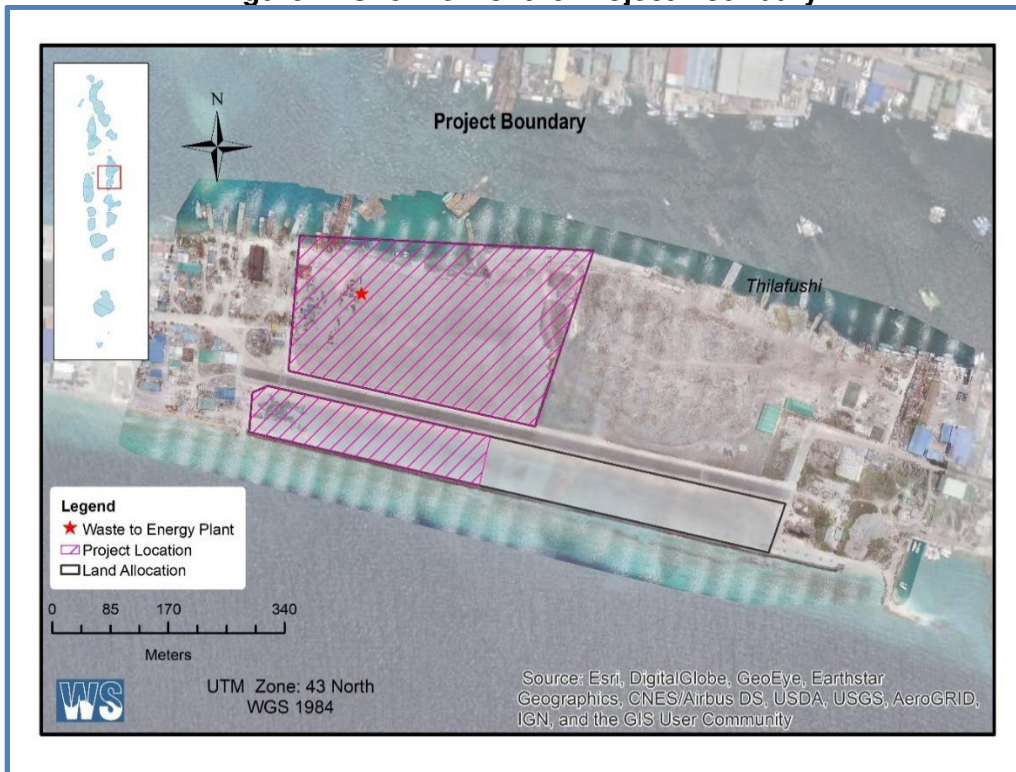


Figure 4: Overview of the Project Boundary



## A. Project Components

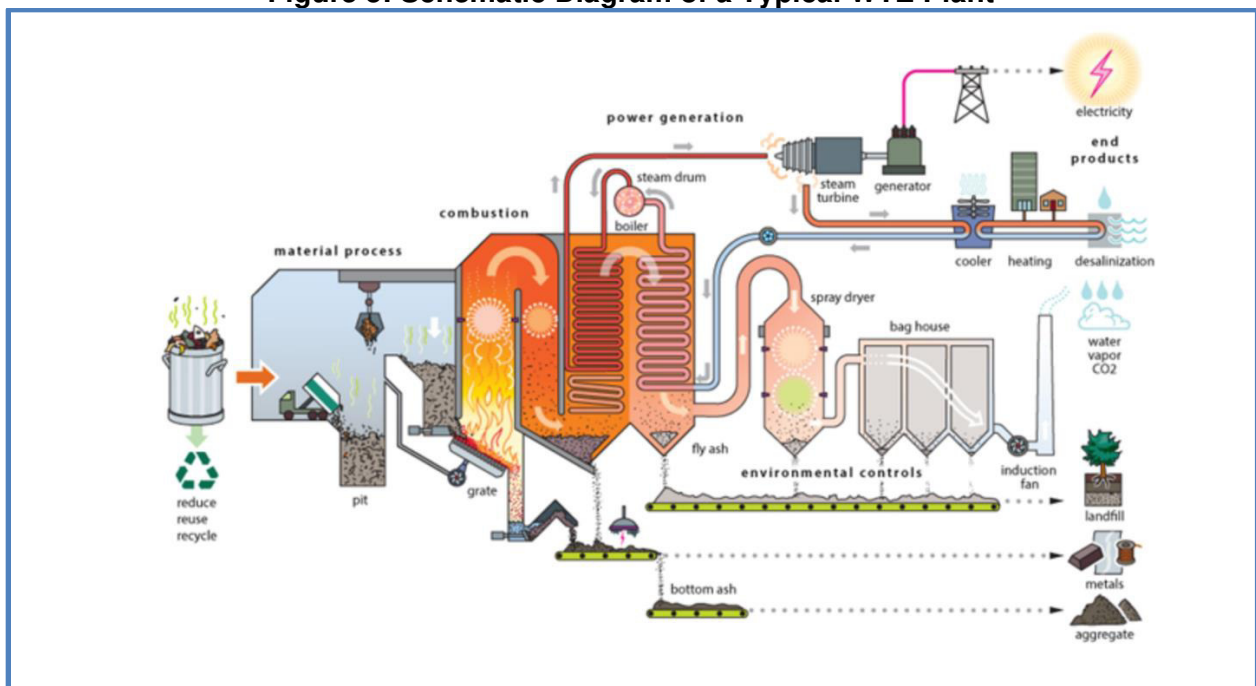
33. This EIA report utilizes components based on preliminary design of the WTE plant provided by the government. This subsection discusses the details of these project components. As the project will be awarded under a DBO type of contract, the DBO Contractor will finalize the detailed design and update this EIA report accordingly. Per preliminary design, the WTE will have 10MW power production with 2 MW to be used for the facility itself (and other parasitic loads). The surplus power of 8 MW will be fed to the main grid through a cable link between Thilafushi island and Malé or Ghule Fahlu. The government is still at planning stage of putting this link through a bridge (also at planning stage) to be constructed in between the islands.

34. The construction of the WTE plant infrastructures will include the following stages:

- (i) Civil and building works;
- (ii) Mechanical & electrical plant installation;
- (iii) Road, utilities, services and landscaping; and
- (iv) Ancillary instrumentation and control works.

35. A schematic diagram of the WTE plant processes based on preliminary design is shown in Figure 5 below.

**Figure 5: Schematic Diagram of a Typical WTE Plant**



Reference: Application to Access JFJCM Resources for Greater Male Waste to Energy Project (Phase 2 of Greater Male Environmental Improvement and Waste Management Project

36. Figure 5 illustrates a single line of the proposed WTE plant and shows the stages of waste treatment and processing in an incineration system, and the processes of how the energy is generated. As initial step, waste is dumped by the waste trucks into the waste bunker (pit) of the incineration plant. The waste is then lifted by a crane and hauled into the hopper, which feeds the combustion chamber of the incinerator. The waste moves slowly down through the grate and burns. The combustion chamber is fed with air from the waste bunker. The residence time of the

waste onto the incineration grates does not exceed 60 minutes. The primary air supply ensures the direct combustion of the waste, while the secondary air seeks to achieve turbulent mixing of the waste in order for the combustion to be complete. In order to accomplish complete combustion of the gases, it is necessary for the gases to be at a temperature above 850 °C for at least 2 seconds. Complete combustion is indicated by the levels of the carbon monoxide in the off gases. Auxiliary firing systems are used to keep the combustion gases at the desirable temperature levels. In the process, the grates need to be cooled through the air coming from underneath because high temperatures can damage the grate. The flue gas generated will pass through the flue gas cleaning system. The cleaned and cooled gases are discharged into a stack. The gases are discharged by means of an induced drafted fan.

37. The utilization of the generated heat (since combustion is an exothermic process) is most commonly made via the generation of high-pressure, superheated steam from the heat exchange between the flue gas (which absorb the majority of the heat produced) and the water/steam circuit, within a boiler. The flue gas treatment system is the biggest part of a waste to energy plant. The flue gas has to be cleaned very carefully before entering the stack.

38. After the combustion process, two types of residual wastes are generated. These are (i) bottom ash from the grate chamber, and (ii) fly ash from the flue gas cleaning. After recovery of these ashes, they are cooled down. The bottom ash passes through a section with electromagnetic field, which separates any metals from the ashes. It then passes through a sieve and finally stored in an ash bunker.

39. The residual wastes from the waste incineration are bottom ash, slag and the residues from flue ash. Bottom ash and slag is a valuable fraction which may potentially be used for many purposes such as covering material for landfill, ballast layer or reinforcement layer in road construction or filler/aggregate for construction blocks. Under any circumstances that these options are not allowed or not safe, the landfill will be able to accommodate the residual wastes. The hazardous residues from the flue gas cleaning (fly ash) will be conditioned safely in sealed bags and disposed in a controlled way at the sanitary landfill. Similarly, the fly ash collected from flue gas cleaning is cooled down, stored in big bags and disposed in the same residual waste landfill. This landfill shall be designed to follow internationally recognized best practices and standards as discussed in this EIA report.

## **1. Waste Reception, Storage and Feeding Facilities**

40. The waste reception, storage and feeding process will have the mechanical equipment for the following process components:

- (i) weighing system;
- (ii) waste reception hall (tipping hall);
- (iii) waste bunker;
- (iv) waste cranes; and
- (v) supply of waste oil.

41. The mechanical equipment shall be complemented by electrical, control and safety components which, jointly with the civil works relating to this process unit, shall be arranged to a fully functional process unit that allows for weighing of incoming and exiting materials, for unloading of waste delivery vehicles, for storage of waste and for feeding of waste to the subsequent process unit. Further to this, the design shall include the necessary odor and fire

control system and any other related safety feature to facilitate a constantly safe operation of the process unit.

42. **Waste reception.** Waste will be delivered by WAMCO predominantly, while commercial and industrial entities having premises on Thilafushi will, upon approval by WAMCO, deliver waste using their vehicles as well. Waste will be delivered mostly via closed containers (up to 25 m<sup>3</sup> volume). In addition, WAMCO will reduce the baled stock and deliver baled and wrapped waste up to a ratio of the mechanical capacity.

43. The design shall include a waste reception hall that shall comply with environmental, health and safety, and operational requirements for all personnel entering the tipping hall, including all necessary electrical and control components to allow for a 24/7 operations. Whenever required due to emergency operations requirements, all shutters shall be controlled according to applicable emergency procedures. The waste reception hall shall be an enclosed area equipped with adjustable louvers that allow ventilation of the hall. Odor emissions shall be prevented by a draft induced by the primary air supply fan. Entry and exit gates shall be closed by an electrically driven fast acting shutter with an airtight design. The dimension of the reception hall shall allow for safe flow of incoming and exiting vehicles. Access to the waste reception hall for all waste delivery vehicles shall be restricted by automatic traffic lights in the event all tipping bays are occupied. The traffic lights shall be positioned to avoid vehicles entering the access ramp when access is denied.

44. Wherever reasonable and applicable, the supporting structures of the building and the access gate shall be equipped with impact protectors while elevated curbs shall be protected with edge angles or embedded steel plates to prevent damages from wheel loader buckets.

45. The design shall also include tipping bays, which shall be closed by electrically or hydraulically driven flap door or roller gate when not in use. The doors or gates shall be made for heavy duty to withstand the likely dust laden atmosphere of the bunker. For all tipping bays, safety curbs shall be provided to prevent reversing vehicles from falling into the bunker. Tipping bays shall be made of wear resistant concrete or shall be covered by wear resistant steel sheets.

46. The waste reception hall and the tipping bays shall be surveyed by tilting CCTV cameras with a central control room. For cleaning purposes, the reception hall shall be provided with a sufficient number of power sockets and water supplies to allow a high-pressure steam cleaner to operate. Water shall be collected by the drainage system. Subject to the design considerations, a waste inspection area shall be provided either inside or outside of the reception hall, which shall enable inspection of suspicious wastes.

The shredder for bulky waste, tree trunks, mattresses (if need be) and other larger objects to be incinerated shall be a slowly rotating machine to prevent any sparking. In any case, the shredder shall be equipped with a spark detection and fire suppression system prior to conveying the shredded material to the bunker. The shredder shall be of a robust design which facilitates high endurance with limited wear and tear. The shredder shall be electrically driven and shall be equipped with a local control.

47. **Weighing facility.** The weighing system shall consist a weigh bridge and weighing software that will be used to:

- (i) weigh incoming wastes;
- (ii) control the supply of fuels and chemicals;
- (iii) weigh any kind of residue which leaves the facility either directly (APC residues)

- or after processing (bottom ash, metals);
- (iv) weigh any other material whose mass shall be controlled; and
- (v) enable a mass balance of the WTE plant.

48. The design of the weigh bridge and its computerized recording of incoming and exiting vehicles shall facilitate the operations without any manual intervention during weight recording. It shall be at the discretion of the DBO contractor to decide whether to install an Automatic Vehicle Recognition System or whether to determine the weights via manually triggered weighing or by scanning bar codes, tokens or the like. Load (or weighing) cells shall be calibrated by a third party or by the supplier certifying the correctness of their functions. The weighing system shall allow for each weighing event to be logged and allocated to a delivery vehicle jointly with a time stamp for entering and exiting. Weighing records shall be archived without any option to modify or manipulate data, unless there is a valid reason to do so. The weighing software shall enable the exchange of data with the Plant Management Information System (PIMS). All components of the weighing system which are prone to corrosion shall be manufactured using corrosion protected steel. The entire system shall not be affected by electromagnetic fields, e.g. radio frequencies, industrial frequencies. Appropriate storm surge, earthing and lightning protection shall be provided and installed.

49. **Waste bunker.** The waste bunker shall accommodate wastes to allow continuous operation of the WTE plant. The bunker shall be designed to meet all safety and environmental requirements including, but not limited to:

- (i) General work safety, by, e.g., assuring sufficient signaling and warning notices;
- (ii) Prevention of falling into the bunker (through, e.g., handrails, providing secured maintenance or service platforms etc.);
- (iii) Prevention of fire incidents by a constant fire detection via an infrared fire detection system;
- (iv) Installation of an automatically controlled and monitored (with manual override from the crane control room) fire detection and suppression system with at least four externally controllable fire monitors;
- (v) Heat and smoke extraction system meeting the requirements of both the local fire department and the Contractor's insurance company; and
- (vi) Avoidance of odor emissions by extracting primary combustion air from the bunker.

50. The bunker design shall consider a parking position for the redundant crane and an aperture that, under normal operations, is kept closed to facilitate the grapple's maintenance outside the bunker. Access to the bunker from the roof shall be provided to access the crane bridges and rails for maintenance or replacement. CCTV system shall be installed to allow the crane operators to survey bunker areas out of their sight and the control room personnel to monitor the crane operations and the waste feeding into the feeding hoppers of the subsequent process unit.

51. The design includes a leachate collection sump which shall be used to collect leachate during bunker revisions and inspection only. Any accumulated leachate shall be disposed of via the combustion system after the system is back to operations.

52. **Waste crane.** The waste supply to the feeding hoppers shall be secured by two identical waste cranes. The cranes shall allow operations in an automatic, semi-automatic and a manual (override) control mode. Manual operations shall facilitate the operations of the cranes from the crane control room which shall provide the necessary control devices. The control room's window

shall be fire and impact resistant according to international standards. The control room shall be equipped with air conditioning.

53. The cranes shall be equipped with automatic load cells to weigh the waste quantity and log the feeding data (time, quantity) within the DCS. Load cells shall be calibrated by an accredited third party or by the supplier who shall certify the accuracy. The cranes and their rails shall be designed for high durability (24/7 operations in a dust laden environment at high temperatures), easy maintenance (e.g. double-sided maintenance walkway along the bridge) and safe operations (e.g. anti-collision system, IP65 protection class). The design of the waste cranes shall consider, among others, the standards of crane safety BS 7121, BS EN 13000 and BS EN 12077-2, and with BS EN 13001-3-1 dealing with design and material aspects. The crane shall meet FEM 1.001 standard A8 with mechanism groups for hoist (M8), travelling drive (M7) and trolley traversing drive (M7).

54. **Waste oil storage and feeding system.** As per feasibility study, an amount of approximately 1 m<sup>3</sup> waste oil per day is expected to be delivered to the WTE plant. Waste oil will be delivered in drums (up to 200 liters each). To accommodate the fueling of waste oil, the design includes waste oil storage, the necessary supply pumps to the waste oil lances including supporting steel structure, piping, instrumentation and control.

## 2. Thermal System

55. For each of the thermal systems to be delivered, the Contractor shall provide an identical set of components from the waste feeding hopper, to the combustion chamber including air supply system and wet de-asher and the two-boiler incl. economizer. Each of the thermal trains shall be capable being operated independently from the other. Each thermal system shall be designed to burn waste within the range of net calorific values and composition and for the defined throughput range as per preliminary stoker capacity diagram (as specified in bidding document) without any auxiliary fuel, and shall achieve the bottom ash characteristics as defined in bidding document.

56. At maximum thermal overload conditions (110% MCR per line), each thermal train shall allow operations for at least 2 hours every 4 hours. Intake of any air other than via the primary or secondary air supply system or discharge of any gaseous combustion products either via the feeding system or the bottom ash discharge shall be prevented under all operational conditions.

57. Appropriate fail-safe systems shall prevent access to or operation of the combustion system whenever necessary. Access doors to the furnace, which shall be sufficient in number and size, shall be locked automatically while the system is operating. Feeding waste shall be blocked if the temperature in the combustion chamber is below 850 °C. Lubrication and grease of moving components shall be arranged centrally for ease of control and maintenance. Other minimum design requirements for components and equipment are listed in bidding document.

58. **Feeding hoppers, waste chute and waste feeder.** Feeding hoppers shall facilitate blockage-free feeding of waste towards the waste chutes. Both the waste crane grapple and the feeding hopper shall allow the grapple to intervene in the event of any clogging of waste in the feeding hoppers. The design of the feeding hopper shall use wear resistant and replaceable steel sheets.

59. Similar to the feeding hoppers, the waste chute shall assure non-clogging operation characteristics via an appropriately shaped widening of the chute towards the furnace. The waste chute shall be equipped with a hydraulically driven cut-off gate and expansion joints and shall be

water cooled. The cut-off gate shall have fail-safe provisions (e.g. in the event of a low waste level) to prevent back-firing from the furnace into the bunker. Materials for the cut-off gate shall be corrosion resistant. The DBO contractor shall provide suitably designed fire alarm, firefighting and fire suppression equipment.

60. Waste shall be fed into the furnace via a hydraulically driven waste feeder, which shall be controlled by the DCS to allow the desired feeding rate. The pusher walls shall be made of wear resistant steel.

61. **Moving grate.** Design and assembly of the moving grate shall ensure a robust and durable non-clogging, easy to clean, operate and maintain system which shall limit downtime due to failure or breaking of grate bars and other driving or moving components. The design of the grate and the material used for the grate bars shall have a proven track record of at least 3 years continuous operation in other facilities incinerating co-mingled MSW.

62. All grate zones shall be designed to be controlled and operated individually. Cooling of the grate shall be provided via the primary air. Air flow for the grate zones shall be adjustable individually. The moving grate components shall be driven hydraulically. No unburnt material shall accumulate beneath the grate.

63. Operations and control of all grate components shall be realized automatically via the DCS.

64. **Bottom ash collectors and discharge system.** Bottom ash collectors beneath the grate and a wet de-ashing system shall be provided. All bottom ash collecting and conveying equipment shall be wear resistant, easy to clean, and easy to operate and maintain. Necessary flexible compensators shall be supplied. Access to the discharge system shall be provided through adequately designed apertures to remove any blocking objects or for inspection purposes. Dust emissions from the bottom ash discharge, collection and conveying system shall be prevented.

65. The design of the bottom ash conveying system downstream of the wet de-asher shall incorporate any needed redundancy or intermediate storage to avoid shut down of the combustion system or the subsequent units due to failures of the conveying system. During continuous and steady state operations, bottom ash shall be conveyed without any intermediate manual handling to the bottom ash processing plant.

66. **Combustion chamber.** The design of the combustion chamber above the grate after injection of secondary air shall take into account the combustion conditions pursuant to the Performance Guarantees that are included in the DBO contract (i.e. at least 2s residence time at a minimum temperature of 850 °C) under all operating conditions. The design shall be substantiated by CFD simulations which shall form part of the Contractor's detailed design documentation. The combustion chamber shall be equipped with measuring devices to allow the proponent to verify combustion conditions via an appropriate record of the DCS. The compliance of the combustion chamber with the combustion conditions shall be certified by an impartial external third party.

67. Any area exposed to flames shall be covered with appropriate materials. Design of the combustion chamber shall ensure a uniform flue gas distribution, an enhanced mixing efficiency of the secondary combustion air and minimizing fouling and/or slagging of the furnace walls. Walls of the water cooled combustion chamber shall be gas tight (membrane-type wall) and shall be covered by a back ventilated silicon carbide lining in those areas that are prone to flame impingement or shall be clad using an appropriate cladding material which shall be certified according to international standards.

68. All equipment to measure the parameters which are necessary to control the incineration shall be supplied. Data supplied by the measurement equipment shall be used by the combustion control system within the DCS to avoid unfavorable combustion and operating conditions of the incineration train such as, but not limited to, uneven oxygen and carbon monoxide concentration across the combustion chamber cross section, thermal overload, variation of steam generation rate, peak temperatures and to assure a complete combustion of the flue gases within the combustion chamber thus leading to minimum carbon monoxide and organic carbon emissions. To allow visual inspection, each combustion chamber shall be equipped with a sufficient number of apertures to both have a direct view on the grate and to install a CCTV camera.

### 3. Boiler and Water Steam System

69. The boilers and water-steam systems shall be designed to allow the heat extraction within the limits of the stoker capacity diagram including the required piping, insulation, valves and control equipment, and others. All components shall be easy to inspect, to maintain and to replace (e.g. via apertures in the roof, in combustion chamber or in the boiler passes). The boilers' operations shall be controlled by the DCS system.

70. In particular, the boiler and water steam system shall be designed with operation pressure of 42 bar (g) and steam temperature of 405°C. These design temperature and pressure shall be kept in the thermal load range between 85 and 110% MCR. If the thermal load range is between 70 and 85%, the steam temperature shall be maintained at 375°C.

71. The boiler and water steam system shall consist of radiation and convection boiler passes including evaporator, super heaters and economizer, steam drum and all necessary sampling, venting, injection, blow-down and cleaning equipment, and others that will be needed for safe operations of the boiler and the water steam system. The de-ashing equipment, including chutes, (pneumatic) conveying systems, compensators, and others shall be included in the scope of design and supply by the DBO contractor. All shut-off valves shall be fast-acting fulfilling the relevant internationally accepted standards.

72. All water/steam feeding pipes, safety valves, silencers and necessary pipe sections shall allow drainage. The necessary drainage shall be provided with a double shut-off fitting. The safety devices of the boiler shall likewise comply with applicable internationally accepted standards. A silencer shall be installed in the boiler safety valve blow-off. Each injection station shall include an injection control valve including a dirt trap, bypass and corresponding shut-off valves.

73. The protection of the membrane walls shall be taken into account. For the cladding, the following shall be considered:

Element	Percent by weight
Ni	minimum 58
Cr	20 - 23
Fe	5
C	0.1
Mo	8 - 10
Co	1
Ti	0.4



Element	Percent by weight
Al	0.4
Mn	0.5
Si	0.5
Nb (+ Ta)	3.15 – 4.15
Density	8.44 g/cm <sup>3</sup>

74. The cladding shall be applied with a thickness of 2 mm in total and an overlapping of 30 - 50% of each welding line. The service life of the cladding shall be at least 3 years, calculated from the application.

75. The steam drum, made of alloy steel, shall be dimensioned so that a sufficiently large water reserve is available. Extended boiler travel times shall be achieved by applying, among others, appropriately designed:

- (i) Gas velocities to prevent local overloads particularly in convection passes, entrainment of fly ash and its deposits;
- (ii) Transverse divisions sufficiently large and decreasing in exhaust flow directions;
- (iii) Cooling of the exhaust gas before the final super heater (super heater 3) to a maximum of 650 ° C (at 100% load, end of travel time);
- (iv) Evaporator bundle (protective evaporator) prior to the final super heater;
- (v) Co-flow arrangement of the final superheater;
- (vi) Aligned arrangement of all pipes;
- (vii) Live steam pipes with minimum welded joints;
- (viii) Mechanical and water jet cleaning devices.

76. The boiler lining in the first pass shall be optimized to meet the following requirements:

- (i) Good ignition of the fuel on the grate (ignition cover);
- (ii) Good burnout of the fuel on the grate;
- (iii) Protection of the pipe walls against erosion by the fuel on the grate and in the filling area;
- (iv) Insulation of the combustion chamber and the afterburner chamber to achieve the required residence times of the exhaust gas at high temperatures;
- (v) Protection of the pipe walls against hot and not completely burnt off exhaust gases (corrosion protection);
- (vi) Minimize heat accumulator for varying heat dissipation due to varying fuel throughput and calorific value; and
- (vii) Avoiding too high surface temperatures (low heat transfer resistance of the design where possible) to avoid caking, deposits and slag flow.

77. Each boiler shall allow independent operation from the other.

#### **4. Air Pollution Control System**

78. The air pollution control (APC) system of the WTE plant shall be equipped with dry flue gas cleaning with a reactor, sodium bicarbonate injection and limestone, activated carbon injection, bag filter and selective non-catalytic reduction (SNCR) for NO<sub>x</sub> to meet the emission limits as stated in the Performance Guarantees required from the DBO contractor. While the government does not have any emission standards, the WTE plant will comply with the emission

limit values stipulated in Annex VI of Directive 2010/75/EU of the European Parliament and the Council. The APC system shall be designed so that bypass operations are not required.

79. **Flue gas cleaning.** The reactor shall be designed so that flue gases sodium bicarbonate, limestone and activated carbon are mixed efficiently. For the regulation of the flue gas temperature, a quench with water shall be provided. The residues from the landfill leachate treatment shall be disposed of via the reactor. The bag house filter shall be designed with a maximum filter surface area load of  $0.8 \text{ m}^3/\text{m}^2 \text{ min.}$  and a maximum operation temperature of  $200^\circ\text{C}$ . The pressure loss shall be smaller than 14 mbar. The bag filter shall be equipped for fully automated and controlled (by differential pressure measurement) cleaning of the filter hoses by compressed air impulses. The separated dust shall be transported via a water-cooled discharge screw into a big-bag filling station. The filled big bags shall be stored in a separate area of the adjacent landfill.

80. **Nitrogen oxide removal system.** The  $\text{NO}_x$ -removal system shall be a selective non-catalytic reduction (SNCR). With a SNCR-system ammonia water with ammonia content of less than 25% or a water-urea solution shall be injected in the first pass of the boiler at a temperature level of approximately  $900^\circ\text{C}$ . The system shall be required with 3 levels of injection nozzles in the first boiler pass. The tank for the ammonia water shall be an unpressurized vessel with a capacity of  $30\text{m}^3$ .

## 5. Turbine, Generator and Condenser

81. **Steam turbine.** The turbine generator set shall include all necessary ancillaries to supply process steam and electrical energy to satisfy the demand at the project site and to export electricity to the STELCO grid based on the power purchase agreement to be concluded between the proponent and STELCO.

82. The turbine shall allow a steam intake equivalent to 110% MCR of both boilers. The exhaust steam of the steam turbine shall be cooled down in a seawater-cooled condenser in the energy building. The condenser and the hereto relating cooling water pumps shall be designed to facilitate the condensation of 100% of the steam generated in the boiler if needed. The turbine generator set shall allow both island mode and external grid-backed operations.

83. **Steam turbine with auxiliary equipment.** Besides the steam turbine itself, the system shall include all auxiliary equipment such as, but not limited to, valves, internal pipes, extraction points, gearbox, instrumentation, and lubricating system including oil coolers and filters that are required for fully automated and safe operations. Crucial equipment shall be installed redundantly. The turbine shall be single-casing design in axial construction. Thermal stresses during load changes or temperature fluctuations shall be reduced to a minimum. To satisfy steam and operating conditions, the housing shall be made of alloyed cast steel. The fast closing valve shall be medium-actuated that shall close in the event of malfunction in milliseconds. The nozzle segments shall be designed for a wide load range between 35% to 110% of the MCR (thermal). The exhaust housing is selected from the modular system and - depending on size and type of turbine - shall be cast or welded. The turbine rotor shall be designed as a fully forged rotor. The torsion-critical calculation shall be carried out using modern computer calculation methods. In particular, the vibrations are pre-calculated and minimized, taking into account the bearing conditions as well as the influence of the plain bearings. The design shall minimize the start-up time and shall allow fast load changes. All rotor blades material shall be a steel with not less than 13% chrome.

84. The steam turbine and auxiliary components shall be mounted on a single frame and shall be packaged by one supplier. Insulation of the turbine and its internal piping must not contain any asbestos. Equipment and components that are crucial for the facility and the turbine performance shall be provided fully redundant (2 x 100%), such as, but not limited to, oil coolers, pumps and filters. For failures of the steam turbine, a bypass shall be provided, which directs the live steam directly into the condenser.

85. **Generator System.** The generator shall be a four-pole rotor (1,500 min<sup>-1</sup>), of a brushless design using rotating diodes for excitation, and cooled by a closed air-cooling circuit. The heated air shall be re-cooled over cooling water. The design shall be selected in such a way that the generator does not suffer damage by water.

86. **Condenser.** The exhaust steam from the steam turbine shall be cooled in a 2-flow seawater surface condenser that shall be designed for bypassing the entire steam rate generated at 110% MCR of the two incineration trains in the event the turbine trips. To start the turbine, a vacuum shall be generated in the condenser using two parallel water ring pumps. In order to maintain the vacuum in the condenser during operation, a standby water ring pump shall be provided. Alternatively, the vacuum may also be generated via steam emitters. The condensate shall be collected in the hot well and pumped by the redundant condensate pumps into the condensate collecting tank.

## 6. Induced Draft Fan and Stack

87. The induced draft (ID) fan shall be arranged downstream of the bag house filter. This shall be designed as a radial fan with a single-flow impeller, statically and dynamically balanced. The shaft shall be double-mounted. A labyrinth shaft seal shall be provided as a shaft seal. An elastic coupling shall be used between the drive motor and the shaft. The housing shall be designed as a steel plate construction with external stiffeners. The fan is installed together with the drive motor on a steel base frame and is equipped with a noise protection hood.

88. The auxiliary driver shall be supported by emergency power. The ID fan shall be designed for 130% load at a nominal flue gas flow. In order to minimize the wear and the noise emission the maximum air fan speed shall below 1,200 rpm.

89. Two stacks shall be built as a tube-in-tube system, the minimum stack height based on the calculations in the air dispersion modeling done for the project is 45.7 m. However, the project will use 50 m as the height. Each stack shall be accessible via an external climbing ladder.

## 7. Continuous Emission Monitoring System

90. Each of the two stacks will be provided with a continuous emission monitoring system (CEMS), including the necessary flue gas sampling ports for emission measurements. The flue gas sampling ports shall be located at an appropriate height above the ground that shall allow easy access.

91. In addition to the continuously measured parameters and monitoring requirements discussed in Section IX, the pressure, flue gas temperature and flow, oxygen, water and carbon dioxide concentration shall be also continuously measured. The flue gas samples shall be routed via heated pipes to avoid condensation under all operating conditions to the measuring room or a measuring container. The analyzers shall be installed in cabinets. In addition, a computer and the holders for the test gas cylinders (zero gases and calibration gases), sample gases and carrier

gases shall be arranged in the measuring room. The measuring room or container shall be air-conditioned. The analyzers shall be equipped with a periodically self-calibrating system using the test and calibrating gas. Each analyzer shall be provided with a suitable measurement range to allow the collection of emission data beyond the half hourly emission standards without compromising the accuracy in its lower measurement range. The measuring instruments used shall comply with internationally accepted standards.

92. Raw emission data shall be compiled by the emission evaluation program to facilitate emissions statements according to the regulatory requirements. The emissions computer shall be equipped with special software, e.g. according to DIN EN 16258, which fulfills the following requirements:

- (i) Formation of overage values;
- (ii) Correction calculation for O<sub>2</sub>, temperature, pressure and flue gas humidity;
- (iii) Simultaneous calculation of the concentration; and
- (iv) Archiving the raw data and the classified averages values with date and time stamp for stamp minimum 5 years.

93. All measurement results shall be forwarded to the DCS and be displayed in the central control room. Results shall be submitted to the project management unit (PMU) for its review with the help of the external environmental expert who will be retained under the project. The same shall be submitted to ADB in accordance with the reporting requirements in Section IX. Subject to government requirements, the emission data shall also be transmitted to Maldives EPA.

## 8. Condensate System

94. The condensate system shall consist of the condensate collecting system, the condensate tank and the make-up water system.

95. **Condensate collecting system.** A hotwell shall be arranged in the condenser at the lowest point in which the condensate from the turbine exhaust is collected. With a redundant condensate pump, the condensate shall be pumped to the main condensate tank. All other condensate from internal heat exchangers, air-pre-heaters etc. shall be collected in a separate condensate tank and pumped into the main condensate tank.

96. **Main condensate tank.** The condensate tank shall be designed as an insulated horizontal tank. The size of the main condensate tank shall be adapted at the maximum condensate flow. The minimum storage capacity shall be not lower than 15 m<sup>3</sup>.

97. **Feed water.** The condensate shall be pumped in the boiler feed water tank which shall be designed as a horizontal preheater. The preheater shall be operated by LP steam. The volume of the boiler feed water tank shall be not smaller than 35 m<sup>3</sup>, the degassing capacity not smaller than 70 m<sup>3</sup>/h.

98. **Boiler feed water pumps.** Each boiler shall be equipped with 2 x 100% electrical driven feed water pumps. The boiler feed water pumps shall be connected to the emergency power system for a save shut down of the plant. The design shall be according to internationally recognized standards.

99. **Make-up water system.** A water treatment plant producing the make-up water shall be able to supply a full boiler filling within 24 hours. The conductivity of the make-up water shall be

lower than 0.2  $\mu\text{S}/\text{cm}$ .

## **9. Cooling Water Supply System**

100. The WTE plant shall include a cooling water supply system utilizing sea water-cooled heat exchangers (mainly the condenser). Cooling water shall be returned to the sea with a maximum temperature of 38°C. The design of the cooling water supply system shall take into consideration the recommendations in this EIA, which is aimed at protecting sensitive coral fauna and flora and the marine ecosystem in general. The cooling water intake position and cooling water outfall position shall follow the recommendations of the EIA. Design implications are, but are not limited to, inlet and outlet pipe position, and supporting structure of the inlet and outlet pipes.

101. For the design of the cooling water pumps, the DBO contractor shall take into account that the pumps shall be:

- (i) installed in an enclosed, watertight area to cope with the climate change and disaster risks;
- (ii) fully redundant; and
- (iii) designed to accommodate the instant need to cool down the full steam flow rate bypassing the turbine.

102. The cooling water collected from the intake shall be appropriately cleaned prior to its use in the facility to limit fouling of the condenser (or any other heat exchanger).

## **10. Fuel and Chemical Supply and Storage**

103. The tanks and silos shall be designed to prevent the occurrence of encrustation and deposits. Necessary monitoring equipment such as but not limited to leakage detection shall be installed for all hazardous substances. This shall also apply to securing against vacuum, e.g. by suction during emptying. All containers shall be equipped with manholes and associated maneuvering aids.

104. The manholes shall be opened without the aid of hoists. Trays of containers shall be diverted appropriately via the channel and pumping sump. Odor emissions shall be prevented. For chemical containers, sufficient retention volume shall be provided.

## **11. Piping and Valves**

105. Installation lengths and connection dimensions of fittings shall be selected according to internationally recognized standards. For fittings and piping components, at least certificates of the acceptance test in the factory and a 2.2 certificate in accordance with BS EN 10204 for mechanical-technological tests shall be submitted. For materials of stressed pipelines (e.g. thick sludge lines), approval test 3.1B according to BS EN 10204 shall be submitted.

106. Fittings for insulated pipelines shall be equipped with spindle extensions, if necessary. All fittings shall be supplied with a full corrosion protection (including the hand wheels and chain wheels) in the factory, in accordance with the customer's order. Fittings and piping components shall be equipped with factory-specific markings. For fittings these are nominal size, nominal pressure, permissible operating temperature and pressure, type, year of manufacture, material manufacturer or manufacturer's code, and flow direction. Whereas for piping components, these

are manufacturer's mark, material, melting number (percent), if relevant, nominal pressure for flanges, and dimensions (nominal width and pipe connection).

## **12. Pumps**

107. Dry-mounted pumps shall be delivered on suitable base plates or base frames pre-assembled for installation including motor and coupling. The aligned arrangement of engine-clutch-pump shall be measured and, if necessary, adjusted. Pumps shall be designed in horizontal design and shall be able to absorb cavitation in the short term. The material of the pumps shall be capable of continuous operation under the appropriate conditions of delivery and operation. Pumps shall have a stable characteristic and shall allow a quick start from the cold conditions without prior warming.

108. Sliding ring seals of the pumps shall preferably be made of silicon carbide or wolfram carbide. Seals, which are exposed to sealing water are equipped for a continuous monitoring and recording of the flow or pressure or temperature.

109. All pumps shall be provided with dry-running protection. Pumps with a motor power of 20 kW shall have a bearing temperature monitor. Suitable shut-off devices before and after the pumps shall be provided so that the pumps can be replaced at any time.

## **13. Compressed and Instrument Air Supply**

110. The DBO contractor shall design and install a fully redundant compressed air supply plant for the provision of dry, particle and oil-free compressed air that allows an energy optimized supply at 110% MCR of each incineration train. The compressed air supply unit shall consist of the following systems:

- (i) A compressed air supply system for continuous consumption such as but not limited to, cooling air for furnace cameras, SNCR, sealing air, and temporary consumption for, amongst others, tools, cleaning purposes etc. Drying shall be achieved by refrigerant cooling (dew point 3°C, at max pressure), filtration rate with grain size 3 µm 99.99%;
- (ii) An instrument air supply system for all measurement and control instrumentation meeting the quality requirements of the measuring and instrumentation devices. Based on the design considerations of the Contractor, the instrument air shall be either made up from compressed air or a completely separate supply system shall be installed (with refrigerant cooling, 3°C dew point, adsorption drying, -40°C dew point, and filtration rate of 99.99% with grain size 0.01µm);
- (iii) It shall be at the Contractor's discretion to supply a compressed and instrumentation air supply system either catering for 2x100% or a 3x75% of the required capacity. In any case, the supply of the compressed and instrument air shall be secured any time without any interruption;
- (iv) The compressed air system shall be soundproofed and operated fully automatically;
- (v) The compressed air lines shall be made of stainless steel; and
- (vi) Sufficiently sized tanks with pressure relief valves shall be provided for both compressed air and instrument air.

111. Consumers shall be supplied via a redundant supply line or via a ring supply system.

#### 14. Thermal Insulation and Heat Protection

112. All equipment or components carrying media at elevated temperatures or at temperatures below ambient conditions or that, due to its operations, work at such temperatures shall be provided with thermal insulation to assure high energy efficiency and to prevent condensation or shall be covered with heat protection shields to avoid accidental contact. The thermal insulation design shall be in accordance with the requirements set in the contract documents.

113. The thermal insulation shall be designed so that the maximum temperature the working personnel are exposed to does not exceed 60 °C whenever feasible or shall install heat protection shields when the maximum surface temperature of any equipment which cannot be insulated exceeds 60 °C. It shall be designed so that no heat losses or condensation occur via pipe and equipment supports and that valves, fittings and measurement devices are accessible yet are covered by insulation material. For the design of the insulation thickness, it shall consider the maximum heat flow due to operational conditions, such as, but not limited to, maximum inner temperature and by-passing the turbine.

114. No asbestos shall be used for thermal insulation but only non-flammable, chemically and highly durable resistant rock wool mats. The mats shall not have any chemical impact on the base material. Materials shall comply with internationally recognized standards such as BS 5970 and BS 5422. Pipes or components working below ambient temperatures shall be insulated using flexible elastomeric foam material in accordance with BS 5422.

115. The lagging and jackets shall meet the ambient conditions of the marine corrosive environment, accommodate the thermal expansion of pipes and equipment and that shall allow access to base materials, valves, fittings, flanges, measuring devices and other equipment.

#### 15. Lifting Devices

116. The WTE plant shall have all required lifting devices during the operations phase and shall provide either permanent or temporary (including attachments) lifting devices such as cranes and hoists. The surrounding steel structure of the equipment shall be designed to allow anchoring or attaching temporary lifting gear if needed via mounting additional beams, clamps, shackles etc. or directly to the steel structure. A permanent crane shall be installed in the turbine hall. Removable openings in the roof of the machinery hall shall allow the access via mobile cranes to lift larger components that cannot be moved otherwise.

#### B. Environmental Considerations in Project Design

117. During the feasibility study stage for the project, household, resorts and hotels and general domestic waste generation in Maldives was assessed and characterized. Results of the study revealed waste composition in Table 1 and Table 2 below.<sup>24</sup>

**Table 1: General Waste Composition**

Waste composition	Household %	Hotel %
<b>Organics</b>	60	74
Garden waste	10	10

<sup>24</sup> Feasibility Study for an Integrated Solid Waste Management System for Zone III (including Greater Male') and Preparation of Engineering Design of the Regional Waste Management Facility at Thilafushi. Ministry of Environment. Maldives. March 2018.

<b>Waste composition</b>	<b>Household %</b>	<b>Hotel %</b>
kitchen waste	40	54
other organics	10	10
<b>Paper and cardboard</b>	10	9
<b>Glass</b>	3	5
<b>Plastics</b>	10	5
<b>Metals</b>	4	2
<b>Hazardous waste</b>	3	0.5
<b>Others (inert and dust)</b>	10	4.5
Combustible	39 – 50% (OS)	
Water	18 – 33% (OS)	
Ash	23 – 35% (OS)	

**Table 2: Elemental Composition of Domestic Wastes**

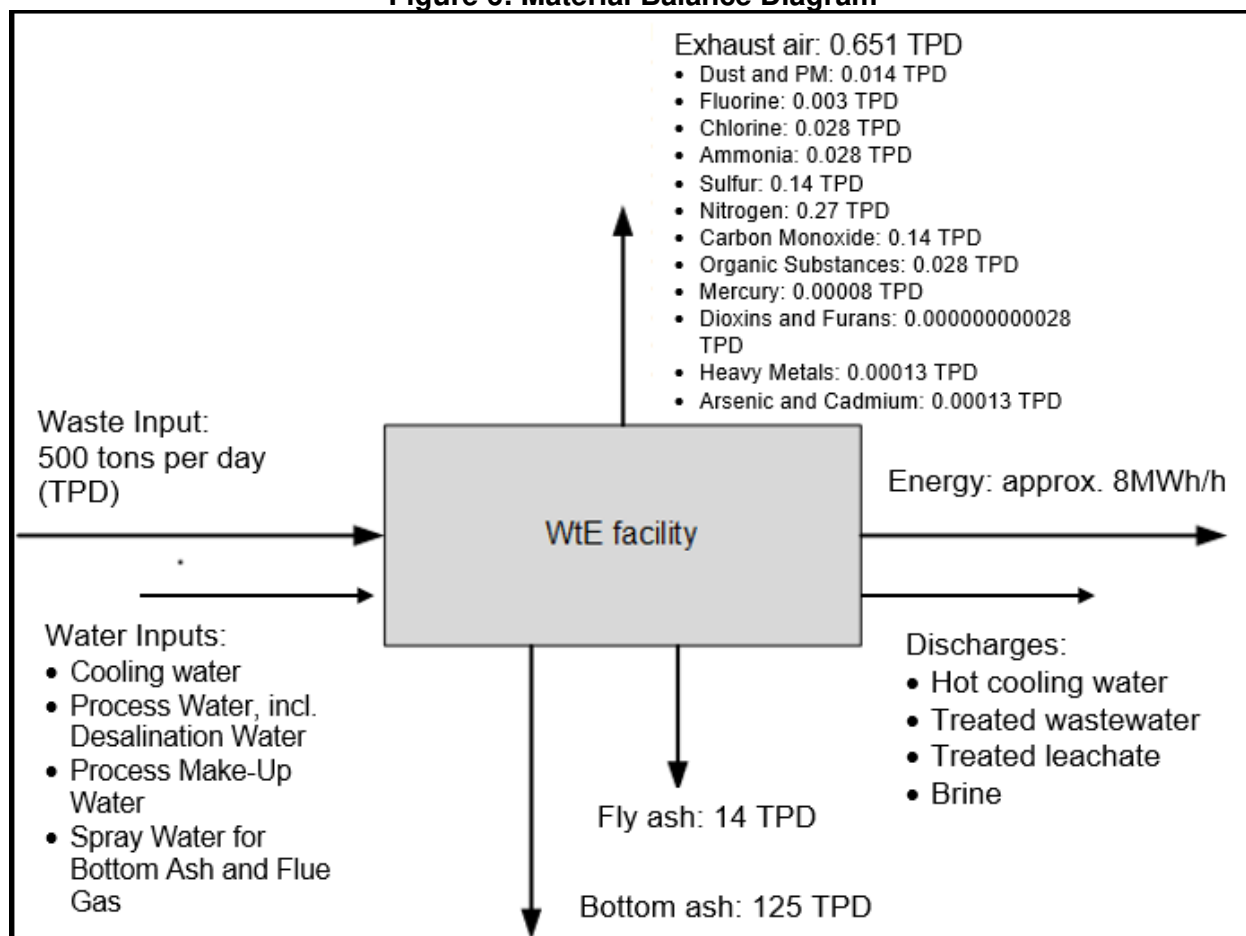
<b>Parameter</b>	<b>% Composition</b>
Combustible	40 %
Water	31 %
Ash	29 %
Ash (dry)	42%
C (Carbon)	29.9 % (dry)
S (Sulphur)	0.4 % (dry)
H (Hydrogen)	4.4 % (dry)
O (Oxygen)	18.1 % (dry)
N (Nitrogen)	0.9 % (dry)
Cl (Chloride)	0.6 % (max. 1 %) (dry)
F (Fluoride)	0.1 % (dry)

118. Figure 6**Error! Reference source not found.** below illustrates the material balance of input solid waste materials and output streams during full capacity operation or when the two lines are in full operation. It also shows the generated energy expected from the WTE plant operation.

119. During the feasibility study for the project, several strategies following the waste hierarchy (waste prevention, followed by preparing for reuse, recycling, other recovery and finally disposal as the least desirable option) have been assessed in terms of applicability in the Maldives. Accordingly, not all common waste management strategies are applicable in the country. Notwithstanding the establishment of the WTE project, the government, through its various laws, rules and regulations, shall continuously promote its programs on waste prevention. During the operation phase of the WTE project, all possible waste recycling options proven to be sustainable under the situation in Maldives shall continue as well (e.g. recovery and recycling of PET bottles through partnerships with NGOs). However, recovery and recycling of other materials may not be applicable and/or practical due to limited land or space and the lack of recycling facilities in the country. Bringing these other recyclable materials overseas is not a financially sustainable option. Ultimately, these waste materials will have to be treated in the WTE plant. Nevertheless, any potential environmental impacts of burning these wastes will be addressed in the detailed design of the project, including adoption of internationally accepted and proven measures as discussed in various sections of this EIA report.



Figure 6: Material Balance Diagram



120. **Air Emission.** The WTE plant will be designed to include air emission control system and infrastructures in order to ensure no significant impact to the environment occurs. Consistent with Table 8 in Section II, the WTE plant will be designed to meet the target emission limits as shown in Table 3 below. These mass concentration limits are integral part of the performance guarantees provided under the DBO contract of the project.

Table 3: Air Emission Limits for the Waste-to-Energy Plant

Substance	Mass concentration <sup>a</sup>	Unit	Averaging Time
Total Suspended particulates (PM <sub>10</sub> )	10	mg/m <sup>3</sup>	24 – hour
Sulfur Dioxide (SO <sub>2</sub> )	50	mg/m <sup>3</sup>	24 – hour
Oxides of Nitrogen (NO <sub>x</sub> )	200 – 400	mg/m <sup>3</sup>	24 – hour
Hydrochloric Acid (HCl)	10	mg/m <sup>3</sup>	
Dioxins and furans,	0.1	ng TEQ/m <sup>3</sup>	6 – 8 - hour
Cadmium	0.05 – 0.1	mg/m <sup>3</sup>	0.5 – 8 - hour
Carbon Monoxide (CO)	50 – 150	mg/m <sup>3</sup>	
Mercury (Hg)	0.05 – 0.1	mg/m <sup>3</sup>	0.5 – 8 - hour
Hydrogen Fluoride (HF)	1	mg/m <sup>3</sup>	
Sum of heavy metals and their compounds as Antimony, Arsenic, Lead, Chromium, Cobalt,	0.5	mg/m <sup>3</sup>	Between 30 min. and 120 min.

Substance	Mass concentration <sup>a</sup>	Unit	Averaging Time
Copper, Manganese, Nickel, Vanadium, Tin, Zinc			
Cadmium/Thallium and compounds expressed as Thallium/Cadmium	0.05	mg/m <sup>3</sup>	Between 30 min. and 120 min.
Arsenic/Cadmium and their compounds (As and Cd), Benz(a)pyrene, water soluble Cobalt compound (as Co), Cr(VI) compounds as C	0.05	mg/m <sup>3</sup>	Between 30 min. and 120 min.

<sup>a</sup> related to 11% O<sub>2</sub> in the flue-gas.

121. In conjunction with the design, an advanced air pollution control (APC) system, including selective catalytic reduction (SCR) for nitrogen oxides (NO<sub>x</sub>) removal, activated carbon for removal of dioxins and furans, bag filters for particulates removal, a dry/semi-dry scrubber for acid gas removal, and a continuous emissions monitoring system (CEMS) will be installed for the WTE plant to ensure that the emissions from the stacks will meet the target emission limits.

122. **Stack Height.** The stack height has been established through the use of modeling. More discussion on the modeling are in Section VI. Details of the modeling report is in Appendix 5. The assessment was done with reference to the Technical Instructions on Air Quality Control (TIAQC). TIAQC sets out the standards applied for air quality control in Germany and complies with the European Commission (EC) Directive on the Incineration of Wastes. The stack height required to comply with the technical instruction was determined, following which concentrations of pollutants in the emissions from the WTE were predicted, and dispersion modeling undertaken for those exceeding a designated minimum level.

123. Determination of the requisite stack height was undertaken using a nomogram and calculation steps provided in the German TIAQC. The input values for this process are the inside diameter of the stack, the temperature of the waste gas at the mouth of the stack, the volume of flow of the waste gas in standard conditions after subtraction of the water vapor content, and the rate of emission mass flow of the air pollutants from the plant. In determining these parameters, a feed of 500 tons of household waste per day was assumed. The final stack height is determined based on the dimensions of adjoining buildings. Results of the modeling and calculations show that stack height needs a minimum 45.7m to ensure sufficient dilution of the exhaust gases and an undisturbed transport with the free air flow is ensured. As added measure, 50m has been selected as the stack height. Summary of the stack description, including the other parameters used in the modeling is in Table 4 below.

**Table 4: Parameters Used in Stack Height Calculations**

<b>Number of Stacks</b>	<b>2</b>
Distance between stacks	7 m
Diameter of each stack	1.5 m
Calculated equivalent diameter of the two stacks	2.12 m
Total emission area	3.53 m <sup>2</sup>
Flue gas volume stream for each stack	57,856 m <sup>3</sup> /h
Total Flue gas volume stream for both stacks	115,712 m <sup>3</sup> /h
Flue gas exit temperature	180° C
Ambient air temperature	293 K

124. **Cooling System.** The heat energy of the exhaust air from the furnace is transmitted to water, converting the water to high pressure steam. The high-pressure steam is used to rotate a steam turbine and generate electricity. After the electricity generation process, steam pressure is reduced, and the steam is further cooled down by a cooling system. The proposed cooling system uses a seawater-cooled condenser and involves exchange of the heat of the low-pressure steam to sea water, which is then discharged to the sea at the southern side of Thilafushi. Selection of the outfall location for the hot condenser water has been analyzed based on where the minimum or no impact to marine life is expected. Discussions on the location selection is included in Section IV on alternatives analysis.

125. An alternative cooling system using an air-cooled condenser, was considered. An air-cooled condenser involves exchange of the heat of the low-pressure steam to air, which is then discharged to the atmosphere. This kind of system was not considered to minimize the land requirement at the proposed site.

126. **Desalination Unit.** An on-site desalination plant will be provided for supplying water to the WTE plant. The desalination plant would involve membrane separation of dissolved ions such as chloride ions from seawater, and would not involve any boiling or burning processes. The equivalent volume to be processed by the desalination plant will be enough to cover the makeup water for the boilers, which is typically 0.5% of the boiler feed water throughput. The desalination plant will also be used as an alternative source of potable water supply at the plant if external source is not sufficient. The waste brine or concentrated saltwater with approximate volume of 14 m<sup>3</sup>/day from the desalination unit will be mixed with the hot water (heated cooling seawater) from the condenser. With relatively negligible volume of the brine (compared with cooling water volume), it is expected that it will not cause any change in concentration of the seawater and assimilation could be achieved as the flow reaches the outfall.

127. **Bottom Ash Processing Plant.** The DBO-Contractor shall be responsible for designing and building the bottom ash processing plant including bottom ash storage to satisfy the requirements of the envisaged bottom ash reuse. A study was commissioned under the project on the potential use of incinerator bottom ash for commercial purposes. Conclusion on the study says that the incinerator bottom ash has the potential for use in the construction industry. A copy of the complete report is in Appendix 6. For a proper and economical reuse of the bottom ash in the national market, the bottom ash shall have the following characteristics that allow the reuse of bottom ash as aggregate to concrete with different grading.

**Figure 7: Bottom Ash Requirement for Reuse**

Sieve size	Percentage by mass passing sieve
10 mm	100
5 mm	89-100
2.36 mm	60-100
1.18 mm	30-100
600 µm	15-100
300 µm	5-70
150 µm	0-150*
* For crushed rock sands the permissible limit is increased to 20%	

128. Subject to the design considerations of the DBO Contractor, an intermediate bottom ash storage shall be provided. The floor of the bottom ash storage hall shall allow run-off from the wet bottom ash via a drainage system. The drained run-off from the bottom ash storage area shall be forwarded after either mechanical or gravity cleaning to buffer tanks prior to the leachate treatment system. The intermediate bottom ash storage area shall be sized to accommodate short term stoppages in the conveying system (e.g. the overhead cranes and belt conveyors). Bottom ash storage areas shall be equipped with CCTV to monitor operations. The bottom ash conveyors shall be dimensioned such that any item able to pass the bottom ash discharge chute can be conveyed to the bottom ash processing plant within the bottom ash treatment building.

**Table 5: Design Parameters for Bottom Ash Treatment Plant**

<b>Bottom ash handling system (design parameter)</b>	
Ash content in SW (dry ash/wet)	Max. 35%
Water content in bottom ash downstream extractor	Max. 15%
Capacity	Min. 160% of the maximum bottom ash flow
Yield of grading < 3.35 mm	Min. 60% of mineral fraction

129. **Fly Ash Management.** To avoid any impact to the environment and to the DBO Contractor's personnel safety, the fly ash shall be conditioned safely in sealed bags and disposed in a controlled way at the sanitary landfill. Similarly, the fly ash collected from flue gas cleaning is cooled down, stored in big bags and disposed in the same sanitary landfill. The DBO Contractor shall follow the APC Residue or Fly Ash Management Plan attached as Appendix 6 in this EIA report. The DBO Contractor shall update the plan accordingly during the design phase, with the condition that no requirements therein shall be relaxed or removed. Consistent with this APC Residue or Fly Ash Management Plan, the DBO Contractor's design shall consider the following for conveying and loading APC residues or fly ash:

- (i) APC residues or fly ash shall not be mixed with bottom or boiler ash prior to the bottom ash treatment;
- (ii) APC residues or fly ash shall be conveyed in closed conveying systems that end up in storage silos whose exhaust air can be dedusted via a central dedusting system;
- (iii) The top of the bag filter housing shall be enclosed and shall be connected to the central dedusting system (while pulling/replacing bag-filter hoses);
- (iv) Discharging the APC residues or fly ash from the silos into water-tight jumbo bags (with inlet) or into the transfer vehicles shall be carried out via dust-tight discharging chutes;
- (v) APC residues or fly ash shall be treated by either stabilization/solidification or via triggered pozzolanic reaction prior to landfilling to limit the leachability of heavy metals;
- (vi) Landfilling of contained APC residues or fly ash shall follow the standards of landfilling hazardous wastes based on EU Directive on the Landfill of Wastes<sup>25</sup> as discussed in Table 6.

130. **Landfill for Residual Waste Disposal.** The DBO Contractor shall ensure that the design of the residual waste landfill will be able to accommodate the volume of all generated incinerator

<sup>25</sup> Council Directive 1999/31/EC of 26 April 1999 on the Landfill of Waste.

bottom ash and fly ash during the entire operation of the WTE Plant, with the assumption that no bottom ash will be recycled and/or reused. The DBO Contractor will include in the design the following criteria:

- (i) The landfill arrangement shall be designed to maximize the useable landfill volume of the site;
- (ii) The landfill cell arrangements shall be designed to allow for the progressive closure of individual landfill cells on completion and thereby to minimize the amount of leachate requiring treatment over the lifetime of the landfill;
- (iii) The design shall allow for the development of individual cells in a coherent and logical sequence and in a manner, which ensures the stability of all working faces and of the waste mound as a whole.
- (iv) The design shall incorporate appropriate back-up systems in the event of failure of any component of the environmental control and management systems;
- (v) The landfill concept shall be designed to minimize the lateral and vertical extent of the working face and thereby the amount of deposited waste that is exposed to the environment;
- (vi) The design shall ensure that waste can be deposited in a manner that prevents damage to the engineered barrier or liner, the leachate control system, and the collection and transfer system.
- (vii) The landfill design shall incorporate an internal access corridor to allow for safe traffic movement and to accommodate site services and monitoring devices;
- (viii) Measures shall be provided for controlling unauthorized access to the landfill including, as appropriate, the provision of ditches, berms, planting and fencing;
- (ix) Slopes shall be graded to ensure long term slope stability. Graded slopes shall be a maximum of 25%;
- (x) Soil erosion and dust generation shall be minimized;
- (xi) All landfill construction materials shall be free of organic matter and debris;
- (xii) Measures shall be provided to monitor and manage groundwater beneath and adjacent to the landfill area.

131. With reference to the waste characteristics in Table 1, the wastes have the potential to contain hazardous substances. Therefore, both the bottom ash and fly ash may likewise contain these hazardous substances that could impact the environment if no sufficient measures are taken to contain them. In order to avoid this impact, the DBO Contractor shall design the landfill facility by applying international best practices on landfilling of hazardous wastes, such as the relevant requirements indicated in the EU Directive on the Landfill of Wastes (footnote 25). Table 6 below summarizes these requirements.

**Table 6: General Requirements for Hazardous Waste Landfills**

Design Parameters	Design Considerations and Requirements
Water control and leachate management	<p>Appropriate measures shall be taken, with respect to the characteristics of the landfill and the meteorological conditions, in order to:</p> <ol style="list-style-type: none"> <li>(i) control water from precipitations entering into the landfill body,</li> <li>(ii) prevent surface water and/or groundwater from entering into the landfilled waste,</li> <li>(iii) collect contaminated water and leachate,</li> <li>(iv) treat contaminated water and leachate collected from the landfill to the appropriate standard required for their discharge following Table 13 of this EIA report.</li> </ol>

Design Parameters	Design Considerations and Requirements																														
Protection of soil and water	<p>The landfill must be situated and designed so as to meet the necessary conditions for preventing pollution of the soil, groundwater or surface water and ensuring efficient collection of leachate as and when required. Protection of soil, groundwater and surface water is to be achieved by the combination of a geological barrier and a bottom liner during the operational/active phase and by the combination of a geological barrier and a bottom liner during the operational/active phase and by the combination of a geological barrier and a top liner during the passive phase/post closure.</p> <p>The geological barrier is determined by geological and hydrogeological conditions below and in the vicinity of a landfill site providing sufficient attenuation capacity to prevent a potential risk to soil and groundwater.</p> <p>The landfill base and sides shall consist of a mineral layer which satisfies permeability and thickness requirements with a combined effect in terms of protection of soil, groundwater and surface water at least equivalent to the one resulting from the following requirements:</p> <ul style="list-style-type: none"> <li>- landfill for hazardous waste: <math>K \leq 1.0 \times 10^{-9}</math> m/s; thickness <math>\geq 5</math> m,</li> </ul> <p>Where the geological barrier does not naturally meet the above conditions, it can be completed artificially and reinforced by other means giving equivalent protection. An artificially established geological barrier should be no less than 0.5 meters thick.</p> <p>In addition to the geological barrier described above a leachate collection and sealing system must be added in accordance with the following principles so as to ensure that leachate accumulation at the base of the landfill is kept to a minimum.</p> <table border="1" data-bbox="428 1079 1411 1308" style="margin-left: auto; margin-right: auto;"> <thead> <tr> <th colspan="3" style="text-align: center;"><i>Leachate collection and bottom sealing</i></th> </tr> <tr> <th style="text-align: center;">Landfill category</th> <th style="text-align: center;">non hazardous</th> <th style="text-align: center;">hazardous</th> </tr> </thead> <tbody> <tr> <td>Artificial sealing liner</td> <td style="text-align: center;">required</td> <td style="text-align: center;">required</td> </tr> <tr> <td>Drainage layer <math>\geq 0,5</math> m</td> <td style="text-align: center;">required</td> <td style="text-align: center;">required</td> </tr> </tbody> </table> <p>If the DBO Contractor finds that the prevention of leachate formation is necessary, a surface sealing may be prescribed. Recommendations for the surface sealing are as follows:</p> <table border="1" data-bbox="428 1438 1411 1766" style="margin-left: auto; margin-right: auto;"> <thead> <tr> <th style="text-align: center;">Landfill category</th> <th style="text-align: center;">non hazardous</th> <th style="text-align: center;">hazardous</th> </tr> </thead> <tbody> <tr> <td>Gas drainage layer</td> <td style="text-align: center;">required</td> <td style="text-align: center;">not required</td> </tr> <tr> <td>Artificial sealing liner</td> <td style="text-align: center;">not required</td> <td style="text-align: center;">required</td> </tr> <tr> <td>Impermeable mineral layer</td> <td style="text-align: center;">required</td> <td style="text-align: center;">required</td> </tr> <tr> <td>Drainage layer <math>&gt; 0,5</math> m</td> <td style="text-align: center;">required</td> <td style="text-align: center;">required</td> </tr> <tr> <td>Top soil cover <math>&gt; 1</math> m</td> <td style="text-align: center;">required</td> <td style="text-align: center;">required.</td> </tr> </tbody> </table>	<i>Leachate collection and bottom sealing</i>			Landfill category	non hazardous	hazardous	Artificial sealing liner	required	required	Drainage layer $\geq 0,5$ m	required	required	Landfill category	non hazardous	hazardous	Gas drainage layer	required	not required	Artificial sealing liner	not required	required	Impermeable mineral layer	required	required	Drainage layer $> 0,5$ m	required	required	Top soil cover $> 1$ m	required	required.
<i>Leachate collection and bottom sealing</i>																															
Landfill category	non hazardous	hazardous																													
Artificial sealing liner	required	required																													
Drainage layer $\geq 0,5$ m	required	required																													
Landfill category	non hazardous	hazardous																													
Gas drainage layer	required	not required																													
Artificial sealing liner	not required	required																													
Impermeable mineral layer	required	required																													
Drainage layer $> 0,5$ m	required	required																													
Top soil cover $> 1$ m	required	required.																													
Nuisances and hazards	<p>Measures shall be taken to minimize nuisances and hazards arising from the landfill through:</p> <ul style="list-style-type: none"> <li>(i) emissions of odors and dust;</li> </ul>																														

Design Parameters	Design Considerations and Requirements
	(ii) wind-blown materials; (iii) noise and traffic; (iv) birds, vermin and insects; (v) formation and aerosols; and (vi) fires.  The landfill shall be equipped so that dirt originating from the site is not dispersed onto public roads and the surrounding land.
Stability	The emplacement of waste on the site shall take place in such a way as to ensure stability of the mass of waste and associated structures, particularly in respect of avoidance of slippages. Where an artificial barrier is established it must be ascertained that the geological substratum, considering the morphology of the landfill, is sufficiently stable to prevent settlement that may cause damage to the barrier.
Barriers	The landfill shall be secured to prevent free access to the site. The gates shall be locked outside operating hours. The system of control and access to each facility should contain a program of measures to detect and discourage illegal dumping in the facility.

132. **Storm water collection system.** The Contractor's design shall include surface water and storm water collection and diversion systems in order to protect the landfill area and minimize the generation of leachate. Sedimentation ponds shall be established to contain polluted drainage and runoff containing soil and sediment.

133. **Leachate Treatment Plant (LTP).** The DBO Contractor shall ensure that design of the LTP will also follow applicable requirements in the EU Directive on Landfill of Wastes as enumerated in Table 6 in order to prevent leachate contamination of marine water and groundwater. Consistent with these requirements, the DBO Contractor shall also include the following requirements in the design of the LTP:

- (i) An acid and alkali resistant floor finish shall be provided for all sections of the leachate treatment facility that may be exposed to acid or lye;
- (ii) A drainage system shall be provided to collect liquids, spills etc. that is connected to the site's sewer system;
- (iii) A collection and disposal system shall be provided for reverse osmosis rinsing and flushing liquids;
- (iv) The necessary IT linkage shall be made to the site's LAN and telephone network and linkage to the DCS network;
- (v) The level of the engineered barrier shall be no deeper than 1.5 meters above mean sea level and in accordance with the applicable environmental standards;
- (vi) The leachate collection system shall provide for the progressive installation of control measures for the management of leachate;
- (vii) The design shall ensure that piping is not blocked by sedimentation, debris, algal or fungal growth and that structural integrity is maintained at all times;
- (viii) The system shall be capable of dealing with the maximum leachate flow at any time during the lifespan of the landfill;
- (ix) Leachate shall be treated to meet the effluent discharge standards;
- (x) The design shall provide for the segregation of surface water from leachate;

- (xi) The design and selection of materials for the leachate management and storage system and location of discharge point into the sea shall be discussed with, and approved by, the Maldives EPA.
- (xii) The design shall provide a suitable system for the transfer of leachate from the collection system to the leachate treatment plant;
- (xiii) Leachate levels shall be monitored continuously and shall be capable of being read electronically;
- (xiv) The leachate treatment system shall be capable of running automatically between and above specified leachate levels and volumes;
- (xv) Constructing a shed above the hazardous waste compartment, separating not contaminated water from leachate by installing gate valves, constructing bunds to control the leachate flows, etc.;
- (xvi) Leachate from different compartments for APC residues and residues from the bottom ash processing are collected and treated so that the leachate discharge standards are met any time. Applying strictest discharge standards is the only way to control the APC residue disposal in the Maldives case;
- (xvii) Subject to its design, re-inject the concentrate after the leachate treatment in the air pollution control system or shall evaporate it. In the latter case, the residues shall be disposed on the landfill so that no accumulation of the highly soluble material is to be concerned; and
- (xviii) Monitoring wells to detect any potentially escaping leachate shall be installed.

134. All components of the leachate collection, extraction, transfer and treatment system shall be capable of being maintained in a clean condition to ensure effective operation. Concentrate may be re-injected in the flue gas treatment process of the WTE plant. The Contractor shall design and build or organize a system for the re-injection of the LTP concentrate.

135. **Wastewater Treatment Plant.** An on-site wastewater treatment plant will be provided to treat the wastewater generated from floor/vehicle washing and from staff/visitors. The treated effluent will be reused in the incineration plant or for washdown and landscape irrigation within the RWMF. Efforts will be taken so that no effluent would be discharged to the ground or sea. Should wastewater be discharged, the DBO Contractor shall ensure the design of the wastewater treatment plant will comply with the effluent standards in Section III hereof.

### C. Project Layout Arrangement

136. The RWMF has been designed to provide long term environmentally sustainable solution for waste management in Project area of the Maldives. Limitations and scarcity of land and the requirement to protect the fragile eco-system have also been considered during the design of RWMF. With a view to minimize the land use and the associated environmental impacts, the preferred location for the WTE Plant was the area adjacent the old dumpsite of Thilafushi. This has the advantage to reduce environmental risks on another location and islands . The vocation of Thilafushi as an industrial island plays also in favor of a site location of the facility on this island.

137. The layout for the WTE Plant is considered appropriate, taking into consideration the functional need for operation of the WTE Plant, reasonable flexibility in design for the DBO contractor and allowance of suitable size of land for provision for the future. The design of the WTE Plant has been done considering factors such as waste composition, quantity reaching the WTE Plant, applicability in the local condition and regulatory compliance. Based on the proposed layouts, the footprint requirement for treating per tonnage of MSW daily is approximately 32 m<sup>2</sup>. The area for coastal protection, waste receiving area were excluded in the unit footprint



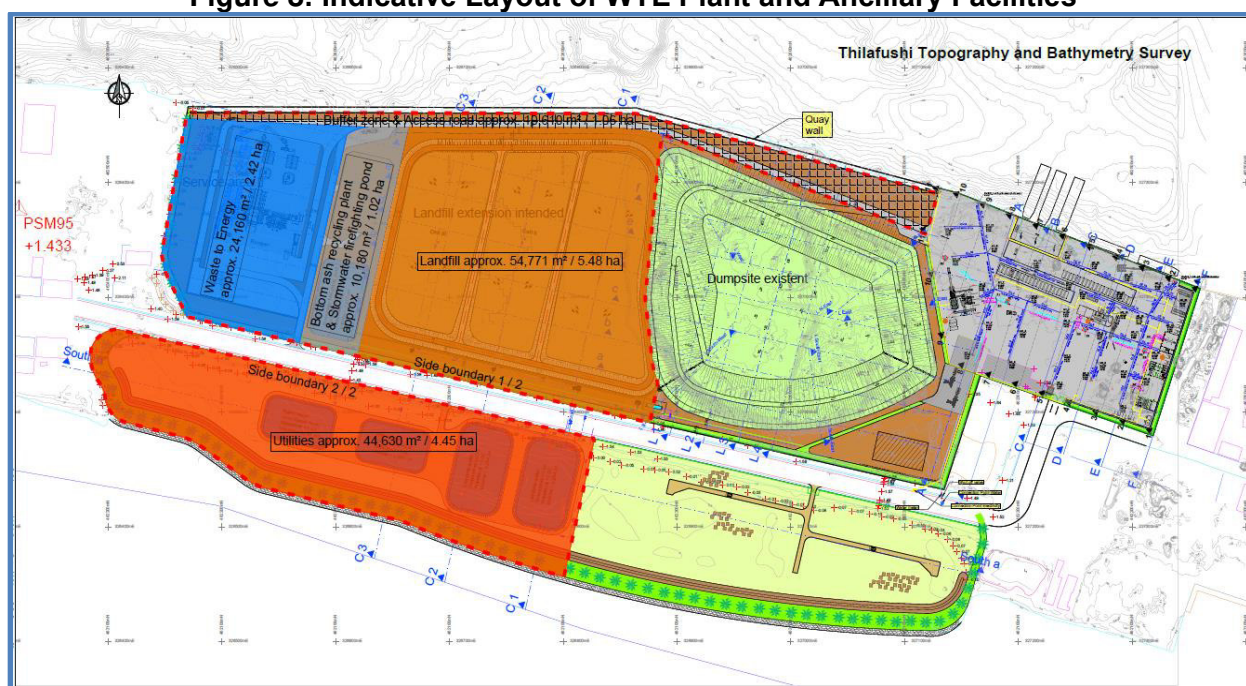
calculation. A larger footprint requirement at the RWMF at Thilafushi is due to the additional land required for the berth area.

138. The unit footprint requirement of the RWMF is comparable with other overseas incineration plants, including:

- (i) The Afval Energie Bedrijf (AEB) Incineration Plant with design capacity of 4,000 TPD in the Netherlands;
- (ii) The RWMF at the Tsang Tsui Ash Lagoons site with a design capacity of 3,000 TPD in Hong Kong; and
- (iii) The Tokyo Edogawa Incineration Plant with design capacity of 600 TPD in Japan.

139. Based on the layout of existing overseas installations, the footprint requirement for treating per tonnage of MSW daily is normally in the range of 30m<sup>2</sup> to 40m<sup>2</sup>. Figure 8 below shows the indicative layout arrangement of the WTE Plant and ancillary facilities.

**Figure 8: Indicative Layout of WTE Plant and Ancillary Facilities**



#### **D. Bottom Ash Reuse and Disposal**

140. The primary residual wastes from the WTE Plant are the incinerator bottom ash, slag and the residues from flue gas cleaning. The bottom ash may be used as raw material in the general construction industry. Because of the land area constraints in the Maldives, the DBO Contractor shall process bottom ash to marketable products to the highest possible extent and thus shall minimize the volume of waste from the incineration process to be disposed of in the residue landfill.

141. From the commissioned study on the reuse of treated bottom ash, there is a considerable potential to use treated bottom ash as aggregate for non-structural concrete. The processed bottom ash and recovered metals will be marketed and sold by WAMCO.

## E. Construction Schedule

142. The tentative construction schedule for the WTE plant is shown in Table 7. The conceptual design of the facility as per feasibility study level and the Employer's requirements has been developed. It is currently anticipated that the Request for Proposals will be issued in Q3 of 2019. The bid preparation period will be 5 months. The design and commissioning period includes all necessary permitting applications and the relevant approvals. Permitting is expected to last 6 months. Contract award is scheduled by mid-2020 and commissioning of the works by mid-2023.

**Table 7: Construction Schedule of the WTE plant**

	2019				2020				2021				2022				2023			
	Q1	Q2	Q3	Q4	Q1	Q2	Q3	Q4	Q1	Q2	Q3	Q4	Q1	Q2	Q3	Q4	Q1	Q2	Q3	Q4
Prequalification	■																			
Shortlisting		■																		
Request for proposals			■	■																
Evaluation and contract award					■	■	■	■												
WtE/balance of plant design+construction									■	■	■	■	■	■	■	■	■	■	■	■
Commissioning WtE																				■

## III. POLICY, LEGAL AND ADMINISTRATIVE FRAMEWORK

### F. ADB Safeguard Policy Statement

#### 1. Screening and categorization

143. The nature of the environmental assessment required for a project depends on the significance of its environmental impacts, which are related to the type and location of the project; the sensitivity, scale, nature, and magnitude of its potential impacts; and the availability of cost-effective mitigation measures. Projects are screened for their expected environmental impacts, and are assigned to one of the following four categories:

- (i) **Category A.** A proposed project is classified as category A if it is likely to have significant adverse environmental impacts that are irreversible, diverse, or unprecedented. These impacts may affect an area larger than the sites or facilities subject to physical works. An environmental impact assessment (EIA) is required;
- (ii) **Category B.** A proposed project is classified as category B if its potential adverse environmental impacts are less adverse than those of category A projects. These impacts are site-specific, few if any of them are irreversible, and in most cases mitigation measures can be designed more readily than for category A projects. An IEE is required;
- (iii) **Category C.** A proposed project is classified as category C if it is likely to have minimal or no adverse environmental impacts. No environmental assessment is required although environmental implications need to be reviewed; and
- (iv) **Category FI.** A proposed project is classified as category FI if it involves investment of ADB funds to or through a financial intermediary (FI). The FI must apply an environmental management system, unless all projects will result in insignificant impacts.

#### 2. Environmental Management Plan

144. An environmental management plan (EMP), which addresses the potential impacts and risks identified by the environmental assessment, shall be prepared. The level of detail and

complexity of the EMP and the priority of the identified measures and actions will be commensurate with the project's impact and risks.

### **3. Public disclosure**

145. ADB will post the following safeguard documents on its website so affected people, other stakeholders, and the general public can provide meaningful inputs into the project design and implementation<sup>26</sup>:

- (i) for Environmental Category A projects, a draft EIA report at least 120 days before Board consideration;
- (ii) final or updated EIA and/or IEE upon receipt; and
- (iii) environmental monitoring reports submitted by the project management unit (PMU) during project implementation upon receipt.

### **4. Pollution Prevention and Control Technologies**

146. During the design, construction, and operation of the project the PMU through the DBO Contractor will apply pollution prevention and control technologies and practices consistent with international good practice, as reflected in internationally recognized standards such as the World Bank Group's Environment, Health and Safety Guidelines, and Annex VI of Directive 2010/75/EU of the European Parliament and the Council. These standards contain performance levels and measures that are normally acceptable and applicable to projects. When the Government of Maldives regulations differ from these levels and measures, the executing agency will achieve whichever is more stringent. If less stringent levels or measures are appropriate in view of specific project circumstances, the executing agency will provide full and detailed justification for any proposed alternatives that are consistent with the requirements presented in ADB SPS 2009.

## **G. National Environmental Impact Assessment Law and Regulation**

147. Responsibilities and procedures for conducting environmental assessments, together with the requirements for environmental monitoring of projects, are set out in the EIA Regulations of 2012. All projects that may have an impact on the environment are referred to the Maldives EPA.

148. The EIA Regulations assign primary responsibility for undertaking environmental assessment of projects to the project proponent and set out procedures, rights and responsibilities for the preparation and approval of EIAs. The Maldives EPA undertakes review and approval of environmental assessment reports.

149. Project proponent is defined in the EIA regulations as a person, department or agency that is seeking to carry out or proposing to carry out development projects. The EIA regulations include a schedule (Schedule D) of investment project types that require an EIA. Examples of these projects are waste management projects such as landfills, waste incinerators and large-scale waste storage projects. Therefore, the WTE plant project that is subject of this EIA also requires an approval of the EIA by the Government of Maldives, through the Maldives EPA.

---

<sup>26</sup> As per ADB SPS, 2009, prior to disclosure on ADB website, ADB reviews the "borrower's/client's social and environmental assessment and plans to ensure that safeguard measures are in place to avoid, wherever possible, and minimize, mitigate, and compensate for adverse social and environmental impacts in compliance with ADB's safeguard policy principles and Safeguard Requirements 1-4."

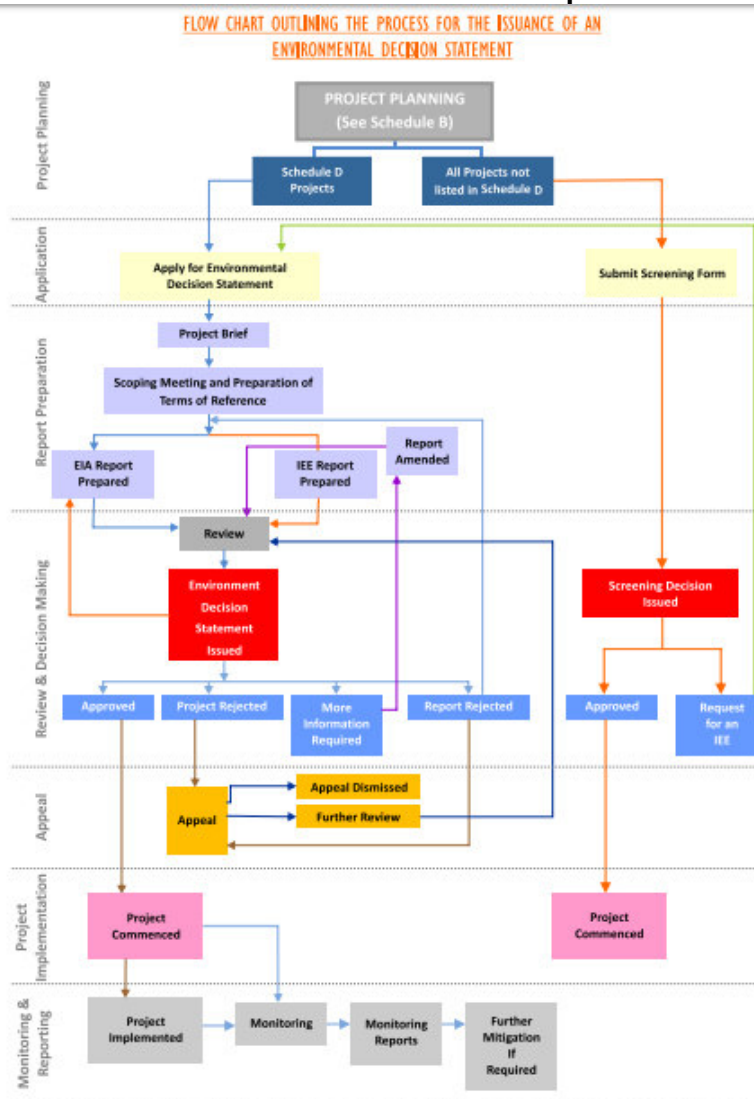
150. The EMP, following the EIA process, is prepared on a specified format and reviewed for compliance by Maldives EPA.

151. The Maldives EPA issues the decision in the form of a decision note issued to the proponent, which sets out specific binding requirements for the conduct of the project on the basis of review of the EIA report.

1. 152. Summary of application stages and steps is outlined in

Figure 9 below.

**Figure 9: Flow Chart of Maldives Environmental Impact Assessment Process<sup>27</sup>**



## H. Issuance of Environmental Decision Statement under the National EIA Law

153. The timelines for clearance and approvals are as follows:

- (i) On completion of a screening form for non-schedule D projects – 10 working days for a screening decision from Maldives EPA;
- (ii) For review of compliance of an EMP by Maldives EPA – 7 working days;
- (iii) For review of a project brief on Schedule D projects – 5 days to confirm the date of a scoping meeting;
- (iv) For consideration of Terms of Reference drafted by the project proponent following the scoping meeting – 10 days to confirm the Terms of Reference;
- (v) For the review of a completed EIA report for completeness – 2 working days;
- (vi) For circulation of an EIA report to other ministries and to the public for comment – 10 working days; and

<sup>27</sup> Source: Environmental Assessment Regulations (2007), Schedule A.

- (vii) For issuance of a decision or to request revisions, following circulation of the EIA report and receipt of comments – 28 working days.

## I. Applicable Environmental Standards

154. The government of Maldives does not have regulations on emission standards for Waste-to-Energy (WTE) facilities or any other similar infrastructure projects. Following requirements of ADB SPS, the project shall apply pollution prevention and control technologies and practices consistent with international good practices. While the project will be awarded under a DBO contract, preliminary design has been prepared following the European Union (EU) standards and practices. These preliminary designs are included in the draft DBO contract documents. Consistent with the basis of the preliminary design, the project will likewise comply with the applicable emission standards as indicated in the Directive 2010/75/EU of the European Parliament and the Council on industrial emissions (the EU Industrial Emissions Directive or EU IED). Table 8 below shows the standards that will be followed by the project as lifted from the EU IED. If less stringent levels or measures are appropriate in view of practicality or specific project circumstances, the government of Maldives will provide full and detailed justification for any proposed alternatives that are consistent with the requirements presented in ADB SPS.

**Table 8: Applicable Emission Standards for the Project**

Parameter	Averaging Time	Applicable to the Project (EU IED <sup>a</sup> )
Total Suspended particulates (PM <sub>10</sub> ), mg/m <sup>3</sup>	24 – hour	10
Sulfur Dioxide (SO <sub>2</sub> ), mg/m <sup>3</sup>	24 – hour	50
Oxides of Nitrogen (NO <sub>x</sub> ), mg/m <sup>3</sup>	24 – hour	200 – 400
Hydrochloric Acid (HCl), mg/m <sup>3</sup>		10
Dioxins and furans, ng TEQ/m <sup>3</sup>	6 – 8 - hour	0.1
Cadmium, mg/m <sup>3</sup>	0.5 – 8 - hour	0.05 – 0.1
Carbon Monoxide (CO), mg/m <sup>3</sup>		50 – 150
Mercury (Hg), mg/m <sup>3</sup>	0.5 – 8 - hour	0.05 – 0.1
Hydrogen Fluoride (HF), mg/m <sup>3</sup>		1
Sum of heavy metals and their compounds as Antimony, Arsenic, Lead, Chromium, Cobalt, Copper, Manganese, Nickel, Vanadium, Tin, Zinc, mg/m <sup>3</sup>	Between 30 min. and 120 min.	0.5
Cadmium/Thallium and compounds expressed as Thallium/Cadmium, mg/m <sup>3</sup>	Between 30 min. and 120 min.	0.05
Arsenic/Cadmium and their compounds (As and Cd), Benz(a)pyrene, water soluble Cobalt compound (as Co), Cr(Vi) compounds as Cr, mg/m <sup>3</sup>	Between 30 min. and 120 min.	0.05

<sup>a</sup> All values are related to 11% oxygen.

155. Similarly, the project shall monitor the ambient air quality and noise levels around the project sites during construction and operation phases. Sampling locations and the baseline information over which results will be compared are discussed in this EIA report. If less stringent levels or measures are appropriate in view of practicality or specific project circumstances, the government of Maldives will provide full and detailed justification for any proposed alternatives that are consistent with the requirements presented in ADB SPS. Table 9 and Table 10 below show the applicable ambient air quality standards and noise level standards to be followed under the project.

**Table 9: Applicable Ambient Air Quality Standards for the Project**

Parameter	Maldives Ambient Air Quality Standard ( $\mu\text{g}/\text{m}^3$ ) <sup>a</sup>	Averaging Time	WHO Air Quality Guidelines ( $\mu\text{g}/\text{m}^3$ ) Global Update <sup>b</sup> 2005	Applicable Per ADB SPS <sup>c</sup> ( $\mu\text{g}/\text{m}^3$ )
PM <sub>10</sub> , $\mu\text{g}/\text{m}^3$	-	24 – hour	50	50
PM <sub>10</sub> , $\mu\text{g}/\text{m}^3$	-	1 – year	20	20
PM <sub>2.5</sub> , $\mu\text{g}/\text{m}^3$	-	24 – hour	25	25
PM <sub>2.5</sub> , $\mu\text{g}/\text{m}^3$	-	1 – year	10	10
SO <sub>2</sub> , $\mu\text{g}/\text{m}^3$	-	10 – min	500	500
SO <sub>2</sub> , $\mu\text{g}/\text{m}^3$	-	24 – hour	20	20
NO <sub>2</sub> , $\mu\text{g}/\text{m}^3$	-	1 – hour	200	200
NO <sub>2</sub> , $\mu\text{g}/\text{m}^3$	-	1 – year	40	40
Ozone (O <sub>3</sub> ), $\mu\text{g}/\text{m}^3$	-	8 – hour	100	100

<sup>a</sup> Maldives currently does not have national ambient air quality standards set.

<sup>b</sup> WHO Air quality guidelines for particulate matter, ozone, nitrogen dioxide and sulfur dioxide. *Global update 2005*. WHO. 2006

<sup>c</sup> Per ADB SPS, the government shall achieve whichever of the ambient air quality standards is more stringent. If less stringent levels or measures are appropriate in view of specific project circumstances, the executing agency of the government will provide full and detailed justification for any proposed alternatives that are consistent with the requirements presented in ADB SPS.

**Table 10: Applicable Ambient Noise Level Standards for the Project**

Receptor/ Source	Maldives National Noise Level Standards <sup>a</sup> (dBA)		WHO Guidelines Value For Noise Levels Measured Out of Doors <sup>b</sup> (One Hour LA <sub>q</sub> in dBA)		Applicable Per ADB SPS <sup>c</sup> (dBA)	
	Day	Night	07:00 – 22:00	22:00 – 07:00	Day time	Night time
	Residential, institutional, educational	-	-	55	45	55
Industrial, commercial	-	-	70	70	70	70

<sup>a</sup> Maldives currently does not have noise level standards.

<sup>b</sup> Guidelines for Community Noise. WHO. 1999

<sup>c</sup> Per ADB SPS, the government shall achieve whichever of the ambient air quality standards is more stringent. If less stringent levels or measures are appropriate in view of specific project circumstances, the executing agency of the government will provide full and detailed justification for any proposed alternatives that are consistent with the requirements presented in ADB SPS.

156. In view of the need to provide safe drinking water to its workers during construction and operation phase, the project will ensure that drinking water made available complies with the applicable drinking water quality standards. Table 11 below shows the standards to be followed under the project.

**Table 11: Applicable Drinking Water Quality Standards for the Project**

Group	National Standards for Drinking Water <sup>a</sup>			WHO Guidelines for Drinking-Water Quality, 4th Edition, 2011 <sup>b</sup>	Applicable Per ADB SPS <sup>c</sup>
	Parameter	Unit	Standard		
Physical	Turbidity	NTU	<1	-	<1
	pH		6.5 to 8.5	none	6.5 – 8.5
	Color		Clear and	none	Clear and



Group	National Standards for Drinking Water <sup>a</sup>			WHO Guidelines for Drinking-Water Quality, 4th Edition, 2011 <sup>b</sup>	Applicable Per ADB SPS <sup>c</sup>
	Parameter	Unit	Standard		
			colorless		colorless
	Taste and Odor		-	-	-
	Electrical conductivity	µs/cm	<1,000	-	<1,000
	TDS	mg/l	<500	-	<500
	Suspended Solids	mg/l	5 – 750	-	5 – 750
Chemical	Iron	mg/l	<0.3	-	<0.3
	Manganese	mg/l	0.1	-	0.1
	Arsenic	mg/l	<0.01	0.01	<0.01
	Boron	mg/l	<0.3	-	<0.3
	Bromine	mg/l	0.05 – 4.50	-	0.05 – 4.50
	Cadmium	mg/l	<0.003	0.003	<0.003
	Chromium	mg/l	<0.05	0.05	<0.05
	Cyanide	mg/l	<0.07	-	<0.07
	Fluoride	mg/l	<1.5	1.5	<1.5
	Hydrogen Sulfide	mg/l	0.05	-	0.05
	Lead	mg/l	<0.01	0.01	<0.01
	Phosphate	mg/l	<5	-	<5
	Potassium	mg/l	0 - 50	-	0 - 50
	Ammonia	mg/l	<0.02 – 2.50	none established	<0.02 – 2.50
	Chloride	mg/l	<200	none established	<200
	Sulphate	mg/l	<250	none	<250
	Nitrate	mg/l	<50	50	<50
	Copper	mg/l	<2.0	2	<2.0
	Total Hardness	mg/l	<75	-	<75
	Calcium Hardness	mg/l	<60	-	<60
	Mercury	mg/l	<0.001	0.006	<0.001
	Free Chlorine	mg/l	0.04 – 0.2	-	0.04 – 0.2
	Anionic detergents	mg/l	0.002 – 0.275	-	0.002 – 0.275
	Phenolic compounds	mg/l	0.002 – 0.2	-	0.002 – 0.2
	Sodium	mg/l	<200	-	<200
	Total petroleum hydrocarbon	mg/l	0	-	0
Microbiological	Total coliform	Counts per 100ml CFU	0	-	0
	Fecal coliform	Counts per 100ml CFU	0	-	0
	Enterococci	Counts per 100ml CFU	0	-	0
	Salmonella Typhi	Counts per 100ml CFU	0	-	0

Group	National Standards for Drinking Water <sup>a</sup>			WHO Guidelines for Drinking-Water Quality, 4th Edition, 2011 <sup>b</sup>	Applicable Per ADB SPS <sup>c</sup>
	Parameter	Unit	Standard		
	Shigella spp.	Counts per 100ml CFU	0	-	0
Vibrio Cholerae	Counts per 100ml CFU	0	-	0	

<sup>a</sup> Maldives Environmental Protection Agency Supply Quality Standard

<sup>b</sup> Health-based guideline values.

<sup>c</sup> Per ADB SPS, the government shall achieve whichever of the ambient air quality standards is more stringent. If less stringent levels or measures are appropriate in view of specific project circumstances, the executing agency of the government will provide full and detailed justification for any proposed alternatives that are consistent with the requirements presented in ADB SPS.

157. For any wastewater generated and discharged during construction and operation phases, the project will ensure that the effluent will comply with the effluent standards as shown in Table 12 and Table 13 below, or other set of standards that may be stricter than the standards set in these tables and confirmed by the Maldives EPA.

**Table 12: The maximum permissible concentrations of pollutants discharged from the WTE leachate treatment plant into the environment**

Parameters		unit	Limit
Chemical Oxygen demand	COD	mg/l	200
Biological Oxygen demand	BOD <sub>5</sub>	mg/l	20
Total Inorganic Nitrogen	N <sub>tot, inorg</sub>	mg/l	70
Nitrite	NO <sub>2</sub> -N	mg/l	2
Sulfide	S	mg/l	1
Total Phosphate	P <sub>tot</sub>	mg/l	3
Lead	Pb	mg/l	0.5
Cadmium	Cd	mg/l	0.05
Total Chromium	Cr	mg/l	0.5
Chromium (VI)	Cr VI	mg/l	0.1
Mercury (total)	Hg	mg/l	0.02
Nickel	Ni	mg/l	1
Zinc	Zn	mg/l	2
Copper	Cu	mg/l	0.5
Arsenic	As	mg/l	0.1
Conductivity at 25°C*	-	μS/ cm	2,500

\*used to monitor the performance of the leachate treatment plant only

**Table 13: The maximum permissible concentrations of pollutants discharged from the WTE wastewater treatment plant into the environment**

<b>Parameters</b>		<b>unit</b>	<b>Threshold Value</b>
Chemical Oxygen demand	COD	mg/l	150
Biological Oxygen demand	BOD <sub>5</sub>	mg/l	40
Suspended Solids	-	mg/l	100
Ammonia-N	NH <sub>4</sub>	mg/l	15
Total N	N	mg/l	30
N-hexane extract (mineral oils, grease)	-	mg/l	10

## J. Other Relevant National Laws and Regulations

Name of Legislation	Area	Relevant to the Project?	Details
Environmental Protection and Preservation Act (1993, Law 4/93)	Generally covering the Environment	Yes	<p>Clause 5a states that an impact assessment study shall be submitted to the Ministry of Environment and Energy, Energy and Water before implementing any development project that may have a potentially detrimental impact on the environment. Therefore, Clause 5 is of specific relevance to this EIA. The EIA Regulation (2012), which came into force in May 2012 has been developed by the powers vested by the Environmental Protection and Preservation Act (1993).</p> <p>This EIA has also been prepared accordance with the guidance provided in the EIA Regulations (2012/R-27). This EIA will follow the environmental management aspects stated in the Environment Act 4/93 by ensuring that the Environmental Management Plan and proposed mitigation measures will enable the project from incurring any undesirable impacts on the environment.</p>
EIA Regulation (2012/R-27)	Environment	Yes	<p>The EIA Regulation (2012/R-27) guides the process of undertaking the EIA in the Maldives. The regulation provides detailed guidelines outlining the EIA process, including the roles and responsibilities of consultant and the proponent. It outlines every step of the EIA process beginning from EIA application to undertaking an EIA, it details the contents, minimum requirements for consultants undertaking the EIA, format of the EIA/IEE report. The Ministry of Environment and Energy has issued 3 amendments to this regulation over the past years, as follows:</p> <p>Amendment 1 (issued on 9th April 2013) covers the fines for proponents who fail to obey the regulation 2012/R-27.</p> <p>Amendment 2 (issued on 30th August 2015) covers the EIA report review criteria and review fees. This amendment also includes the latest update to the list of the projects that require EIA and the latest update to the list of the projects that do not require EIA.</p> <p>Amendment 3 (issued on 11th August 2016) covers the point systems for consultants, categories of the consultants and amendment of the penalties to consultants and proponents who fail to follow the regulation.</p> <p>This EIA is prepared in order to comply with the EIA Regulation (2012/R-27), as the regulation specifies the need for EIA clearance for waste management projects before the commencement of physical work. The guidance provided in this Regulation and its amendments</p>

			was followed in the preparation of this EIA report. The EIA has also been prepared by registered EIA consultants at Maldives EPA.
Waste Management Regulations (2013/R-58)	Environment	Yes	<p>The Ministry of Environment and Energy implements a Waste Management Regulation to minimize the impact of waste on the natural environment of the Maldives. The purpose of this regulation is to implement national policies regarding waste management. In this regard this regulation shall implement these policies to conserve the environment by: minimizing the direct and indirect negative impact caused to human health and the environment due to waste; compiling the standards to be maintained in relation to waste management; establishing an environmentally friendly, safe and sustainable waste management system through an integrated waste management structure; encouraging the public to minimize, reuse, recycle and recover waste; implementing the “polluter pays” principle and introducing extended producer responsibility.</p> <p>This project will conform to this law. The waste produced from the initial site preparation works will be managed according to the waste regulation. The waste generated from the project site will be temporarily stored in a designated area and will be transported to the Thilafushi waste management area for final treatment and disposal.</p>
Protected and Sensitive Areas	Environment	Yes	<p>Under Article 4 of the Environment Protection and Preservation Act, the Ministry of Environment and Energy has vested responsibility for identifying and registering protected areas and natural reserves and for drawing up of rules and regulations for their protection and preservation.</p> <p>As part of the Environmental Regulation, the Maldives EPA has established a list of ‘sensitive sites’ in the Maldives. Although not formalized as a regulation, the list is mentioned in the Regulation on Dredging and Reclamation (Regulation number 2014/R-13, see Section 5.7, page34). The sensitive sites, according to the Maldives EPA, are sites in the Maldives (islands, reefs, mangroves, inter-tidal areas) where developments ought to be restricted, regulated or controlled.</p> <p>This project does not fall to a boundary of a protected area or an area on the Maldives EPA list of ‘sensitive sites’. However, there are MPAs within 10km radius of the project site. These sites are detailed in the existing environment section of the EIA report.</p>
Environmental Liability Regulation (on 2011/R-9)	Environment	Yes	The Environmental Liability Regulation covers a wide range of issues which enable charging of penalties and providing compensation by polluters in accordance with the Maldives EPA. The regulation came into effect in order to ensure that any developmental activities

			<p>conducted will ensure the protection of the environment as well as sustainable development. The regulation also ensures that the surrounding environment is not degraded or deteriorated, and any natural resources are not wasted during said developmental activities. The project activities will be carried out according to the Environment Management Plan with proposed mitigation measures to ensure that the proposed project complies with the Environmental Liability Regulation. Since the EIA forms an integral part of the civil works and operations contracts, the respective parties shall be aware that Environmental Liability Regulation will be applied in instances where damage to the environment is caused.</p>
<b>Guidelines &amp; Action Plans</b>			
Post EIA Monitoring, Auditing and Evaluation	Environment	Yes	<p>The environmental monitoring program has been recommended in the EIA. The monitoring program outlines the objectives of the monitoring; the specific information to be collected; the data collection program and managing the monitoring program. Managing the monitoring program requires assigning institutional responsibility, reporting requirements, enforcement capability, and ensuring that adequate resources are provided in terms of funds, skilled staff, etc.</p> <p>The environmental monitoring program outlined in this report has been developed to comply with the EIA Regulations 2012/R-27.</p>
Waste Incineration Guidelines (Draft 2019)	Environment, Waste Management	Yes (but the guideline is still in draft stage)	<p>This guideline has been drafted by the Environmental Protection Agency (EPA) of the Maldives to facilitate the construction and operation of waste incinerators safely and to mitigate the adverse environmental and health impacts that may arise. This guideline applies to all kinds of waste incinerators and will assist the managers and operators. The guideline discusses four main components (Site selection, emission control, wastewater management and waste management) for the environmental considerations.</p> <p>The site selection for waste incinerators must be selected in a way that would not pose a threat to the surrounding environment and the local community. This guideline sets a minimum buffer distance of 60m from sensitive land uses such as residential use, schools and hospital. It also states that a minimum distance of 30m shall be kept between the vegetation line and the incinerator.</p> <p>The operator of the waste incineration facility must ensure that air emission levels are maintained below the values which is provided in the guidelines covering dust, VOC, HCl, HF, SO<sub>2</sub>, NO<sub>x</sub>, CO, Cd and Tl, Hg and Dioxins.</p>

			<p>The draft guideline states that Wastewater from the incinerator must be discharged according to the standards set by Maldives EPA.</p> <p>Management of general waste management in the waste incinerator facilities must follow the standards set by Waste Management Regulation 2013/R-58. The guideline sets the procedures for ash management (fly ash and bottom ash) as well as health and safety considerations, monitoring and control systems as well as contingency plans.</p>
National Water and Sewerage Policy (2017)	Environment	Yes	<p>The National Water and Sewerage Policy focuses on providing access to safe water and sewerage services for all. The NWSPP has 9 goals: ensure access to safe water supply and adequate sewerage services; adopting cost-effective, environment friendly and appropriate technologies; strengthening legal framework; encouraging private sector investments; building institutional capacity; maintaining financial and environmental sustainability; strengthening advocacy and awareness; promoting research and development; and protection and conservation of water resources. Policy objective 9: calls for adopting a holistic approach to water resources protection, conservation, management, and pollution control. Among the strategies for objective 9 are: establishing an effective research-based monitoring program and information platform for inhabited islands' water resources; developing and implementing evidence-based water resources management plans taking into consideration the sustainability and vulnerability of the island fresh water resources, wastewater reclamation, water reuse and minimization of impacts from pollution.</p>
National Biodiversity Strategy and Action Plan (2016)	Environment	Yes	<p>The National Biodiversity Strategy and Action Plan (NBSAP) 2016-2025 is a 10-year plan and is designed to address the following 6 broad areas of concern by setting a strategy with targets.</p> <p>Strategy 1 – Strengthen governance, policies and strategies for biodiversity</p> <p>Strategy 2 – Enhancing communication and outreach through awareness programs and capacity building</p> <p>Strategy 3 – Work together globally for biodiversity conservation</p> <p>Strategy 4 – Ensure sustainable use of biological resources</p> <p>Strategy 5 – Address threats to conserve biodiversity</p> <p>Strategy 6 – Strengthen information management and resource mobilization</p> <p>The 3 basic principles of the National Biodiversity Strategy and Action Plan 2016-2015 are</p>

			<p>The people of this generation and the generations to come reserves the right to access and share benefits of rich biodiversity and ecosystem service;</p> <p>Responsibility for conserving and sustainable using biodiversity lies on everyone's shoulders and shall be taken as a shared responsibility;</p> <p>Biodiversity shall be mainstreamed into all sectors and in a manner whereby monitoring progress and accountability ensured.</p> <p>The EIA report has considered the six strategies stipulated in the NBSAP. In implementing the proposed project activities, due care should be given to ensure that the national biodiversity strategies are adhered to. The proponent has committed to protection of the environment by minimizing the impact of the natural environment while undertaking the proposed project. More specifically, the coral reef and generally the marine environment have been assessed in order to provide baseline information. Quantitative and qualitative surveys were undertaken to assess the biological diversity of the marine environment, especially in close proximity to the proposed project area. Practical mitigation measures have been identified to protect the marine biodiversity around the proposed project area.</p>
Third National Environment Action Plan (2009)	Environment	Yes	<p>The Third National Environment Action Plan (NEAP 3) is divided into principles, outcomes and goals to achieve the results. Principles prescribed in NEAP 3, which have been incorporated into this EIA exercise include local democracy, informed decision making, continuous learning and improvement, the right to information and participation and most importantly the complementing role of environmental protection in socio-economic development. The proposed project is expected to provide a learning experience in terms of effectiveness of the use of EIA as a planning instrument and appropriate monitoring for which specific focus is laid in Objective 24.1 of NEAP 3 (Ministry of Housing, Transport and Environment, 2009). By undertaking EIA prior to developmental projects, it ensures that environmental impacts from the project activities are minimized or avoided. This project is aiming to address the national waste management issue by facilitating the establishment of Regional Waste Management Facility for Project area covering the islands in the central region of the Maldives.</p>
Maldives Climate Change Policy Framework (2015)	Climate change	Yes	<p>The Maldives Climate Change Policy is a framework to address the climate change issues in the Maldives. It aims to adopt and mitigate the current and future effects of climate change. The policy recognizes climate change as a central player in sustainable development. The</p>



			<p>policy is based on a set of principles to guide related activities that take into account national laws, national development plans, strategies, action plans, policies and relevant documents. The policy has been guided by eight principles: climate leadership, intergenerational equitability, mainstreaming climate change, relevant international commitments, multinational partnerships, transfer of technology and climate resiliency.</p> <p>The proposed project is an adaptation project to improve the resilience of the reef environment through better management of waste in the islands of the Maldives.</p>
Maldives Marine Monitoring Standards issued by EPA.	Marine water quality	Yes	This guideline would be used as a standard to measure the ambient condition to monitor the condition of the marine water quality against the established baseline.
Australian and New Zealand Guidelines for Fresh and Marine Water Quality	Sediments	For comparison purpose	Traces of heavy metals and organometallics in the marine sediments would be compared with the Australian and New Zealand Guidelines for Fresh and Marine Water Quality which quote maximum guideline concentrations for contaminants in freshwater and marine sediments for reference purpose. The traces of heavy metals in the sediments sampled in the post EIA monitoring activities will be compared with that of the baseline which has been established in the EIA process.
Permits			
EIA Decision Statement	Environment	Yes	In order to commence work on the project, the proponent requires to obtain the EIA Decision Statement issued by Maldives EPA following evaluation of this EIA. The EIA Decision Statement is prepared based on the information presented in this EIA report particularly the mitigation measures provided to prevent or reduce the potential environmental impacts. In addition, the monitoring requirements of the project are enforced in the EIA Decision Statement.
Dewatering Permit	Ground water	Yes	A dewatering permit is required for the project during excavation works. A separate application will have to be made to the Maldives EPA to get the permit. Permission can be granted for dewatering at a stretch for a maximum of 28 days, for which a sum of Rf500 should be paid per day. This amount is liable to be increased with the number of days increased.
Dredging and Reclamation Permit	Coastal modification	Yes	Prior to any coastal work that requires dredging or reclamation, a special permit has to be taken from the Maldives EPA. A specific form published by Maldives EPA has to be completed and submitted for the approval. EIA application form will only be accepted when the form is submitted with the coastal modification approval given by Maldives EPA in writing.

Registration of Desalination Plants	Desalination plant	Yes	According to Desalination Regulation of the Maldives, all desalination plants operating in the Maldives catering for public water supplies and commercial purposes would have to be registered with Maldives Environmental Protection Agency (EPA) former Maldives Water and Sanitation Authority (MWSA). Therefore, the desalination plants to be installed for the project would have to be registered with Maldives EPA. For this, the Proponent will be required to submit the EIA Decision Note for this EIA report, completed application forms with all details of the plant to be registered. A copy of the relevant section of this EIA may be appended to the forms as justification for the desalination plants.
-------------------------------------	--------------------	-----	---

## K. Applicable International Environmental Agreements

158. In addition to national laws, rules and regulations, the government of Maldives is also a signatory to various applicable international conventions. Those applicable to the project as a waste facility in a coastal area, are those relating to environmental pollution and biosafety, as follows:

- (i) International Convention for the Prevention of Pollution of the Sea by Oil (1982);
- (ii) Vienna Convention for the Protection of the Ozone Layer (1985);
- (iii) Montreal Protocol on Substances that Deplete the Ozone Layer (1987);
- (iv) Basel Convention on the Control of Transboundary Movement of Hazardous Wastes and their Disposal (1989);
- (v) The London Amendment to the Montreal Protocol on Substances that Deplete the Ozone Layer (1990);
- (vi) Convention on Biological Diversity (1992);
- (vii) United Nations Framework Convention on Climate Change (1992);
- (viii) The Copenhagen Amendment to the Montreal Protocol on Substances that Deplete the Ozone Layer (1992);
- (ix) The Montreal Amendment to the Montreal Protocol on Substances that Deplete the Ozone Layer (1997);
- (x) The Beijing Amendment to the Montreal Protocol on Substances that Deplete the Ozone Layer (1999);
- (xi) Washington Declaration on Protection of the Marine Environment from Land-Based Activities;
- (xii) Kyoto Protocol to the United Nations Framework Convention on Climate Change (1998); and
- (xiii) Cartagena Protocol on Biosafety (Maldives acceded on 2 September 2002).

## IV. ANALYSIS OF ALTERNATIVES

159. ADB SPS requires projects with potential significant adverse environmental impacts to undertake analysis of alternatives. This step will ensure all reasonable alternatives or options are taken into account, including the effect of a no project option scenario, and that these are examined with an eye towards minimizing impacts to the environment and allowing decision makers to choose the best alternatives to protect and enhance environmental quality. Alternatives include project redesign, alternative sites, and alternative technologies and construction techniques.

160. This section presents all the alternatives considered under the project that led to the selection of design as discussed in Section III. As the project will be implemented under a DBO arrangement, specific details of project components are expected to be decided upon by the contractor during the detailed design stage. However, alternatives assessed and recommended or selected in this EIA shall be used and will be made binding to the contractor through relevant provisions in the DBO contract documents.

### A. No Project Option

161. It should be noted that the **“no project” option** cannot be excluded without proper evaluation. In this report this alternative was considered as the baseline against which to evaluate the other options. The no project option takes the following into consideration:

- (i) Continue current dumping of waste as a method to manage waste in Thilafushi;
- (ii) Cost related to the project activities will be avoided;
- (iii) Further environmental damage to the proposed area will be avoided; and
- (iv) Existing public frustration will continue to worsen due to lack of proper waste management system in Thilafushi.

162. The main advantages and disadvantages of the no-project option are given in **Table 14**.

**Table 14: Advantages and disadvantages of the no project option**

<b>Strategy</b>	<b>Advantages</b>	<b>Disadvantages</b>
Carrying out the waste management practice in Thilafushi without establishment of a Regional Waste Management Facility for Project area	Costs related to improving the situation may be avoided in the short term.  Environmental problems related to development can be avoided	Long term social problems may arise due to unacceptable manner of waste management in the island.  Higher long-term costs to fix and maintain the existing waste dump site in Thilafushi, especially if the island will continue to accept and manage wastes generated in Project area.
Improving waste management using existing land in Thilafushi	Short term costs associated with the project may be avoided	Existing site does not have infrastructure to develop a proper waste management and disposal facility.  The existing problems for the management of waste may worsen.  Option will not address current concerns adequately, and public frustrations and anger may prevail in time.

163. In view of the current status of the waste issue in Thilafushi, it is evident that the waste management practice in the island needs urgent actions. The small islands in Project area are now suffering from serious environmental and human health impacts due to inefficient waste disposal system. Apart from being a priority of the government, the option to develop a better waste management system in Project area is highly justified in order to address the worsening waste management scheme in the region, more particularly in the small island communities. On this basis, the positive benefits of establishing a proper waste management facility that will cater to the atolls or islands in the central region of the Maldives clearly outweighs the financial, environmental and social implications. Therefore, the “no project” option is not recommended.

164. According to the findings and recommendations of the site selection and technology selection processes, including the construction and operation requirements, the scope of the project in Thilafushi has been developed. It should be noted that in addition to the consideration of alternative site and technology for the development of the WTE Plant, the following alternatives have been considered in the study in arriving at the preferred scope of the project.

## **B. Alternative Options for the Management of Waste**

165. Feasibility Study for an Integrated Solid Waste Management System for Project area (including Greater Malé) and Design of the Regional Waste Management Facility at Thilafushi (2018) for selection of the most appropriate waste management option has been conducted using a screening and selection process known as the Best Practicable Environmental Option (BPEO).

166. BPEO entails a systematic and balanced assessment of different waste disposal options, to identify the option which provides maximum environment, economic and social benefit. A BPEO process involves a process of identifying viable scenarios for waste management, followed by a process of performance assessing against a number of decision criteria such as technical, environment, social and financial/economic to determine which scenario is the preferred option. The BPEO concept has been outlined in the “National Solid Waste Management Policy for the Republic of Maldives” and has been identified as “one of the strategic principles for development of waste management systems in the country”.

167. BPEO is a strategic rather than site-specific tool, hence it does not address the site-specific issues associated with individual locations and it cannot justify the selection of particular site for individual facilities. The BPEO approach implicitly recognizes that the preferred option may differ from location to location because of variation in the local needs, resources and impact and in relative significance of criteria. Nevertheless, because of the nature of analysis required, the concept is not sufficiently precise to be used to justify the selection of specific sites, but is appropriate to use in conjunction with the broad area of research. The geographical, social and cultural context in the Maldives makes the search for options and scenarios more complex while due to its unicity there is not similar cases which could be transferred from other countries in the region.

**Figure 10: Levels of BPEO processes**



168. The first level is focused on the different treatment technologies in the SWM. Objective is to reduce the number of technologies to a reasonable level in order to develop a minimum number of scenarios through the BPEO process (3 level). Initially 8 options were developed in a series of consultative workshops with key stakeholders in the process of identifying and finalizing a BPEO for a technology that will be used in RWMP. The identified options included: windrow composting, in-vessel composting, Mechanical biological treatment (MBT), Bio-methanation, Refuse Derived Fuel (RDF), Incineration, Integrated system of composting with RDF, Integrated system of Sanitary landfill (of complete MSW).

169. The study (Financial Feasibility report for the RWMP; SENES & CDE 2011) for selection of the most appropriate waste management option has been conducted using a screening and selection process known as the Best Practicable Environmental Option (BPEO). BPEO entails a systematic and balanced assessment of different waste disposal options, to identify the option

which provides maximum environment, economic and social benefit. A BPEO process involves a process of identifying viable scenarios for waste management, followed by a process of performance assessing against a number of decision criteria such as technical, environment, social and financial/economic to determine which scenario is the preferred option.

170. A series of consultative workshops with key stakeholders were held in the process of identifying and finalizing a BPEO for a technology that will be used in RWMF and for selection of most appropriate site to locate this facility. The identified options were assessed against each decision criteria (environmental, technical, economic and social) during the BPEO exercise and the assessment resulted in three options, here ranked according to their initial priority:

- (i) Composting of organic waste at the island level, simple incineration of remaining waste and land reclamation with rejects at RWMF;
- (ii) Composting of organic waste at the island, transportation of rejects to RWMF for landfill; and
- (iii) Composting of organic waste at the island level, simple incineration of remaining waste and landfilling of rejects at RWMF.

171. The Incineration technology has been finally selected though the BPEO exercise.

## **C. Alternative Incineration Technologies**

### **1. Grate technology**

172. Grate incinerators are widely applied for the incineration of mixed municipal wastes and can be used for untreated, non- homogenous, and low calorific municipal waste. An overhead crane feeds waste into the hopper, where it is transported via the chute to the grate in the furnace. On the grate, the waste is dried and then burned at high temperature with supply of air. The ash, including non-combustible fractions of waste, leaves the grate as slag or bottom ash through the ash chute.

173. Different grate systems can be distinguished by the way the waste is conveyed through the different zones in the combustion chamber. The type of grate system determines the efficacy of primary air feeding, conveying velocity and raking, as well as mixing of the waste.

174. Reciprocating grates: Many modern MSWM incinerator facilities use reciprocating grates. The quality of burnout achieved is generally good. Reciprocating grates consist of sections that span the width of the furnace but are stacked above each other. Alternate grate sections slide back and forth, while the adjacent sections remain fixed. Waste tumbles off the fixed portion and is agitated and mixed as it moves along the grate.

175. There are essentially two main reciprocating grate variations:

- (i) Reverse reciprocating grate: The grate bars oscillate back and forth in the reverse direction to the flow of the waste. The grate is sloped from the feed end to the ash discharge end and is comprised of fixed and moving grate steps.
- (ii) Push forward grate: The grate bars form a series of many steps that oscillate horizontally and push the waste in the direction of the ash discharge. Other grate types that have been in use include rocking grates, travelling grates, roller grates, and cooled grates.

176. Grate incinerators are of two types:

- (i) Moving grate furnace system: waste enters from one end while ash is discharged at other
- (ii) Fixed grates: series of steps with drying stage and initial combustion phase, complete combustion and final carbon burn- out

177. Advantages of Grate Incinerators:

- (i) There is no need for prior sorting or shredding.
- (ii) Technology is widely tested and meets the standards of technical performance.
- (iii) It accommodates large variations in waste composition and calorific value.
- (iv) It allows for an overall thermal efficiency of up to 85%.

178. Disadvantage of grate incinerators:

- (i) Capital and maintenance costs are relatively high.

179. The viability of grate incinerators in the Maldives context is high. The advantages of this technology clearly fit to address the challenges being encountered in Maldives, particularly on the large variations in waste composition collected from sources that is very common in developing countries.

## 2. Pyrolysis

180. Pyrolysis involves an irreversible chemical change brought about by the action of heat in an atmosphere devoid of oxygen. Synonymous terms are thermal decomposition, destructive distillation, and carbonization. Pyrolysis, unlike incineration, is an endothermic reaction and heat must be applied to waste to distil volatile components. The converting of plastic to fuels through pyrolysis is possible, but it is yet to be proven to be a commercially viable venture.

181. Pyrolysis is carried out at 500°C – 1,000°C and produces three component streams:

- (i) Gas: a mixture of combustible gases such as hydrogen, carbon monoxide, methane, carbon dioxide, and some hydrocarbons.
- (ii) Liquid: consisting of tar, pitch, light oil, and low boiling organic chemicals like acetic acid, acetone, methanol, etc.
- (iii) Char: consisting of elemental carbon along with the inert material in the waste feed.

182. The gas and liquid fractions and the char are useful because of their high calorific value. Part of the heat obtained by combustion of either char or gas is often used as process heat for the endothermic pyrolysis reaction. It has been observed that even after utilizing the heat necessary for pyrolysis, extra heat still remains which can be commercially exploited.

183. Although a number of laboratory and pilot investigations have been made, only a few have led to full scale plants. German experience also indicates that while several small-scale pyrolysis and gasification plants for MSW were set up a few decades ago, almost all have been shut down due to operational and commercial issues.

184. **Feed stock for pyrolysis.** Feedstock for pyrolysis should have high calorific value with very limited moisture content and should be homogenous in nature. Many plastics, particularly

the polyolefins, which have high calorific values and simple chemical constitutions of primarily carbon and hydrogen, are usually used as a feedstock in pyrolysis. More recently, pyrolysis plants are being tested to degrade carbon-rich organic material such as MSW. For mixed MSW pre-processing is necessary to bring homogeneity to increase efficiency.

185. **Municipal solid waste pyrolysis.** Sorted and pre-treated feedstock is supplied to pyrolysis reactor-rotary kilns, rotary hearth furnaces, and fluidized bed furnaces which are commonly used as MSW pyrolysis reactors where partial combustion of material occurs at 500°C-800°C.

186. As a result of combustion of organic matter in an oxygen-deficient environment, various products such as char (ash), pyrolysis oil, and syngas are produced. Production of these is dependent on the organic component of MSW, temperature, pressure, and time of retention in the reactor. Char or solid residue is a combination of non-combustible material and carbon. The syngas is a mixture of gases (combustible constituents include carbon monoxide, hydrogen, methane, and a broad range of other volatile organic compounds). Syngas is further refined to remove particulates, hydrocarbons, and soluble matter, and is then combusted to generate electricity. The syngas typically has a net calorific value (NCV) of 2,800-4,800 kilocalories per normal cubic meter (kcal/Nm<sup>3</sup>) or 10 – 20 mega joules per normal cubic meter (MJ/Nm<sup>3</sup>). If required, the condensable fraction can be collected by cooling the syngas, potentially for use as a liquid fuel (oils, waxes, and tars).

187. One key issue for use of syngas in energy recovery is tarring. The deposition of tars can cause blockages and other operational challenges and has been associated with plant failures and inefficiencies at some pilot and commercial scale facilities. Tarring issues may be overcome by higher temperature secondary processing.

188. In order to recover the energy content of syngas, it should be further processed in the following ways:

- (i) Syngas can be burned in a boiler to generate steam, which may be used for power generation or industrial heating;
- (ii) Syngas can be used as a fuel in a dedicated gas engine;
- (iii) Syngas, after reforming, may be suitable for use in a gas turbine; and
- (iv) Syngas can also be used as a chemical feedstock.

189. For plasma pyrolysis of MSW, it should be noted that, along with pre-sorted MSW as feedstock, additional inputs, such as flux material and carbonaceous material (e.g. coke) are required.

190. **Plasma pyrolysis vitrification.** This is a modified pyrolysis technology aiming at energy or resource recovery from organic waste. The system uses a plasma reactor, which generates, by application of high voltage between two electrodes, an extremely high temperature (5,000°C-14,000°C). This hot plasma zone dissociates the molecules in any organic material into the individual elemental atoms, while all the inorganic materials are simultaneously melted into a molten lava. This process is still far away from any proven practical and sustainable application in MSWM.



### 3. Gasification

191. Gasification is a partial combustion of organic or fossil based carbonaceous material, plastics, etc. into carbon monoxide, hydrogen, carbon dioxide, and methane. This is achieved at high temperature (650°C and above), with a controlled amount of air, oxygen, or steam. The process is largely exothermic, but some heat may be required to initialize and sustain the gasification process.

192. The main product is syngas, which contains carbon monoxide, hydrogen, and methane. Typically, the gas generated from gasification will have an NCV of 4–10 MJ/Nm<sup>3</sup>. The other main product produced by gasification is a solid residue of non-combustible material (ash), which contains a relatively low level of carbon.

193. **Gasification of municipal solid waste.** Feedstock Preparation: MSW should be pre-processed before it can be used as feedstock for the gasification process. The pre-processing comprises of manual and mechanical sorting, grinding, blending with other material, drying, and pelletization. The purpose of pre-processing is to produce a feed material with consistent physical characteristics and chemical properties. Carbonaceous material of municipal waste stream is most important feedstock for gasification.

194. **Gasifiers for municipal solid waste treatment.** Gasification technology is selected on the basis of available fuel quality, capacity range, and gas quality conditions. The main reactors used for gasification of MSW are fixed beds and fluidized beds. Larger capacity gasifiers are preferable for treatment of MSW because they allow for variable fuel feed, uniform process temperatures due to highly turbulent flow through the bed, good interaction between gases and solids, and high levels of carbon conversion.

195. **Fixed Beds.** Fixed bed gasifiers typically have a grate to support the feed material and maintain a stationary reaction zone. They are relatively easy to design and operate, and are therefore useful for small and medium scale power and thermal energy uses. The two primary types of fixed bed gasifiers are updraft and downdraft.

196. In an updraft gasifier, the fuel is also fed at the top of the gasifier, but the airflow is in the upward direction. As the fuel flows downward through the vessel, it dries, pyrolyzes, gasifies, and combusts. The main use of updraft gasifiers has been with direct use of the gas in a closely coupled boiler or furnace. Because the gas leaves this gasifier at relatively low temperatures, the process has a high thermal efficiency and, as a result, wet MSW containing 50% moisture can be gasified without any pre-drying of the waste.

197. In a downdraft gasifier, air is introduced into a downward flowing packed bed or solid fuel stream and gas is drawn off at the bottom. The air or oxygen and fuel enter the reaction zone from the top, decomposing the combustion gases and burning most of the tars. Downdraft gasifiers are not ideal for waste treatment because they typically require a low ash fuel such as wood to avoid clogging.

198. **Fluidized Beds.** Fluidized beds are an attractive proposition for the gasification of MSW. In a fluidized bed boiler, a stream of gas (typically air or steam) is passed upward through a bed of solid fuel and material (such as coarse sand or limestone). The gas acts as the fluidizing medium and also provides the oxidant for combustion and tar cracking. Waste is introduced either on top of the bed through a feed chute or into the bed through an auger. Fluidized beds have the advantage of extremely good mixing and high heat transfer, resulting in very uniform bed

conditions and efficient reactions. Fluidized bed technology is more suitable for generators with capacities greater than 10 MW because it can be used with different fuels, requires relatively compact combustion chambers, and allows for good operational control. The two main types of fluidized beds for power generation are bubbling and circulating fluidized beds.

199. In a bubbling fluidized bed (BFB), the gas velocity must be high enough so that the solid particles, comprising the bed material, are lifted, thus expanding the bed and causing it to bubble like liquid. A bubbling fluidized bed reactor typically has a cylindrical or rectangular chamber designed so that contact between the gas and solids facilitates drying and size reduction (attrition). As waste is introduced into the bed, most of the organics vaporize pyrolytically and are partially combusted in the bed. Typical desired operating temperatures range from 900°C to 1,000°C.

200. A circulating fluidized bed (CFB) is differentiated from a bubbling fluid bed in that there is no distinct separation between the dense solids zone and the dilute solids zone. The capacity to process different feedstock with varying compositions and moisture contents is a major advantage in such systems.

201. **Integrated gasification with power generating equipment.** MSW gasification can be integrated with power turbines, steam cycle, and other power generating equipment to provide thermal energy. Combination of MSW gasification with power turbines and fuel cells increases overall efficiency of the system. Development is happening on the following lines:

- (i) Integrated gasification combined cycle (IGCC) is based on the concept of integrating MSW gasification with gas turbines and steam cycle.
- (ii) Fuel cells are integrated with MSW gasifier. Tubular solid oxide fuel cells have been found to be most effective for these applications.

202. **General challenges of operating gasification plants.** Gasification takes place in low oxygen environment that limits the emission of pollutants. It also generates fuel gas that can be further used in a number of ways, as suggested in the section on pyrolysis. During gasification, tars, heavy metals, halogens, and alkaline compounds are released within the product gas and can cause environmental and operational problems. Tars are high molecular weight organic gases that ruin reforming catalysts, sulfur removal systems, and ceramic filters and increase the occurrence of slagging in boilers, on other metal and refractory surfaces. Alkalis can increase agglomeration in fluidized beds that are used in some gasification systems and can also ruin gas turbines during combustion. Heavy metals are toxic and accumulate, if released into the environment. Halogens are corrosive and a cause of acid rain, if emitted to the environment. The key to achieving cost efficient, clean energy recovery from MSW gasification will be overcoming problems associated with the release and formation of these contaminants.

203. **Challenges of Utilizing Pyrolysis and Gasification Technologies in Maldives.** High calorific value waste, which may otherwise be processed in more sustainable processes, is required as feedstock. Organics can be converted into compost in a much more cost effective and environmentally safe process, as against using them as feedstock for these processes.

204. Pyrolysis and gasification processes require specific feedstock quality, which has a direct impact on the efficiency and commercial viability of the product. Pre-treatment of waste is a must for pyrolysis but is not practical in the context of Maldives as source separation has not been possible due many factors and on-site separation is not possible due to the unavailability of land at transfer stations proposed and at the Thilafushi RWMF. Specified size and consistency of solid

waste should be achieved before MSW can be used as feed. Therefore, pyrolysis and gasification processes are not viable options under the project.

#### **D. Alternatives on Discharge Locations for WTE Cooling Water**

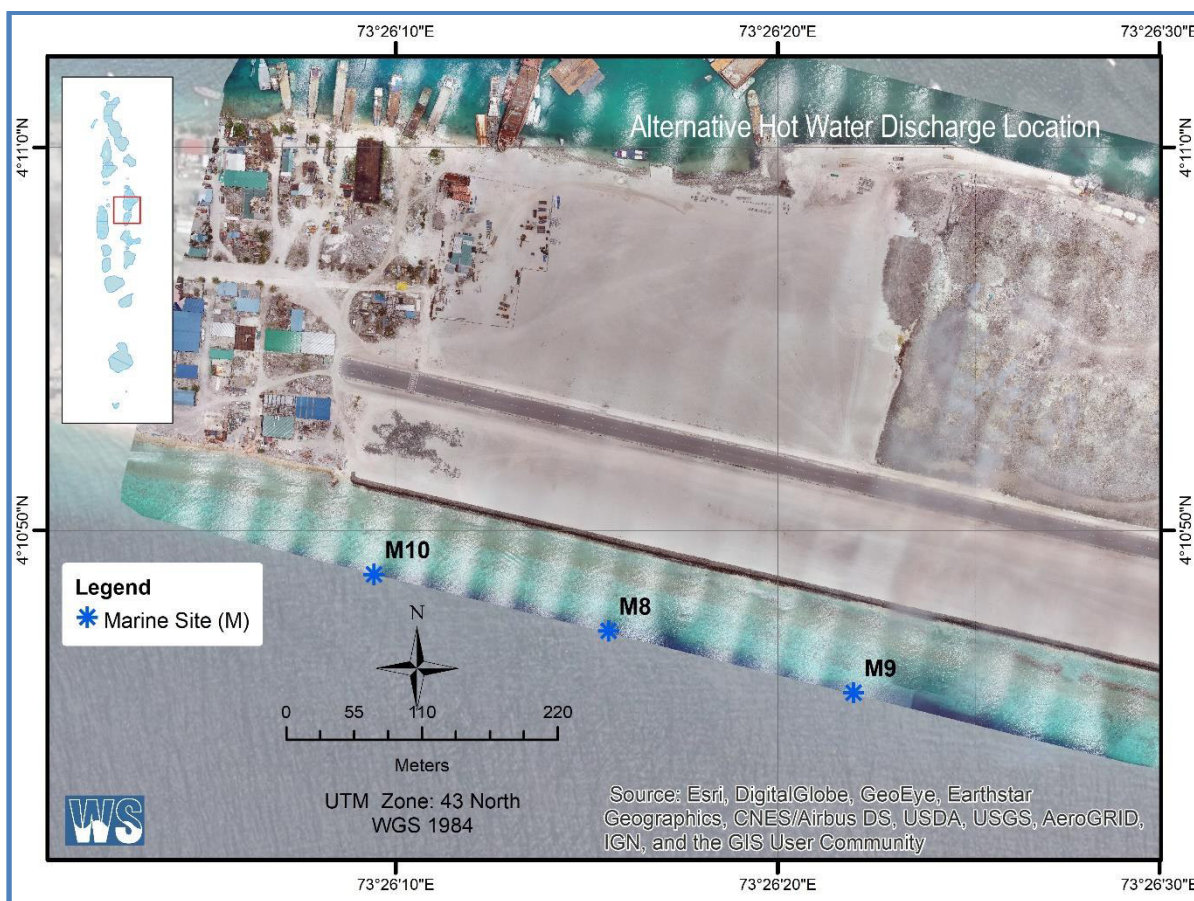
205. The proposed WTE plant will use sea water as the coolant and discharge cooling water back to the sea. Inevitably, the temperature of water discharged is above the ambient. As temperature is one of the most important environmental variables, discharging water of elevated temperature will have significant impact to aquatic organisms and to the local biological and biogeochemistry of the ocean. Potential impacts of elevated water temperature discharge are such as:

- (i) Coral bleaching;
- (ii) Reduction of dissolved oxygen level;
- (iii) Stimulation of phytoplankton and benthic algal growth;
- (iv) Alteration in ecosystem which affects the mortality and reproduction; and
- (v) Alteration of thermal structure of the ocean, current patterns, surface wave patterns.

206. The most practical location of the discharge pipe and outfall of the cooling water from the condenser is the southern side of the project site (and of the island) that is facing the open sea. In order to identify the best section through which the discharge pipe should be positioned, underwater marine life survey including a reef profile survey was conducted along the 500-meter stretch of the southern coastal boundary of the project site. Initially in 2018, two underwater marine survey was conducted at this stretch and found no significant marine life in the area. See tagged locations M1 and M2 in Figure 53 in Section V. However, information describes the description of the underwater ecosystem up to a depth of 10 meters only. In order to gain robust understanding of the underwater ecology in the area, additional underwater survey was conducted in September 2019. Three specific sections were identified for this additional survey which are tagged as M8, M9 and M10 in

**Figure 11** below.

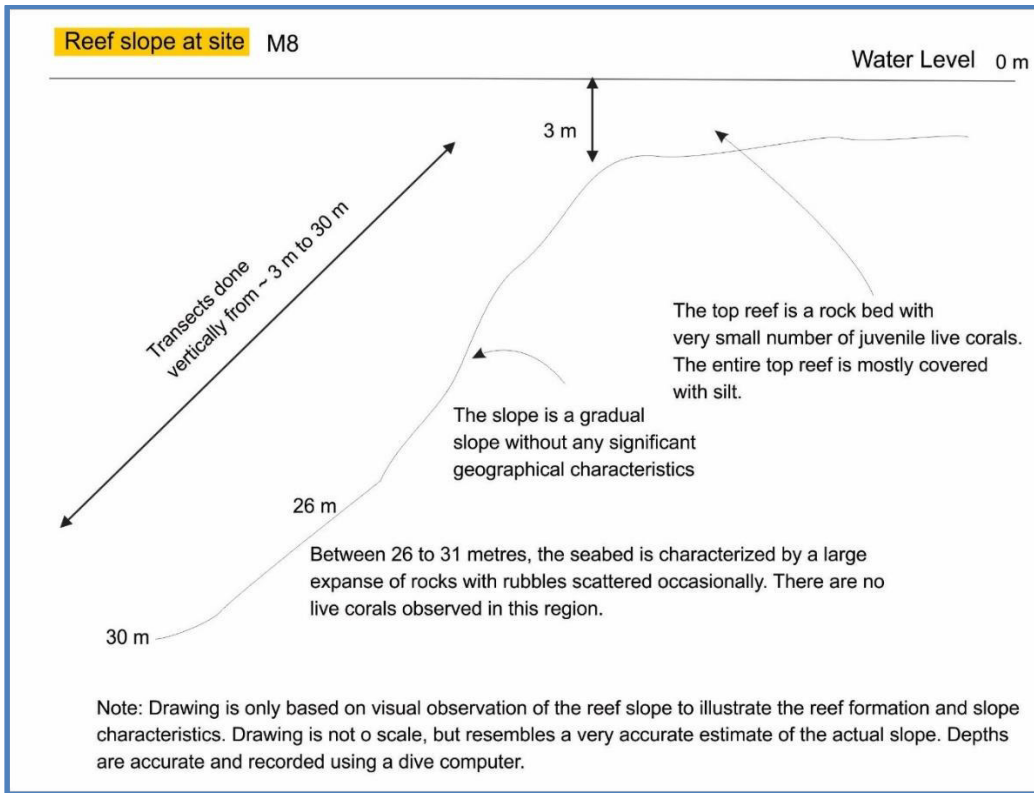
**Figure 11: Alternative Locations for Cooling Water Discharge Line (M8, M9, M10)**



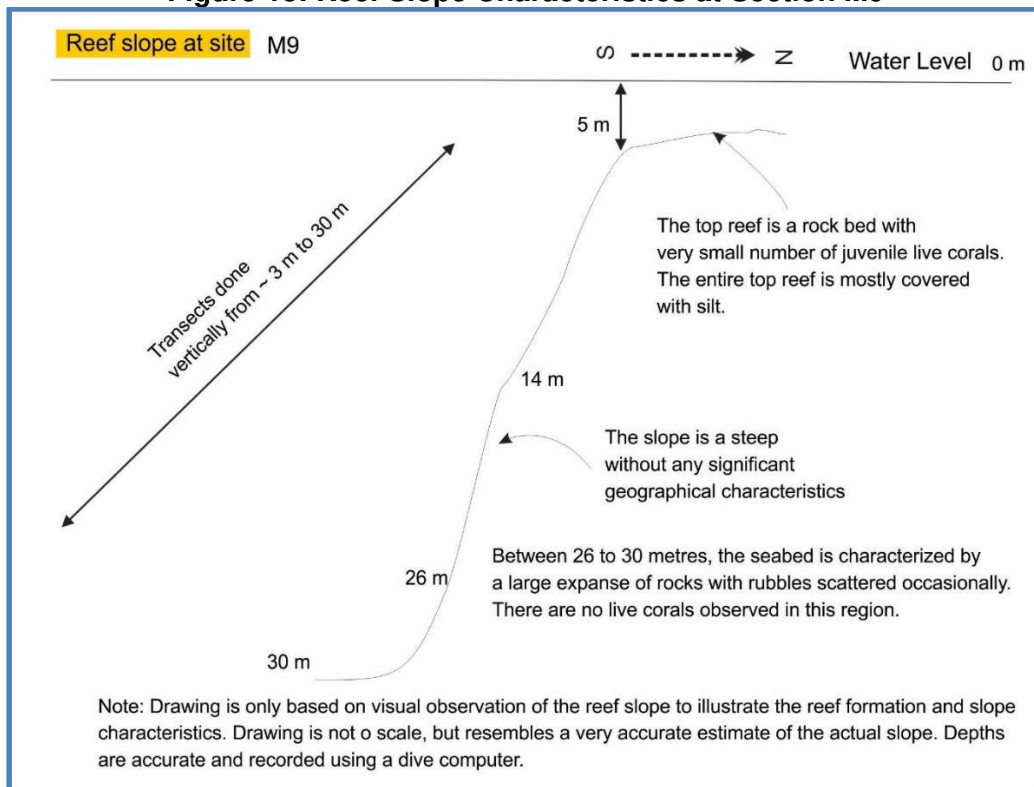
207. Results show that at these three alternative sections, underwater characteristics and profiles are the same wherein fish life, fish abundance and coral reef system have been rated as “very poor”. The rating of “very poor” means that the entire stretch of the study area has uniform characteristics of mostly dead corals, very rare pelagic life and diversity as very low. At the depth of more than 20 meters, results also show that the seabed is generally characterized by large expanse of rocks with no live corals. The figures below summarize the findings related to underwater marine life at these alternative sections studied. A complete report on this underwater survey is attached as Appendix 7.

208. The underwater study findings confirm that the extent of marine biota is too low in the survey area. The impact of discharge of cooling water to marine ecology in this area is not significant regardless of where the outfall is positioned at any of these three alternative sections considered. Given this scenario, the deciding factor for choosing the best section to locate the discharge pipe has been on the selection on which section has the best reef slope to anchor the discharge pipe effectively and efficiently. Comparison among the alternatives indicates that M8 section is the best alternative because of its gradual slope and least geographical characteristics compared to M9 and M10 sections. M9 section is considered too steep, while M10 section has relatively uneven slope with small cave feature at depth of around 7 – 10 meters. Slope characteristics and profiles at these three sections considered are illustrated in Figure 12 to Figure 14 below.

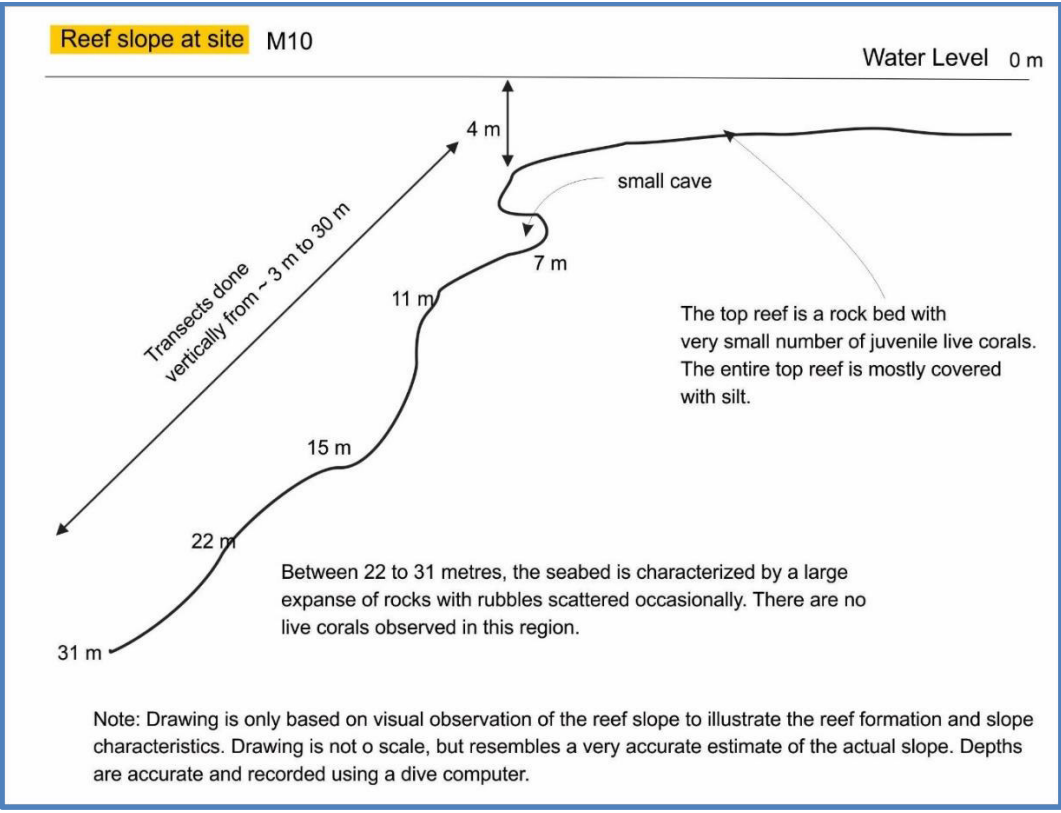
**Figure 12: Reef Slope Characteristics at Section M8**



**Figure 13: Reef Slope Characteristics at Section M9**



**Figure 14: Reef Slope Characteristics at Section M10**



**1. Outfall Position of the Cooling Water Discharge Pipe**

209. At the chosen M8 section, pelagic life such as fishes may roam the upper layer of the underwater study area (potential pelagic zone). Therefore, the outfall or tip of the discharge pipe should be positioned at a certain depth that will not cause any thermal impact to the potential pelagic zone.

**Figure 15** below shows the position of the outfall and its distance of 70 m from the shoreline.



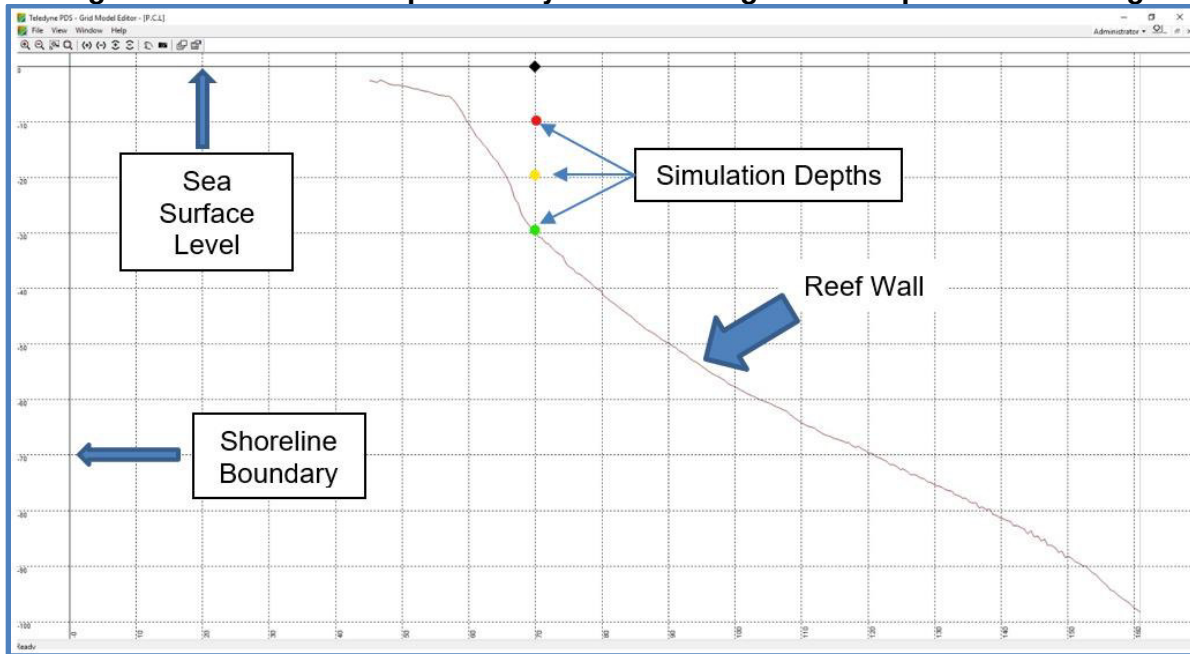
**Figure 15: Recommended Location of Outfall at M8 Section**



210. **Cooling Water Dispersion Modeling.** A dispersion modeling has been conducted to simulate the heat dissipation of cooling water as it is discharged undersea. In this modeling process, initial dilution is estimated using a near field model (CORMIX). Using its results, the depth average diluted thermal factors are obtained and fed them to a far field model (MIKE 21 HD Thermal Dispersion). Finally spreading of thermal plume in 2D plain can be obtained.

211. Three different flow rates for three different excess temperature are required to consider in the simulations. In order to find out best location (depth) for the outfall, three different depths (10m, 20m, and 30m depths) are proposed for the simulations. See Figure 16 for the layout that shows the various depths considered in the modeling relative to the bathymetry.

**Figure 16: Alternative Depths Analyzed in Cooling Water Dispersion Modeling**



212. In addition, two different monsoon and tidal conditions are also considered. Therefore, all together 36 number of scenarios are required to simulate. All simulation scenarios are given in the following table.

**Table 15: Simulation Scenarios**

Scenario ID	Monsoon	Tide	Excess Temperature (°C)	Flow Rate (m <sup>3</sup> /h)	Depth at Discharge (m)
NE_S_01	Northeast	Spring	2.5	16.56	10
NE_S_02					20
NE_S_03					30
NE_S_04		Spring	5	8.28	10
NE_S_05					20
NE_S_06					30
NE_S_07		Spring	10	6.21	10
NE_S_08					20
NE_S_09					30
NE_N_01	Northeast	Neap	2.5	16.56	10
NE_N_02					20
NE_N_03					30
NE_N_04		Neap	5	8.28	10
NE_N_05					20
NE_N_06					30
NE_N_07		Neap	10	6.21	10
NE_N_08					20
NE_N_09					30
SW_S_01	Southwest	Spring	2.5	16.56	10
SW_S_02					20
SW_S_03			5	8.28	30
SW_S_04					10

Scenario ID	Monsoon	Tide	Excess Temperature (°C)	Flow Rate (m <sup>3</sup> /h)	Depth at Discharge (m)
SW S 05			10	6.21	20
SW S 06					30
SW S 07					10
SW S 08					20
SW S 09					30
SW N 01					Neap
SW N 02		20			
SW N 03		30			
SW N 04		5	8.28	10	
SW N 05				20	
SW N 06				30	
SW N 07		10	6.21	10	
SW N 08				20	
SW N 09				30	

213. **Near Field Modeling.** Based on preliminary design, the given outfall pipe diameter is 300 mm. Accordingly discharge velocity of plume is between 0.065m/s and 0.0244m/s which are significantly low compared to the sea current at location. It will be released close to the sea bottom. Since the density of the heated plume is less it will act as negatively buoyant discharges and tends to move upwards. The initial momentum of the discharge will lead to a very turbulent flow that will attempt to mix the fluid over the full depth available. This mixing will be resisted by the fact that the discharge is buoyant. The mixing will also cause ambient fluid to be entrained into the jet, reducing its momentum and temperature. This initial momentum is very important and generally reduces the excess temperature by a factor of 2 to 3 over a distance of a few meters. Once the discharge momentum has been reduced below a certain limit due to the dilution, the mixing will cease to be the dominant factor and the discharge will transform into what is generally known as a plume. After this the discharge enters the far field. To examine the near field behavior of the heated plume CORMIX mixing zone model is used.

214. **Cormix Modeling System for the Near Field Modeling.** The CORMIX is a mixing zone model and decision support system for environmental impact assessment of regulatory mixing zones resulting from continuous point source discharges (Doneker & Jirka 2007). It is a computer-aided-design (CAD) developed by the Defrees Hydraulic Laboratory at Cornell University, Ithaca, New York, in cooperation of USEPA for studying aqueous pollutant discharges into a range of water bodies, design and mixing zone analysis (Doneker & Jirka 2007). The role of boundary interaction is the emphasis of the system for predicting steady-state mixing behavior and plume geometry (Doneker & Jirka 2007).

215. Simulation model selection in CORMIX is controlled by the graphical user interface (GUI) and mixing zone rule-based expert systems technology. Description of discharge and ambient conditions are specified as input data in the GUI. Based on the inputs, the most appropriate hydrodynamic simulation model is determined. CORMIX employs the length-scaled rule-based system for classification of flow regimes and uses the length scale for predicting the initial dilution. CORMIX simplifies the characteristics of each stage in the steady-state condition and predicts the plume dilution by using some empirical equations (Etemad-Shahidi & Azimi 2007).

216. CORMIX is applicable to wide range of problems from a simple single submerge pipe discharge into a small stream with rapid cross-sectional mixing to a complicated multiport diffuser installation in deeply stratified coastal water. However, there is lack of applicability in highly

unsteady ambient flow conditions that are prone to locally recirculating flows (Doneker & Jirka 2007).

217. The main aim is to obtain an estimation of spreading of heated plume around the discharge. The model set up used the excess temperature as a tool to access the change in temperature level. Based on the requirement, three different water depths were considered for outfall and simulations were carried out accordingly for considering all the relative environmental conditions.

218. **Model Simulations.** As discussed earlier, dilution process can be divided into a primary jet dilution in the so-called **near-field** and a subsequent natural dilution in the **far-field**. The natural dilution (far field) is influenced by waves, currents and environment conditions.

219. In general, near field of an outfall is governed by the initial jet characteristics of the plume and outfall geometry. In this case, horizontal single port discharge is considered in the modeling simulations. The density of effluent was varied from  $1017\text{kg/m}^3$  to  $1020\text{kg/m}^3$  according to the excess temperature and the ambient density of the sea water is considered as  $1025\text{kg/m}^3$ . Ambient temperature level is assumed as  $28^\circ\text{C}$ . Simulations were carried out for list of scenarios given in Table 15.

220. **Near Field Modeling Results.** Visualization of the effluent discharged from the port and rising to the surface in a cross flow at near-field region is given below for the simulation of North-East monsoon with neap tide and excess temperature  $10^\circ\text{C}$  and depth of discharge 10 m (Scenario ID: NE\_N\_07). Plan view and the elevation of the plume for this scenario are given below. The 3D view plots for rest of simulations are given in the full report of the modeling in Appendix 8.

Figure 17: Visualization of the Effluent Discharged from the Port and Rising to the Surface at Near-Field Region (3D View)

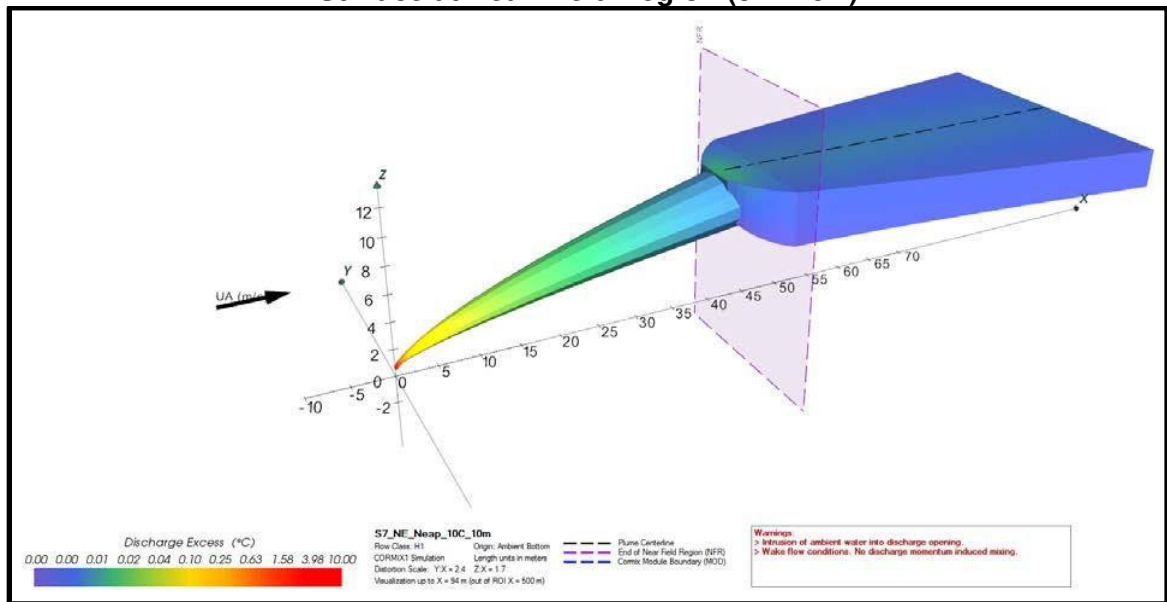
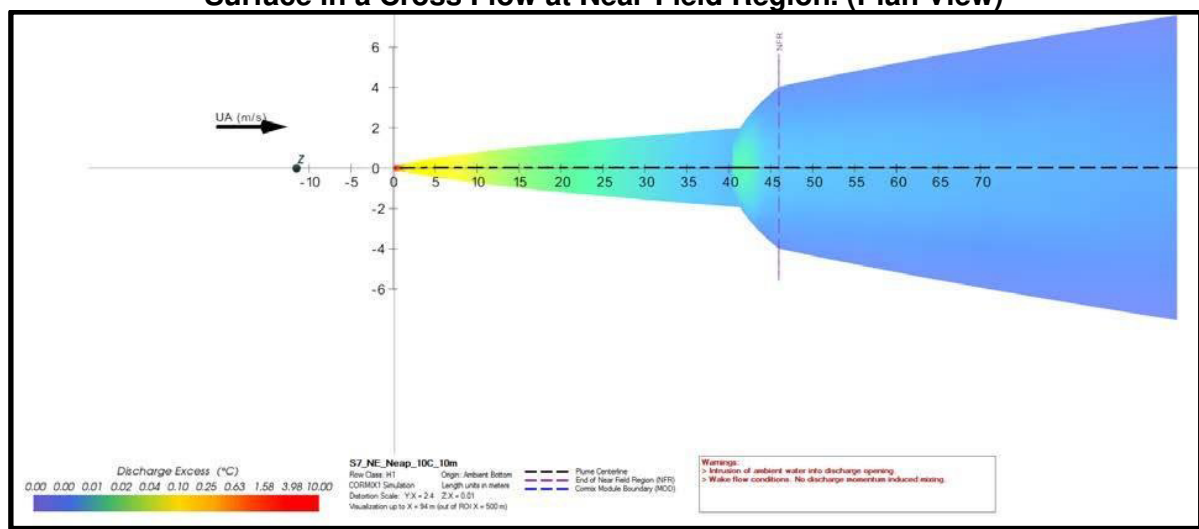
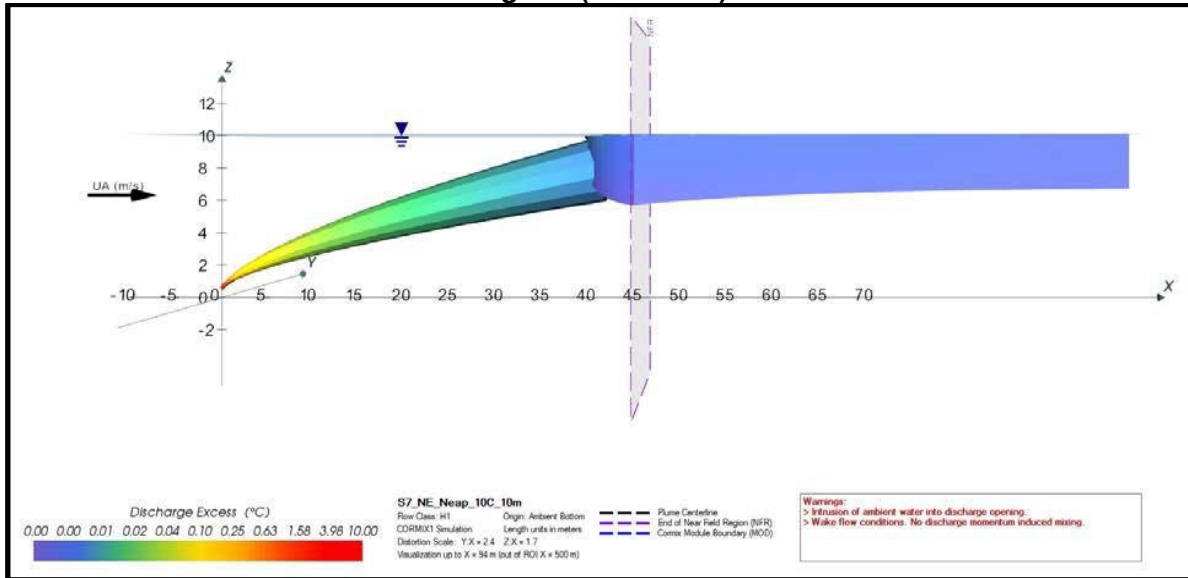


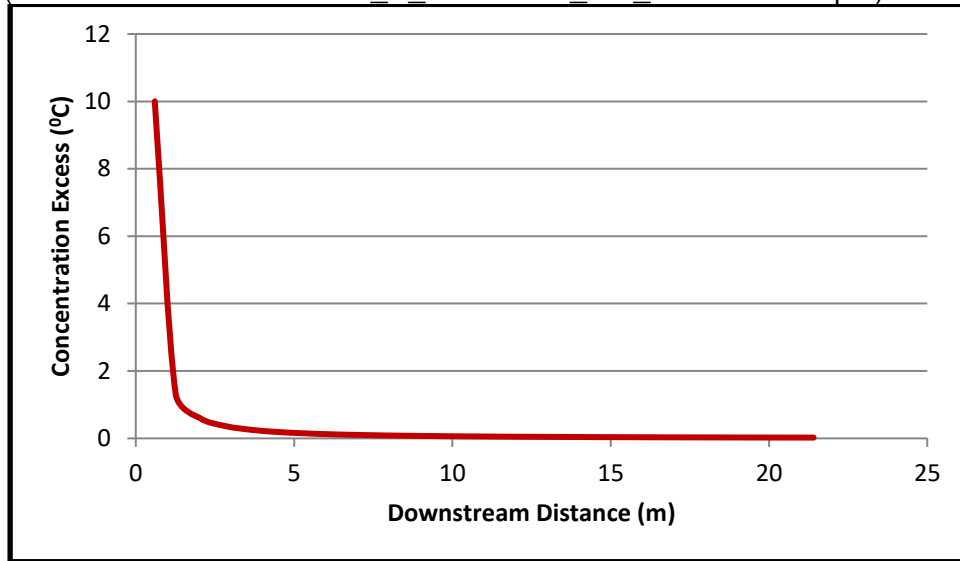
Figure 18: Visualization of the Effluent Discharged from the Port and Rising to the Surface in a Cross Flow at Near-Field Region. (Plan View)

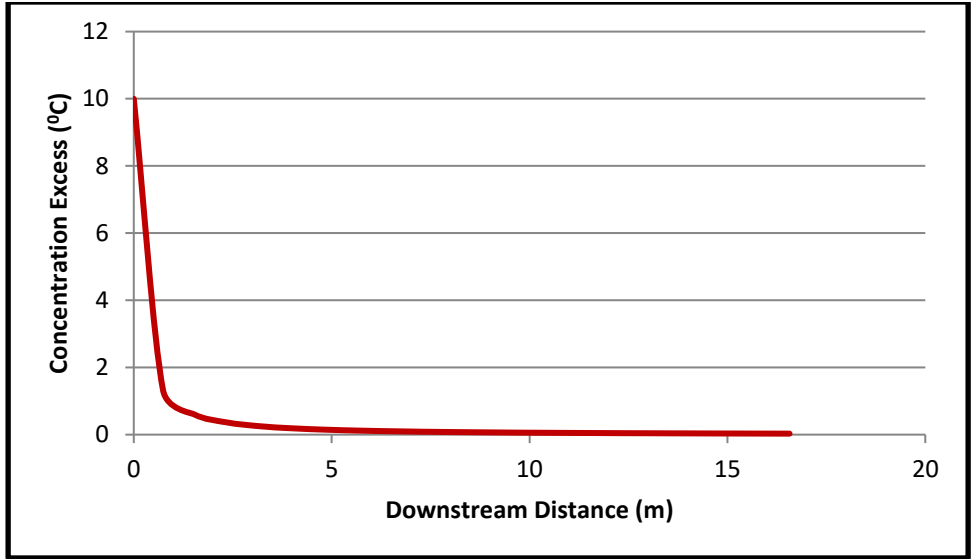


**Figure 19: Visualization of the Effluent Discharged from the Port Spreading at Near-Field Region. (Elevation)**



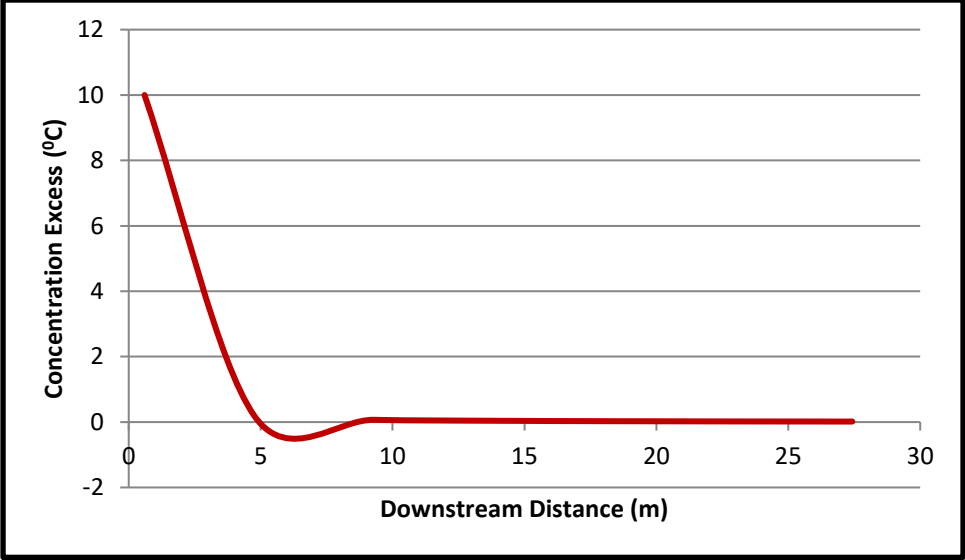
**Figure 20: Excess Concentration vs. Downstream Distance**  
 (Worst Case Scenario at NE\_N\_07 and SW\_SW\_07 at 10 m Depth)

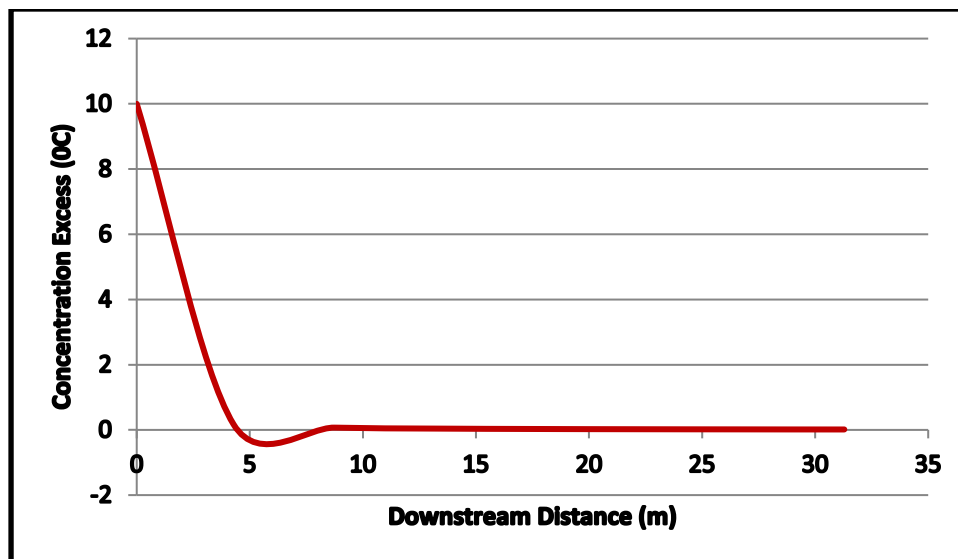




221. According to the results of above scenario, relatively high influence can be observed with low depth release, high temperature plume and low current speed. Hence, plume discharge at 10m depth with 10°C excess temperature at neap tidal condition is the most influence scenario in near-field modeling. This result is shown by scenario IDs **NE\_N\_07** and **SW\_N\_07**. Even with this most influence condition, high dilution can be observed due to low flow rate of effluent. The excess temperature reduces to less than 1°C within few meters of downstream distance. Therefore, effect on coastal environment with this discharge is negligible.

**Figure 21: Excess Concentration vs. Downstream Distance**  
(Best Case Scenario at NE\_N\_09 and SW\_N\_09 at 30 m Depth)





222. On the other hand, Figure 21 depicts the behavior of heat dissipation at the best-case scenarios at NE\_N\_09 and SW\_N\_09 at the depth of 30 m. At this point, high dilution is observed and the temperature difference is almost negligible at between 5m–10 m distance from the outfall.

223. **Far Field Modeling.** As the turbulent plume travels further away from the discharge location, the jet characteristics become less important and three-dimensional treatment of thermal dispersion is nearly changed to two dimensional treatments. In order to simulate the current phenomena, it is possible to use two-dimensional models. MIKE 21 Hydrodynamic Model combined with Thermal Dispersion Tool has been used for hydrodynamic and thermal dispersion simulation in far field region.

224. **Input Data.** All input parameters used in local hydrodynamic model are used for thermal dispersion modeling. Two different monsoon conditions (South-West and North-East) and two different tidal conditions (Spring and Neap) are taken into consideration in the simulation. Heat plume discharge boundary for far-field simulation is establish using the near-field model results. The excess temperature was extracted in mean water depth from the near-field model and given as an input data for the far field thermal dispersion model. The excess temperature extracted for different scenarios are given in Table 16.

**Table 16: Input Excess Temperature for Far-Field Model**

Sc. ID	Monsoon	Tide	Excess Temperature (°C)	Flow Rate (m <sup>3</sup> /h)	Depth at Discharge (m)	Excess Temperature at Average Depth (°C)	
NE_S_01	North-East	Spring	2.5	16.56	10	0.015	
NE_S_02					20	0.002	
NE_S_03					30	0.001	
NE_S_04			5		8.28	10	0.006
NE_S_05			20		0.002		
NE_S_06			30		0.001		
NE_S_07			10		6.21	10	0.011



Sc. ID	Monsoon	Tide	Excess Temperature (°C)	Flow Rate (m <sup>3</sup> /h)	Depth at Discharge (m)	Excess Temperature at Average Depth (°C)
NE_S_08		Neap	2.5	16.56	20	0.004
NE_S_09					30	0.002
NE_N_01					10	0.015
NE_N_02					20	0.004
NE_N_03					30	0.002
NE_N_04					10	0.016
NE_N_05		20	0.004			
NE_N_06		30	0.002			
NE_N_07		10	0.024			
NE_N_08		20	0.005			
NE_N_09		30	0.002			
SW_S_01		South-West	Spring	2.5	16.56	10
SW_S_02	20					0.002
SW_S_03	30					0.001
SW_S_04	10					0.005
SW_S_05	20					0.001
SW_S_06	30					0.001
SW_S_07	10					0.007
SW_S_08	20					0.002
SW_S_09	30					0.001
SW_N_01	Neap		2.5	16.56	10	0.016
SW_N_02					20	0.004
SW_N_03					30	0.002
SW_N_04					10	0.016
SW_N_05					20	0.004
SW_N_06					30	0.002
SW_N_07					10	0.024
SW_N_08					20	0.005
SW_N_09					30	0.002

225. Since the discharge flow rate is considerably low, high dilution can be observed at outfall area. The excess temperature at average depth is very low. The extracted values were added to the far-field model and obtained the results.

226. Results show that high influence can be observed at low depth discharge same as near-field model, but high heat distribution can also be observed for high effluent flow rate condition even it has low excess temperature. For example, Scenario ID: NE\_S\_01 has excess temperature 2.5°C in the effluent, but it has 16.56m<sup>3</sup>/h flow rate which is comparatively high. Therefore, results of this scenario show high heat distribution. Further scenarios with neap tidal condition shows

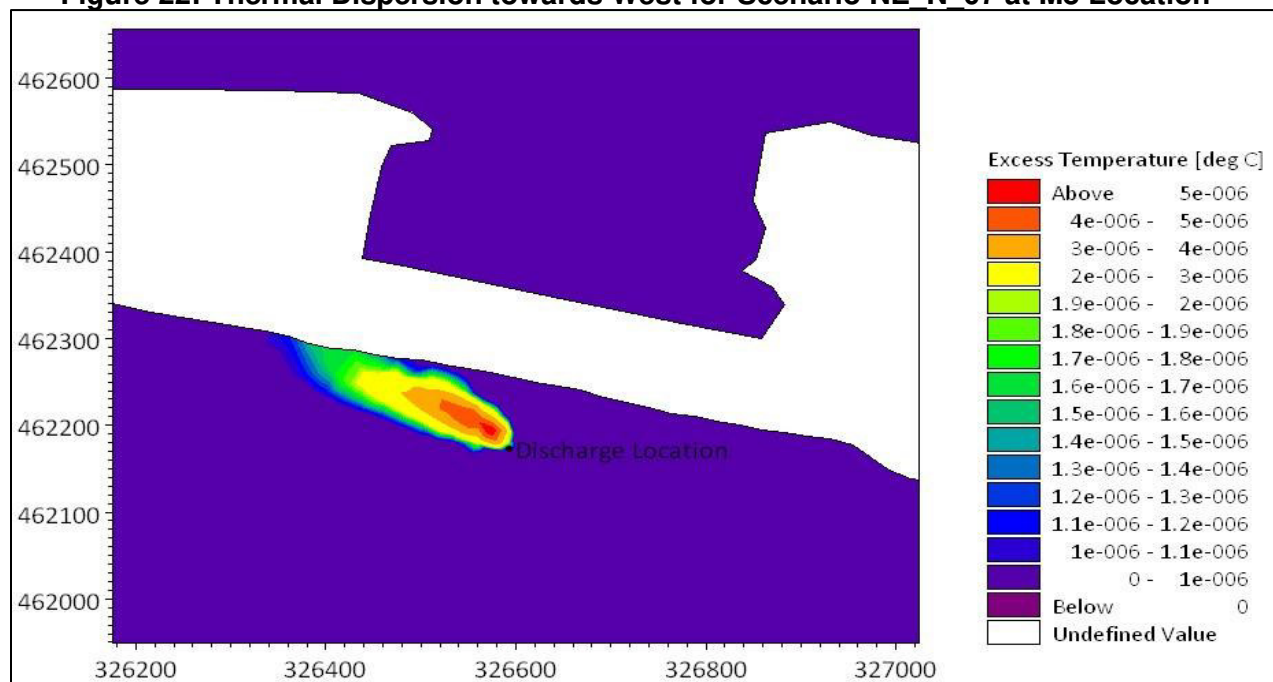
higher influence with its low current speed than spring tide. According to these conditions, high influence scenarios are:

- (i) NE\_S\_01
- (ii) NE\_N\_01
- (iii) NE\_N\_07
- (iv) SW\_S\_01
- (v) SW\_N\_01
- (vi) SW\_N\_07

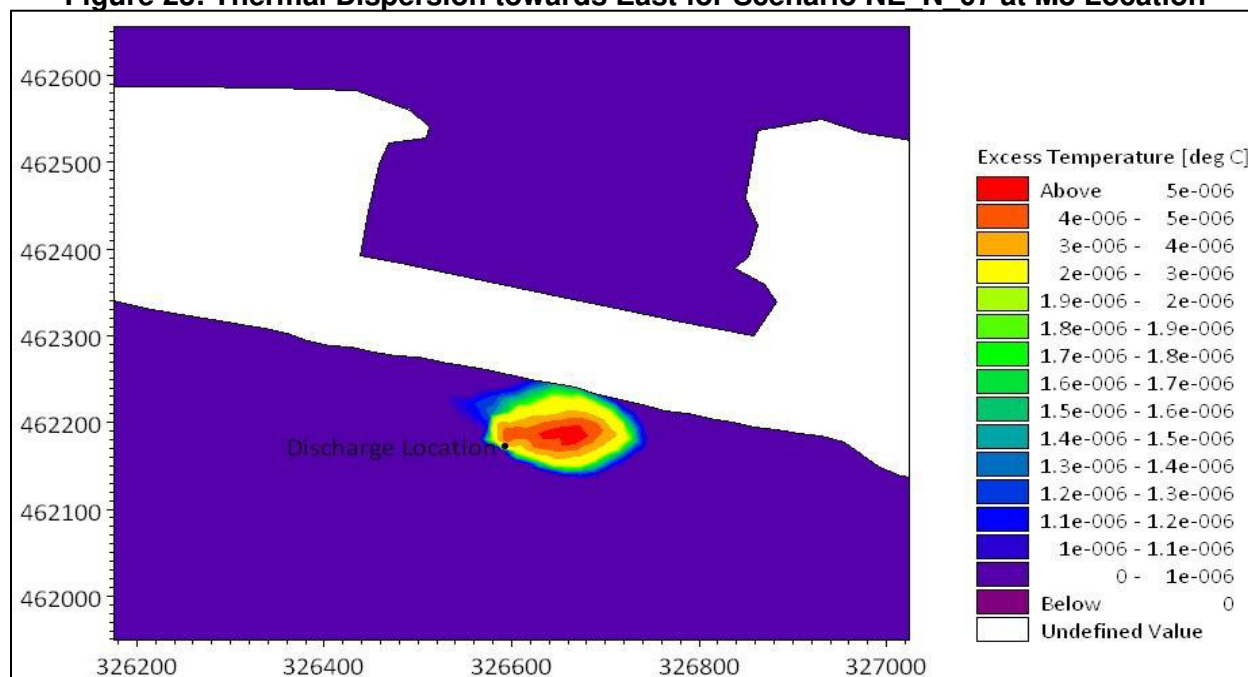
227. From the above high influence scenarios, Scenario ID NE\_N\_07 has been analyzed as critical in both near-field and far-field model and used for illustration below.

Figure 22 and Figure 23 show the temperature variation in 2D plain for this high influence scenario when current directed westward and eastward respectively. According to the results, the excess temperature level reduces to  $5 \times 10^{-6}$  °C within the 90m range from the discharge point for both cases. However,  $5 \times 10^{-6}$  °C excess temperature is still very low temperature and negligible in coastal environment. Therefore, thermal dispersion is very high even in a high influence scenario and it will have a very low effect to the coastal environment. Thermal dispersion plots for all scenarios are given in the report on Cooling Water Dispersion Modeling in Appendix 8.

**Figure 22: Thermal Dispersion towards West for Scenario NE\_N\_07 at M8 Location**



**Figure 23: Thermal Dispersion towards East for Scenario NE N 07 at M8 Location**



**228. Summary and Conclusion.** Based on the above results of modeling, summary and conclusion are as follows:

- (i) In order to find out thermal dispersion in coastal environment for outfall of hot water plume of the proposed WTE at Thilafushi Island, a set of numerical model simulation was carried out for different design conditions and seasonal conditions.
- (ii) Measured data as well as reliable predicted data were utilized as model inputs and analyzed them before applied to the model.
- (iii) MIKE 21 SW model was used to establish the wave condition at site for different monsoon periods (South-West and North-East) and MIKE 21 HD model was used to obtain the current condition at discharge point at M8 location. Further, both spring and neap tidal conditions were simulated separately, and about 0.2m/s and 0.1m/s average current speed were obtained at the discharge point for spring and neap tide respectively. Wave condition was not significantly affected on current condition at discharge point.
- (iv) Two modeling system were used thermal dispersion modeling, namely CORMIX model for **near field** dispersion and MIKE 21 HD coupled with thermal dispersion tool for **far field** dispersion.
- (v) According to near-field model results,
  - High dilution can be observed due to low flow rate of effluent.
  - High temperature reduction was observed within few meters from released point. Even in one of most influence scenarios (Scenario ID: NE\_N\_07) which has low depth of discharge (10m), high excess temperature (10°C) and low current speed (0.1m/s), temperature reduces to 1°C within 3m of range.
- (vi) Results obtained from near-field model were used as input parameter for far-field model.

- (vii) Far-field model results represent the temperature spreading in 2D plain for different scenarios.
- (viii) According to far-field model results,
  - High heat distribution can be observed with high effluent flow rate, but excess temperature is very low and negligible in coastal environment.
  - Same as the near-field model low depth discharge creates some influence compared to the other conditions.

229. In view of the above findings and conclusions, positioning the outfall at a depth of 10 meters could already reduce the excess temperature from 10°C to 1°C at a distance of 3 meters from the outfall. This is considered as the high influence scenario or worst-case scenario from the various scenarios modelled. However, this excess temperature reduction is still considered negligible as far as the vast coastal environment is concerned. From the graphical presentation in Figure 20, the distance from the outfall through which the heat will completely dissipate is at around 6 – 7 meters. At this radial distance, no marine life or ecology will be impacted since the underwater survey at the area confirms so.

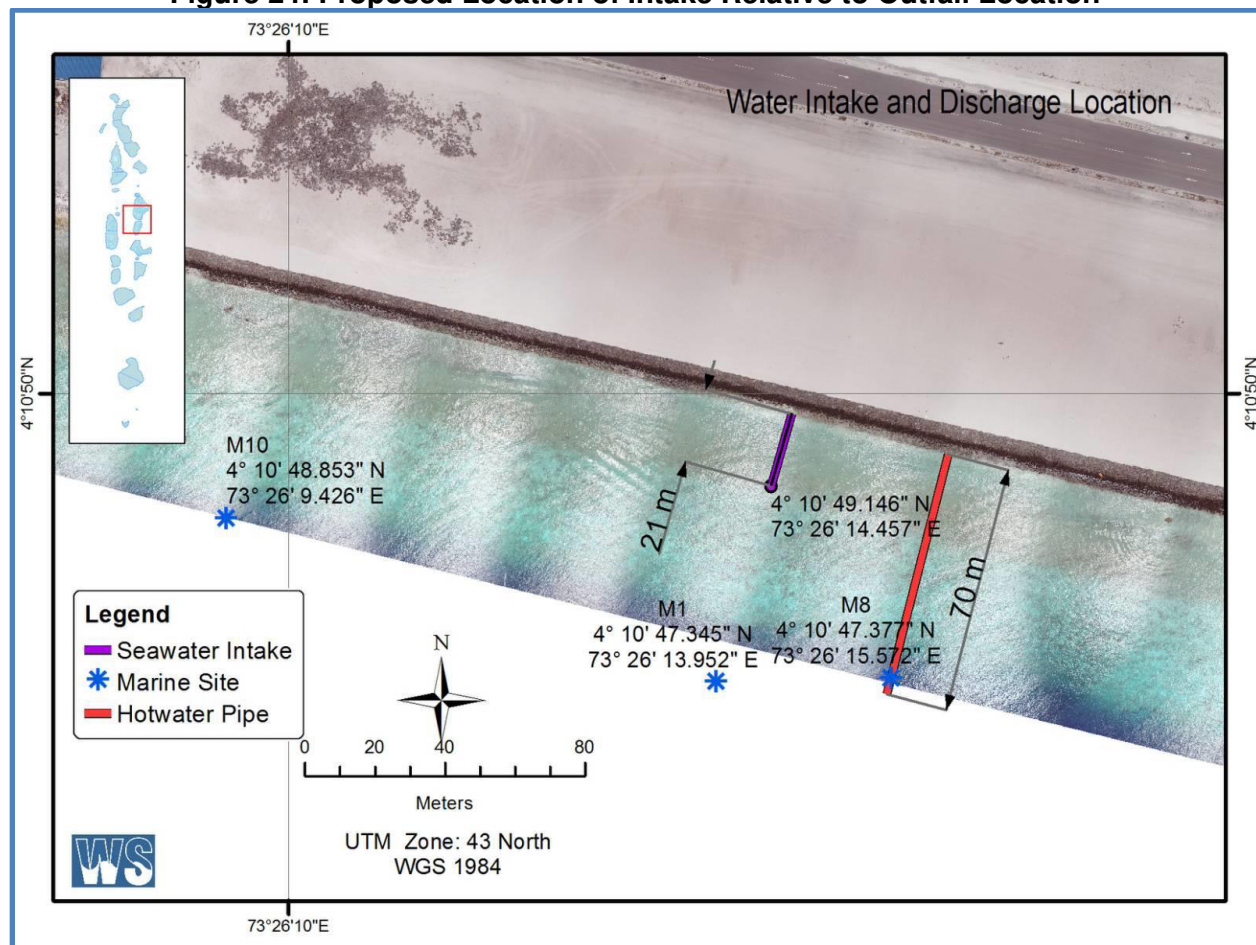
230. **Selection of Best-Case Scenario.** From the findings of the modeling, the best-case scenario is when the outfall is positioned at depth of 30 meters. The distance from the outfall through which the heat will completely dissipate is comparatively shorter than the distance expected for the two scenarios at 10m and 20m depths.

231. As a precautionary measure, the outfall of the discharge pipe shall be positioned at the depth of 30m to best ensure that no underwater marine life will be affected. The underwater survey conducted showed that there is no evidence of live corals and other marine life at this depth in the area. Further, positioning the outfall at this depth will also provide better anchor structure for the discharge pipe as it is near the reef wall.

#### **E. Alternatives on Intake Location for WTE Cooling Water**

232. The results of the underwater survey at the southern coastal section of the project site (M1, M8, M9, and M10) reveals no significant underwater marine life at these locations. This provides greater flexibility for the DBO Contractor to position the intake location of cooling water at any of these locations. However, in order to reduce impacts on the shoreline during construction phase, intake location will be positioned at the vicinity of Sections M1 and M8. This will ensure that construction of intake and discharge line structures, will be integrated and undertaken coherently at the same or close alignment and location. See Figure 24 for recommended position of the inlet structure.

**Figure 24: Proposed Location of Intake Relative to Outfall Location**



233. The DBO Contractor shall include in its final detailed design the condition that the inlet opening of its sub-surface intake line is positioned at least 15 meters from the outfall and away from the direction of the cooling water jet plume. At this minimum distance from the outfall, the seawater temperature is considered at ambient level. As a precautionary measure, it is recommended that the inlet will be positioned farther than this minimum distance.

## V. DESCRIPTION OF THE ENVIRONMENT

### A. Geology and Topography

234. Thilafushi is located in North Malé atoll, 9.5km from Malé. In terms of geographic coordinates, it is located at 04° 11' 00" N and 73° 26' 44" E. The nearest inhabited island is Villingili, approximately 7.1 km east of Thilafushi. Thilafushi Island has been developed as a solid waste landfill since December 1992. The island was initially developed as a sand bank using dredged material from the Thilafushi Reef. Since then, land has been reclaimed by placing solid waste in dredged holes on the reef flat and later topping it up with fresh lagoon sand. The island referred to as Thilafushi-1 was and is being reclaimed using this method. A second island, zoned as Thilafushi-2 (where the project will be located), was reclaimed from lagoon sand. Subsequently a third island, Thilafushi-3, was initiated to reclaim 167 Ha of land from the remaining reef areas of Thilafushi.

235. The islands of the Maldives occupy the central 700 km – long portion of the 3000 km – long Lacadive-Chagos submarine ridge, where they form a double chain of north-south orientated parallel atolls separated by an inner sea. The atolls rest on a submarine plateau that is 275 to 700 m deep, 700 km long and up to 130 km wide. There is several east-west trending deep (~1000 m) channels separating atoll groups.

236. The islands are low-lying Holocene features that began forming between 3000 and 5500 years ago (Woodroffe, 1992). The islands represent the most recent deposition along a submarine plateau that is underlain by approximately 2100 meters of mostly shallow-water carbonates resting on a slowly subsiding Eocene volcanic foundation (Purdy, 1981).

237. All islands of the Maldives are very low lying; more than 80% of the land area is less than 1 m above mean high tide level (MEEW, 2005).

## **B. Reclaimed Land for the Development of the WTE plant**

238. The proposed site for the establishment of the WTE plant was reclaimed in 2018. Fifteen hectares of land was reclaimed from the shallow lagoon which was located on either side of the link road that was constructed at Thilafushi. The materials for the reclamation was burrowed from North Malé Atoll with a distance of 10 km from Thilafushi using a Trailing Suction Hopper Dredger (TSHD). The dredger burrowed the material for the reclamation from burrow sites were within a depth range of 40-50m. The material from the dredger was discharged to the reclamation area via a floating pipeline which ran from the sea floor to the reclamation area, which was bunded with sand bunds from southern side of the reclamation area.

239. The site has been reclaimed to a height of +1.5 m from MSL from an average depth of - 1.5 m above the sea floor. The sand grains are angular to sub-angular in shape with gravel size varies from 20 – 30 mm in diameter and fairly uniformly graded. It can be described as loosely packed, silty, coral sand with pieces of corals and shells. Since the area had been recently reclaimed, the site does not have humus topsoil which is found on typical tropical islands. The soils have very high permeability for water. Much of the rainfall occurs as intense storms but no signs of erosion are observed, confirming high infiltration capacity.

240. The reclaimed land is similar to Hulhumale' second phase that was reclaimed in 2014. In this Hulhumale location, plate bearing tests found the soil bearing capacity with 150 Kpa bearing with maximum settlement of up to 5.52mm. The degree of compaction and maximum settlement achieved by 150Kpa bearing seems applicable to meet the requirement for the designed reclamation area (DI, 2015).

**Figure 25: Aerial Photograph of Proposed WTE plant Location at Thilafushi**



## **C. Terrestrial Environment**

### **1. Climate and Meteorology**

241. Regular meteorological observations and measurements in Maldives are limited to airports. A total of 12 airports are in operation, however meteorological observation takes place only on 5 airports. They are Hanimaadhoo in the north, Velana International Airport in the center, Kahdhoo, in the south center, Kaadehdoo, in the south, and Gan Island in the south. Observation routinely monitored and measured include, wind speed and direction, daily minimum and maximum temperature, humidity, cloud cover. Monitoring of sea-level height takes place only in Hulhulhe (center) and in Gan Island (south).

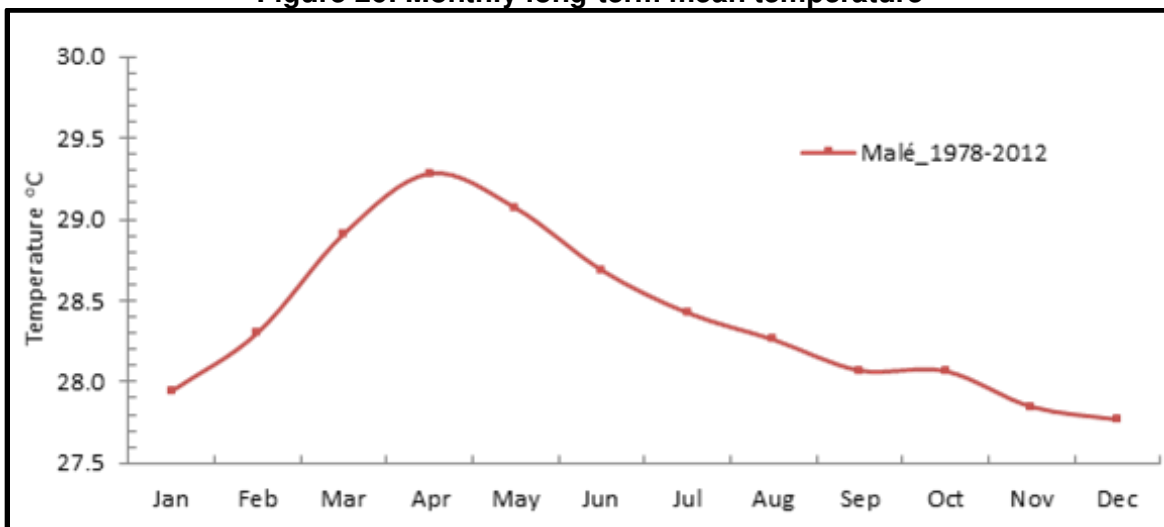
242. It is a fair and reasonable to assume that average climate conditions do not show much variation between different islands. For the purposes of this EIA observations from the Velana International Airport at Hulhulhe, which is closest to the project site, will be used to describe the climate condition around the project area.

243. The climate in Maldives is warm and humid, typical of the tropics. The average temperature ranges between 25°C to 30°C and relative humidity varies from 73 – 85%. The annual average rainfall is approximately 1,950mm. As the Maldives lie on or close to the equator, the islands of the Maldives receive plenty of sunshine throughout the year. Significant variation is observed in the climate between the northern and the southern atolls. The annual average rainfall

in the southern atolls is higher than the northern atolls. In addition, greater extremes of temperature are also recorded in the southern atolls. On average, the southern atolls receive 2,704 hours of sunshine each year.

244. **Temperature.** Central region of the Maldives experiences a warm and humid climate throughout the year. Temperature is moderated by the presence of vast sea and oceans surrounding the small islands. The long-term average temperature ranges from 25°C to 31°C. With the influence of the monsoon, seasonal fluctuations are observed throughout the year. The warmest period is observed during March, April and May with higher temperatures in the north. Figure 26 depicts the monthly variation in Malé.

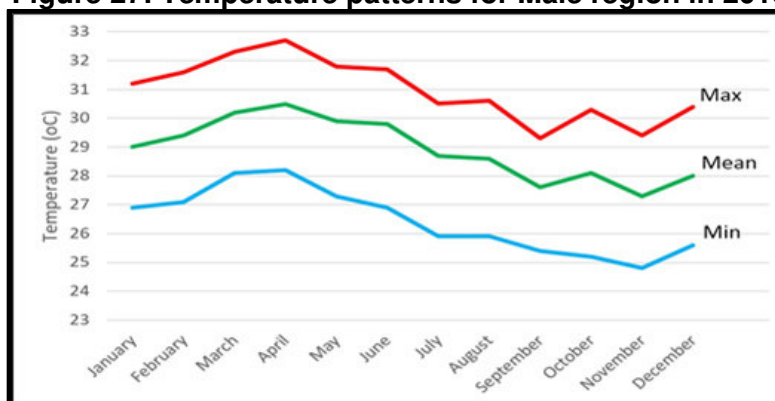
**Figure 26: Monthly long-term mean temperature**



Source: MEE, 2015

245. The highest temperature recorded in the Greater Malé region last year was on April 2016. The temperature recorded was 32.7 degree Celsius. The minimum temperature recorded in this region last year was on November 2016. The temperature recorded was 24.8 degree Celsius. Figure 27 below shows the monthly maximum, minimum and mean temperature for the year 2016. Data was obtained from Maldives Meteorological Service.

**Figure 27: Temperature patterns for Malé region in 2016**

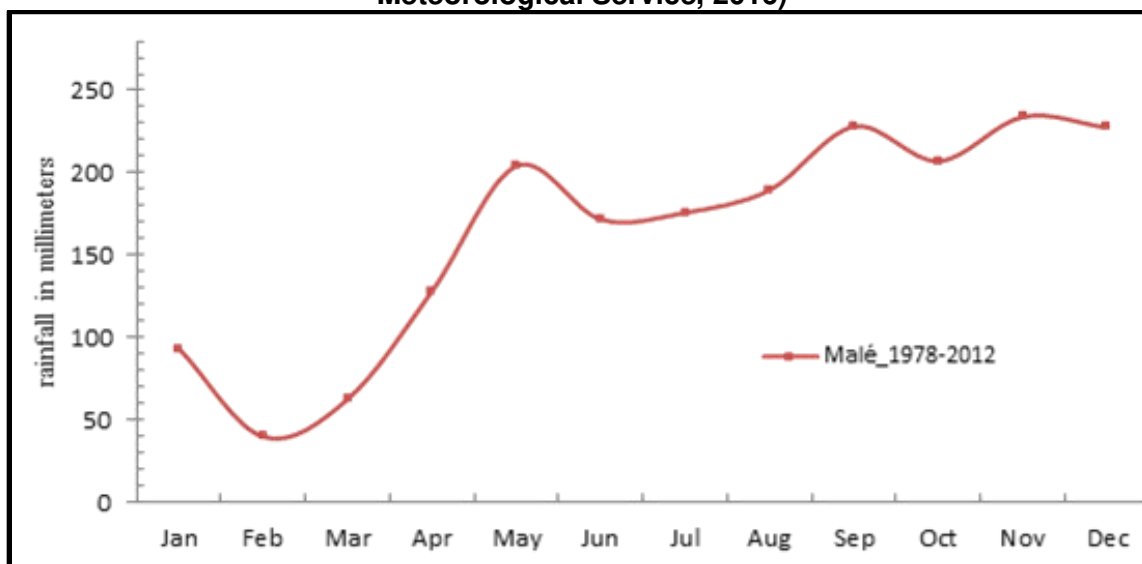




246. **Rainfall.** The rainfall over the Maldives varies during the two monsoon periods with more rainfall during the southwest monsoon. These seasonal characteristics can be seen from Figure 28, which shows the mean monthly rainfall observed for central atolls.

247. The average annual rainfall for the archipelago is 2,124 mm. There are regional variations in average annual rainfall: southern atolls receive approximately 2,280 mm, and northern atolls receive approximately 1,790 mm annually (MEE, 2015). Mean monthly rainfall also varies substantially throughout the year with the dry season getting considerably less rainfall. This pattern is less prominent in the southern half, however. The proportions of flood and drought years are relatively small throughout the archipelago, and the southern half is less prone to drought (UNDP, 2006).

**Figure 28: Long term average rainfall for the central atolls (Source: Maldives Meteorological Service, 2016)**



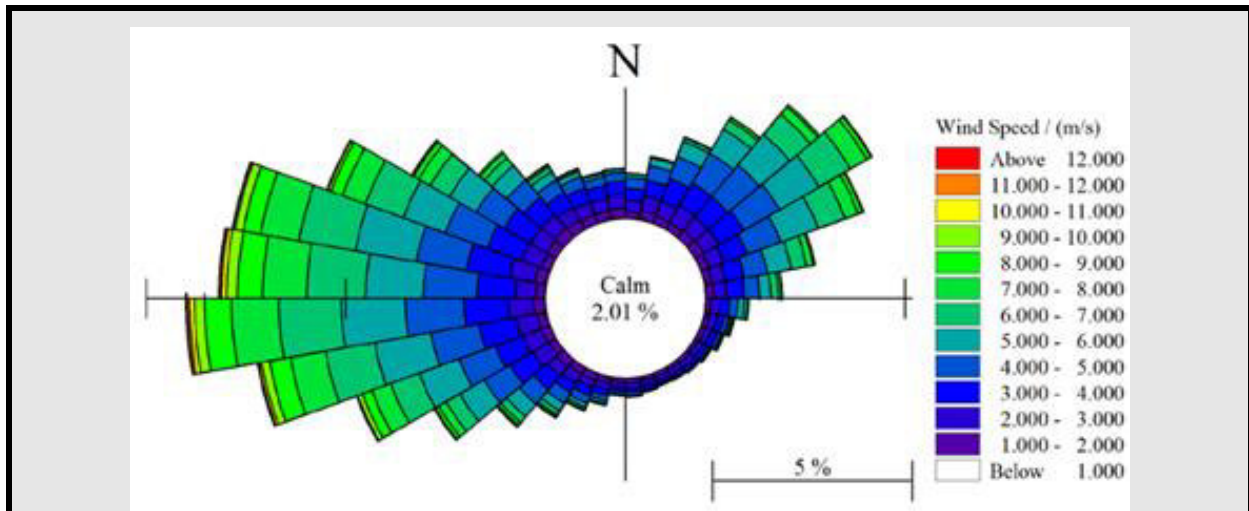
248. For Malé region the highest rainfall recorded is 310.3mm during August and lowest rainfall recorded is 4.3mm during March 2016.

249. **Monsoon.** Monsoons of Indian Ocean govern the climatology of the Maldives. Monsoon wind reversal plays a significant role in weather patterns. Two monsoon seasons are observed in Maldives: the Northeast (Iruvai) and the Southwest (Hulhangu) monsoon. Monsoons can be best characterized by wind and rainfall patterns. The southwest monsoon lasts from May to September and the northeast monsoon occurs from December to February. The transition period of southwest monsoon, which is the driest part of the year, occurs between March and April while that of northeast monsoon occurs between October and November.

250. **Wind.** The prevailing wind over the Maldives represents typical Asian monsoonal characteristics. It follows the traditional definition of monsoon as seasonal reversal of wind direction by more than 120° between the months January and July. Looking at annual variations, westerly winds are predominant throughout the country, varying between west-southwest and west-northwest. Figure 29 shows the annual wind pattern. More specific to monthly variations, easterly winds are predominant for December to February. The month of March is a combination of easterly and NW winds, while westerly winds are predominant for the rest of the year. Figure 30 shows the monthly wind patterns.

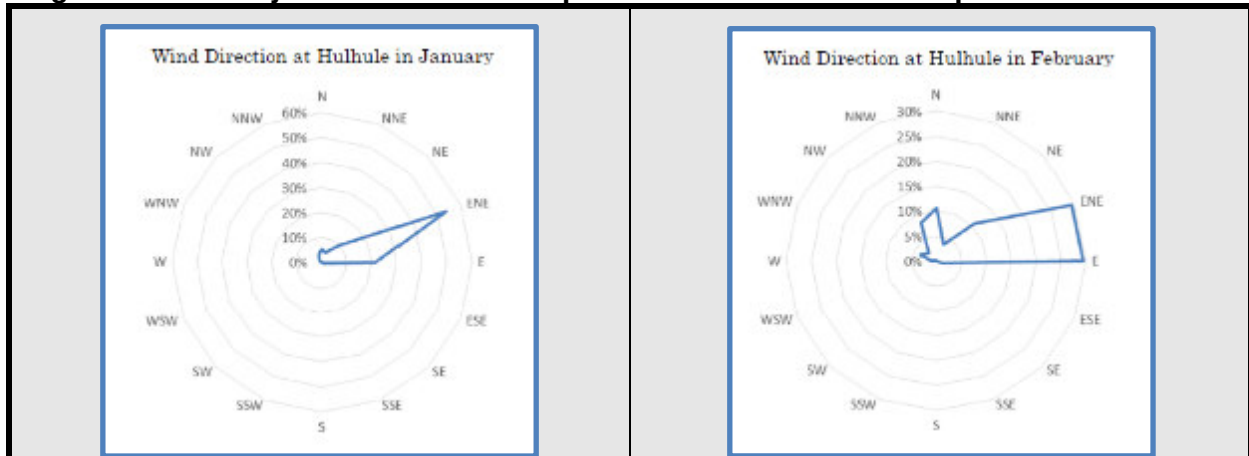
251. The southwest monsoon, with winds predominantly between SW and NW, lasts from May to October. In May and June, winds are mainly from WSW to WNW, and in July to October, winds between W and NW predominate. The northeast monsoon, with winds predominantly from NE to E, lasts from December to February. During March and April, winds are variable. During November, winds are primarily from the west, becoming variable and can occasionally exceed 30 knots from the NE sector. However, yearly wind speed in the northeast and southwest monsoons are observed to be between 9-13 knots.

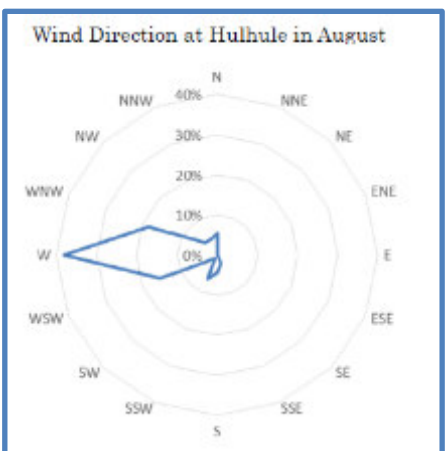
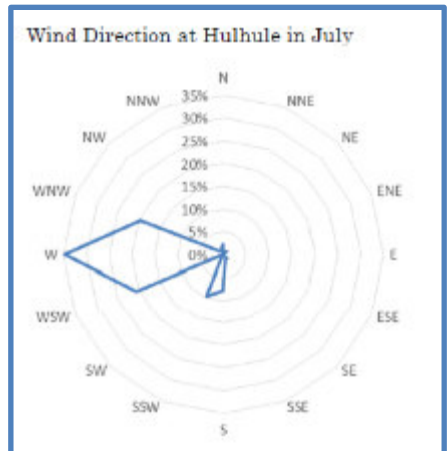
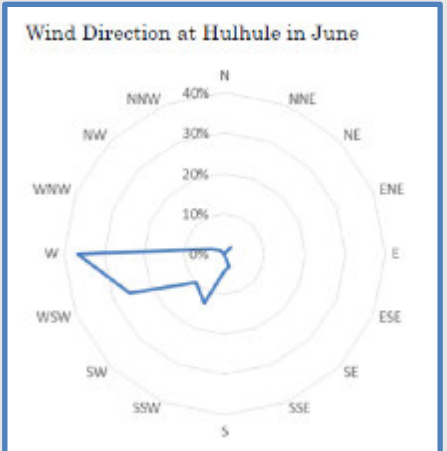
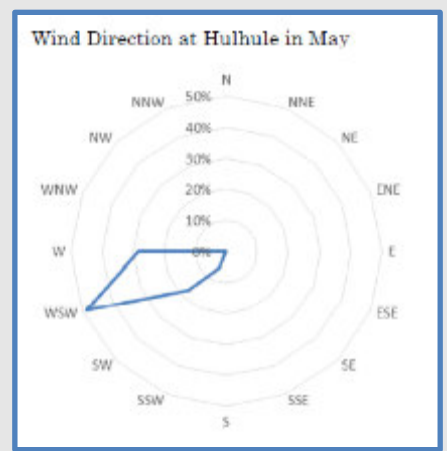
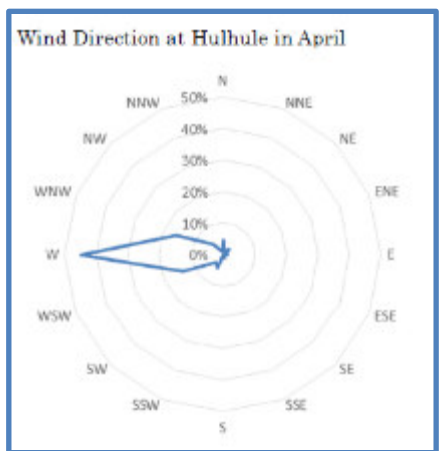
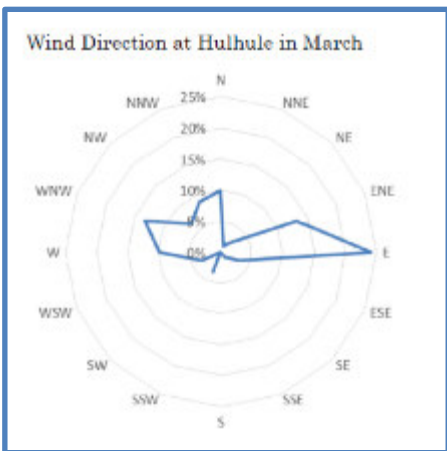
**Figure 29: Seasonal Wind Pattern and Spatial Distribution of Wind Speed and Directions from 1986-2016**

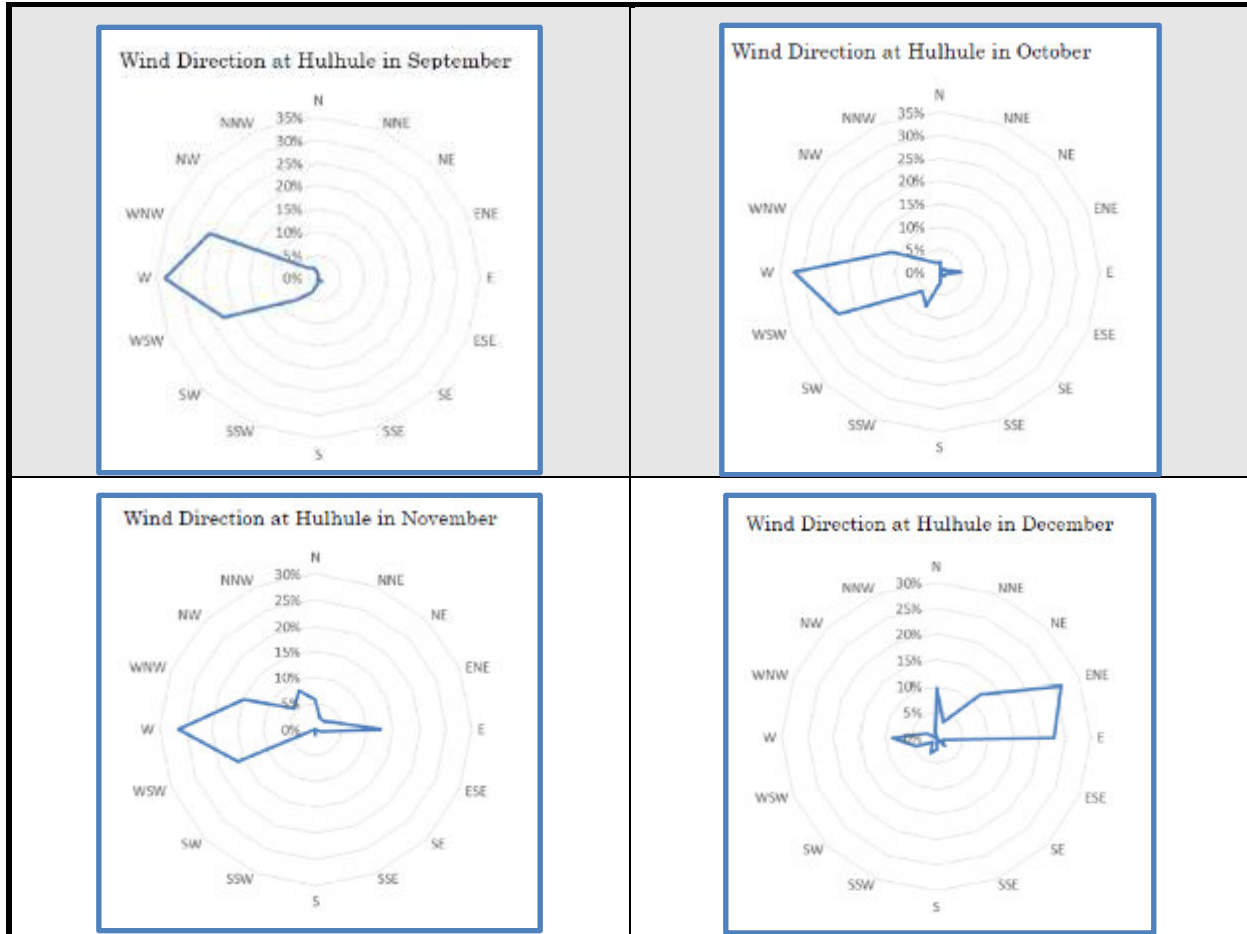


Source: LHI (2018)

**Figure 30: Monthly Wind Pattern and Spatial Distribution of Wind Speed and Directions**





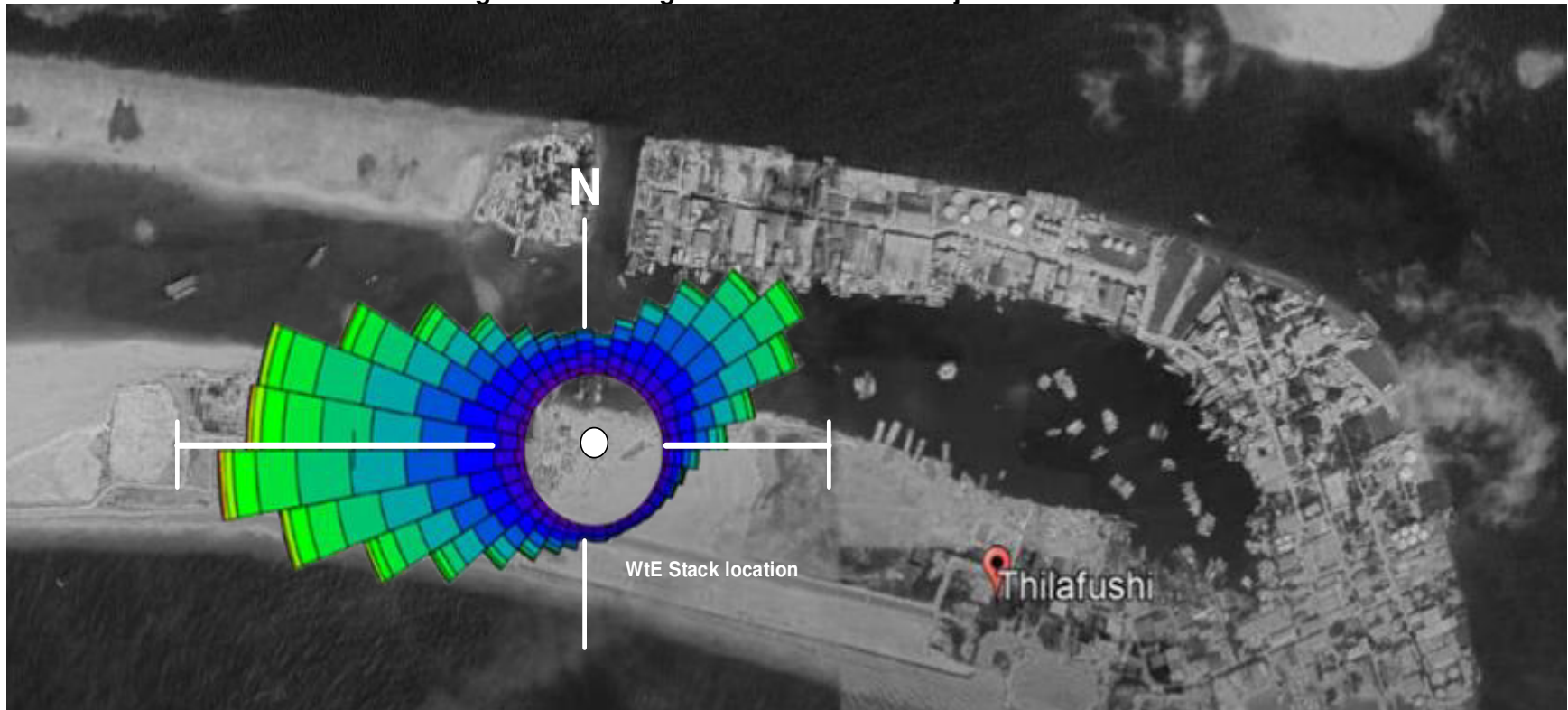


252. Figure 29 illustrates clearly the wind distribution pattern in terms of direction and frequency. The length of the “slices” represents the percentage of occurrence while the color code illustrates wind speed. Furthermore, Figure 29 shows the occurrence of wind by values in different directions and various speeds. According to the analysis, two dominant wind directions can be observed; i.e. West and North-East. The wind from the South-East quadrant is negligible. Significantly, calm conditions are rare, occurring 2.01% of the time. Figure 32 shows the wind pattern at the proposed project site by superimposing the wind rose pattern over the project site map.

Figure 31: Directional Distribution of Wind Statistics (% Occurrence for Wind Speed vs. Wind Direction)

Dir (Deg N) Speed (m/s)	Dir (Deg N)																																				Total				
	0-10	10-20	20-30	30-40	40-50	50-60	60-70	70-80	80-90	90-100	100-110	110-120	120-130	130-140	140-150	150-160	160-170	170-180	180-190	190-200	200-210	210-220	220-230	230-240	240-250	250-260	260-270	270-280	280-290	290-300	300-310	310-320	320-330	330-340	340-350	350-360					
0-1	0.03	0.08	0.06	0.05	0.06	0.07	0.06	0.04	0.09	0.03	0.03	0.05	0.04	0.06	0.05	0.04	0.05	0.00	0.03	0.06	0.07	0.06	0.06	0.06	0.07	0.06	0.11	0.03	0.06	0.07	0.06	0.06	0.06	0.07	0.06	0.06	0.06	0.03	2.07		
1-2	0.17	0.24	0.20	0.21	0.24	0.26	0.21	0.19	0.20	0.14	0.14	0.14	0.10	0.12	0.10	0.10	0.11	0.12	0.11	0.16	0.19	0.10	0.24	0.21	0.23	0.24	0.30	0.23	0.30	0.23	0.27	0.29	0.27	0.24	0.23	0.10	7.07				
2-3	0.29	0.38	0.43	0.48	0.44	0.45	0.43	0.35	0.34	0.23	0.19	0.16	0.15	0.14	0.13	0.11	0.11	0.13	0.12	0.17	0.19	0.26	0.32	0.40	0.51	0.53	0.64	0.53	0.64	0.54	0.48	0.45	0.30	0.34	0.31	0.29	12.16				
3-4	0.31	0.40	0.57	0.67	0.67	0.72	0.60	0.49	0.42	0.24	0.19	0.16	0.13	0.10	0.09	0.09	0.09	0.00	0.06	0.16	0.22	0.27	0.44	0.65	0.73	0.96	1.10	0.95	1.13	0.92	0.77	0.58	0.41	0.38	0.35	0.26	16.39				
4-5	0.26	0.38	0.58	0.86	1.03	1.05	0.90	0.61	0.37	0.20	0.10	0.08	0.07	0.03	0.04	0.04	0.05	0.09	0.08	0.13	0.20	0.31	0.48	0.75	0.97	1.28	1.48	1.36	1.31	1.11	0.82	0.55	0.38	0.29	0.21	0.19	18.62				
5-6	0.10	0.19	0.42	0.68	0.89	1.13	1.00	0.58	0.30	0.16	0.06	0.05	0.03	0.03	0.03	0.01	0.04	0.05	0.04	0.07	0.11	0.21	0.41	0.70	1.07	1.40	1.63	1.45	1.51	1.15	0.75	0.48	0.23	0.14	0.09	0.08	17.39				
6-7	0.02	0.04	0.09	0.26	0.69	0.90	0.72	0.39	0.19	0.08	0.05	0.03	0.02	0.01	0.00	0.01	0.02	0.01	0.03	0.04	0.06	0.11	0.20	0.40	0.78	1.24	1.58	1.49	1.43	0.98	0.57	0.25	0.12	0.07	0.03	0.02	12.89				
7-8	0.00	0.01	0.03	0.00	0.23	0.47	0.35	0.18	0.00	0.03	0.03	0.02	0.01	0.01				0.01	0.02	0.02	0.02	0.06	0.09	0.21	0.50	0.90	1.18	1.07	0.96	0.62	0.33	0.15	0.05	0.03	0.00	0.01	7.78				
8-9		0.00	0.03	0.02	0.05	0.12	0.11	0.04	0.01	0.01	0.02	0.00						0.01	0.00	0.01	0.02	0.04	0.09	0.25	0.52	0.65	0.62	0.43	0.30	0.14	0.04	0.03	0.02				3.60				
9-10				0.02	0.04	0.05	0.03	0.00	0.00	0.00	0.00									0.00	0.01	0.01	0.02	0.12	0.21	0.24	0.28	0.21	0.08	0.04	0.01	0.00					1.30				
10-11						0.00	0.01																0.01	0.00	0.01	0.03	0.06	0.13	0.12	0.06	0.02	0.02	0.00					0.47			
11-12																										0.01	0.02	0.08	0.04	0.02	0.01	0.00	0.01						0.18		
12-13																										0.01	0.01	0.04	0.01	0.01	0.01	0.00								0.09	
13-14																								0.00			0.01	0.01												0.02	
14-15																											0.00														0.00
15-16																													0.00												0.00
Total	1.18	1.70	2.42	3.33	4.14	5.22	4.42	2.86	2.00	1.12	0.81	0.69	0.54	0.51	0.44	0.41	0.47	0.58	0.51	0.81	1.06	1.53	2.28	3.60	5.26	7.42	9.13	8.22	8.09	6.03	4.27	2.89	1.95	1.56	1.28	1.06	100				

Figure 32: Average Wind Rose Over Project Location



253. Besides the annual monsoonal wind variations, there are occasional tropical storms in the central region of the Maldives which increases wind speeds up to 110 km/h, precipitation to 30 to 40 cm over a 24 hour period and storm surges up to 3 m in the open ocean (UNDP, 2006).

254. Recent meteorological data was obtained from Lakes Environmental ([https://www.weblakes.com/services/met\\_data.html](https://www.weblakes.com/services/met_data.html)) which employs the Weather Research and Forecasting (WRF) model to compute accurate wind fields and provide modeled meteorological data.<sup>28</sup> Below is the frequency distribution and wind rose of Maldives for 2018 based on MM5 AERMET processed prognostic meteorological data.

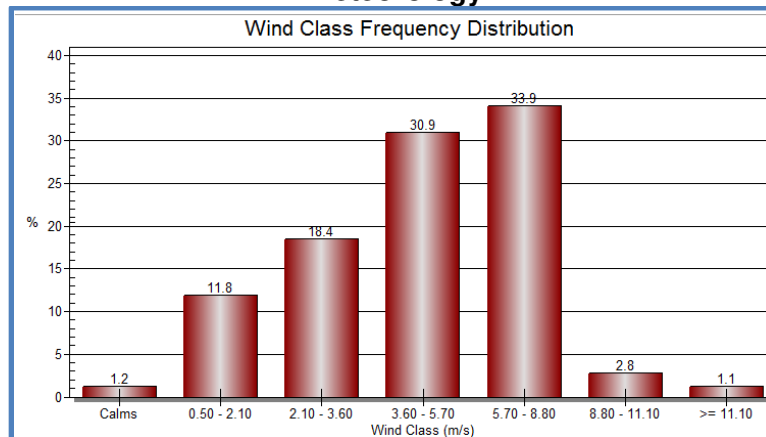
**Table 17: Wind Direction Frequency Diagram for Maldives, 2018**

	Directions / Wind Classes (m/s)	0.50 - 2.10	2.10 - 3.60	3.60 - 5.70	5.70 - 8.80	8.80 - 11.10	>= 11.10	Total
1	348.75 - 11.25	0.00502	0.00400	0.00731	0.00342	0.00000	0.00000	0.01975
2	11.25 - 33.75	0.00662	0.00628	0.01370	0.01199	0.00000	0.00000	0.03858
3	33.75 - 56.25	0.00765	0.01267	0.02500	0.01450	0.00137	0.00000	0.06119
4	56.25 - 78.75	0.00947	0.01267	0.02078	0.00970	0.00000	0.00000	0.05263
5	78.75 - 101.25	0.00811	0.01370	0.01290	0.00571	0.00000	0.00000	0.04041
6	101.25 - 123.75	0.00788	0.00993	0.00422	0.00285	0.00000	0.00011	0.02500
7	123.75 - 146.25	0.00639	0.00868	0.00685	0.00126	0.00000	0.00000	0.02317
8	146.25 - 168.75	0.00377	0.00742	0.01016	0.00354	0.00000	0.00000	0.02489
9	168.75 - 191.25	0.00491	0.00856	0.01587	0.00537	0.00000	0.00000	0.03470
10	191.25 - 213.75	0.00514	0.01438	0.02078	0.01769	0.00000	0.00000	0.05799
11	213.75 - 236.25	0.00913	0.01781	0.03185	0.05342	0.00148	0.00000	0.11370
12	236.25 - 258.75	0.00856	0.01747	0.04075	0.08950	0.01005	0.00616	0.17249
13	258.75 - 281.25	0.01005	0.01564	0.04669	0.06815	0.01107	0.00457	0.15616
14	281.25 - 303.75	0.00902	0.01450	0.02443	0.03779	0.00342	0.00034	0.08950
15	303.75 - 326.25	0.00970	0.01221	0.01975	0.00936	0.00011	0.00000	0.05114
16	326.25 - 348.75	0.00628	0.00788	0.00753	0.00502	0.00000	0.00000	0.02671
	Sub-Total	0.11769	0.18379	0.30856	0.33927	0.02751	0.01119	0.98801
	Calms							0.01199
	Missing/Incomplete							0.00000
	Total							1.00000

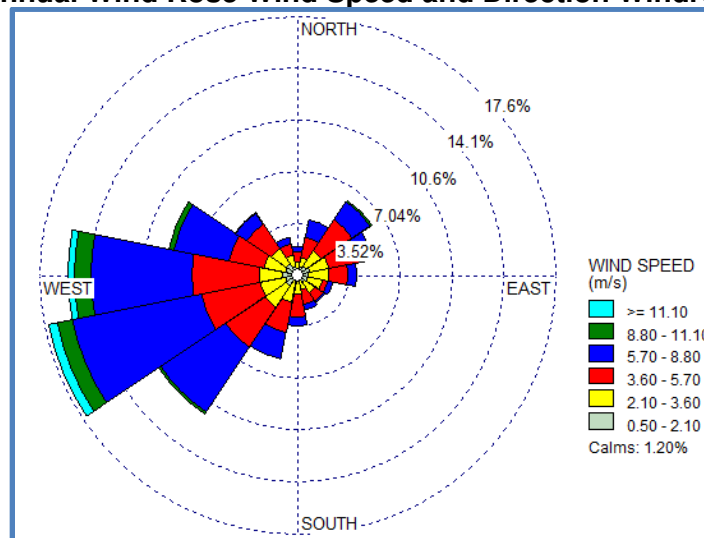
\* Reference bearing CW 90°

<sup>28</sup> The data is obtained by running the NCAR MM5 (5th-generation Mesoscale Model) prognostic meteorological model for a specified location and site domain. Once the MM5 preprocessing has been completed, the MM5 output file is converted into a format recognized by the AERMET model (meteorological preprocessor for the AERMOD model). The final output is generated by creating a pseudo met station at the specified site location.

**Figure 33: MM5 Frequency Distribution of Wind Speed and Direction 2018 Maldives Meteorology**



**Figure 34: MM5 Annual Wind Rose Wind Speed and Direction Windrose, 2018 Maldives**



255. Windrose diagram generated using WRPlot view Version 5.8 software which utilizes SCRAM (.DAT) files. Wind direction was oriented in “Blowing from” configuration. Figure above, present the annual wind rose diagram at Maldives Synoptic Station.

256. **Natural hazards. Natural hazards.** The fragile ecological profile, low elevation, combined with its economic dependence on limited sectors makes Maldives highly vulnerable to natural hazards. The disaster risk profile of Maldives identifies earthquakes and tsunamis, cyclones/thunderstorms, floods (due to rain), drought (prolonged dry periods), storm surges, strong winds, and tornadoes (waterspouts) as critical disasters to the Maldives. Climate change further exacerbates the vulnerability of Maldives to these disasters.

257. The primary sources of hazard risks in the Maldives are strong winds during monsoons or freak storms, earthquakes, island interior flooding caused by heavy rain, coastal flooding caused by high surf, storm surges, prolonged strong monsoonal winds, high astronomical tides or tsunamis, and sea level rise.



258. **Earthquakes and tsunami.** While earthquake events have been documented, there is little recorded evidence of tsunami events in historic records of the Maldives. History tells us that between 1729 and 1815 the Maldives had experienced earthquakes. Although magnitude and exact locations of these historical earthquakes around the Maldives is unavailable, descriptions of the events indicate extensive damage has been caused. Three major earthquakes of magnitude 7.0 or greater had struck the Maldives region in 1944, 1983 and 2003. Earthquakes are usually felt as tremors without notable damages. However, in 2003 an earthquake measuring 7.6 occurring in Carlsberg Ridge had reported some damage in Addu city.

259. Although 67 tsunamis originated from the Sumatra Subduction zone in the east and 13 from the Makran Coast Zone in the north and Carlsberg Transform Fault Zone in the south since 1816, historical records do not indicate that the Maldives was affected by these tsunamis. The only record of damage caused by a tsunami in the Maldives is the 26<sup>th</sup> December 2004 Indian Ocean tsunami. This was one of the most apocalyptic natural disasters experienced in Maldivian history. Wave heights of about 2.5m were recorded in Hanimaadhoo and a wave height of 2.1m was observed in Malé.

260. The disaster risk profile of Maldives (UNDP, 2006) places Thilafushi as being located in a severe tsunami risk zone with a probable maximum wave height between 3.2 and 4.5 m. The high levels of fluctuations of sea level during the Indian Ocean Tsunami showed that rising and falling of the water levels are enough to inundate any unprotected coastline of Maldives including Thilafushi Island. However, there are no records of major damages on the island. The lack of impact on Malé has been associated with the submarine topography, tide level at the time and the location of the earthquake epicenter (Ali, 2005).

261. **Cyclone, storm surges and flood.** Thilafushi Island is in a moderate cyclonic hazard zone which has the potential for a maximum probable cyclonic wind speed of 69.6 knots. It has the potential for a 1.53 m storm tide in a 500-year return period (UNDP, 2006).

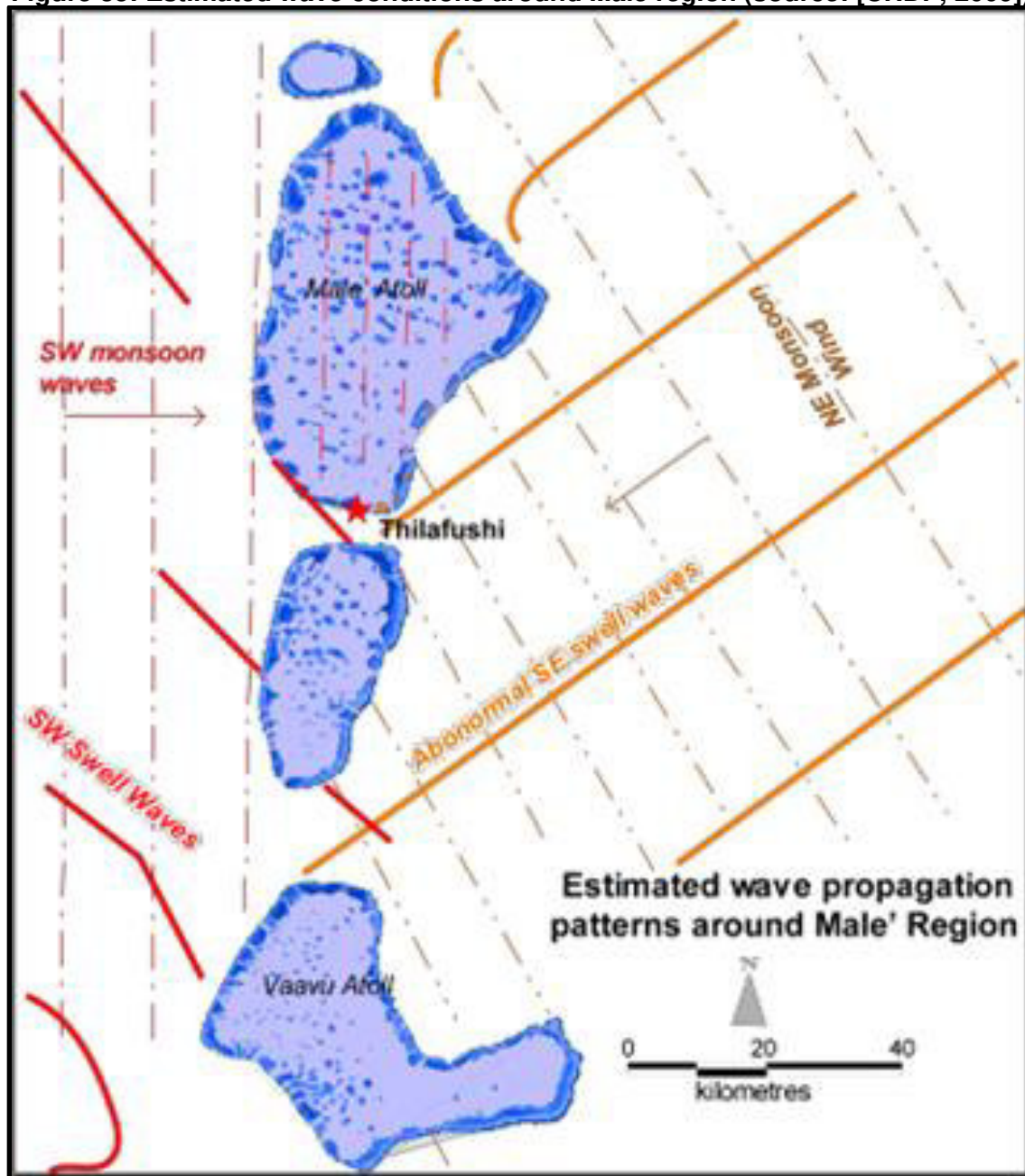
262. Wave studies around the Maldives have identified the presence of swell waves approaching predominantly from a southwest to a southerly direction (Kench et.al (2006), DHI (1999), Binnie Black & Veatch (2000) and Naseer (2003).

263. Coastal flooding and related wind damage can be considered as the most frequent natural hazards that occur in Maldives (Maniku (1990), Luthfy (1994)). Most of these risk factors (apart from earthquakes, wind damage and rainfall flooding), stem from the extremely low elevation of all Maldivian islands: the average elevation is 1.5 m above sea level. In spite of the occasional natural hazards, the Maldives are in general relatively free from high risk natural disasters.

264. Spatial variations in hazards are evident across Maldives (Maniku, 1990). Northern atolls are more exposed to intense storm systems, increasing the risk of wind damage in these atolls. In comparison, southern atolls experience less storms systems, but are more exposed to flooding events, probably as a result of exposure to intense South Indian Ocean storm surges and wind-waves during south west monsoons. Southern atolls are also more likely to experience earthquakes.

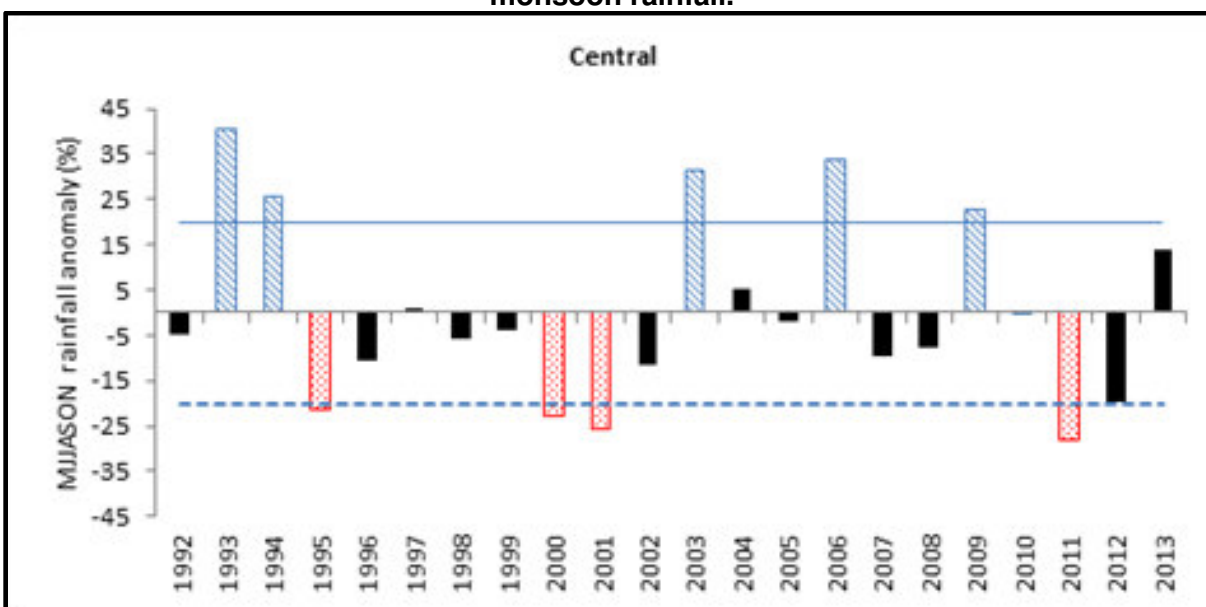
265. Thilafushi is protected from predominant swell waves. However, the island is still exposed to abnormal swell waves originating from intense storms in the southern hemisphere (Figure 35). Waves generated from such abnormal events could travel against the predominant swell propagation patterns causing flooding on the eastern and southern islands of Maldives (UNDP, 2009).

Figure 35: Estimated wave conditions around Malé region (source: [UNDP, 2009])



266. **Disasters and Extreme Events - Flooding Due to Rain.** Although floods due to rain are the most frequent natural events in the Maldives, no criteria exist for the case of the Maldives for declaring flood disasters. Furthermore, no proper mechanism exists for collecting or recording data on flood events and hence it is difficult to determine frequency of floods and their trends for the Maldives. Figure 36 shows flood years together with drought years for the central region of the Maldives (MEE, 2016). The Cross bars indicate the flood years, dotted bars indicate the drought years. The solid line is the sum of mean and standard deviation and dotted line is the difference between mean and standard deviation. It should be noted that this method identifies the likelihood of flooding and actual flood events experienced can be very different.

**Figure 36: Flood and drought years for central regions Maldives based on Maldives monsoon rainfall.**



## 2. Air Quality

267. Major causes and sources of ambient air quality deterioration in the Maldives include power generation (e.g. diesel generators), fuel combustion from motorized vehicles (e.g. motorbikes, cars), burning and incineration of municipal waste, and construction activities (e.g. dust generated from concrete, cement). In addition to these local sources, trans-boundary flow of air pollutants also contributes to the overall degradation of ambient air quality of the Maldives (United Nations Environment Program, 2002).

268. Air pollutants generated from these local sources vary in their chemical properties and composition. The pollutants can be broadly categorized into the following groups: Gaseous pollutants (e.g. SO<sub>2</sub>, NO<sub>x</sub>), Persistent Organic Pollutants (e.g. PCDDs, PCBs), Heavy Metals (e.g. Lead, Cadmium), and Particulate matter (e.g. PM<sub>2.5</sub>, PM<sub>10</sub>) (Kampa & Castanas, 2008).

269. At the proposed project site in Thilafushi, ambient air quality monitoring was conducted to document the current baseline condition at the island. Several sampling activities in 2018 and 2019 were undertaken by the PMU through its consultant, Water Solutions. Three locations were selected at Thilafushi and one location at Villingili. Villingili is the nearest inhabited island and the sampling site at this island will serve as the control site for future monitoring activities under the project. The air quality monitoring activities were done for a period of one week each in 2018 and 2019.

270. **Selection of Sampling Locations.** In total, ambient air quality monitoring was conducted at 4 locations. First station (AQ1) was selected in the downwind direction of the proposed project site (i.e. the potential direction of stack emission plume from the plant), and second station (AQ2) was placed at the crosswind direction of the plume. Third station (AQ3) was selected in the crosswind direction of the smoke plume from the existing dump site at Thilafushi. Fourth station (AQ4) was selected at Villingili as a control site. See Figure 37 below for these locations as shown on the map.

**Figure 37: Sampling Locations of Ambient Air Quality Monitoring**



271. Predominant wind direction is an important criterion in selection of the air quality sampling stations as gaseous and particulate emissions from the project activities have a greater chance of dispersal along the predominant wind direction and affect the downwind human habitations. The monitoring network for ambient air quality was developed based on the following key criteria:

- (i) Regional meteorology (primarily wind speed and direction);
- (ii) Important receptor locations (e.g. nearby inhabitation);
- (iii) Proposed project activities; and
- (iv) Logistics for operating the air monitoring equipment.

272. The predominant wind directions in Maldives are dependent on the NE and SW monsoons. The wind directions for all seasons recorded at the National Meteorological Centre, Maldives reveal that apart from the winter months (when winds primarily blow from NW-NE), winds predominantly blow from the west.

273. The exact location of the ambient air stations was selected by PMU through its consultant, Water Solutions / Kocks, to ensure the locations experience free air flow and are established at height between 1.5 – 5 meters. Because of the location of the island, strong gusts and variations of wind directions were noted which have the potential to influence the dispersion and in turn affect the air sampling. Therefore, the sampling activities took into consideration and systematically recorded wind directions and strong gusts. The rationale for selecting the four sampling stations are summarized in Table 18 below.

**Table 18: Summary and Description of Selected Ambient Air Monitoring Stations**

Station Name	Station Coordinates	Rationale of Location Selection
Thilafushi Downwind (AQ1)	4°10'56.6 N 73°26'53.3 E	This downwind station with respect to the proposed facility has been selected to establish the baseline that could be compared with the monitoring to be undertaken during the construction and operational phases of the project to detect actual project imprints to the air quality of the nearest receptor.
Thilafushi crosswind (AQ2)	4°10'57.3 N 73°25'59.4 E	The crosswind station with respect to the proposed facility has been selected to establish the general baseline of the island, for comparison with the downwind station at the time of project activities
Thilafushi crosswind (AQ3)	4°11'07.6 N 73°26'37.4 E	The crosswind station with respect to the existing dumpsite at the Thilafushi has been selected to establish the general baseline of the island
Vilingili Island (AQ4)	4°10'26.4 N 73°28'59.9 E	The crosswind station with respect to Thilafushi has been selected as a control site and to detect project imprints to air quality of the nearest receptor due to trans-island transportation of pollutants

274. **Ambient Air Quality Sampling Instrument.** The instruments used for taking air quality reading are the Aeroqual series 500 monitors and sensors. Aeroqual is a portable handheld monitor suited for surveying common indoor and outdoor pollutants compatible with over 30 different sensors. The Series 500 can be deployed for short term fixed monitoring by adding an optional outdoor enclosure. The Aeroqual Series 500 is also highlighted as the leading instrument for measuring ozone, nitrogen dioxide and carbon monoxide by the United States Environmental Protection Agency (US EPA).

275. **Results of Baseline Ambient Air Quality Monitoring.** On each sampling day, 1 set of 24-hour average samples were collected continuously. PM<sub>10</sub>, PM<sub>2.5</sub>, Sulfur dioxide (SO<sub>2</sub>) and Oxides of nitrogen (NO<sub>x</sub>) were measured continuously during the sampling period. **Table 19** below shows the readings for all parameters.

**Table 19: Results of Baseline Ambient Air Quality Monitoring at Selected Locations**

Reading Description	Parameters / Results <sup>a</sup>			
	PM10	PM2.5	SO2	NO2
	µg/m3	µg/m3	µg/m3	µg/m3
<b>Thilafushi Downwind (AQ-1) (19 - 25 March 2019)</b>				
Minimum	7.0	8.0	5.0	0
Maximum	427.0	384.0	72.0	87.0
Mean	<b>26.5</b>	<b>26.9</b>	<b>25.3</b>	<b>59.5</b>
99th Percentile	147.0	122.0	76.0	78.0
<b>Thilafushi Crosswind (AQ-2) (20 - 25 August 2019)</b>				
Minimum	8.0	5.0	0.0	49.0
Maximum	134	112	18.5	65.0
Mean	<b>19.3</b>	<b>12.1</b>	<b>9.8</b>	<b>56.0</b>
99th Percentile	37.6	24.6	16.5	60.0
<b>Thilafushi Downwind (AQ-3) (25 - 31 August 2019)</b>				
Minimum	4.0	1.0	2.0	53.0
Maximum	690.0	362.0	112.2	81.0
Mean	<b>88.4</b>	<b>42.8</b>	<b>32.4</b>	<b>64.9</b>
99th Percentile	281.0	85.4	40.3	72.1
<b>Vilingili Island (AQ-4) (3 - 9 March 2019)</b>				
Minimum	13.0	22.7	2.0	2.0
Maximum	41.0	41.0	19.0	87.0

Reading Description	Parameters / Results <sup>a</sup>			
	PM10	PM2.5	SO2	NO2
	µg/m <sup>3</sup>	µg/m <sup>3</sup>	µg/m <sup>3</sup>	µg/m <sup>3</sup>
Mean	22.7	22.1	7.6	60.6
99th Percentile	32.0	32.0	2.0	70.8
<b>WHO Standard (µg/m<sup>3</sup>)</b>	<b>50.0<sup>a</sup></b>	<b>25.0<sup>a</sup></b>	<b>20.0<sup>a</sup></b>	<b>200.0<sup>b</sup></b> <b>40.0<sup>c</sup></b>

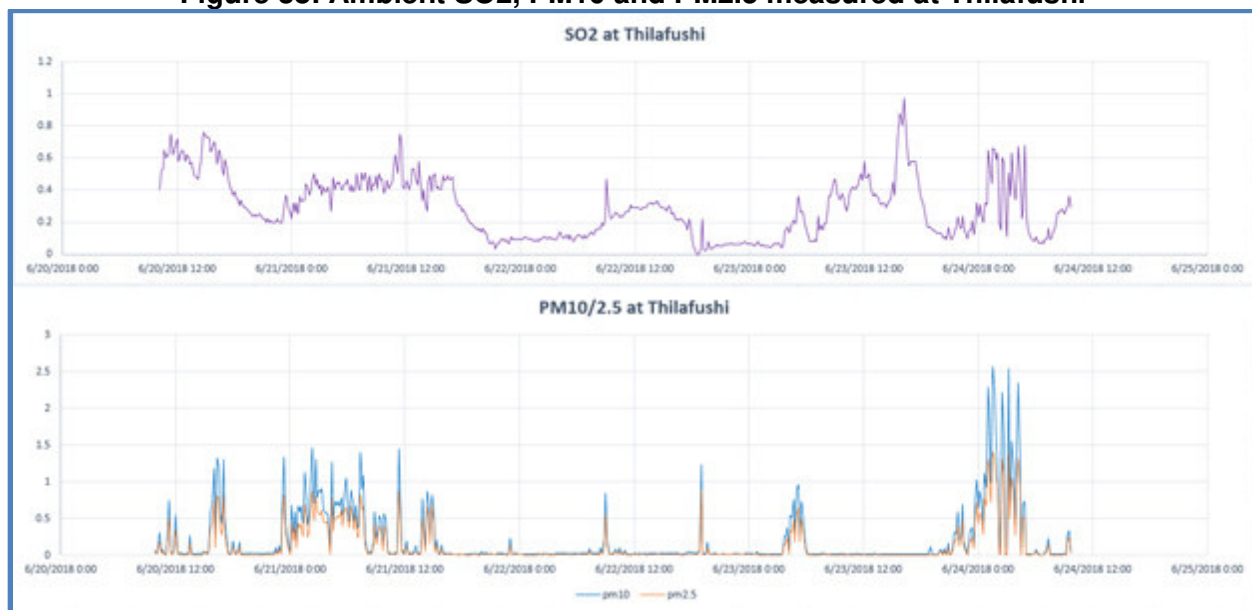
<sup>a</sup> Based on 24-hour averaging period; <sup>b</sup> Based on 1-hour averaging period; <sup>c</sup> Based on 1-year averaging period

276. Ambient air quality results obtained from the monitoring undertaken indicate that mixed results when compared with the WHO guidelines for ambient air quality.

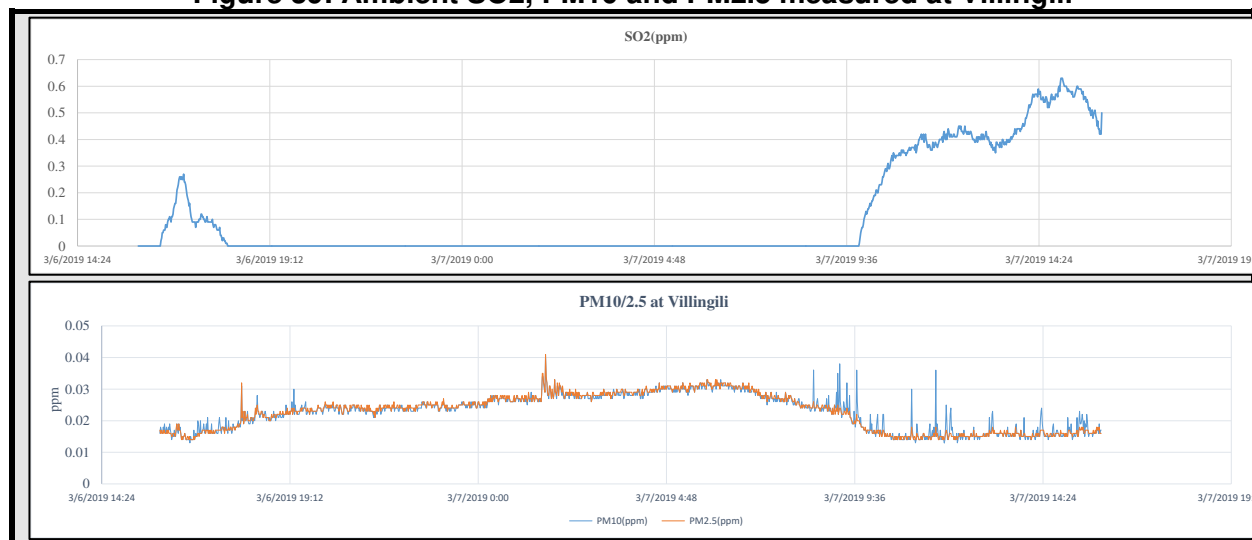
- (i) The 24 hourly PM10 values recorded for the stations generally varied in the range of 4.0 - 690.0 µg/m<sup>3</sup>. The mean values of PM10 recorded at AQ1, AQ2 and AQ4 were found to be in compliance with the WHO standard specified for such pollutant equivalent to 50 µg/m<sup>3</sup>. However, the mean value of PM10 recorded at AQ3 is 88.4 µg/m<sup>3</sup>, which exceeds WHO standard specified for such pollutant equivalent to 50 µg/m<sup>3</sup>.
- (ii) The 24 hourly PM2.5 values recorded for the stations generally varied in the range of 1.0 - 384.0 µg/m<sup>3</sup>. The mean values for PM2.5 at AQ2 and AQ4 were found to be in compliance with the WHO standard specified for such pollutant equivalent to 25 µg/m<sup>3</sup>. However, mean values for PM2.5 at AQ1 and AQ3 are 26.9 µg/m<sup>3</sup> and 42.8 µg/m<sup>3</sup>, respectively, which exceed WHO standard specified for such pollutant equivalent to 25 µg/m<sup>3</sup>.
- (iii) The 24 hourly SO2 values recorded for the stations generally varied in the range of 0.0 - 112.2 µg/m<sup>3</sup>. The mean values for SO2 at AQ2 and AQ4 were found to be in compliance with the WHO standard specified for such pollutant equivalent to 20 µg/m<sup>3</sup>. However, mean values for SO2 at AQ1 and AQ3 are 25.3 µg/m<sup>3</sup> and 32.4 µg/m<sup>3</sup>, respectively, which exceed WHO standard specified for such pollutant equivalent to 20 µg/m<sup>3</sup>.
- (iv) The results of the 24-hourly standard values for NO2 have not been compared. WHO standards does not provide 24-hourly standard for NO2 to check for any possible non-compliances. However, if compared with the hourly averaging, the values are below the WHO standard of 200 µg/m<sup>3</sup>.

277. Based on field visits and visual observations, the non-compliances for various parameters at different sampling locations in Thilafushi may be attributed to the continuous and instantaneous burning of wastes at the existing dumpsite. The government plans to stop fires on Thilafushi and start baling waste by July 2020 as interim SWM solution to stop open dumping until the WTE facility is commissioned. It is expected that once these measures are implemented the air quality at the sampling locations will improve.

**Figure 38: Ambient SO<sub>2</sub>, PM<sub>10</sub> and PM<sub>2.5</sub> measured at Thilafushi**



**Figure 39: Ambient SO<sub>2</sub>, PM<sub>10</sub> and PM<sub>2.5</sub> measured at Villingili**



278. Monthly ambient air quality data gathering in Thilafushi shall be undertaken strategically during the design phase of the project. The DBO Contractor shall:

- (i) undertake ambient air quality measurements for each season of the year at the identified sampling locations in this EIA report (and any other locations in the Thilafushi island as may be deemed by the DBO Contractor as important sampling locations);
- (ii) follow required sampling methodology and averaging time as indicated in the WHO Ambient Air Quality Guidelines; and
- (iii) include results of analyses in the updating of the EIA during the detailed design phase.

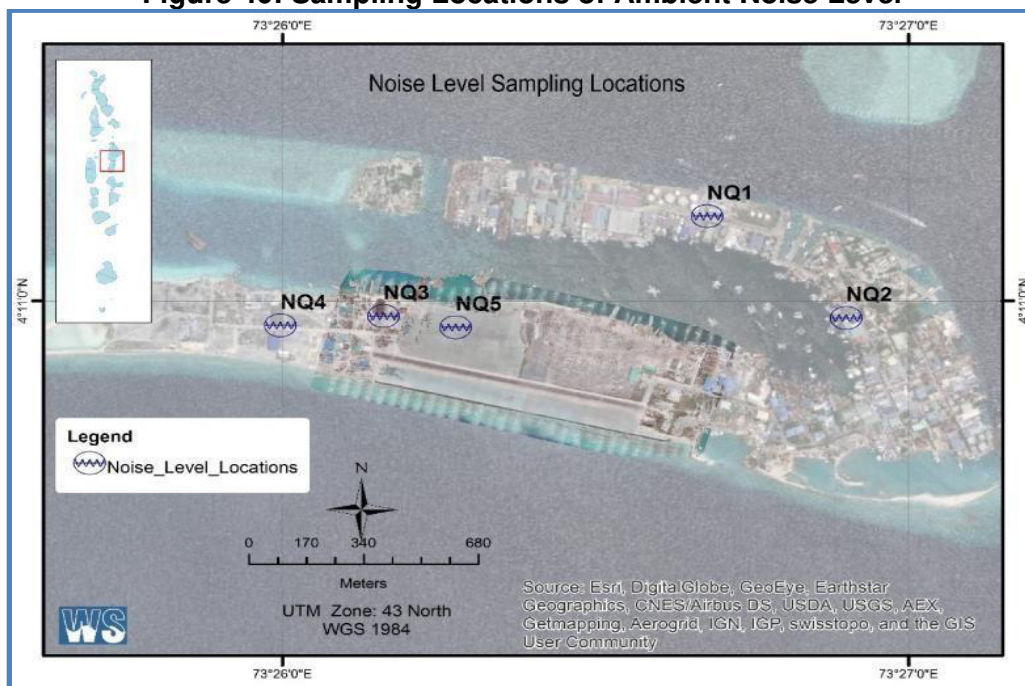
### 3. Noise Level

279. Ambient noise levels were measured to establish baseline at five locations in Thilafushi. The measurement was done using handheld sound level meter. Measurements were conducted during the day time from 10:00 am to 12:00 pm and during the night from 10:00 pm to 12:00 pm. The day time was considered as 7:00 a.m. to 10:00 p.m., while the night time was considered as 10:00 p.m. to 7:00am. Another set of measurements were conducted at the two nearest receptors on hourly basis for 24 hours. Table 20 summarizes the explanation on the selection of baseline monitoring stations. Figure 40 is the map that shows the sampling locations.

**Table 20: Rationale in the Selection of Locations for Ambient Noise Level Measurements**

Station Name	Station Coordinates	Monitoring Rationale
NQ1 (Thilafushi)	4°10'26.4 N 73°28'59.9 E	The station was selected as it represents a major industrial location of the island and is also located close to the harbor. The location lies north of the proposed facility on the opposite side of the lagoon.
NQ2 (Thilafushi)	4°10'56.6 N 73°26'53.3 E	The station was selected as it represents a major industrial location of the island. The location lies east of the proposed facility on the opposite side of the lagoon. The location has various industrial activities in its proximity
NQ3 (Thilafushi)	4°10'58.3 N 73°26'09.6 E	This station was selected as it is located near the boundary of the proposed WTE facility.
NQ4 (Thilafushi)	4°10'57.3 N 73°25'59.4 E	This station was selected as it is located west of proposed WTE facility. The area has less development and less activity during the day time.
NQ5 (Thilafushi)	4°10'57.3 N 73°26'14.4 E	This station was selected as it is located at the proposed WTE facility.

**Figure 40: Sampling Locations of Ambient Noise Level**





280. **Results.** There is high background noise in Thilafushi, which can be attributed to the roar from the sea, windy conditions and closely packed industrial areas and movement of boats. Thilafushi is quieter during the night as there are no activity on the island. The ambient noise levels comply with WHO Guideline Values for commercial and industrial locations. Table 21 shows the summary of noise level measurements during the day time from 10:00 am to 12:00 pm and during the night from 10:00 pm to 12:00 pm, while Table 22 shows the summary of noise level measurements at nearest potential receptors conducted hourly for 24 hours. The complete report on noise level measurements is in Appendix 9.

**Table 21: Summary of Noise Level Measurements During Day Time and Night Time**

S. No	Locations	Noise Level dB (A) Day Time	Noise Level dB (A) Night Time
NQ1	Thilafushi (25 August 2019)	65.1	58.7
NQ2	Thilafushi (25 August 2019)	64.2	51.8
NQ3	Thilafushi (25 August 2019)	56.3	50.0
NQ4	Thilafushi (25 August 2019)	56.0	48.9
NQ5	Thilafushi (25 August 2019)	54.6	49.0
WHO Guideline Values for Ambient Noise Level		70	70

**Table 22: Summary of Noise Level Measurements at Nearest Receptors (24 hours)**

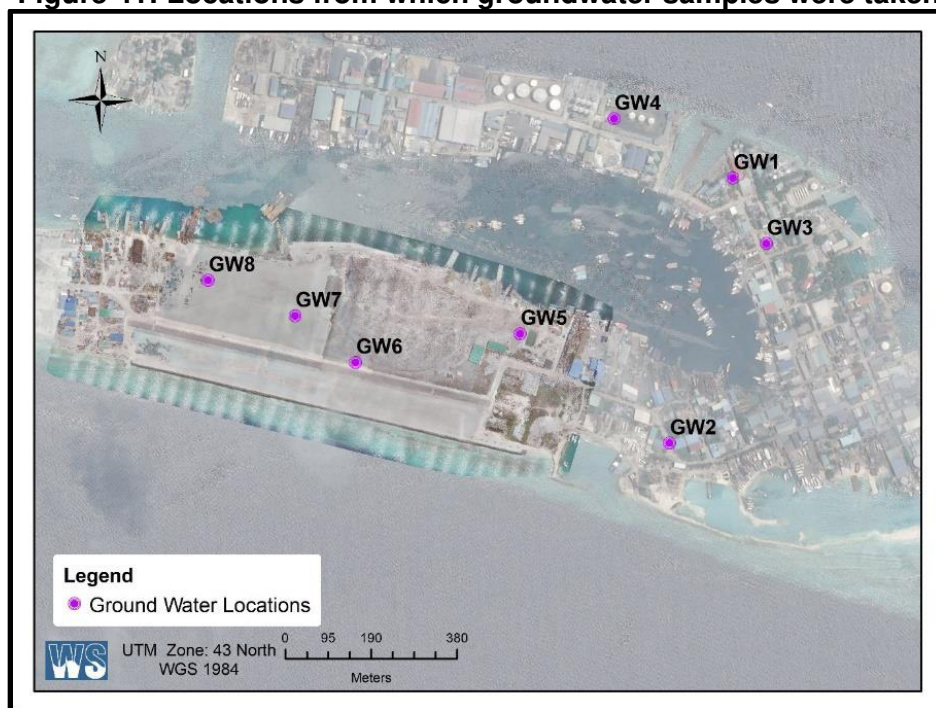
Date	Time	Noise Level dB (A)	
		NQ3	NQ4
6/10/2019	7:00	50.1	52.4
6/10/2019	8:00	54.4	54.3
6/10/2019	9:00	55.7	56.2
6/10/2019	10:00	56.5	56.8
6/10/2019	11:00	57.1	55.4
6/10/2019	12:00	56.8	57.4
6/10/2019	13:00	57.4	56.4
6/10/2019	14:00	57.3	55.9
6/10/2019	15:00	56.7	55.4
6/10/2019	16:00	56.8	56.1
6/10/2019	17:00	51.3	54.3
6/10/2019	18:00	49.4	49.4
6/10/2019	19:00	50.1	48.9
6/10/2019	20:00	49.6	48.6

		Noise Level dB (A)	
Date	Time	NQ3	NQ4
6/10/2019	21:00	49.3	48.3
6/10/2019	22:00	50.1	48.5
6/10/2019	23:00	50.3	48.3
7/10/2019	0:00	50.1	48.1
7/10/2019	1:00	50.1	48.1
7/10/2019	2:00	50.3	48.3
7/10/2019	3:00	50.8	47.8
7/10/2019	4:00	50.2	48
7/10/2019	5:00	49.5	49.1
7/10/2019	6:00	49.8	49.3

#### 4. Groundwater Quality

281. On 2 April 2019, groundwater samples were collected from eight wells in Thilafushi. See Figure 41 below for the locations of these wells. These wells include 4 old wells (GW1 – GW4) and 4 freshly dug wells (GW5 – GW8).

**Figure 41: Locations from which groundwater samples were taken**



282. For each location, the samples were collected from mid-water level in clean two 500 ml PET bottles and one 250 ml glass bottle, after rinsing with water from the sampling points. For microbial tests, samples were collected in 300 ml sterile bags.

283. Samples for microbiology testing were stored in an icebox and transferred to MWSC Quality Assurance Laboratory for testing. Other samples were sent to Sri Lanka (at Bureau Veritas laboratory) for testing. All groundwater samples were tested for Conductivity, pH, Salinity, Temperature, Turbidity, Chloride, Total Dissolved Solids (TDS), Total Coliform, heavy metals (As, Mn, Fe, Pb, Hg, Cd), Ammonia, Nitrates, Oil, Grease and Polynuclear Aromatic Hydrocarbons (PAH). The results of these laboratory tests are shown below in Table 23. Copies of laboratory analyses are in Appendix 10.

284. Based on analysis, water samples collected did not comply with parameters on coliform, total dissolved solids, iron, and manganese based on the National Drinking Water Quality Standards (NDWQS). Therefore, if not treated, the groundwater is not an acceptable source of drinking water.

285. Additional groundwater quality monitoring and sampling activities shall be undertaken by the DBO Contractor during the detailed design phase of the project to establish better and more robust baseline data. The DBO Contractor shall include results of laboratory analyses from these groundwater sampling activities in the updating of the EIA report during the detailed design phase.

Table 23: Groundwater Quality Test Results

Parameters	Results								LoQ	Unit	Test Method
	GW1	GW2	GW3	GW4	GW5	GW6	GW7	GW8			
Physical Appearance	Clear	Pale brown with particles	Pale yellow with particles	Pale yellow with particles	Olive green with particles	Olive green with particles	Yellow with particles	Cloudy and opaque	-	-	-
Chloride	183	1715	7200	470	3125	6325	6125	1005	-	mg/l	In-house Method (Adapted from M926 Chloride analyzer)
Nitrate*	1.7	6.1	5	7.5	25.5	34.5	12.2	3.4	-	mg/l	Method 8171(Adapted from HACH DR5000)
Phosphate*	0.07	0.23	0.21	<0.05(Lo Q)	0.46	0.57	2.27	0.72	0.05	mg/l	Method 8048(Adapted from HACH DR5000)
Total Coliforms	>2420	291	>2420	1986	>2420	10	>2420	4	-	mg/l	Colilert®-18/Quantit-Tray®2000
Turbidity*	1.3	4	0.6	0.4	151	177	1845	348	-	NTU	APHA 23rd ed: 2017: 2130 B
pH at 25°C*	7.3	7.2	7.4	8	7.1	6.7	7.9	7.8	-	mg/l	APHA 23rd ed: 2017 :4500H+
Iron (as Fe) *	0.4	3.9	0.6	ND	5.9	5.7	0.7	0.4	-	mg/l	APHA 23rd ed: 2017: 3125 B
Manganese (as Mn)	0.02	0.09	0.006	ND	0.2	0.3	0.01	0.07	-	mg/l	APHA 23rd ed: 2017: 3125 B
Arsenic (as As)	ND	ND	ND	ND	ND	ND	ND	ND	0.001	mg/l	APHA 23rd ed: 2017: 3125 B
Total Dissolved Solids*	794	4020	12946	1003	6155	11554	11327	2188	-	mg/l	APHA 23rd ed: 2017: 2540 C
Electrical Conductivity at 25°C*	1.39	7.39	20.6	1.87	12.3	25	18.7	3.8	-	mS/cm	APHA 23rd ed: 2017: 2510 B
Cadmium (as Cd)*	ND	ND	ND	ND	ND	ND	ND	ND	0.0001	mg/l	APHA 23rd ed: 2017: 3125 B
Lead (as Pb)"	ND	ND	ND	ND	ND	ND	ND	ND	0.001	mg/l	APHA 23rd ed: 2017: 3125 B
Mercury (as Hg)	ND	ND	ND	ND	ND	ND	ND	ND	0.00005	mg/l	APHA 23rd ed: 2017: 3125 B
<b>Polynuclear Aromatic Hydrocarbons*</b>											
Naphthalene	ND	ND	ND	ND	ND	ND	ND	ND	1	µg/l	CPSD -AN-00576

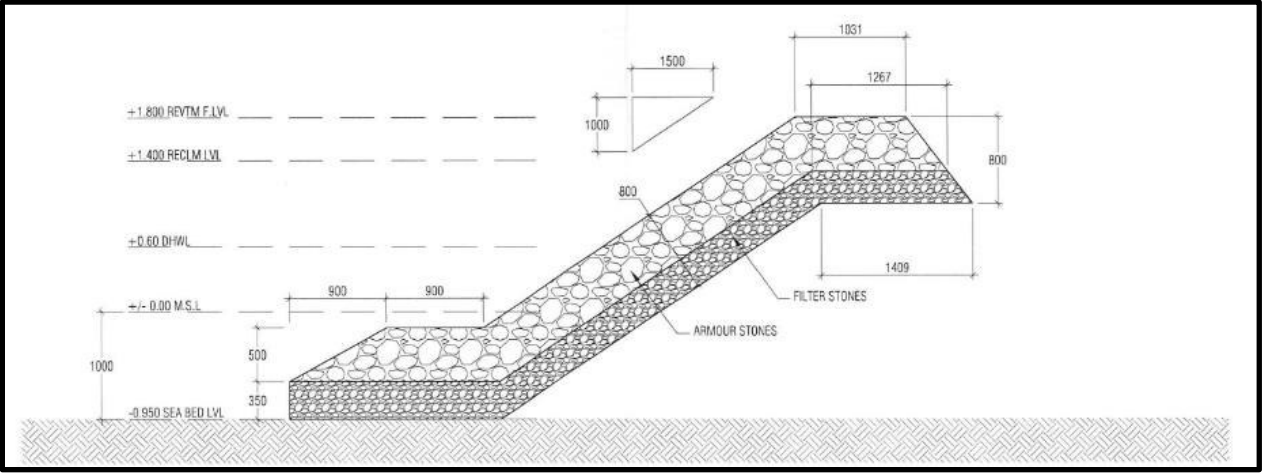
Parameters	Results								LoQ	Unit	Test Method
	GW1	GW2	GW3	GW4	GW5	GW6	GW7	GW8			
Acenaphthylene	ND	ND	ND	ND	ND	ND	ND	ND	1	µg/l	CPSD -AN-00576
Acenaphthene	ND	ND	ND	ND	ND	ND	ND	ND	1	µg/l	CPSD -AN-00576
Fluorene	ND	ND	ND	ND	ND	ND	ND	ND	1	µg/l	CPSD -AN-00576
Phenanthrene	ND	ND	ND	ND	ND	ND	ND	ND	1	µg/l	CPSD -AN-00576
Anthracene	ND	ND	ND	ND	ND	ND	ND	ND	1	µg/l	CPSD-AN-00576
Fluoranthene	ND	ND	ND	ND	ND	ND	ND	ND	1	µg/l	CPSD -AN-00576
Pyrene	ND	ND	ND	ND	ND	ND	ND	ND	1	µg/l	CPSD -AN-00576
Benzo[ a] anthracene	ND	ND	ND	ND	ND	ND	ND	ND	1	µg/l	CPSD -AN-00576
Chrysene	ND	ND	ND	ND	ND	ND	ND	ND	1	µg/l	CPSD -AN-00576
Benzo[a]pyrene	ND	ND	ND	ND	ND	ND	ND	ND	1	µg/l	CPSD -AN-00576
Benzo[e]pyrene	ND	ND	ND	ND	ND	ND	ND	ND	1	µg/l	CPSD -AN-00576
Indeno[ 1,2,3-cd]pyrene	ND	ND	ND	ND	ND	ND	ND	ND	1	µg/l	CPSD -AN-00576
Dibenzo [a,h ]anthracene	ND	ND	ND	ND	ND	ND	ND	ND	1	µg/l	CPSD -AN-00576
Benzo[g,h,i]perylene	ND	ND	ND	ND	ND	ND	ND	ND	1	µg/l	CPSD -AN-00576
Benzo[b ]fluoranthene	ND	ND	ND	ND	ND	ND	ND	ND	1	µg/l	CPSD -AN-00576
Benzo[j]fluoranthene	ND	ND	ND	ND	ND	ND	ND	ND	1	µg/l	CPSD -AN-00576
Benzo[k]fluoranthene	ND	ND	ND	ND	ND	ND	ND	ND	1	µg/l	CPSD -AN-00576

**D. Coastal Environment**

286. The coastal environment of the proposed site for the development RWMF is protected by coastal protection structures. 877 m long rock boulder revetment has been constructed on southern side to protect the reclaimed land while on northern side of the reclaimed land is protected with a 911 m long concrete quay wall. A section of the rock boulder revetment is shown in Figure 42 and Figure 43 shows the cross section of the quay wall.

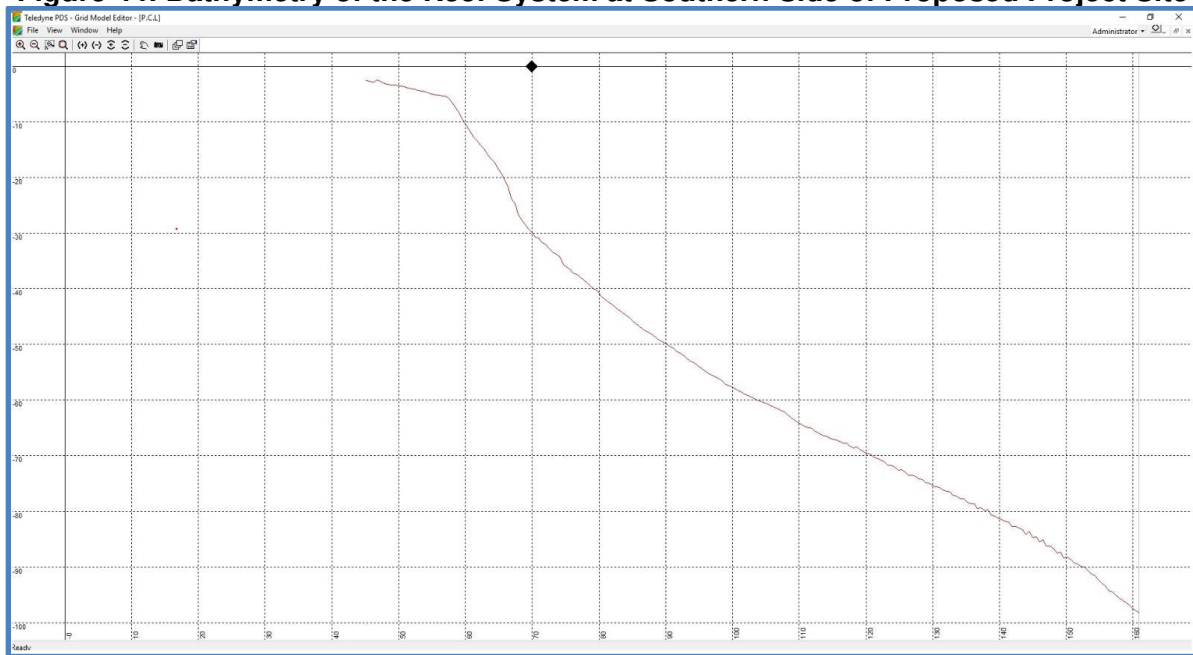
287. The revetment runs from the seafloor about -1m MSL to the crest level at MSL +1.8m. The slope of the revetment is 1 in 2 with rock boulders.

**Figure 42: Design details of the rock revetment protecting the southern side of the reclaimed land**



288. The quay walls are constructed with prefabricated reinforced concrete elements which are placed on the boundary of the reclaimed area. The elements are coupled by a capping beam as shown in Figure 43.



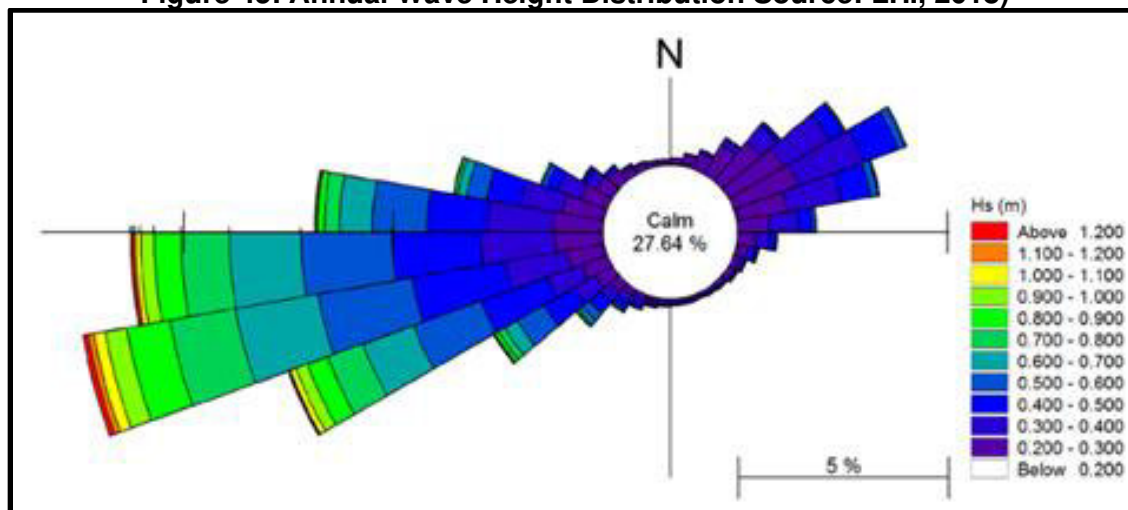
**Figure 44: Bathymetry of the Reef System at Southern Side of Proposed Project Site**

## 2. Hydrology

290. **Wave.** Two major types of waves have been reported on the coasts of the Maldives: waves generated by local monsoon wind and swells generated by distance storms. The local monsoon predominantly generates wind waves which are typically strongest during April-July in the southwest monsoon period. During this season, swells generated north of the equator with heights of 2-3 m sustained for periods of 18-20 seconds have been reported in the region. Local wave periods are generally in the range 2-4 seconds and are easily distinguished from the swell waves. Thilafushi Island is exposed to wind generated waves during NE monsoon and during transition periods. It is also expected to experience swell waves throughout the year. The southern side is likely to experience residual swell waves approaching from the South west and direct swell waves approaching from the SE (Naseer, 2003). LHI (2018) reported maximum significant wave height observed was over 1.2 m based on the field measurements that were taken in the Thilafushi reef system. Figure 45 graphically illustrate the wave height distribution pattern in terms of direction, occurrence and height.



**Figure 45: Annual Wave Height Distribution Source: LHI, 2018)**

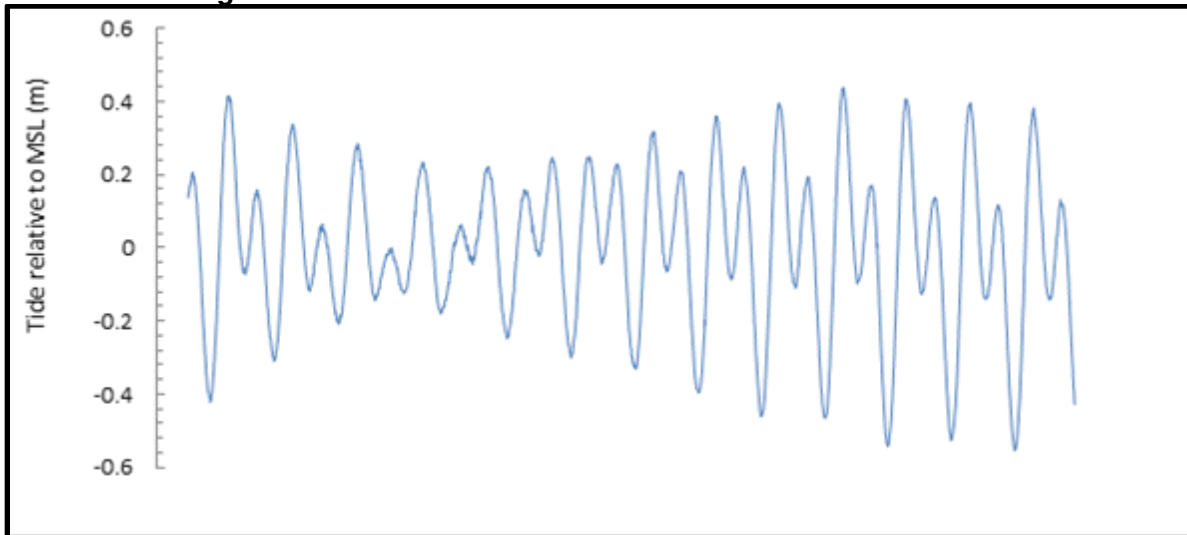


291. Distant cyclones and low-pressure systems originating from the intense South Indian Ocean storms are reported to generate long distance swells that occasionally cause flooding in the Maldives. The swell waves that reached Malé and Hulhule in 1987 are thought to have originated from a low-pressure system off the west coast of Australia and had significant wave heights in the order of 3 meters.

292. In addition, the Maldives have been subject to earthquake generated tsunami reaching heights of 4.0m on land (UNEP, 2005). Historical wave data from the Indian Ocean countries show that tsunamis have occurred in more than 1 occasion, most notable been the 1883 tsunami resulting from the volcanic explosion of Krakatoa (Choi and others, 2003) as well as the Indian Ocean tsunami of 2004.

293. The proposed site is located away from the ocean-ward side and protected on the atoll lagoon with the presence of land. The proposed land for the development of the RWMF is unlikely to be affected by wave activity provided the proposed coastal protection measures for the reclaimed land would be undertaken as planned.

294. **Tide.** The tide observed in Maldives can be classified as a mixed diurnal tide. The tidal variations are small and the average tidal range in Maldives is approximately 1 m (MEE, 2016). The variations of the tidal levels for the respective stations are given in the Figure 46. Tide affects wave conditions, wave generated and other reef-top currents. Tide levels are believed to be significant in controlling the amount of wave energy reaching the island, as no wave energy crosses the edge of the reef at low tide under normal conditions. In the Maldives where the tidal range is small (1 m), tides may have significantly important influence on the formation, development and sediment movement process around the island tides also may play an important role in lagoon flushing, water circulation within the reef and water residence time within an enclosed reef highly depends on tidal fluctuations.

**Figure 46: Tide observed in Malé is mixed diurnal in nature**

295. Tide data is important information in any coastal development project as it determines the elevation of the structures relative to a datum. A permanent tidal record station has been established at Velana International Airport by Maldives Meteorological Service. The maximum tidal range recorded at this tide station is 1.2m. The highest astronomical tide level is +0.62m (MSL) and lowest astronomical tide level is -0.72m MSL. The following table gives a summary of the tide levels for the tide datum has been widely used in Maldives.

**Table 24: Summary of the Tide Levels Hulhule Island, Male Atoll**

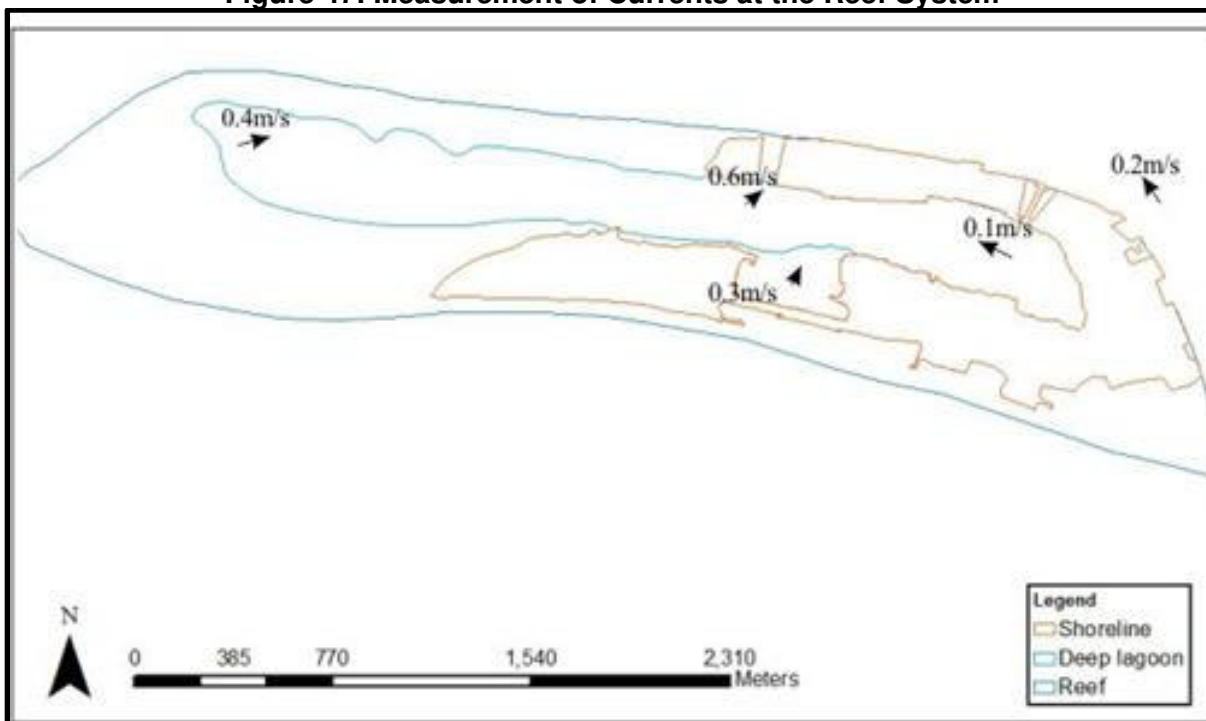
Water level from MSL (m)	Malé (2007-2011)
Highest High water (HHW)	0.62
Mean Highest High water (MHHW)	0.34
Mean High water (MHW)	0.33
Mean Low water (MLW)	-0.36
Mean Lowest Low water (MLLW)	-0.37
Lowest Low water (LLW)	-0.72

Source: MEE (2016).

296. **Surface Currents.** Currents that affect the reef system of Thilafushi can be caused by tidal currents, wind-induced currents and wave-induced currents. Generally current flow through the country is defined by the two-monsoon season winds. Westward flowing currents are dominant from January to March with the change in current flow pattern taking place in April and December. In April the westward currents become weak while the eastward currents start to take over. In December the eastward currents are weak with the westward currents becoming more prominent. Hence, currents within the site are very likely to be heavily influenced by the monsoons.

297. Current measurements were undertaken on the island in June 2017 during the field assessment phase. Generally, long term studies are required to establish the prevailing site-specific current patterns. However, due to time limitations of the present study a snapshot assessment was undertaken using drogue technique. The findings of the measurements are presented in Figure 47.

**Figure 47: Measurement of Currents at the Reef System**



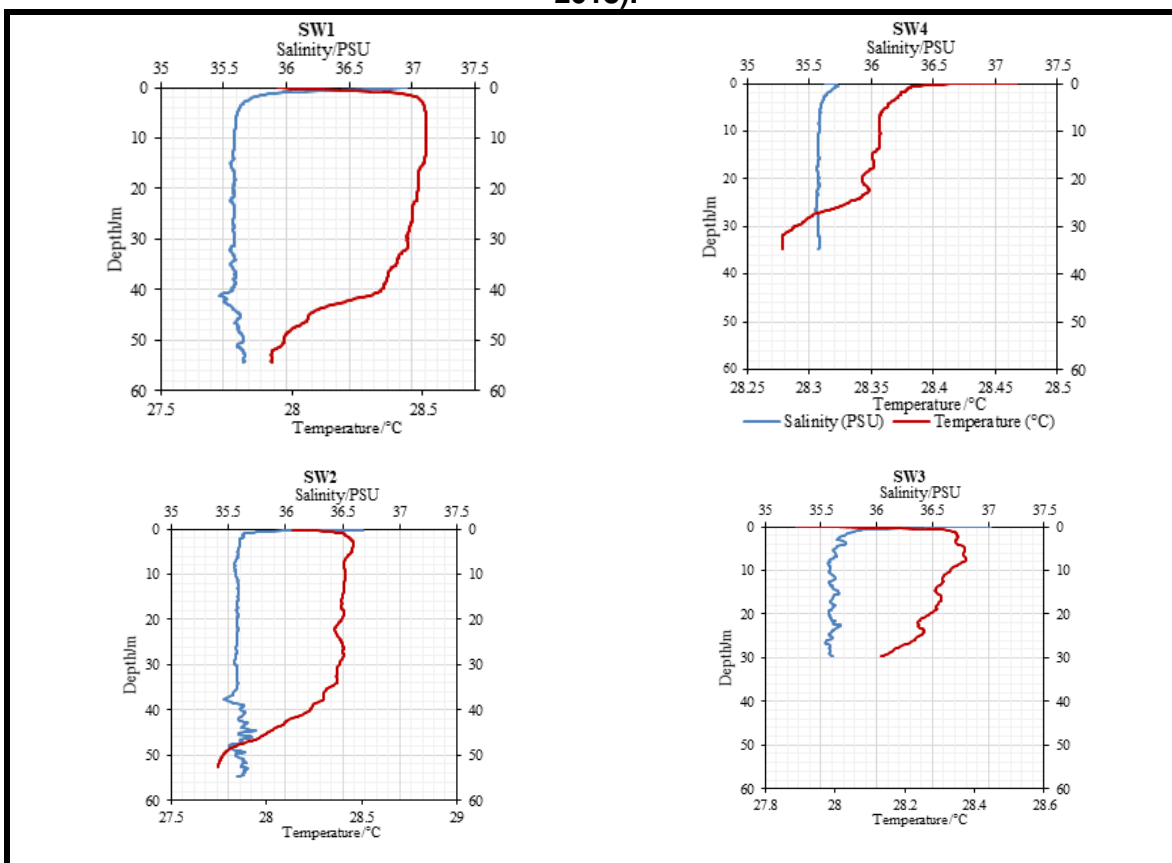
298. The open ocean currents were generally slow during flood and ebb tides but increased closer to the Thilafushi channel during the flood tide. Current speeds within the lagoon showed a consistent average speed between 0.1 - 0.2 m/s. This was mainly due to the blocked nature of the inner lagoon. The speed increased an average of 0.3 m/s close to the Thilafushi Channel.

299. **Sea Surface Salinity and Sea Surface Temperature.** Sea Surface Temperatures (SST) of Malé region, based on satellite derived measurements, generally vary between 28 and 29 (Singh et al, 2001). It was also reported in Addu Atoll (Stoddart, 1966). Singh et al. (2001) reported that there has been a gradual increase in SST in the order of +1.6°C per decade along the central regions of the Maldives. Salinity measurements in the open ocean and within the atoll lagoon of Maldives usually range between 33 - 35‰ (Stoddart, 1966). However, there is a slight salinity gradient observed on the reef flat, especially from the island coastline to the reef edge. This gradient is highest following heavy rainfall (Stoddart, 1966).

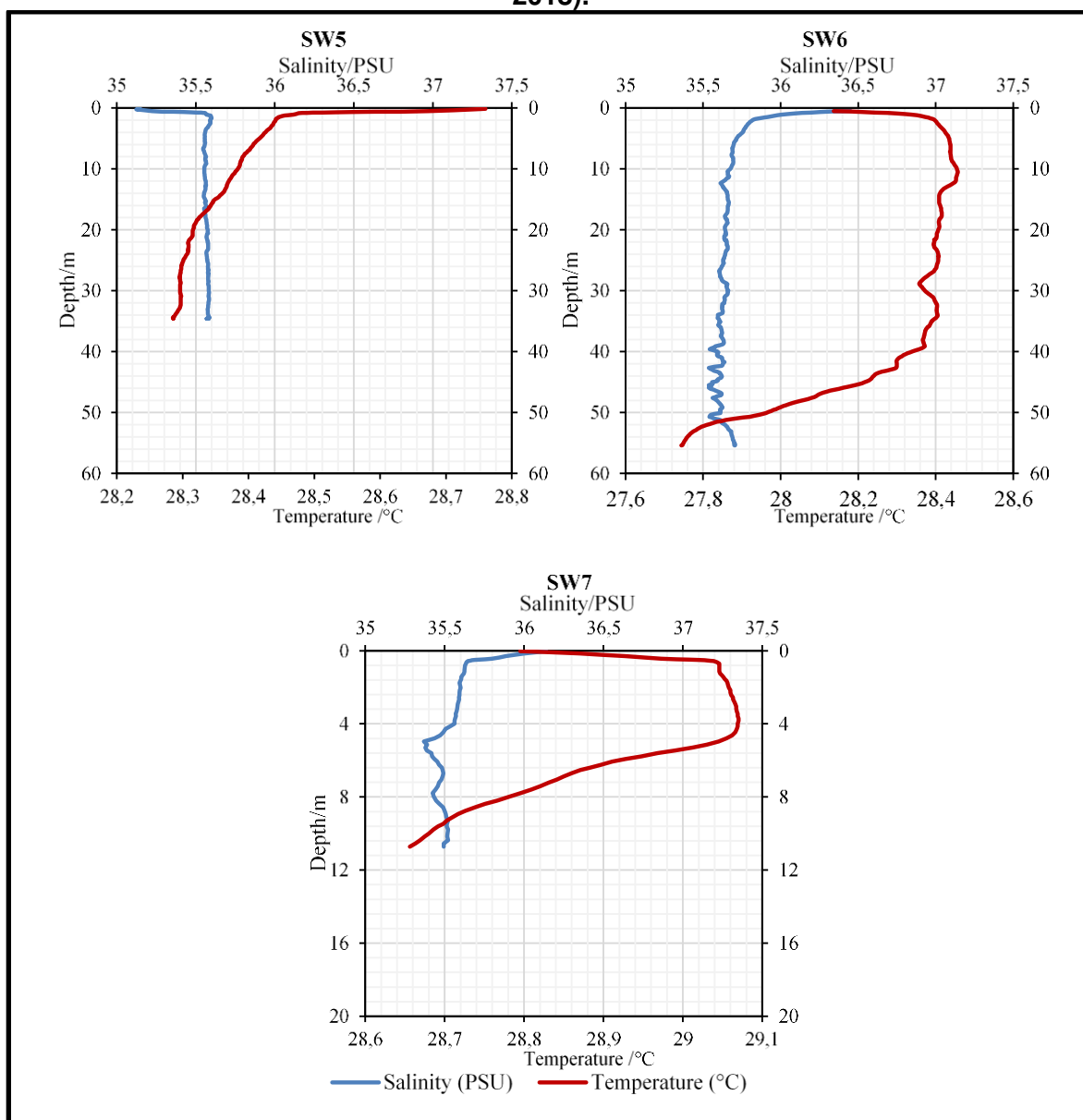
300. The results of the field assessment for SST and Salinity by CDE (2011) reported that the temperature values recorded were uniform across the sampling sites and depths in Thilafushi reef system. Slight variations in the salinity were observed between the outer reef and inner lagoon. The salinity was reported at 30.5 ‰ while the temperature was 23.1 °C.

301. For the purpose of EIA, in situ testing was carried out for temperature and salinity changes at depth with the use of a Valeport mini sound velocity profiler (SVP). Although the SVP is designed to measure sound velocity with depth, the device also records temperature and computes salinity. As a result, it is possible to obtain conductivity, temperature and depth (CTD) profiles from the SVP. The purpose of the use of SVP's was to determine the temperature and salinity fluctuations within the first 30 meters of the water column. The figures below outline the CTP profiles taken from the SVP.

Figure 48: CTD profiles obtained from water sample locations (SW1–SW4) (3rd July 2018).



**Figure 49: CTD profiles obtained from water sample locations (SW5 – SW7) (3rd July 2018).**

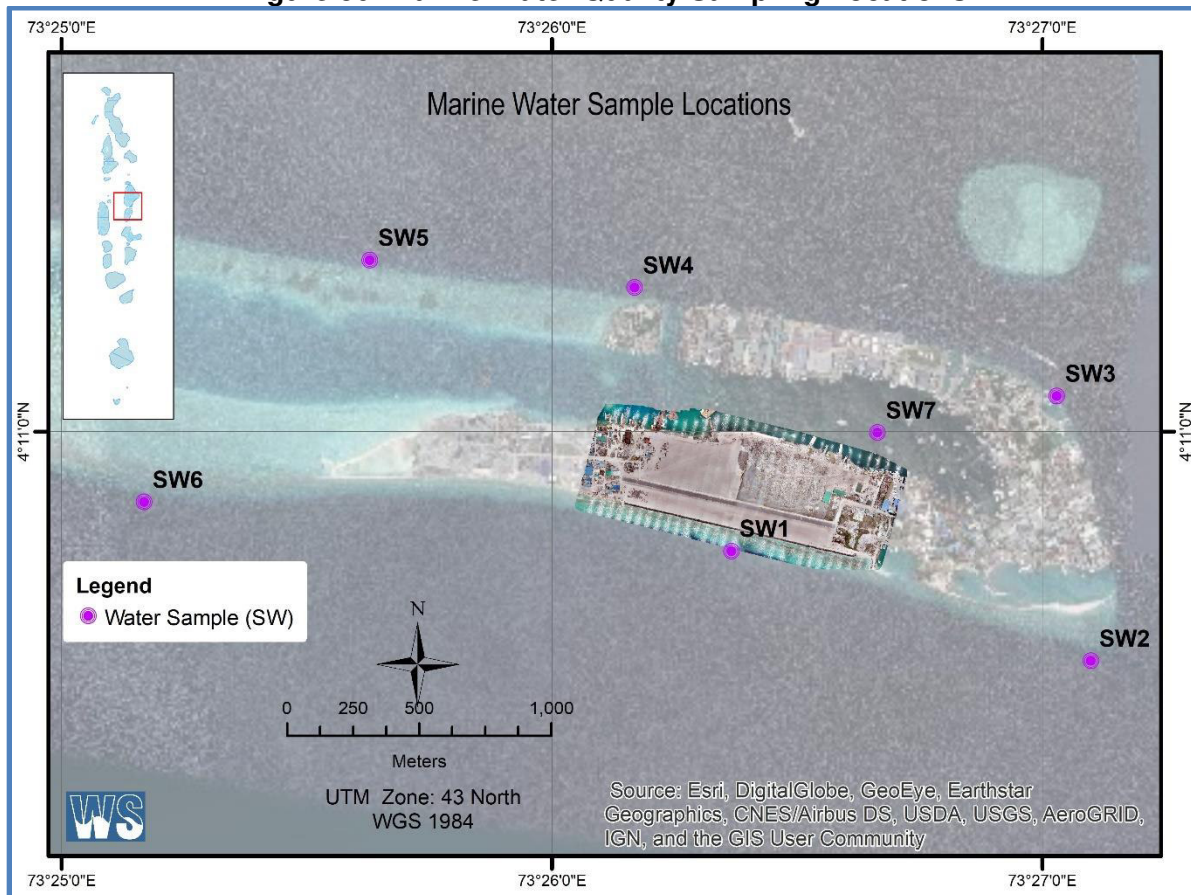


302. **Marine water quality.** The primary objective of the marine water quality sampling was to determine the baseline conditions of the marine water around the project area. Qualitative and quantitative assessments were made on seawater from sites SW1 – SW7. Laboratory analysis were done for heavy metals (As, Cr, Cu, Ni, Pb, Zn, Hg, Cd), Ammonia, nitrates, PH, Turbidity, Oil and Grease and BOD. BOD was analyzed in MWSC, Malé. The remainder of the parameters were tested at Bureau Veritas laboratory, Sri Lanka. The table below outlines the results of the laboratory tests. These results show compliance with the Maldives Marine Monitoring Standards. Copies of the laboratory analyses are consolidated in Appendix 11.

303. Quarterly marine water quality data gathering at these sampling locations or sites shall be undertaken strategically during the design phase of the project. The DBO Contractor shall:

- (i) undertake marine water quality measurements for each season of the year at the identified sampling locations or sites used in this EIA report (and any other locations as may be deemed by the DBO Contractor as important sampling locations or sites);
- (ii) follow required sampling methodology per requirements of the Maldives EPA; and
- (iii) include results of analyses in the updating of the EIA during the detailed design phase.

**Figure 50: Marine Water Quality Sampling Locations**



**Table 25: Water quality results from sites SW1 to SW7**

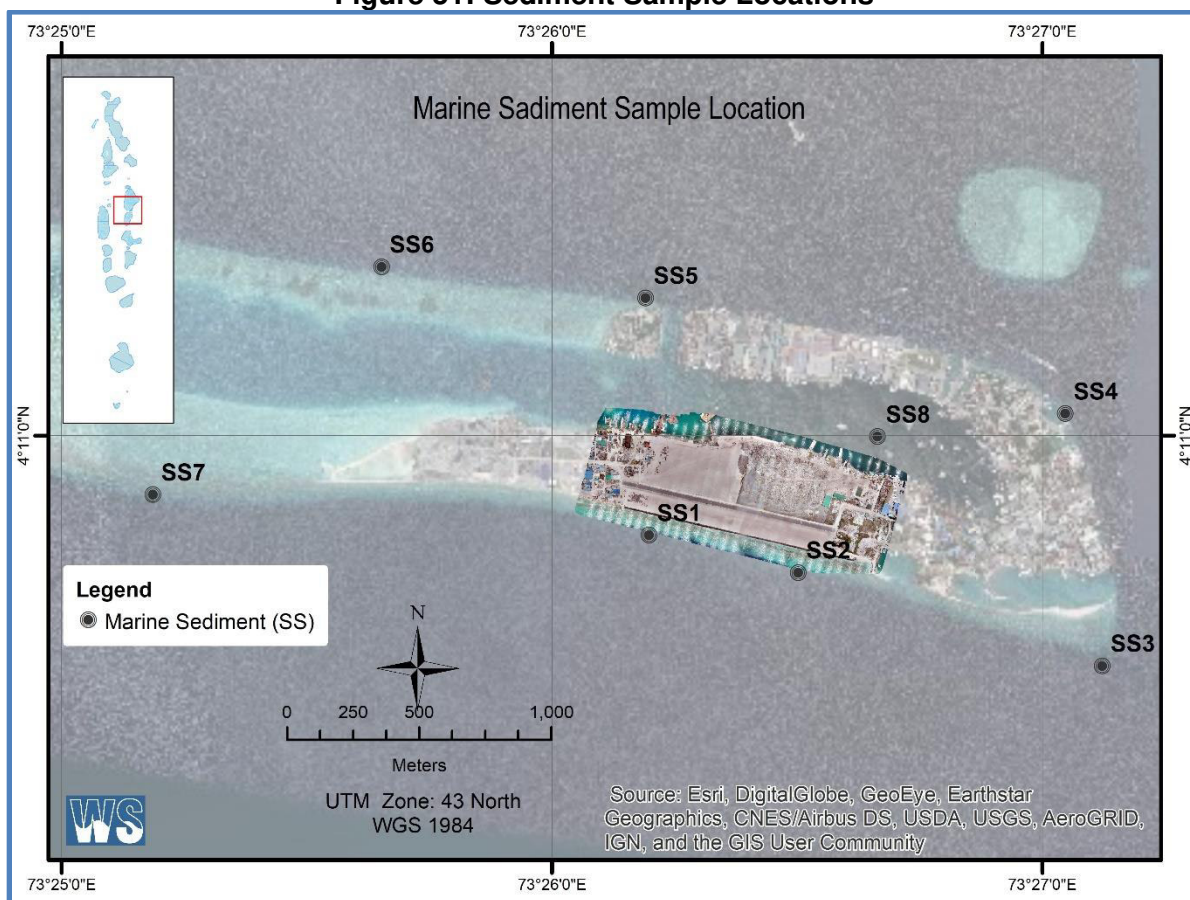
Parameters	Sites Date of Sampling: 03 July 2018							LOQ <sup>29</sup>	Unit	Test Method	Corresponding Maldivian Marine Monitoring Standard	
	SW1	SW2	SW3	SW4	SW5	SW6	SW7				Parameter	Reference
Temperature at receiving (°C)	24.2	24.2	24.2	24.2	24.2	24.2	24.2	-	°C	APHA 20 <sup>th</sup> Edition – 2250B	18 – 32 °C	GBRMPA, 2009 <sup>30</sup>
Biological Oxygen Demand (BOD)	1	1	1	1	< 1 LoQ 1 mg/l	< 1 LoQ 1 mg/l	< 1 LoQ 1 mg/l	< 1 mg/l	mg/l	HACH Method 8043	<2mg/l	
Turbidity	0.3	0.2	0.1	0.2	0.3	0.2	0.2	-	NTU	APHA 2130 B	3 – 5 NTU (max)	
pH at 24°C	8.4	8.4	8.4	8.4	8.4	8.4	8.2	-	-	FD-MTHD-007:2013 Reference to APHA 4500H+	8 – 8.3	
Nitrate (NO <sub>3</sub> <sup>-</sup> )	0.3	0.4	0.4	0.4	0.5	0.3	0.5	-	mg/l	APHA 4500 – NO <sub>3</sub> -E	< 5mg /l	
Oil & Grease	<2.0	<2.0	<2.0	<2.0	<2.0	<2.0	<2.0	2.0	mg/l	FD-MTHD-032:2013 Reference to APHA 5520B	n/a	
Free Ammonia (NH <sub>3</sub> )	0.05	<0.02	<0.02	<0.02	0.05	0.05	<0.02	-	mg/l	SLS 614 Appendix A:2013	2 – 3 mg/l (max)	
Salinity	36	37	37	37	36	37	36	-	ppt	Alpha 2520	32 – 42 ppt	GBRMPA, 2009
<b>Heavy Metals</b>												
Arsenic (As)	ND	ND	ND	ND	ND	ND	ND	0.001	mg/l	CPSD-AN-00581-MTHD with ICP-MS	n/a	
Cadmium (Cd)	ND	ND	ND	ND	ND	ND	ND	0.0001	mg/l		n/a	
Lead (Pb)	ND	ND	ND	ND	ND	ND	ND	0.001	mg/l		n/a	
Mercury (Hg)	ND	ND	ND	ND	ND	ND	ND	0.00005	mg/l		n/a	
Nickel (Ni)	ND	ND	ND	ND	ND	ND	ND	0.001	mg/l		n/a	
Copper (Cu)	ND	ND	ND	ND	ND	ND	ND	0.001	mg/l		n/a	
Zinc (Zn)	ND	0.003	0.004	ND	ND	0.003	0.008	0.001	mg/l		n/a	
Chromium (Cr)	ND	ND	ND	ND	ND	ND	ND	0.001	mg/l		n/a	

<sup>29</sup> Limit of Quantitation: the lowest concentration of the contaminant that can be reliably measured

<sup>30</sup> Great Barrier Reef Marine Park Authority (2009) Outlook Report 2009

304. **Sediments.** The sediment regime around the present waste disposal area is likely to reflect the leaching of pollutants from the dumped wastes at the Thilafushi Island. As unplanned dumping of wastes on this island has the potential to contaminate sediments of the inner lagoon and outer reef flat area, six sampling stations were selected to get a representative status of the extent of contamination of the sediments due to the current waste disposal methods. Results of sediment analysis show heavy metal contents (cadmium, lead, zinc, copper, chromium, nickel, mercury, arsenic) are below the trigger values. See Table 26 for the results.

**Figure 51: Sediment Sample Locations**





**Figure 52: Sediment Grab and Sediment Sample from Inner Lagoon (SS8).**



**Table 26: Sediment chemical properties from sites SS1 to SS8**

Test	Unit	Test method	Results								Limit of Determination	Trigger Value <sup>31</sup>
			Date of Sampling: 23 – 24 April 2018									
			SS1	SS2	SS3	SS4	SS5	SS6	SS7	SS8		
Cadmium (Cd)	mg/kg	Microwave Digestion/ Detection by ICP-Md	ND	ND	ND	ND	ND	ND	0.06	0.07	0.05	1.5
Lead (Pb)	mg/kg		0.06	ND	ND	4.0	0.6	0.3	ND	8.2	0.05	50
Zinc (Zn)	mg/kg		ND	ND	ND	ND	ND	ND	0.3	10.6	0.05	200
Copper (Cu)	mg/kg		ND	0.3	0.1	2.7	0.08	0.6	0.3	15.9	0.05	65
Chromium (Cr)	mg/kg		0.2	0.4	0.4	1.7	0.3	0.4	ND	2	-	80
Nickel (Ni)	mg/kg		ND	ND	ND	ND	ND	ND	ND	ND	0.05	
Mercury (Hg)	mg/kg		ND	ND	ND	ND	ND	ND	ND	ND	0.05	
Arsenic (As)	mg/kg		0.2	0.2	0.2	1.1	0.2	0.2	0.2	1.0	-	20
Polycyclic aromatic hydrocarbons (PAH)	-	-	-	-	-	-	-	-	-	-		

Note: ICP – MS – Inductively Coupled Plasma Mass Spectrometry/ND: Not Detected.

<sup>31</sup> Trigger values, values below which it is unlikely that there will be any biological disturbance for organisms inhabiting the sediment. Values used are those published by the Australian and New Zealand Environment Conservation Council (2000) *Australian and New Zealand Guidelines for Fresh and Marine Water Quality* National Water Quality Management Strategy Paper No. 4

## E. Biological Environment

305. The marine environment of Thilafushi consists of shallow lagoon, deep lagoon, reef-flat, and reef slope areas. Thilafushi Island is situated on the southern rim of North Male 'Atoll near Gulhifalhu. Almost half of Thilafushi lagoon is now reclaimed. The deep lagoon area is used as a mooring basin.

### 1. The Lagoon and Reef System

306. Thilafushi consists of deep, shallow lagoon, reef flat and reef slope areas. More than half of the shallow lagoon or reef flat area is now reclaimed. The south wing of Thilafushi is wider compared to north wing. The widest reef flat area is on the south wing on the west side of the reef. The enclosed deep lagoon area towards east is well protected with very restricted water movement. This area is used by vessels as a mooring basin. The stagnant water coupled with waste dumping in this area has degraded the lagoon environment on the east side. The deep lagoon of this area has very low visibility, the bottom substrate of the deep lagoon consists mainly of sand. Towards the east of deep lagoon, the bottom substrate is mainly mud and garbage debris.

307. A coral reef survey of Thilafushi reef was carried out to establish a baseline of the existing coral reef environment. The baseline assessment assessed the diversity and abundance of coral reef, fish, and significant invertebrates that are commonly associated with the reef environment of Maldives. The method involved determining percentage of various benthic substrate (categories) using standard benthic categories for coral reef benthic substrate sampling as described by Hodgson et.al (2006) in Reef Check Instruction Manual: A Guide to Reef Check Coral Reef Monitoring.

308. **Benthic Survey of April 2018.** All surveys were carried out by underwater SCUBA diving. The marine surveys were carried out by surveyors who had been trained to undertake Reef Check surveys as outlined in the Reef Check Instruction Manual: A Guide to Reef Check Coral Reef Monitoring (2006). Based on the Guide to Reef Check Coral Reef Monitoring (2006) photo quadrat surveys were done in order to measure the benthic composition at 7 sites (M1 – M7) located on the outer reef around Thilafushi island. At each of the survey sites benthic composition and fish abundance was surveyed at depths of 5 meters and 10 meters. The inner lagoon was not surveyed as the area is not of ecological importance.

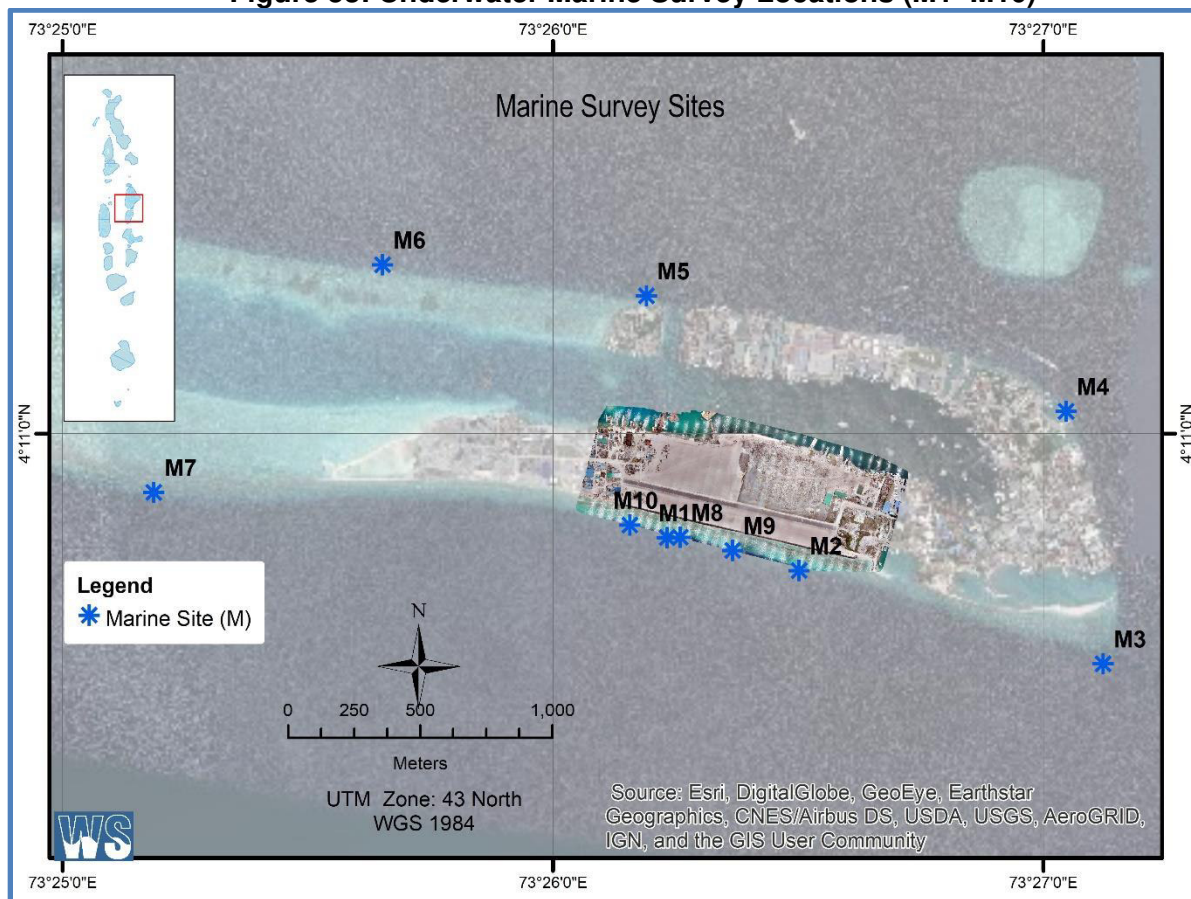
309. The photo quadrat surveys were undertaken. A transect line of 20 meters at each site is set out, the surveyor then places a half a meter quadrat made from PVC along the transect line and takes a photo directly from vertically above. The second photo is then taken along in the same manner after approximately 1 m away from the first photo. In this manner, photos are taken along the transect line and in total, 10 photos on each transect line are taken. In each of the sites 4 transects were placed in two depths (5 & 10m). The surveys were undertaken on 23-24 April 2018.

310. **Reef Profile and Underwater Marine Life Survey of September 2019.** Three additional sites (M8 – M10) were surveyed on 1 September 2019 using photo quadrat methods. This particular underwater survey was conducted to provide more in-depth information at three alternative sections of the southern coastal boundary of the proposed project site where the cooling water discharge line from the WTE plant will be laid. Section V provides the detailed discussions on the result of this additional survey. Unlike the conventional reef transect surveys, the three sections were assessed for benthic composition by undertaking photo quadrats from

the top reef of up to 30 meters, along the reef profile. Before start of the survey, the starting points of the three sections were marked using a plastic bottle tied with a rope and weight at its end. The weight rested at the top reef, approximately 5 meters from the reef slope. This allowed the divers to descent from the exact required location up to 30 meters. Photos were taken using the half meter quadrat made from PVC along the transect line (vertical) and takes a photo directly from above. The second photo is then taken along in the same manner after approximately 1 below the first photo. In this manner, photos are taken along the transect line.

311. Figure 53 below shows the locations of the marine surveys undertaken in April 2018 and September 2019.

**Figure 53: Underwater Marine Survey Locations (M1–M10)**



312. **Data Processing Methodology.** Analysis of the photos was done using a computer program called, CPCe (Coral Point Count with Excel extensions). This is an internationally recognized software used all over the world to assess the benthic composition of the reefs. In this program, photographs are analyzed using pre-defined benthic categories. Depending on the type of survey, these categories can be user defined at any given level. Users can have very complex levels ranging from individual coral families or have broader assessment categories. As the objective of this survey was to assess the impact of dredging and reclamation, it made sense to use a broader category. Hence, benthic categories adopted by the Reef Check protocol were utilized. A text file containing these categories was created and imported to CPCe. The Reef Check protocol allows categorizing life forms followed under the Reef Check protocol, which emphasizes on benthic composition categorizing such as hard corals, sand, rock and others. The

emphasis is not on recording corals to their species levels, but rather the general coral and other life forms such as hard and soft corals. This method is more accurate as the percentage of healthy coral cover and other life forms can be more accurately recorded even by a non-experienced surveyor.

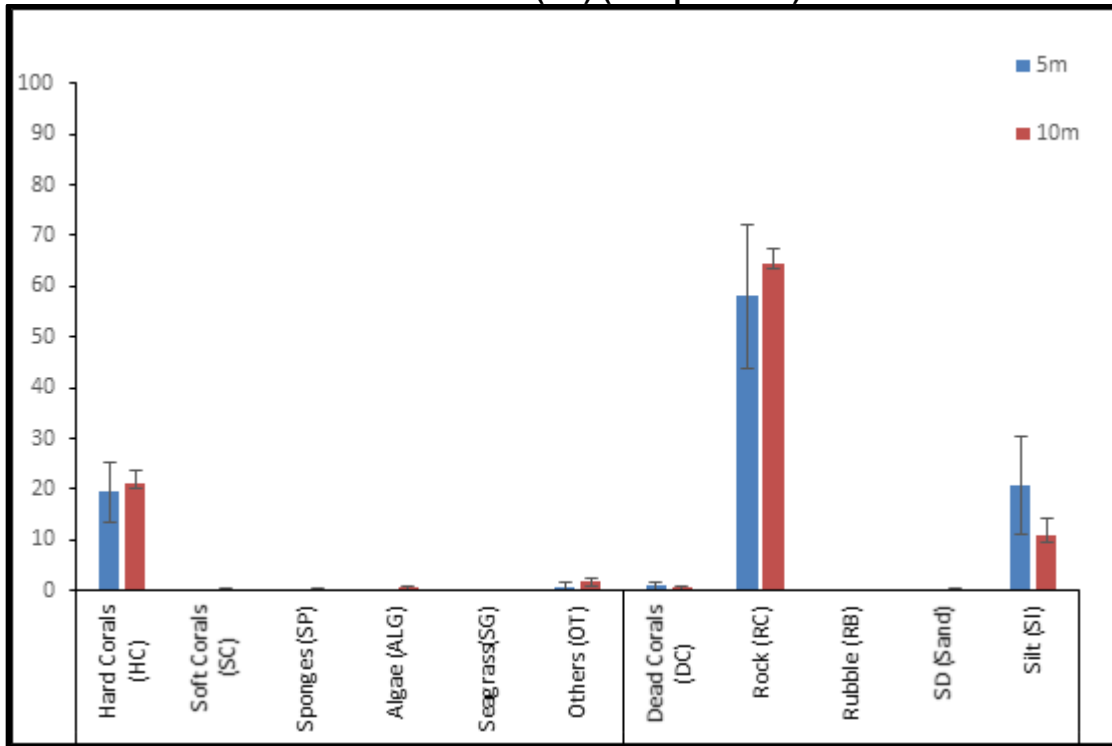
313. The following are definition of benthic categories used in this survey.

- (i) **HC:** All living coral including bleached coral; includes fire, blue and organ pipe corals
- (ii) **SC:** Include zoanths but not anemones (OT)
- (iii) **DC:** Coral that has died within the past year; appears fresh and white or with corallite structures still recognizable
- (iv) **ALG:** All macro-algae except coralline, calcareous and turf (record the substrate beneath for these); Halimeda is recorded as OT; turf is shorter than 3cm.
- (v) **SP:** All erect and encrusting sponges (but no tunicates).
- (vi) **RC:** Any hard substrate; includes dead coral more than 1 year old and may be covered by turf or encrusting coralline algae, barnacles, etc.
- (vii) **RB:** Reef rocks between 0.5 and 15cm in diameter
- (viii) **SD:** Sediment composed of particles of less than 0.5cm in diameter; in water, falls quickly to the bottom when dropped.
- (ix) **SI:** Sediment that remains in suspension if disturbed; recorded if color of the underlying surface is obscured by silt.
- (x) **OT:** Any other sessile organism including sea anemones, tunicates, gorgonians or non-living substrate.
- (xi) **SG:** All types of sea grass observed categorized in the field SG.

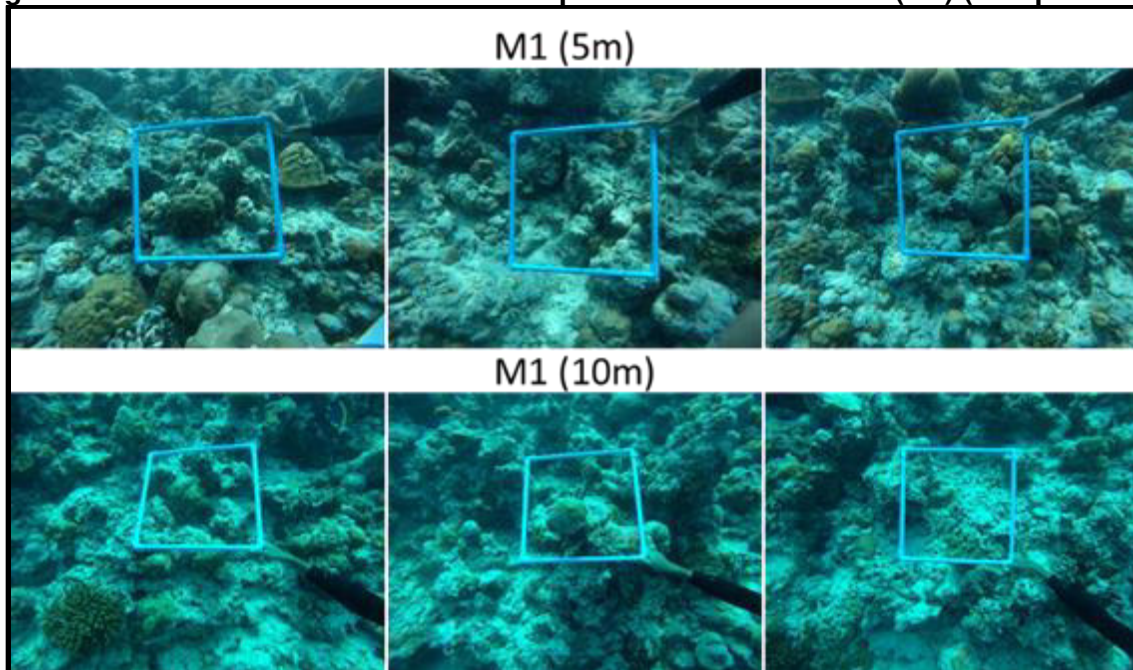
314. Each of the 10 photos from transect are imported, cropped and prepared for analysis. The CPCe program then generates a matrix of random points overlaid on the image for each point to be visually identified. Users can then input the defined categories for each photo and once all the photos are analyzed, the results are displayed on a table.

315. **Status of Site 1 (M1).** Site 1 was selected from the Southern rim of the island reef. The site was chosen as the site was adjacent to the proposed waste rehabilitation center. The substrate at the site is dominated by rock at depths of 5 ( $58 \pm 14.2\%$ ) and 10 ( $64.5 \pm 2.78$ ) meters respectively. Hard coral cover was observed to be moderate at the site at depths of 5 ( $19.5 \pm 5.91$ ) and 10 ( $21 \pm 2.68$ ) meters. Massive porites were the dominating the group of hard coral observed at the site at both the depths. Fishes observed to be abundant at a depth of 5 meters were surgeon fishes, damselfishes and butterflyfishes. Fishes observed to be abundant at a depth of 10 meters were anthias, damselfishes and triggerfishes. The following graph outlines the status of site 1(M1) at depths of 5 and 10 meters.

**Figure 54: Percentage Benthic Composition at site 1(M1) at Depths of 5 and 10 meters  $\pm$  Standard Error (SE) (23 April 2018).**



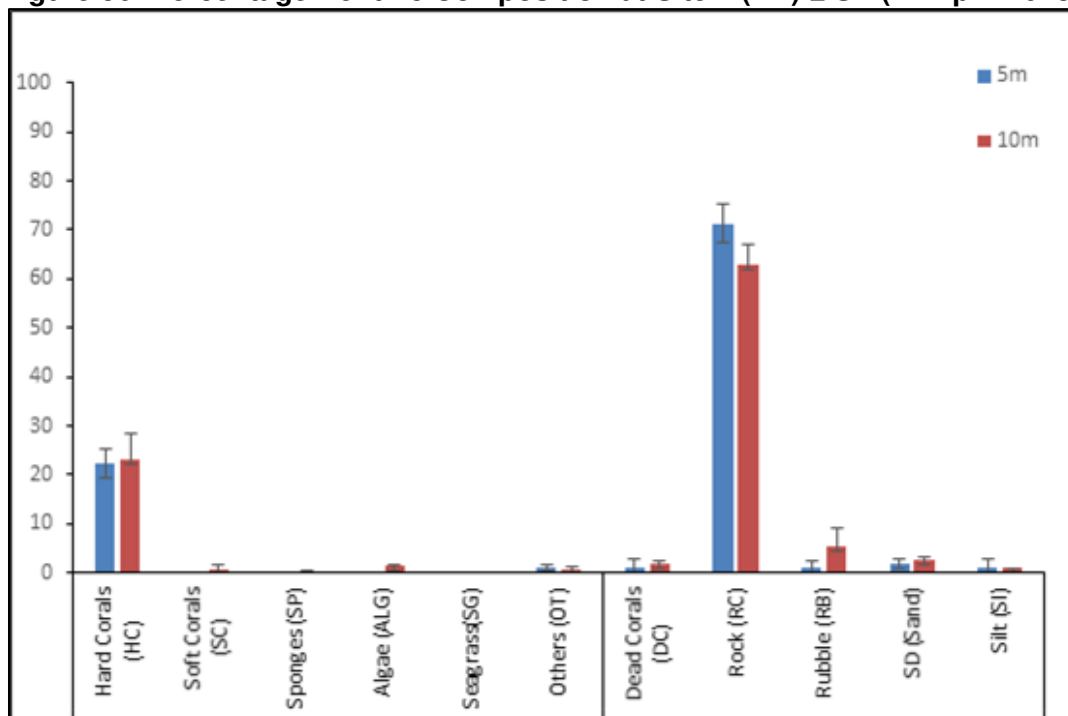
**Figure 55: Photos Taken from Site 1 at Depths of 5 and 10 meters (M1) (23 April 2018).**



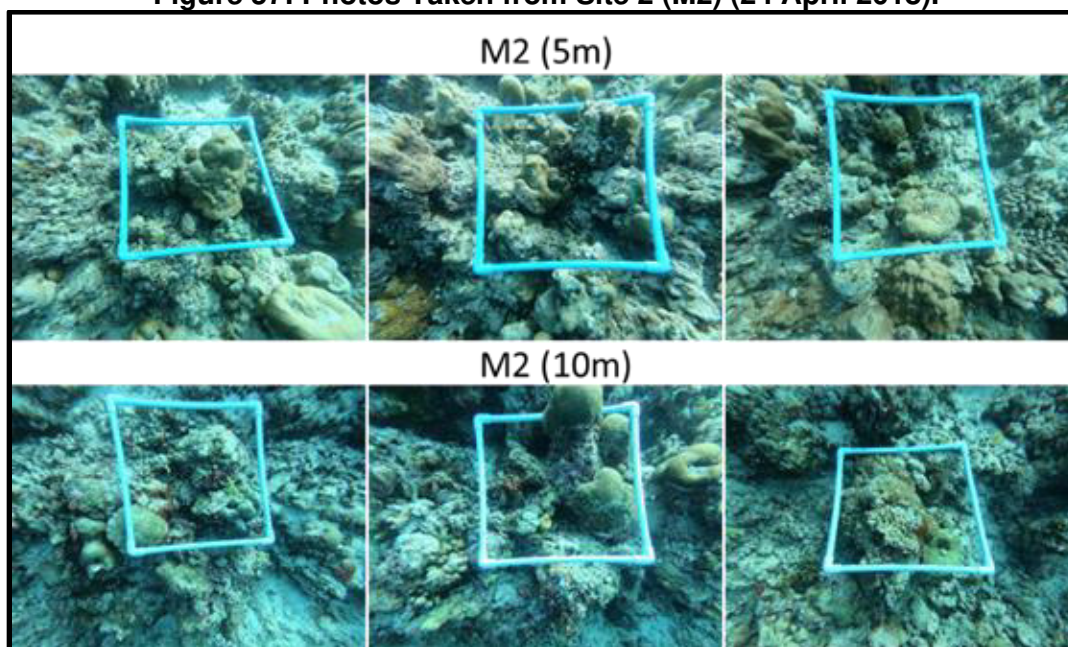
316. **Status of Site 2 (M2).** Site 2 was selected from the Southern rim of the island reef east of site 1. The site was chosen as the site was adjacent to the proposed waste rehabilitation center. The substrate at the site is dominated by rock at depths of 5 ( $71.25 \pm 3.86\%$ ) and 10 ( $63 \pm 6.14$ ) meters respectively. Hard coral cover was observed to be moderate at the site at depths of 5

( $22.25 \pm 2.95$ ) and 10 ( $23.25 \pm 5.17$ ) meters. Massive porites were the dominating group of hard coral observed at the site at both the depths. Fishes observed to be abundant at depth of 5 meters were anthias, surgeon fishes, damselfishes, parrotfishes, triggerfishes and butterflyfishes. Fishes observed to be abundant at depth of 10 meters were anthias, damselfishes, butterflyfishes and triggerfishes. The following graph outlines the status of site 2(M2) at depths of 5 and 10 meters.

**Figure 56: Percentage Benthic Composition at Site 2 (M2)  $\pm$  SE (24 April 2018).**

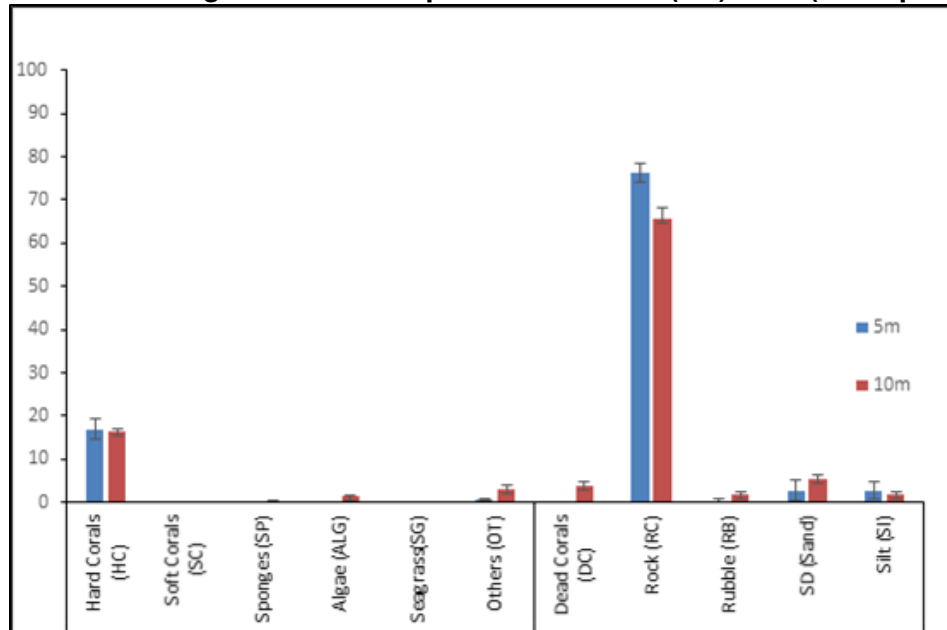


**Figure 57: Photos Taken from Site 2 (M2) (24 April 2018).**

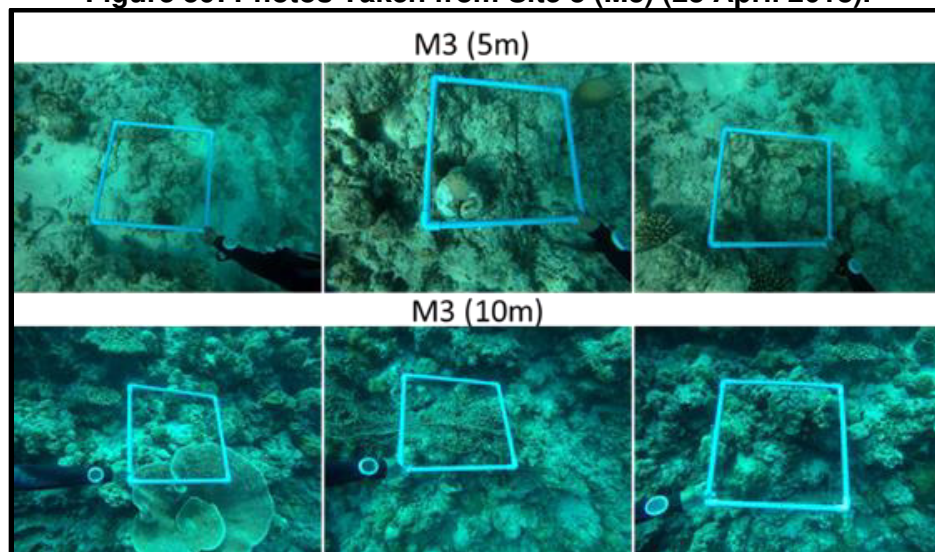


317. **Status of Site 3 (M3).** Site 3 was selected from the Southern eastern corner of the island reef. The site was chosen as a control site as well as to get a broader understanding of the ecological baseline around the reef. The substrate at the site is dominated by rock at depths of 5 ( $76.25 \pm 2.10\%$ ) and 10 ( $65.75 \pm 2.46\%$ ) meters respectively. Hard coral cover was observed to be moderate at the site at depths of 5 ( $17 \pm 2.48$ ) and 10 ( $16.5 \pm 0.65$ ) meters. Massive porites were the dominating group of hard coral observed at the site at both the depths. Fishes observed to be abundant at a depth of 5 meters were surgeon fishes and jacks and trevallies. Fishes observed to be abundant at a depth of 10 meters were anthias, damselfishes and triggerfishes. The following graph outlines the status of site 3(M3) at depths of 5 and 10 meters.

**Figure 58: Percentage Benthic Composition at Site 3 (M3)  $\pm$  SE (23<sup>rd</sup> April 2018).**



**Figure 59: Photos Taken from Site 3 (M3) (23 April 2018).**

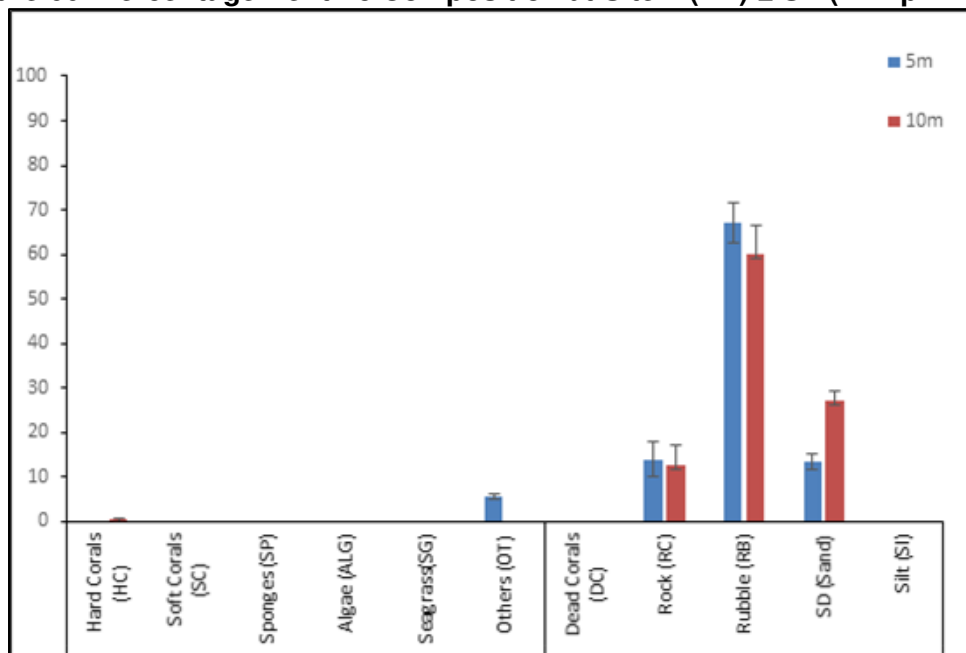


318. **Status of Site 4 (M4).** Site 4 was selected from the North-eastern rim of the island reef. The site was chosen as a control site as well as to get a broader understanding of the ecological

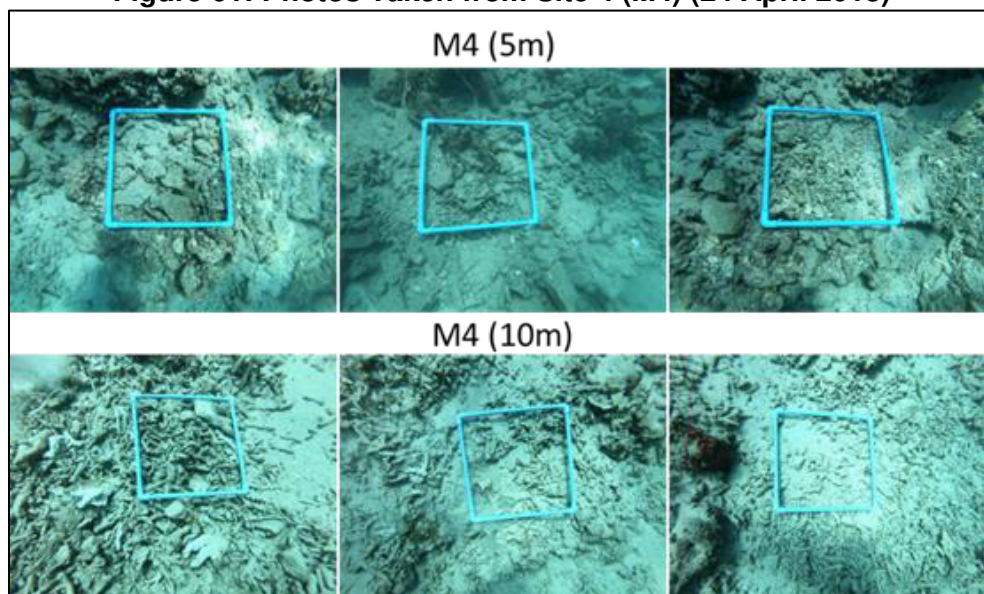


baseline around the reef. The substrate at the site is dominated by rubble at depths of 5 ( $67 \pm 4.49\%$ ) and 10 ( $60 \pm 6.42\%$ ) meters respectively. Hard coral cover was not observed at the site at depths of 5 and 10 meters. Fishes observed to be abundant at a depth of 5 meters were surgeon fishes, butterfly fishes and fusiliers. Fishes observed to be abundant at a depth of 10 meters were only fusiliers. The following graph outlines the status of site 4(M4) at depths of 5 and 10 meters.

**Figure 60: Percentage Benthic Composition at Site 4 (M4)  $\pm$  SE (24 April 2018).**



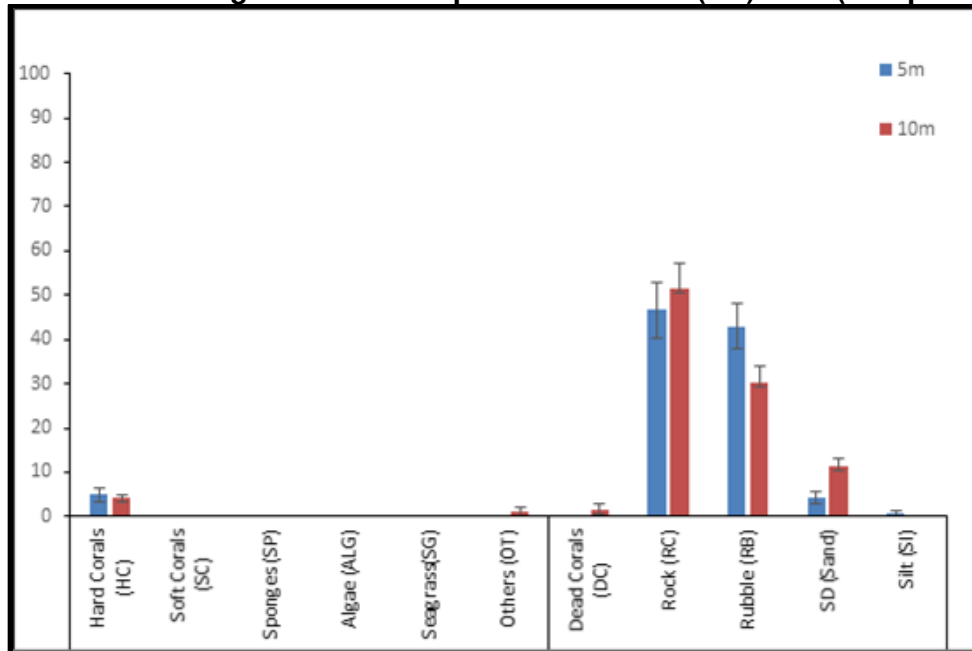
**Figure 61: Photos Taken from Site 4 (M4) (24 April 2018)**



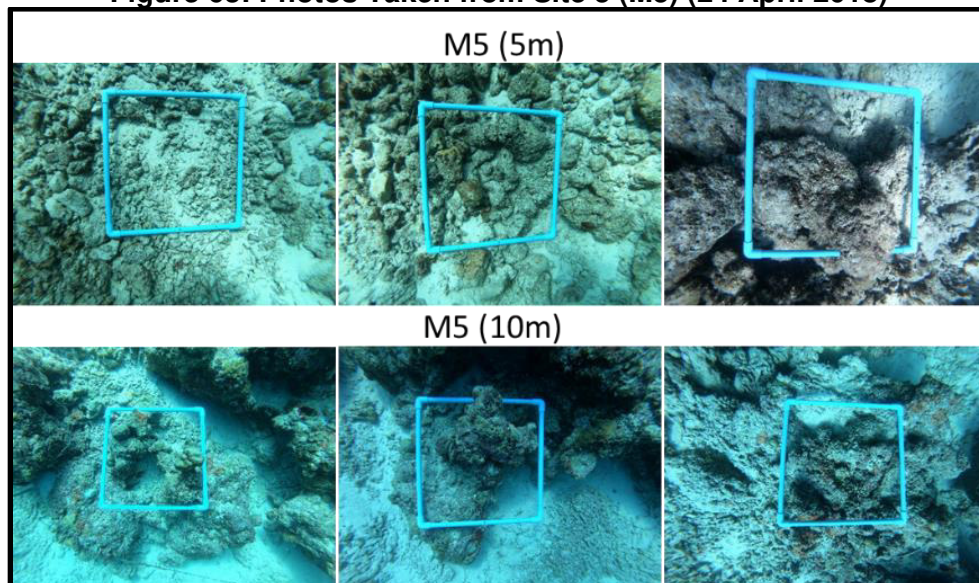
319. **Status of Site 5 (M5).** Site 5 was selected from the Northern rim of the island reef close proximity to the entrance channel. The site was chosen as a control site as well as to get a broader understanding of the ecological baseline around the reef. The substrate at the site is dominated by rock at depths of 5 ( $46.75 \pm 6.28\%$ ) and 10 ( $51.5 \pm 5.81\%$ ) meters respectively. Hard coral cover

was observed to be low at the site at depths of 5 ( $5 \pm 1.58$ ) and 10 ( $4.25 \pm 0.75$ ) meters. Massive porites were the dominating group of hard coral observed at the site at both the depths. Fishes observed to be abundant at a depth of 5 meters were surgeon fishes and parrotfishes. Fishes observed to be abundant at a depth of 10 meters were surgeon fishes, damselfishes and triggerfishes. The following graph outlines the status of site 5(M5) at depths of 5 and 10 meters.

**Figure 62: Percentage Benthic Composition at Site 5 (M5)  $\pm$  SE (24 April 2018)**



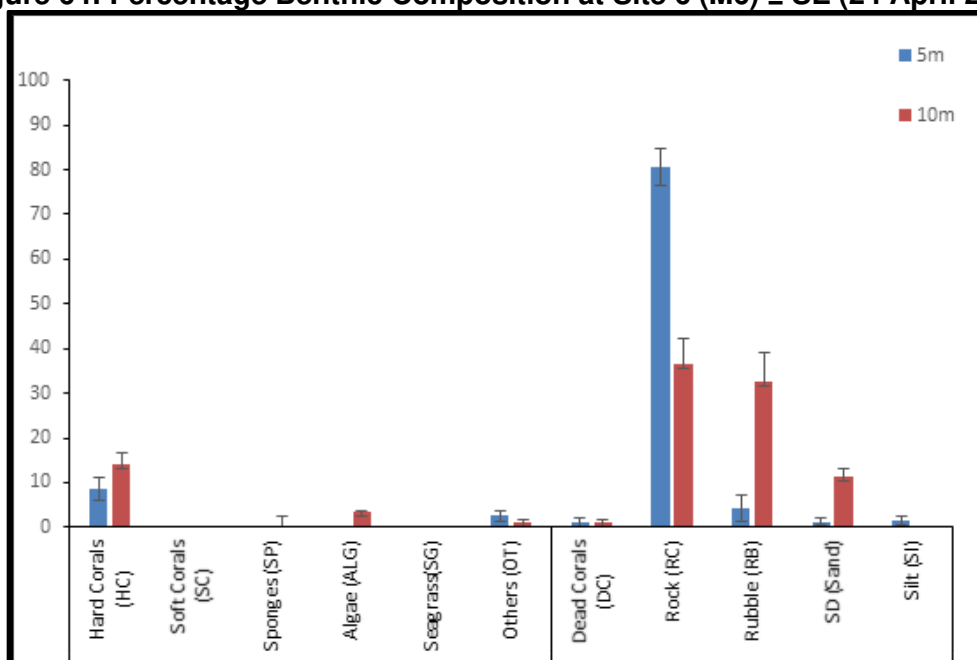
**Figure 63: Photos Taken from Site 5 (M5) (24 April 2018)**



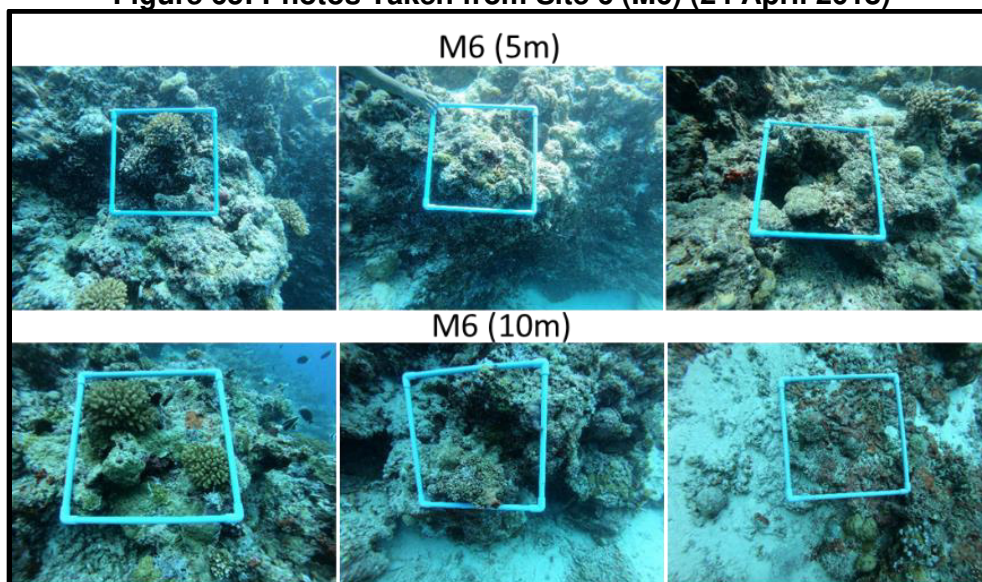
320. **Status of Site 6 (M6).** Site 6 was selected from the Northern rim of the island reef west of site 5. The site was chosen as a control site as well as to get a broader understanding of the ecological baseline around the reef. The substrate at the site is dominated by rock at depths of 5 ( $80.5 \pm 4.19\%$ ) and 10 ( $36.5 \pm 5.85\%$ ) meters respectively. Hard coral cover was observed to be

low at the site at depths of 5 ( $8.75 \pm 2.53$ ) and 10 ( $14 \pm 2.58$ ) meters. Particular group of hard corals were not observed to dominate the substratum. A diverse group of corals from groups such as *Acropora*, *Pocillopora* and *Porites* were observed at the site. Fishes observed to be abundant at a depth of 5 meters were surgeon fishes, wrasses, triggerfishes, damselfishes and butterfly fishes. Fishes observed to be abundant at a depth of 10 meters were surgeon fishes, damselfishes, triggerfishes and butterfly fishes. The following graph outlines the status of site 6(M6) at depths of 5 and 10 meters.

**Figure 64: Percentage Benthic Composition at Site 6 (M6)  $\pm$  SE (24 April 2018)**

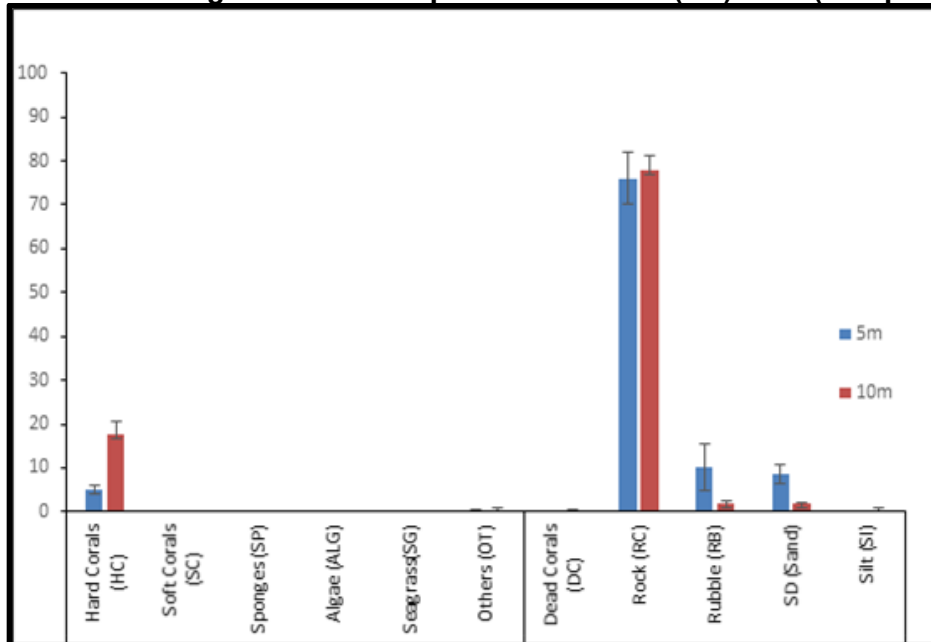


**Figure 65: Photos Taken from Site 6 (M6) (24 April 2018)**

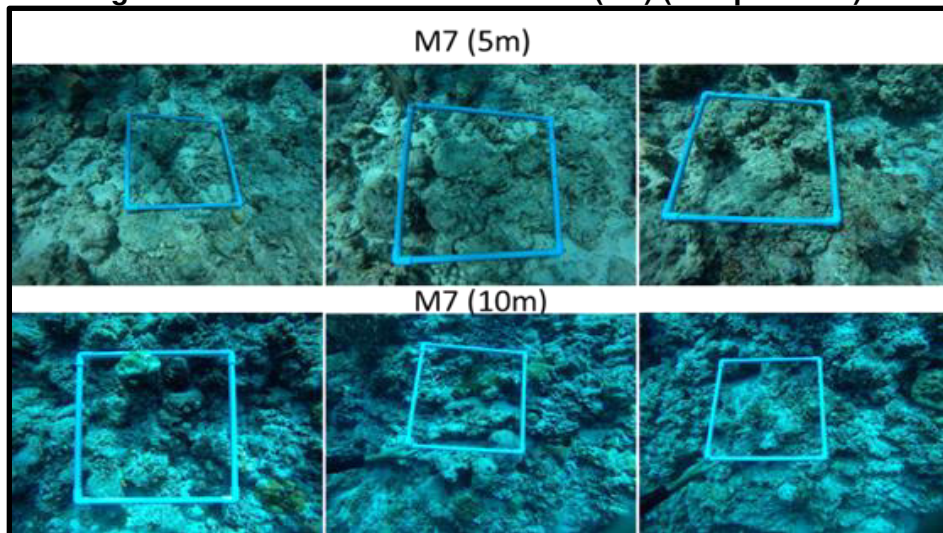


321. **Status of Site 7 (M7).** Site 7 was selected from the Southern rim of the island reef west of site 1. The site was chosen as a control site as well as to get a broader understanding of the ecological baseline around the reef. The substrate at the site is dominated by rock at depths of 5 ( $76 \pm 5.87\%$ ) and 10 ( $77.75 \pm 3.33\%$ ) meters respectively. Hard coral cover was observed to be low at 5 meters ( $5 \pm 1\%$ ) and moderate in 10 meters ( $17.5 \pm 3.2\%$ ). Massive porites were the dominating group of hard coral observed at the site at both the depths. Fishes observed to be abundant at a depth of 5 meters were surgeon fishes, damselfishes and butterfly fishes. Fishes observed to be common at a depth of 10 meters were surgeon fishes. The following graph outlines the status of site 7(M7) at depths of 5 and 10 meters.

**Figure 66: Percentage Benthic Composition at Site 7 (M7)  $\pm$  SE (23 April 2018)**



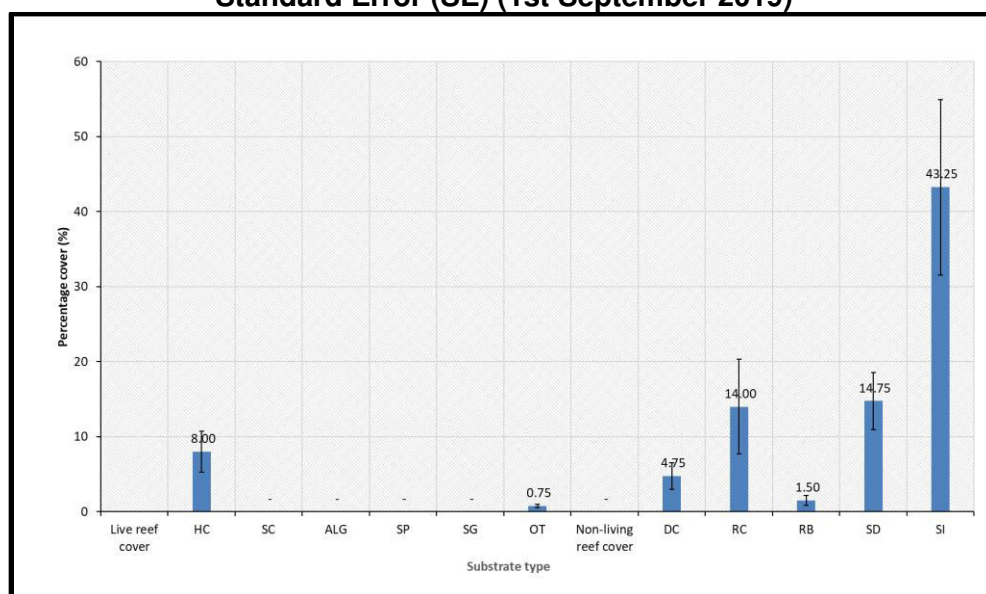
**Figure 67: Photos Taken from Site 7 (M7) (23 April 2018)**



322. **April 2018 Underwater Survey Results.** The highest coral cover was observed at the depth of 10 meters in site M2 adjacent to the current waste dumping area. Therefore, there is the possibility the leachate from landfill is not having any negative impacts on the reef at site M2.

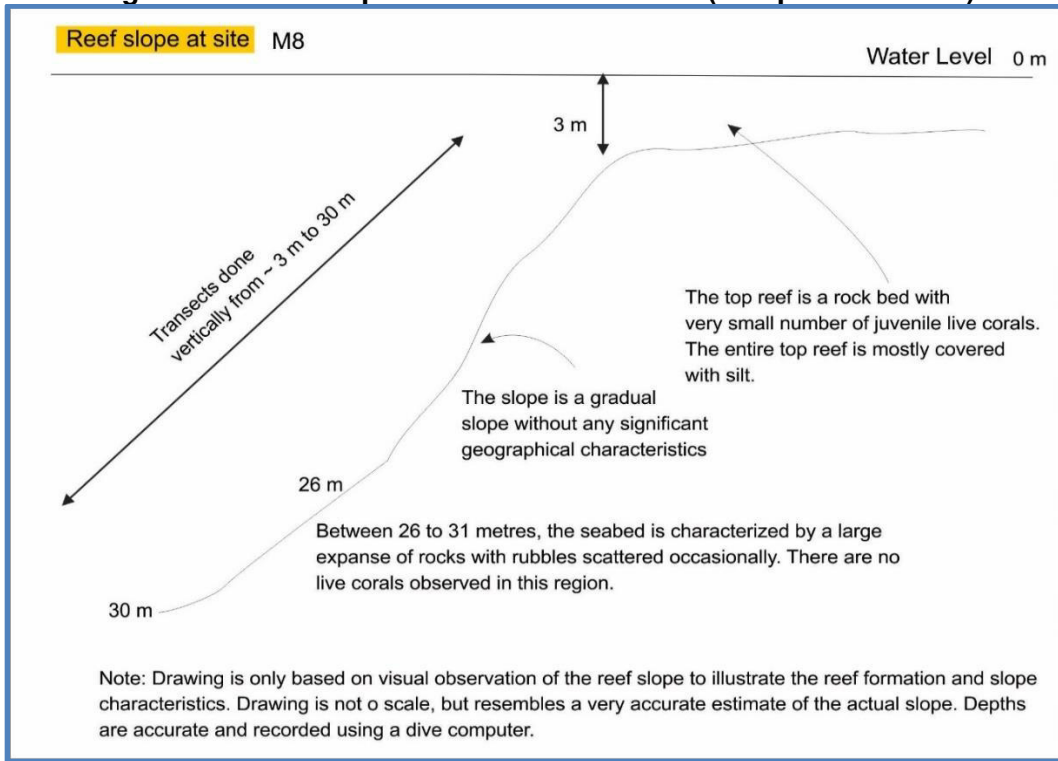
323. **Status of Site M8.** Site M8 was selected from the Southern rim of the island reef. The site was chosen as the best alternative location to lay the hot water discharge line and outfall (see Section IV on Alternative Analysis). The substrate at the site is dominated by silt along the entire transect line ( $43 \pm 11.69\%$ ). Hard coral cover was observed to be low ( $8 \pm 2.71$ ). Massive porites were the dominating the group of hard coral observed at the site. Fishes observed to be very rare. It is to be noted that just a week prior to the survey, due to the severe weather, this entire stretch of reef has been hit by strong waves causing the sediments on the western side of the Thilafushi to be spread along most part of the southern side. This has resulted in large areas of the reef being covered with silt, which were observed at various sampling sites (M9 and M10). Figure 68 below outlines the status of site M8.

**Figure 68: Percentage benthic composition at site M8 at depths from ~ 3 to 30 meters  $\pm$  Standard Error (SE) (1st September 2019)**



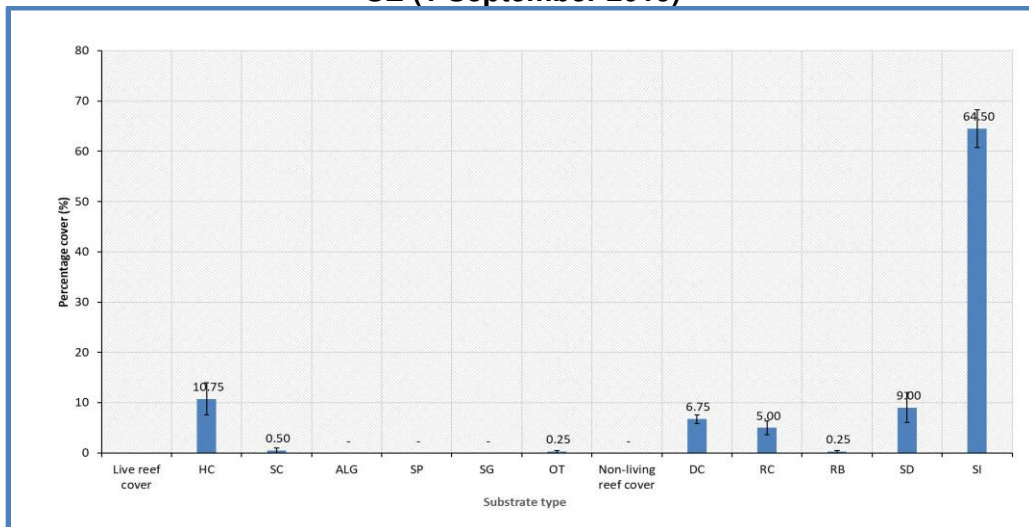
324. The following figure illustrates the reef slope characteristics at site M8.

**Figure 69: Reef Slope Characteristics at M8 (1 September 2019)**



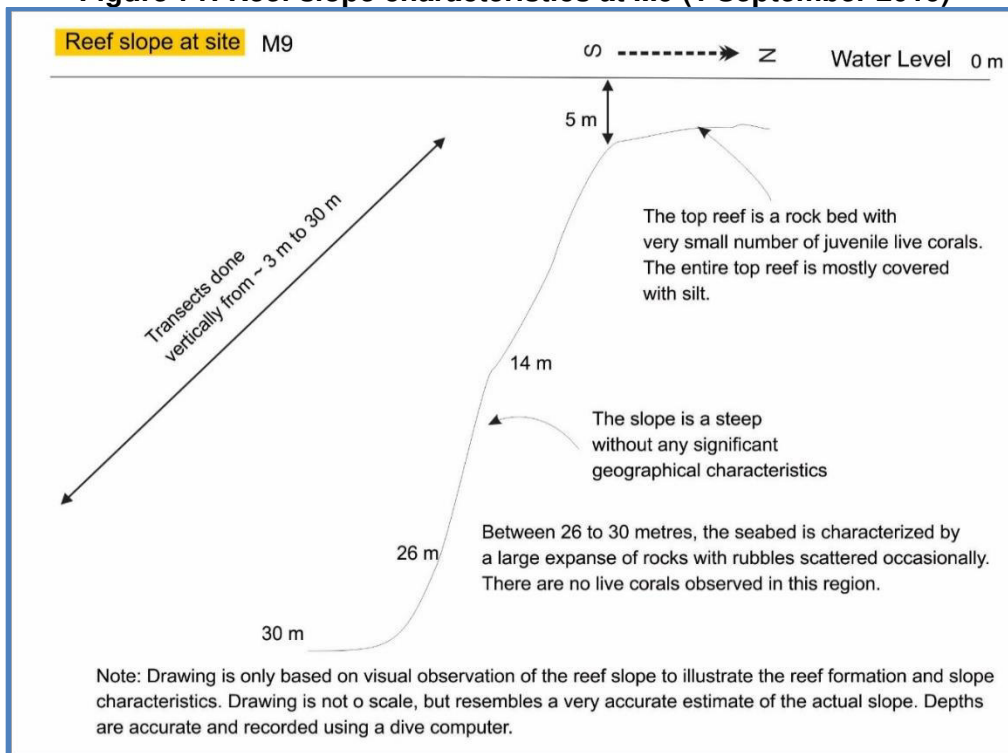
325. **Status of Site M9.** Site M9 was also selected from the Southern rim of the island reef east of site 1. The site was also chosen as an alternative location to lay the hot water discharge line and outfall (see Section IV on Alternative Analysis). The substrate at the site is dominated by silt ( $64.5 \pm 3.77\%$ ). Hard coral cover was observed to be low along the surveyed depths from approximately 3 to 30 meters ( $10.75 \pm 3.22$ ). Massive porites were the dominating group of hard coral observed at the site. Fishes observed were very low and includes anthias and surgeon fishes (refer to the fish census table for details). The following graph outlines the status of site M9.

**Figure 70: Percentage benthic composition at site M9 at depths from ~ 3 to 30 meters  $\pm$  SE (1 September 2019)**



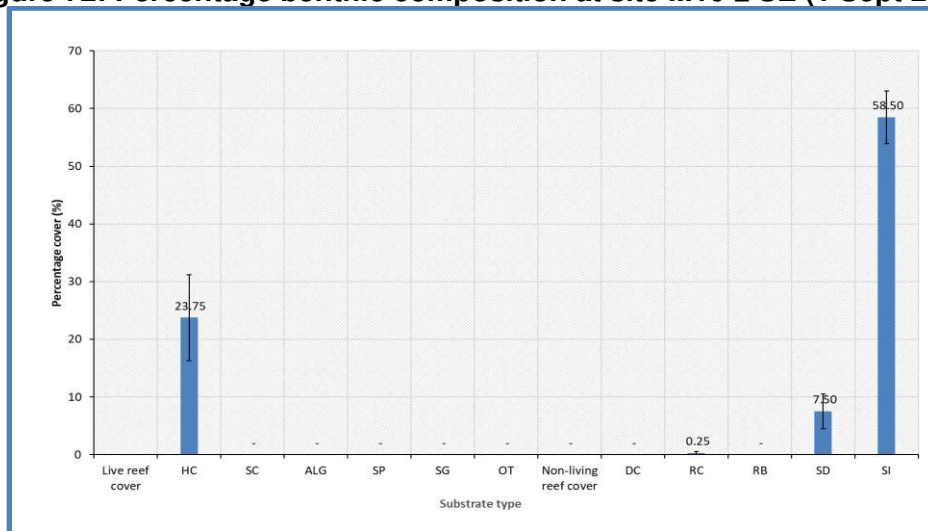
326. The following image illustrates the reef slope characteristics at site M9.

**Figure 71: Reef slope characteristics at M9 (1 September 2019)**

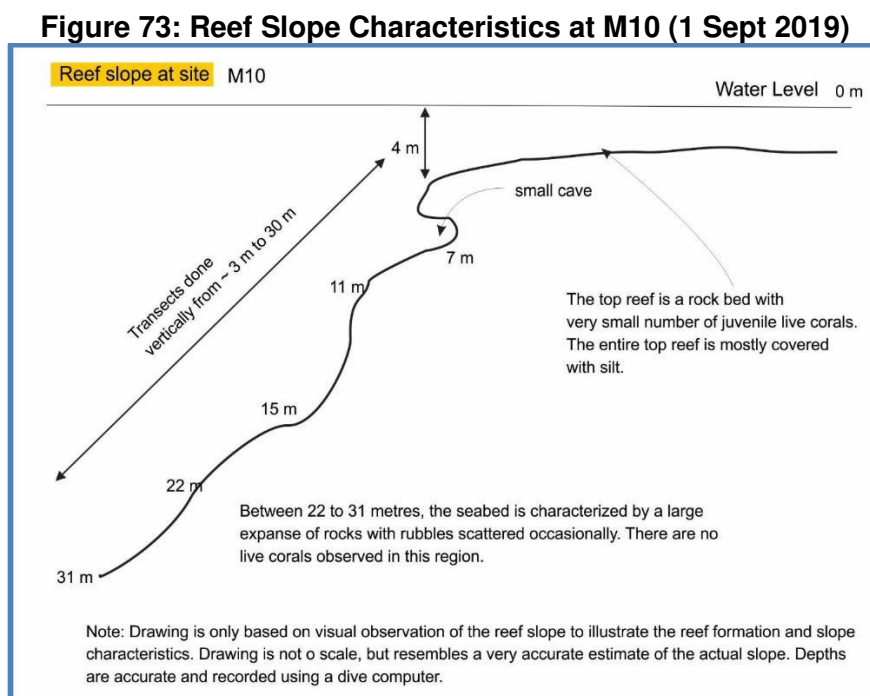


327. **Status of site M10.** Site M10 was also selected from the Southern side of the island reef. The site was also chosen as an alternative location to lay the hot water discharge line and outfall (see Section IV on Alternative Analysis). The substrate at the site is dominated by silt ( $58.50 \pm 4.57\%$ ). Hard coral cover was observed to be moderate ( $23.75 \pm 7.43\%$ ). Massive Porites were the dominating group of hard coral observed at the site. Fishes observed to be very low. The following graph outlines the status of site M10.

**Figure 72: Percentage benthic composition at site M10 ± SE (1 Sept 2019)**



328. The following figure illustrates the reef slope characteristics at site M10.



## 2. Manta Tow Survey

329. The following table outlines the results of the Manta Tow survey around the reef edge.

**Table 27: Manta Tow Survey Results of Approximate Substrate Cover**

	Live Coral cover%	Dead coral cover%	Soft corals cover%	Rock cover %	Rubble cover %	Silt cover %	Benthic diversity	Fish diversity
5 meters								
	5	8	-	15	2	70	low	low
10 meters								
	10	6	-	27	7	50	Low	low

330. The Manta Tow survey showed that coral reef system along the surveyed stretch at M8, M9, and M10 sections is not in very good conditions in term of percentage live coral cover, diversity of corals, benthic and pelagic life. The overall live coral cover of the reef system appeared to be approximately 5% at 5 meters depth and approximately 10% at 10 meters depth. The reef substrate at both these depths were dominated by silt. Abundance and diversity of fish was also lower along the stretch. The live coral cover was highest at 10 meters. The corals in most abundance were massive type coral head belonging to the genus *Porites*.

331. **Protected marine species.** During the Manta tow survey, no protected marine species such as sharks were observed and recorded.

332. **Reef Aesthetics.** This attribute was assessed by visual observations based on the observer's judgment and experience of the relative merits of a reef in the Maldives. This value



judgment incorporated coral cover, diversity of life forms, fish life, reef structure and general appeal. The following categories were used to determine aesthetics of the reef system:

- (i) **Very poor** (mostly dead corals, pelagic life not abundant and diversity very low, structure uniform).
- (ii) **Poor** (Lot of dead corals, pelagic life not abundant and diversity low, some differences in structure).
- (iii) **Average** (Live corals about 10%, pelagic life abundant, diversity low, some structural variations exists).
- (iv) **Good** (Live corals about 20% pelagic life abundant, diverse, structural variations exists).
- (v) **Very good** (Live corals about 30%, pelagic life abundant, diverse, overhangs, and other structures).
- (vi) **Excellent** (Live corals over 40%, pelagic life very abundant, very diverse, lots of different structures, overhangs, caves, gullies, and different habitat types exists).

333. Reef aesthetics of Thilafushi's coral reef system (along the 500 meters) is regarded as very poor, given that substantial level of the reef is covered in silt and poor diversity of life forms. Fish life and abundance are very poor at the time of surveying and generally this stretch of reef can be considered to be "very poor".

i. ***Fishery***

334. The amount and type of fish present at a given site can be a good indicator of the marine environment. For example, increased grazers are generally a sign of increased nutrients in the area, thus decreased coral cover and increased algal cover. 15-minute fish counts were done in sites M1-M7 in depths of 5 and 10m. The counts include mega fauna in addition to fishes. The fishes were identified to family level, however some protected species such as the napoleon wrasse, were identified to species level. However, the abundance of this species is rare at site M3, which is more than 1 km away from the project location. The following table outlines the fish count survey at all the sites.

Table 28: Fish abundances observed at sites 1 to 7 at a depth of 5 and 10 meters

Family/Subfamily	Site M1		Site M2		Site M3		Site M4		Site M5		Site M6		Site M7	
	5m	10 m	5m	10 m	5m	10m	5m	10m	5m	10m	5m	10m	5m	10 m
Anthias (Anthiadae)	R	A	A	A	R	A	C	-	R	C	C	C	R	-
Surgeonfishes (Acanthuridae)	A	C	A	C	A	C	A	C	A	A	A	A	A	C
Wrasses (Labridae)	C	C	-	C	-	-	C	C	C	C	A	-	C	-
Parrotfishes (Scaridae)	C	C	A	C	R	R	C	R	A	-	C	C	C	-
Triggerfishes (Balistidae)	C	A	A	A	-	A	R	-	C	A	A	A	C	-
Boxfishes (Ostraciidae)	-	-	R	-	-	-	-	-	-	-	-	-	-	-
Damselfishes (Pomacentridae)	A	A	A	A	-	A	C	-	R	A	A	A	A	-
Groupers (Serranidae)	R	-	R	R	R	-	R	-	R	R	R	R	R	-
Moorish idol (Zanclidae)	R	R	R	R	R	R	R	R	C	R	R	R	R	R
Butterflyfishes (Chaetodontidae)	A	C	A	A	C	C	A	C	R	C	A	A	A	-
Goatfishes (Mullidae)	-	-	R	R	-	-	C	C	R	-	R	-	R	-
Hawkfishes (Cirrhitidae)	-	-	R	R	R	-	-	-	R	-	R	-	-	-
Threadfin and Whiptail breems (Scolopsis)	-	-	-	R	-	-	-	-	-	-	-	-	-	-
Octopus (Octopodidae)	-	-	R	-	-	-	-	-	-	-	-	-	-	-
Fusiliers (Caesionidae)	-	-	-	-	-	-	A	A	-	-	-	-	-	-
Rabbitfishes (Siganidae)	-	-	-	-	-	-	R	-	-	-	R	-	-	-
Gobies (Gobiidae)	-	-	-	-	R	-	-	R	R	-	-	-	-	-
Pipefishes and seahorses (Syngnathinae)	-	-	-	-	-	-	R	-	R	R	-	-	-	-
Puffers (Tetraodontidae)	-	-	-	-	R	-	R	-	C	-	R	-	-	-
Emperors or scavengers (Lethrinidae)	-	-	-	-	-	-	-	-	C	-	R	-	-	-
Jacks and Trevallies (Carangidae)	-	-	-	-	A	-	-	-	R	-	-	-	-	-

Family/Subfamily	Site M1		Site M2		Site M3		Site M4		Site M5		Site M6		Site M7	
	5m	10m	5m	10m	5m	10m	5m	10m	5m	10m	5m	10m	5m	10m
Angelfishes (Pomacanthidae)	-	-	-	-	-	-	-	-	R	-	R	R	-	-
Lizardfishes (Synodontidae)	-	-	-	-	-	-	-	-	R	-	-	-	-	-
Squirrelfishes, soldierfishes (Holocentridae)	-	-	-	-	-	-	-	-	-	-	R	-	-	-
Grunts and Sweetlips (Haemulidae)	-	-	-	-	-	-	-	-	-	R	R	-	-	-
Eels and Morays (Anguilliformes)	-	-	-	-	-	R	-	-	-	-	-	-	-	-
Napoleon Wrasse (Cheilinus undulatus)	-	-	-	-	-	R	-	-	-	-	-	-	-	-
Sharks & Rays (Elasmobranchii)	-	-	-	-	-	R	-	-	-	-	-	-	-	-
Sea Turtles (Cheloniodea)	-	-	-	-	-	R	-	-	-	-	-	-	-	-

A= Abundant (Meaning that during the 15-minute time swim survey, species counts were recorded more than 50, hence it is difficult to count their numbers).  
C=Common (Meaning that during the 15-minute time swim survey, they were spotted occasionally and throughout the survey, but their numbers were less than 50).  
R=Rare (Meaning that during the survey, only few of these species were observed, often 1 or 2).

ii. ***Aquatic Biology***

335. Plankton are the base of the marine food chain. The phytoplankton and zooplankton abundances in the area could possibly be affected by the presence of heavy metals. If the plankton community is thriving in these areas the heavy metals maybe bio accumulating in the food chain. Therefore, plankton counts were done around Thilafushi Island in order to establish a baseline. A plankton net of 50µm mesh was built to carry out the survey. The plankton tows were carried out at sites where the marine water samples were collected.

336. **Data Collection Methodology.** A plankton net of opening 0.48 x 0.48 m was tied to a 20m rope and released from a vessel. The net was allowed to drift for 20 meters and then towed towards the boat. Any organisms or particles larger than 50µm gets caught up in the net and collected in the cod end.

337. **Zooplankton.** Analyses of the samples were done using a microscope using a Sedgewick rafter counting chamber. The chamber has a volume of approximately 1ml. The samples collected from the net were approximately 150 – 250ml in volume. For the zooplankton count, the samples were transferred to a beaker diluted to approximately 500 – 900 ml and the volume recorded. The purpose of dilution is to reduce the number of plankton in the optical view of the microscope for ease of counting. Two sub-samples were counted from each sample. To calculate Total count in the sample, the counts in the subsamples were averaged. Thereafter the average value in the sub samples were multiplied with the total Volume in the diluted sample to obtain the Total count in the Sample. From the Total count in the sample and from the opening area of the net and the distance towed, the abundance of zooplankton per meter cube was calculated using the formula,  $Abundance = \frac{\text{Total Count in the Sample}}{(\text{Distance towed} \times \text{Opening area})}$ . During the survey the zoo plankton were classified into Rotifera, Protozoa, Chordata, Mollusca, Annelida, Cnidaria, Crustacea and Chaetognatha. Additionally, Copepods were classified into three groups, Calanoida, Cyclopoida and Harpacticoida.

338. **Phytoplankton.** Analyses of the samples were done using a microscope using a Sedgewick rafter counting chamber. The chamber has a volume of approximately 1ml. The samples collected from the net were approximately 150 – 250ml in volume. For the phytoplankton count, the samples were transferred filtered through a 200µm sieve to remove large zooplankton for ease of counting. Thereafter the sample was transferred to a beaker and diluted to approximately 500 – 900 ml and the volume recorded. The purpose of dilution is to reduce the number of plankton in the optical view of the microscope for ease of counting. Two sub-samples were counted from each sample. To calculate Total count in the sample the counts in the subsamples were averaged. Thereafter the average value in the sub samples was multiplied with the total Volume in the diluted sample to obtain the Total count in the Sample. From the Total count in the sample and from the opening area of the net and the distance towed, abundance of zooplankton per meter cube was calculated using the formula,  $Abundance = \frac{\text{Total Count in the Sample}}{(\text{Distance towed} \times \text{Opening area})}$ .

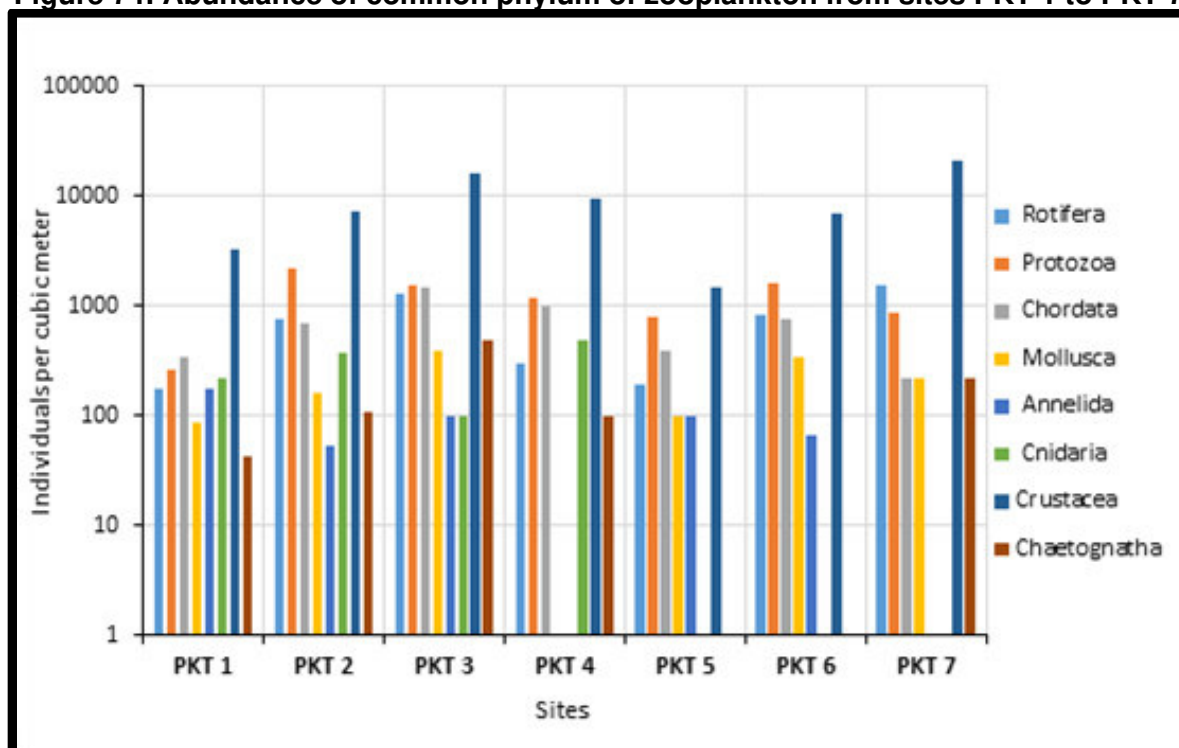
339. **Limitations of the methodology.** The above method gives approximate estimates of abundances for each group/genera of plankton. Using a Sedgewick rafter to count zooplankton limits the subsample volume to 1ml thus, rare groups in plankton would likely not be observed in the counts. The method is reliable to estimate the total abundance of common groups of Zooplankton which are greater than 50µm in size and phytoplankton greater than 50 µm and less than 200µm.

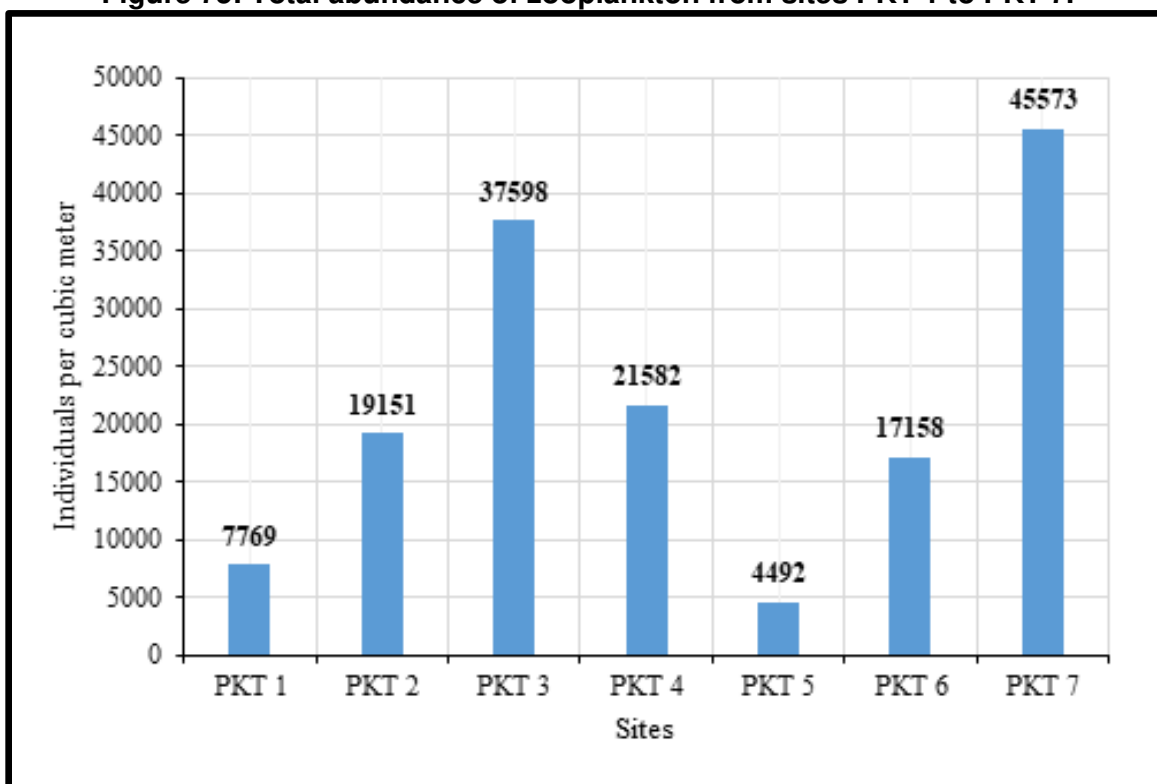
340. **Zooplankton Abundance - Common Phyla.** Crustaceans were observed to be of the highest abundance amongst the zooplankton from all 7 sites. Additionally, the highest abundance of zoo plankton was observed from site 7 (PKT 7). The lowest abundance of zooplankton was observed from site 5. The table and figures below outline the variation in zooplankton abundance between the sites.

**Table 29: Abundance of common phyla of zooplankton from sites PKT 1 to PKT 7**

Phyla	Abundance at sites (Individuals/m <sup>3</sup> )						
	PKT 1	PKT 2	PKT 3	PKT 4	PKT 5	PKT 6	PKT 7
Rotifera	174	760	1,270	293	195	814	1,519
Protozoa	260	2,170	1,563	1,172	781	1,628	868
Chordata	347	705	1465	977	391	746	217
Mollusca	87	163	391	NA	98	339	217
Annelida	174	54	98	NA	98	68	NA
Cnidaria	217	380	98	488	NA	NA	NA
Crustacea	3,212	7,378	16,113	9,277	1,465	6,782	21,267
Chaetognatha	43	109	488	98	NA	NA	217
Total Zooplankton	7,769	19,151	37,598	21,582	4,492	17,158	45,573

**Figure 74: Abundance of common phylum of zooplankton from sites PKT 1 to PKT 7.**

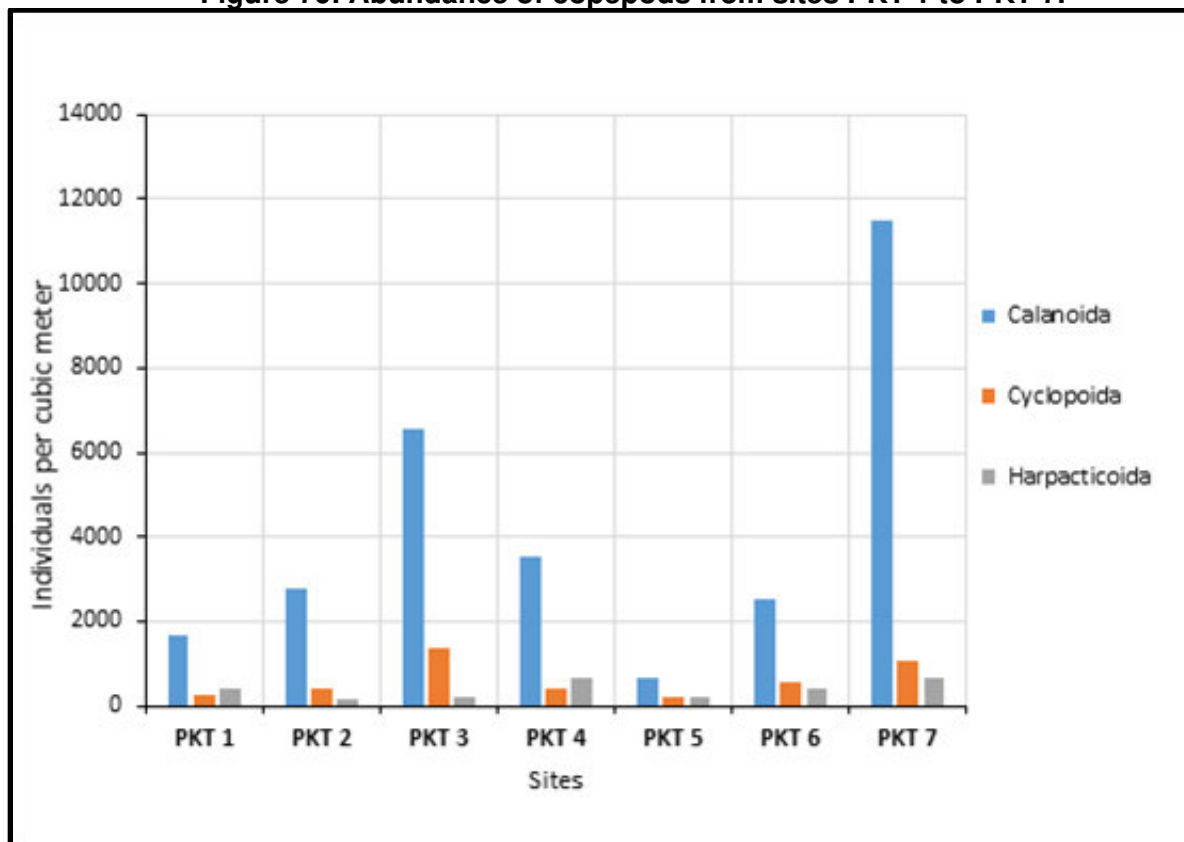


**Figure 75: Total abundance of zooplankton from sites PKT 1 to PKT 7.**

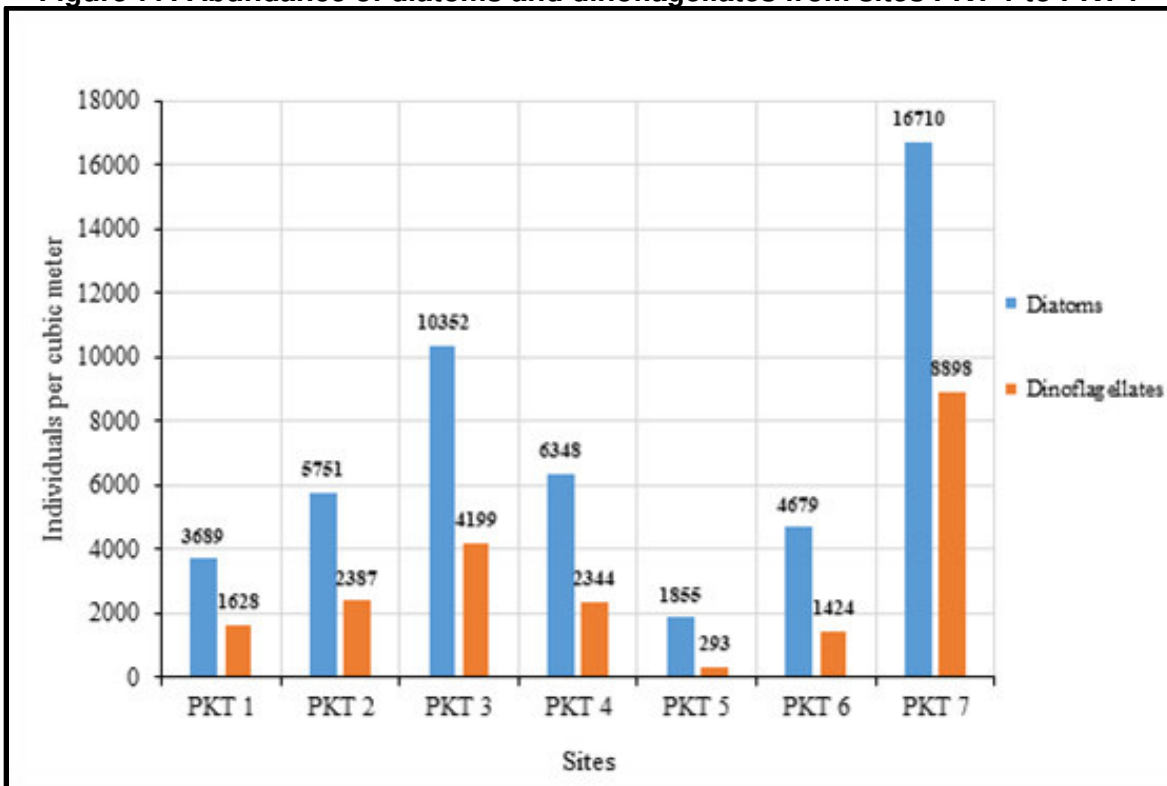
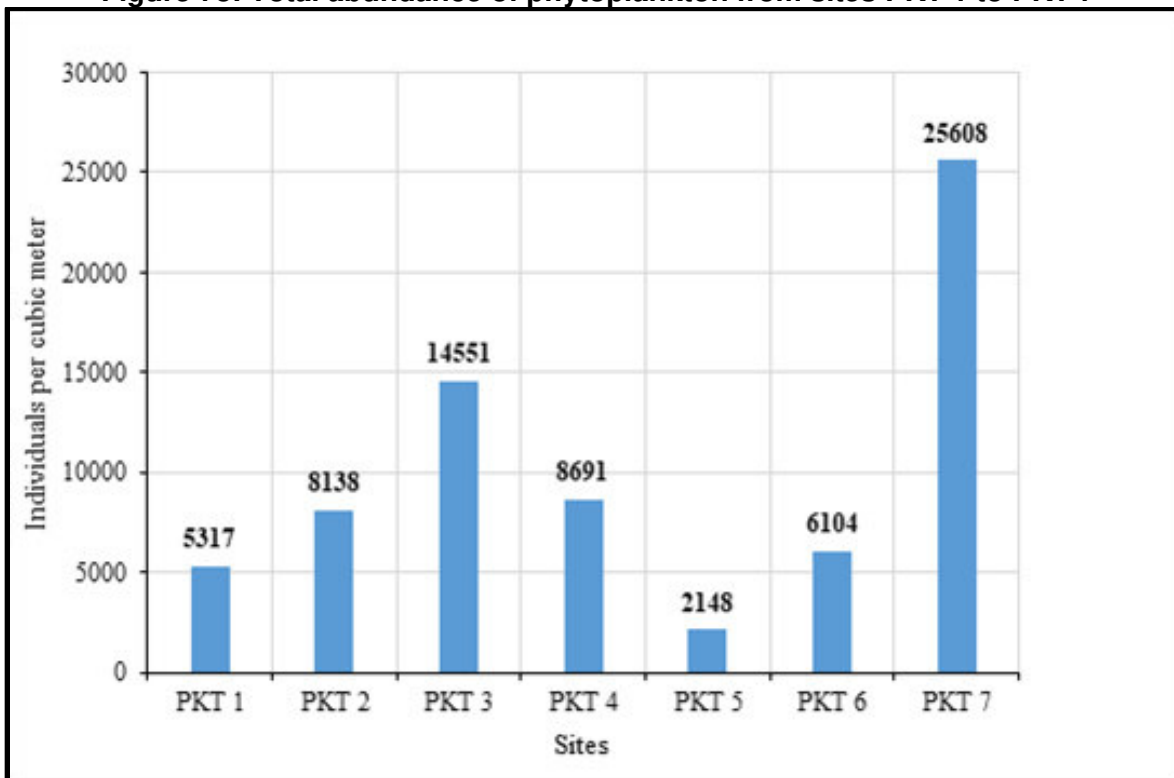
341. **Zooplankton Abundance - Copepods.** The dominating group of copepods observed in the sites were calanoids. The highest abundance of copepods was observed at site 7 and the lowest abundance of copepods at site 5. The table and figure below outline the variation in copepod abundance between the sites.

**Table 30: Abundance of copepods from sites PKT 1 to PKT 7**

Order	Abundance at Sites (Individuals/m <sup>3</sup> )						
	PKT 1	PKT 2	PKT 3	PKT 4	PKT 5	PKT 6	PKT 7
Calanoida	1693	2767	6543	3516	684	2509	11502
Cyclopoida	260	434	1367	391	195	543	1085
Harpacticoida	391	163	195	684	195	407	651

**Figure 76: Abundance of copepods from sites PKT 1 to PKT 7.**

340. Phytoplankton Abundance. Diatoms were observed to be of the highest abundance, amongst the phytoplankton from all 7 sites. Additionally, the highest abundance of phytoplankton was observed from site 7 (PKT 7). Additionally, the lowest abundance of phytoplankton was observed from site 5. The Figures below show the variation in phytoplankton abundance between the sites.

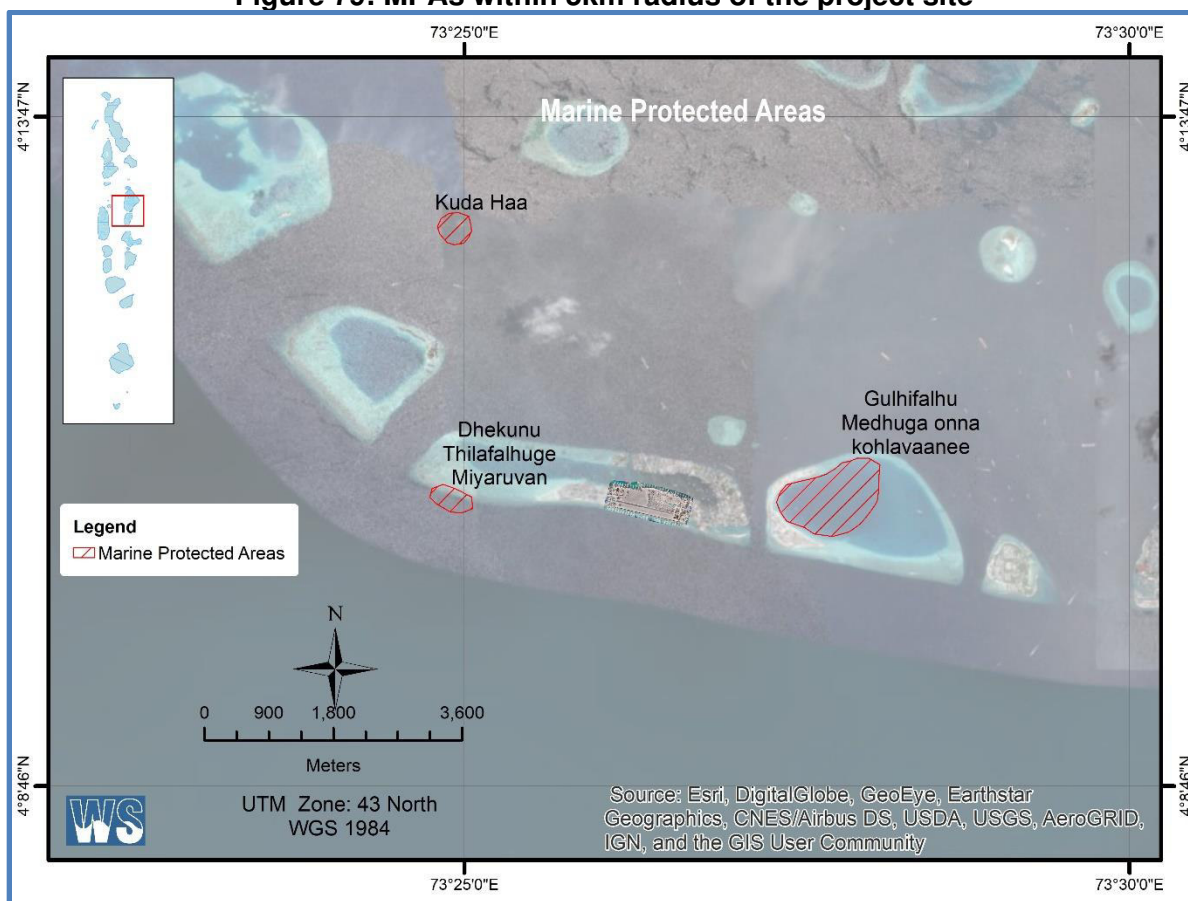
**Figure 77: Abundance of diatoms and dinoflagellates from sites PKT 1 to PKT 7****Figure 78: Total abundance of phytoplankton from sites PKT 1 to PKT 7**



## F. Protected Areas and Critical Habitats

342. **Marine Protected Areas.** According to Maldives EPA, there are 3 Marine Protected Areas (MPAs) within 5km radius from the project site. They are; (i) Dhekunu Thilafalhuge Miyaruvani – this area is also referred to as Lions Head and is on the outside of the South Malé Atoll facing south into Vaadhoo Channel. (ii) Gulhifalhu Medhuga Onna Kollavaanee – this area is referred to as Hans Hass Place, which is the deep lagoon area at Gulhifalhu and (iii) Kuda Haa – isolated reef standing up from a sandy bottom at 30m, north to Giraavaru Island. In addition to the marine protected areas there are other areas that are also designated as ecologically sensitive areas in Kaafu atoll. However, none is located within 5 km radius of the project site.

**Figure 79: MPAs within 5km radius of the project site**



343. Dhekunu Thilafalhuge Miyaruvani (also known as “Lions Head”) is the closest MPA to the project area. The edge of Lions Head is about 1 km from the project site’s boundaries. Lions Head is on the outside of North Malé Atoll facing south into Vaadhoo Channel. From the reef edge at about 8m there is a step down to a steep rubble slope where one can sit to watch the sharks. To the right (west) as one faces out is a large overhang that leads down to over 30 m depth. To the left (east) there is a line of small overhangs in 10-15m that continues for about 150 m. The Maldives EPA consider the Lions Head as a protected seascape (IUCN Category V) which covers ocean with a natural conservation plan which accommodates a range of for-profit activities. It has been a marine protected site since 01 October 1995. As Thillafushi and its surrounding area have undergone a transformational development in the past two decades, Maldives EPA is considering

declassifying Lions Head from being a marine protected area to a more appropriate status reflecting current land use (industrial zone).

344. Gulhifalhu Medhuga Onna Kollavaanee (also known as “Hans Hass Place”) is on the outer reef of North Malé Atoll facing south into Vaadhoo Channel. It is an area about 100m long set back in a large recess in the reef. The reef top is at about 3m and drops vertically to a line of overhangs at 8-10m. The western end is marked by a large cavern at 10-15m. There are further overhangs at 20-25m. Hans Hass Place is named in honor of the great pioneer of diving in Maldives.

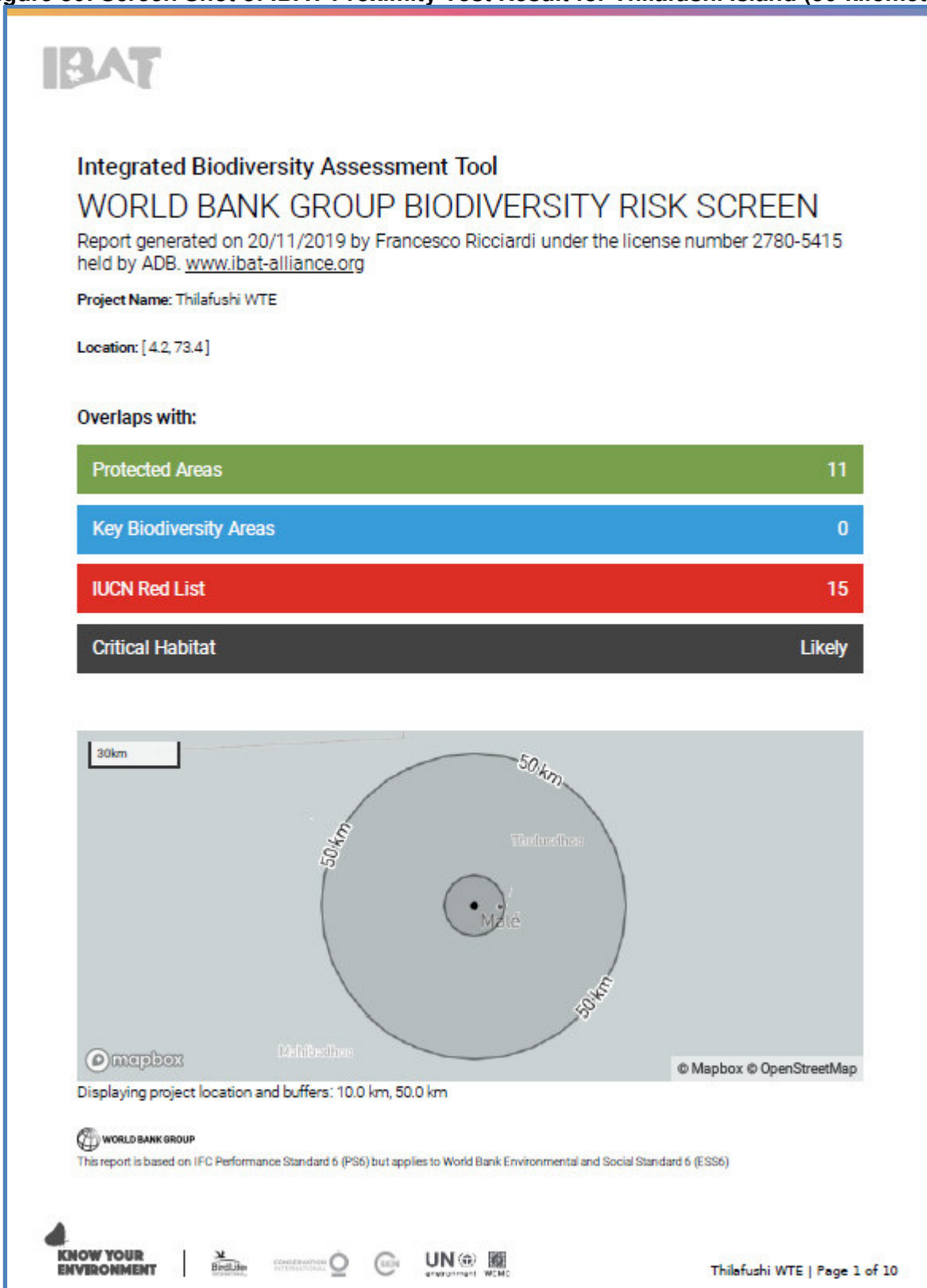
345. Kuda Haa is located about 4km north from the project site. It assumed that no direct impact will be caused to this MPA due to the distance and location.

346. Within the MPAs, anchoring (except in an emergency), coral and sand mining, dumping of waste, removal of any natural object or living creatures, fishing of any kind with exception of traditional live bait fishing and any other activity which may cause damage to the area or its associated marine life are prohibited under the Environment Act.

347. **Critical Habitats.** The Integrated Biodiversity Assessment Tool (IBAT) was initially used to screen and assess potential risks on the protected areas or critical habitat that may exist around the project site (default area of analysis of 50 km radius). Initial screening results show there are no key biodiversity area around the project site but likely to be critical habitat due to the identified MPAs and IUCN Red List species. Hence, a critical habitat assessment was undertaken. Results of the assessment show that the area of analysis, which encompasses the project site, is likely to be a critical habitat at least for a terrestrial insect (*Enallagma maldivense*). This insect normally thrives in freshwater habitats such as ponds. As the project is located in Thilafushi, an island with no freshwater body, it is highly unlikely that this insect is present within and around the island. More so that this insect is not found in the coastal areas and open seas surrounding Thilafushi island. The complete critical habitat assessment report is in Appendix 12. As precautionary measure, the EIA provides measures to ensure no critical habitats, or features for which they are qualified as critical habitats, will be impacted.

348. Figure 80 below shows the screen shots of the IBAT Proximity Test Results.

Figure 80: Screen Shot of IBAT Proximity Test Result for Thilafushi Island (50-kilometer)



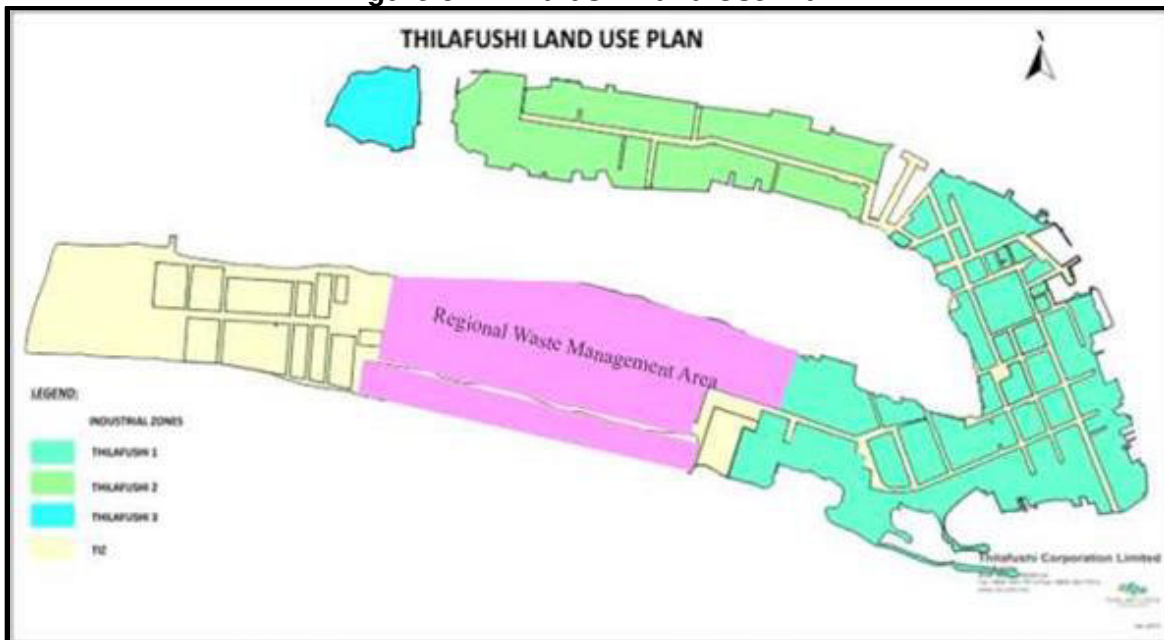
## G. Socio-Economic Conditions

### 1. Physical Infrastructures

349. **Land Use.** Thilafushi is an island that has been reclaimed by dumping of wastes on the submerged “Thilafalhu” lagoon area since December 1992. The island was initially developed as a sand bank using dredged material from the Thilafushi Reef. Since then, land has been reclaimed by placing solid waste in dredged holes on the reef flat and later topping it up with fresh lagoon sand.

350. The land use system of Thilafushi was developed in an ad hoc manner without a master plan. Hence, the present land use patterns show a mixed approach to development with a variety of industrial, manufacturing and warehousing activities being undertaken on the island.

**Figure 81: Thilafushi Land Use Plan**



Source: Thilafushi Corporation Limited.

351. The bulk of the land in Thilafushi is used for manufacturing or industrial activities. These include activities like aluminum product assembly, construction prefabrication, boat building and workshops, among others. Most of these developments are located at Thilafushi 2 (see the legend in Figure 81). This is primarily due to the large plots of land leased from these areas. A number of new manufacturing activities have appeared on the old Thilafushi 1 Island, primarily in the form of workshops, construction related manufacturing and boat building. Some of these plots were initially allocated for warehousing.

352. **Industries.** With the development of Thilafushi as an industrial zone, numerous small and middle industries have been established on the island. The current (major) industrial activities in the island are boat manufacturing, cement packing, methane gas bottling and various large-scale warehousing. In March 2015, the Maldivian government decided to relocate the central commercial port from Malé to Thilafushi. This project is still pending.

353. **Commercial and Industrial Activities.** The major activities in Thilafushi are industrial activities, importing and stockpiling of construction materials and warehousing facilities, wholesale and retail trade, workshops and other industrial and commercial activities. There are more than 60 different companies established in Thilafushi, the number is more likely to get higher each year. There are both foreigners and locals employed in the island.

354. **Infrastructure facilities.** Desalinated water is supplied in bulk to the doorstep of each plot by the Maldives Water and Sewerage Company (MWSC), who operate a 150 m<sup>3</sup>/day desalination plant on the island. There are also some small private desalination plants operating on the island. There is a high percentage of plots that use rainwater as the main source of drinking water. Drinking water is usually obtained from rainwater and desalinated water. Based on the socio-economic survey conducted in August – September 2019, 415 respondents confirmed they have flush latrine connected to a piped sewer system. Field surveys shows that 31% of the plots had their toilets connected to the sea and 68% had septic tank systems. There is no organized waste collection and management system on the island. Each tenant is responsible for daily and periodic waste collection and disposal to the dump site located on southern side of the island.

355. The main emergency services on the island the Fire Services and Police. The fire service is operated by Maldives National Defence Force (MNDF) 24 hours a day and is equipped to counter small to moderate fire events. The island is patrolled by the Maldives Police Services.

356. **Transportation.** The access to Thilafushi could be made by a ferry joining the capital Malé and operating every 30 minutes. Like other Islands Thilafushi is accessible through some docking points for speed boats and vessels. There is no other public transportation on the island. Transportation could be organized with the help of WAMCO, GMLZ or other private parties by car or lorries.

357. **Power Sources and Transmission.** Power is provided by the State Electric Company (STELCO) and from private generators (diesel generator sets). There is no exclusivity provision for STELCO as is the case in inhabited islands. However, 80% of the plots use STELCO electricity.

358. **Agriculture Development and Tourism.** Thilafushi is dedicated to industrial development and has no strategy and plans to become an agriculture or tourism island.

## 2. Social and Cultural Resources

359. **Population and Communities.** According to the 2014 census, there were 2,052 persons in Thilafushi Island. The total number of males and females are 2,048 and 4, respectively. Out of the 2,052 persons on the island, 333 persons were Maldivian. The dominant age group is 20-24 years comprising about a quarter of the population.

**Table 31: Living population at Thilafushi**

Total			Maldivian			Foreigners		
Both sexes	Male	Female	Both sexes	Male	Female	Both sexes	Male	Female
2,052	2,048	4	333	332	1	1,719	1,716	3

360. There are no communities/residential areas in Thilafushi. The island is an industrial zone. A socio-economic survey was conducted in August to September 2019 as the Government of Maldives does not have an updated database that could describe the socio-economic conditions

in the island. The overall objective of the survey is to ascertain the baseline socio-economic profile of the workers in Thilafushi and residents in Gulhifalhu Islands. The survey also provides insight on the population's needs, current waste disposal practices and the willingness of the companies to pay for waste management services. A complete report of this socio-economic survey is attached as Appendix 13.

361. The survey was carried out using random sampling and two questionnaires, one questionnaire for individuals working and/or residing in Thilafushi and Gulhifalhu and the other for companies based on these islands. Four hundred and thirty (430) individuals and 35 companies were surveyed across Thilafushi and Gulhifalhu Islands. Respondents were mainly located in Thilafushi. Spatial distribution of these surveyed workers and companies in the islands are illustrated in Figure 82 and Figure 83 below.

**Table 32: Number of Individuals Surveyed**

Island	Individuals	Percentage	Males	Females
Thilafushi	374	86.98%	373	1
Gulhifalhu	56	13.02%	56	0
<b>Total</b>	<b>430</b>	<b>100%</b>	<b>99.77%</b>	<b>&lt; 1%</b>

**Table 33: Number of Companies Surveyed**

Island	Companies	Percentage	Males	Females
Thilafushi	32	91.43%	31	1
Gulhifalhu	3	8.57%	3	0
<b>Total</b>	<b>35</b>	<b>100%</b>	<b>97.14%</b>	<b>2.86%</b>

**Figure 82: Spatial Distribution of Surveyed Workers in Thilafushi and Ghulee Fahlu.**



**Figure 83: Spatial Distribution of Surveyed Companies in Thilafushi and Ghulee Fahlu.**



362. As these islands are mainly used for manufacturing and industrial activities, respondents of the survey were predominantly male. There were only 2 female respondents, 1 for each of the individual and company questionnaires. The woman who responded to the individual questionnaire is 40 years old from Bangladesh living in Thilafushi in accommodation provided by the employer. The woman who responded to the company questionnaire is Maldivian and works for a company in Thilafushi that provides housing to their employees in Malé. Her company provides health insurance for their employees. Three employees from her company were reported to have health issues within the past year for fever and common cold. They sought medical attention in a health facility in Malé. The respondent believes that the practices of waste disposal in Thilafushi, including burning, is causing health issues to her and her employees.

363. There are 319 individuals surveyed that stay in Thilafushi and 52 stay in Gulhifahu, which totals 371. Of these, 367 or 98.92% are provided housing by their employers. As a result, the overwhelming majority of individuals surveyed that are staying in Thilafushi and Gulhifalhu are provided housing by their employers. The remaining respondents live in Malé (51) and in other islands such as Hulhumalé and Villimalé. Almost 89% of all respondents are provided housing by their employers.

**Table 34: Location of Accommodation of Individuals Surveyed**

Island	Number of Respondents	Percentage
Thilafushi	319	74.19%
Gulhifalhu	52	12.09%
Malé	51	11.86%
Other islands	8	1.86%
<b>Total</b>	<b>430</b>	<b>100%</b>

**Table 35: Housing Arrangement of Individuals Surveyed**

Housing	Number of Respondents	Percentage
Provided by employer	382	88.84%
Renting	39	9.07%
Own property	5	1.16%
Not paying rent	4	< 1%
<b>Total</b>	<b>430</b>	<b>100%</b>

364. The individuals surveyed range from 18 to 67 years old and are mostly Muslims (81%)

from Bangladesh (66%). The education level of the respondents' showed that 9% did not have any education, 12% had basic literacy skills, and 25% completed primary school. An estimate of 50% obtained secondary level education or higher but only 4% have completed a degree. Thus, an estimate of 56% of the respondents are unskilled laborers, 36% are skilled workers, 7% have a supervisor level position and <1% are managers. None of those surveyed are believed to be involved in fishing activities.

**Table 36: Age of Individual Respondents**

Age (years)	Number of Respondents	Percentage
18-29	186	43.26%
30-39	150	34.88%
40-49	68	15.81%
50-59	20	4.65%
60-67	6	1.40%
<b>Total</b>	<b>430</b>	<b>100%</b>

**Table 37: Religion of Individuals Surveyed**

Religion	Number of Respondents	Percentage
Islam	349	81.16%
Hinduism	53	12.33%
Buddhism	18	4.19%
Christianity	10	2.33%
<b>Total</b>	<b>430</b>	<b>100%</b>

**Table 38: Nationality of Individuals Surveyed**

Country of Nationality	Number of Respondents	Percentage
Bangladesh	283	65.81%
Maldives	66	15.35%
India	46	10.70%
Sri Lanka	23	5.35%
Nepal	10	2.33%
Indonesia	2	.47%
<b>Total</b>	<b>430</b>	<b>100%</b>

**Table 39: Education Level of Individuals Surveyed**

Education Level	Number of Respondents	Percentage
Secondary level and higher (non-degree)	216	50.23%
Primary level	108	25.12%
Basic literacy skills	50	11.63%
No education	37	8.60%
Degree level	19	4.42%
<b>Total</b>	<b>430</b>	<b>100%</b>

**Table 40: Employment Level**

Level	Number of Respondents	Percentage
Unskilled/ laborer	230	53.49%
Skilled/ expert	153	35.58%
Supervisor	32	7.44%
Manager	3	< 1%
Unknown	12	2.79%
<b>Total</b>	<b>430</b>	<b>100%</b>



365. Of the 35 companies surveyed, 18 did not provide detail on their type of business. The remaining 17 companies are engaged in the activities listed in Table 41. About 86% of companies surveyed reported that their employees are housed in Thilafushi and an estimate of 77% provide health insurance for their workers.

**Table 41: Types of Companies Surveyed**

Island	Business
Thilafushi	cooking
Thilafushi	tin sheet manufacturing
Thilafushi	sea and land transportation
Thilafushi	logistics
Thilafushi	boat repair and logistics
Thilafushi	water plant and electrical work
Thilafushi	Oil supplier; boat yard; port harbor; workshop
Thilafushi	garage
Thilafushi	tea shop
Thilafushi	repair and maintenance of heavy vehicles
Thilafushi	diesel seller
Thilafushi	boat building and repair
Thilafushi	police services
Thilafushi	cargo loading and unloading
Gulhifalhu	electricity provider
Gulhifalhu	island development
Gulhifalhu	storage and workshop

**Table 42: Location of Employee Housing**

Island	Number of Respondents	Percentage
Thilafushi	30	85.71%
Malé	4	11.43%
Gulhifalhu	1	2.86%
<b>Total</b>	<b>35</b>	<b>100%</b>

366. Twenty-four (24) or 69% of company respondents reported that they segregate their waste but only 10 or 29% stated that their waste is collected. Of those who reported that waste was collected from their company, collection frequency varied from daily to once a month. Thirteen (13) of the companies surveyed sell their recyclable waste.

367. Most of the laborers and companies are aware of the health issues related to inadequate waste management. The employers surveyed believe that the present waste disposal practices in Thilafushi affect their health and the health of their employees. The main reason was pollution due to burning of waste. Twenty-one (21) companies reported that they pay for waste disposal. However, of these, 18 reported that they were poorly satisfied with the waste collection services.

368. Of the total company respondents, 25 companies have stated their willingness to pay a higher amount than what they're currently paying for improved waste collection services. The survey found that smoke inhalation is perceived to be the main problem as the smoke can at times impair the visibility in Thilafushi. There are no fishing activities within the study area.

369. **Health Facilities.** Nearby healthcare facilities and hospitals are located in Malé. A health facility was opened in Thilafushi only recently in July 2019. However, the facilities and services offered are limited.

370. **Education Facilities.** There is no evidence of education facilities on Thilafushi. Nearby schools, high schools and other education facilities are located in Malé.

371. **Physical Cultural Resources.** No evidence of physical and cultural heritage could be found at Thilafushi. Similarly, no evidence of historical or archeological sites could be found at Thilafushi.

372. **Current use of land resources for traditional purposes.** No evidence of current use of land for traditional purposes could be found at Thilafushi.

373. **Sensitive Receptors.** Based on the results of the socio-economic survey (see discussion of survey results above), individuals were assessed if they will be directly affected negatively by the WTE project at any point during its implementation. Further, the extent of impact, if any, of the WTE project to these individuals was also assessed.

374. Assessment of the results of the survey show that the most sensitive receptor individuals are those workers who are employed without security of tenure and the elderly (65 years old and above). However, the project does not have influence or control over these individuals, nor will the project have impact on them. Summary of this assessment is in Table below:

**Table 43: Assessment of Project Impacts to Potential Sensitive Receptors**

<b>Criteria Based on ADB SPS</b>	<b>Findings in the Survey</b>	<b>Impact of the Project</b>
Below Poverty Line / Poor	The individuals surveyed are all employed at various positions and levels, from managerial positions to unskilled laborers.	None. The project will not cause displacement of workers in the island. Neither will the project impact the workers who may or may not be classified as belong to below the poverty line.
Female-headed HH	Not applicable. All workers including women in the island stay in housing or accommodation provided by employers. The island is not a residential area, and the status of determining households as female-headed or not is not applicable in this case.	None.
Landless or Without Legal Title to Land	Not applicable. All workers in the island stay in housing or accommodation provided by employers. The status of being landless or without legal title to land is not applicable in this case.	None. The project has not or will not displace any individual or entity with ownership to land or property. The project site is owned by the government (a reclaimed land) and no legal or illegal settlement exists on this site.
Elderly and Persons with Disabilities	No individuals surveyed were found to have disabilities.  The senior citizen age in the Maldives is 65 years old. Of the 430 individuals surveyed, only 2 individuals are 65 years old or above. Both are laborers who perceive their economic status to be	None.

Criteria Based on ADB SPS	Findings in the Survey	Impact of the Project
	middle income level. One lives in Malé and the other lives in Thilafushi in housing provided by their employer.	
Security of Employment	The majority of those surveyed stated that they have work permits. However, 51 foreign individuals (not Maldivian) surveyed have reported that they do not have work permits or visas.	None. The project does not have any control on the vulnerability of these workers who may lose their jobs at any time. Likewise, the project does not impact the viability of the companies where these workers are employed.
Indigenous Peoples	None.	None.

375. The workers who are currently working at the dumpsite are contractually or permanently employed by WAMCO. Once the WTE Project operates and the dumpsite stops operation, these workers will still be working as WAMCO employees and may be assigned to other works SWM operations.

#### H. Additional Baseline Data Gathering.

376. During the detailed design phase of the project, the baseline survey shall be conducted to include monthly baseline data on ambient air quality, and quarterly groundwater quality and marine water quality. The DBO Contractor shall undertake progressive monitoring and sampling activities during this period to ensure robust baseline data and pre-works environmental conditions are documented. The results of the baseline survey are considered in the final detailed design of the project. In particular, the DBO Contractor shall:

- (i) undertake ambient air quality measurements, marine water quality analysis, and marine underwater ecology survey for each season of the year at the identified sampling locations in this EIA report (and any other locations in and around Thilafushi island as may be deemed by the DBO Contractor as important sampling locations);
- (ii) follow required sampling methodologies and locations, including appropriate averaging time for ambient air quality measurements as indicated in the WHO Ambient Air Quality Guidelines; and
- (iii) include results of analyses in the updating of the EIA during the detailed design phase and consider these results in the final detailed design of the project as applicable.

## VI. ANTICIPATED ENVIRONMENTAL IMPACTS AND MITIGATION MEASURES

### A. Overview of Anticipated Impacts and Mitigation Measures

377. Potential environmental impacts of the proposed WTE Plant for Project area in Thilafushi are presented in this section. Mitigation measures to minimize and/or mitigate negative impacts, if any, are recommended along with the agency responsible for implementation. Monitoring actions to be conducted during the implementation phase are also recommended to reduce the impact.

378. Potential environmental impacts are categorized into four categories considering subproject phases: location impacts, design impacts (pre-construction phase), construction phase impacts, and operations and maintenance phase impacts.

379. Location impacts include impacts associated with site selection and include loss of on-site biophysical array and encroachment either directly or indirectly on adjacent environments. It also includes impacts on people who will lose their livelihood or any other structures by the development of that site.

380. Design impacts include impacts arising from project design, including technology used, scale of operation/throughput, fly ash and bottom ash production, discharge specifications, pollution sources and ancillary services.

381. Construction impacts include impacts caused by site clearing, earthworks, machinery, vehicles and workers. Construction site impacts include erosion, dust, noise, traffic congestion and waste production.

382. Operation and maintenance impacts include impacts arising from the operation and maintenance activities of the infrastructure facility. These include routine management of operational waste streams, and occupational health and safety issues.

383. Screening of environmental impacts has been based on the impact magnitude (negligible/moderate/severe – in the order of increasing degree) and impact duration (temporary/permanent).

384. As mentioned earlier, the project will be implemented under a Design-Build-Operate (DBO) contract and the detailed design phase will be carried out by the selected DBO Contractor. Hence, the impacts are based on the preliminary design prepared for the purpose of this EIA.

385. This section identifies the possible project-related impacts, in order to identify issues requiring further attention. ADB SPS requires that impacts and risks during pre-construction, construction and operational stages should be analyzed in the context of the project's area of influence.

## **B. Impacts Due to Location of Project**

386. The location of the project is in the proximity of the dumpsite at Thilafushi. Thilafushi is an industrial island with the oldest and largest landfill in the country and host to numerous industrial companies. The WTE plant and ancillary facilities will be developed on 27 hectares of which 15 hectares have been reclaimed from shallow lagoon. The old dumpsite will be closed and remediated when the WTE plant becomes operational.

387. Locating the WTE project in Thilafushi will reduce environmental risks associated with locating the project in another site or island, especially when the dumpsite is to be rehabilitated in the future anyway (impacts are limited to only one area, rather than in two areas). At the same time, Thilafushi is an industrial island and no residential areas will be affected. Therefore, no negative impacts are envisaged because of the location of the project.

## **C. Impacts Due to Physical Integrity of the Site**

388. The physical integrity of proposed project site cause serious damage to the WTE Plant is not considered in the final detailed design of the project. In order to ensure the integrity of

infrastructures of the WTE Plant, there is also a need to ensure the integrity of the project site itself. The Ministry of Environment will be responsible for undertaking a geotechnical study on the site and the DBO Contractor will ensure the WTE Plant infrastructure design considers the results of the geotechnical study. The DBO Contractor will also be responsible for undertaking a climate risk and vulnerability assessment on the site and ensure the WTE Plant infrastructure design considers the results of the assessment.

#### D. Impacts Due to Design of Project

389. Many aspects of the WTE Plant operations will negatively impact the environment if no proper measures are included or integrated in the detailed design of components of the plant. This section discusses all the design considerations that will be included in the final detailed design to ensure no adverse impact occur to the environment.

390. **Performance Guarantees.** Simultaneous with the preparation and conduct of EIA, the project has already undertaken preliminary steps to ensure it will not impact the environment significantly during its operations. As a project to be awarded under a DBO arrangement, a number of important measures have been proposed in the bidding and DBO contract documents. The bid document shall ensure that it requires the DBO contractor to meet the following performance requirements that will ensure the project will comply with applicable environmental standards as discussed in Section III hereof:

**Table 44: WTE Plant Performance Requirements Per DBO Bid Document Related to Environmental Safeguards**

Parameters	Performance Requirements <sup>a</sup>
Performance Guarantee (PG) 6: Total organic carbon-content bottom ash (TOC)	The Contractor shall ensure that the annual averaged TOC content of bottom ash shall be less than 3.0% by weight while none of the samples shall be with a TOC greater than 3.5%. The average TOC content shall be determined by analyzing two representative samples monthly (i.e. approximately one sample every 15 days). None of the measured TOC contents shall exceed 3.5% by weight dry matter. Measurement of TOC according to British Standard EN 131317. Six samples per year tested by external accredited laboratory.
PG 7: Temperature of cooling water outlet	The Contractor shall design and build the plant so that the cooling water outlet temperature shall be less than 3 degrees Celsius above receiving water and less than 38 degree Celsius.
PG 8: Air emission standards	The Contractor shall operate the plant so that none of the half hourly and none of the daily aggregated pollutants' measurements and none of the discontinuously measured pollutants' concentrations exceed the limits stipulated in Annex VI of Directive 2010/75/EU of the European Parliament and the Council (Technical Provisions Relating to emission standards for waste incineration plants and waste co-incineration plants any time. Measurement will be done thru CEMS and calibrated every third year (at least) by an accredited laboratory or certification agency.
PG 9: Combustion conditions	The Contractor shall ensure that combustion conditions (temperature = 850 degrees Celsius for at least 2 seconds residence time) are maintained at all times. The requirements as per Chapter 5.16 (Permits and Licenses to be Obtained) of the bidding document shall be considered, which specifies the trial operations and performance guarantees test. Combustion conditions include the need for proof by Contractor of maintaining the temperature and residence time, by submitting a methodology for how to validate that residence time and temperatures are kept under most unfavorable conditions.

	Combustion conditions shall be met any time during tests to be done on the completion of WTE plant construction and thereafter.																																																																				
PG 10: Leachate treatment plant (LTP) discharge standards	<p>The maximum permissible concentrations of pollutants discharged from the LTP into the environment are specified in the bidding document, which lists the effluent standards that should be complied with:</p> <table border="1"> <thead> <tr> <th>Parameters</th> <th></th> <th>unit</th> <th>Limit</th> </tr> </thead> <tbody> <tr> <td>Chemical Oxygen demand</td> <td>COD</td> <td>mg/l</td> <td>200</td> </tr> <tr> <td>Biological Oxygen demand</td> <td>BOD<sub>5</sub></td> <td>mg/l</td> <td>20</td> </tr> <tr> <td>Total Inorganic Nitrogen</td> <td>N<sub>tot, inorg</sub></td> <td>mg/l</td> <td>70</td> </tr> <tr> <td>Nitrite</td> <td>NO<sub>2</sub>-N</td> <td>mg/l</td> <td>2</td> </tr> <tr> <td>Sulfide</td> <td>S</td> <td>mg/l</td> <td>1</td> </tr> <tr> <td>Total Phosphate</td> <td>P<sub>tot</sub></td> <td>mg/l</td> <td>3</td> </tr> <tr> <td>Lead</td> <td>Pb</td> <td>mg/l</td> <td>0.5</td> </tr> <tr> <td>Cadmium</td> <td>Cd</td> <td>mg/l</td> <td>0.05</td> </tr> <tr> <td>Total Chromium</td> <td>Cr</td> <td>mg/l</td> <td>0.5</td> </tr> <tr> <td>Chromium (VI)</td> <td>Cr VI</td> <td>mg/l</td> <td>0.1</td> </tr> <tr> <td>Mercury (total)</td> <td>Hg</td> <td>mg/l</td> <td>0.02</td> </tr> <tr> <td>Nickel</td> <td>Ni</td> <td>mg/l</td> <td>1</td> </tr> <tr> <td>Zinc</td> <td>Zn</td> <td>mg/l</td> <td>2</td> </tr> <tr> <td>Copper</td> <td>Cu</td> <td>mg/l</td> <td>0.5</td> </tr> <tr> <td>Arsenic</td> <td>As</td> <td>mg/l</td> <td>0.1</td> </tr> <tr> <td>Conductivity at 25°C*</td> <td>-</td> <td>μS/ cm</td> <td>2,500</td> </tr> </tbody> </table> <p>*used to monitor the performance of the LTP only</p>	Parameters		unit	Limit	Chemical Oxygen demand	COD	mg/l	200	Biological Oxygen demand	BOD <sub>5</sub>	mg/l	20	Total Inorganic Nitrogen	N <sub>tot, inorg</sub>	mg/l	70	Nitrite	NO <sub>2</sub> -N	mg/l	2	Sulfide	S	mg/l	1	Total Phosphate	P <sub>tot</sub>	mg/l	3	Lead	Pb	mg/l	0.5	Cadmium	Cd	mg/l	0.05	Total Chromium	Cr	mg/l	0.5	Chromium (VI)	Cr VI	mg/l	0.1	Mercury (total)	Hg	mg/l	0.02	Nickel	Ni	mg/l	1	Zinc	Zn	mg/l	2	Copper	Cu	mg/l	0.5	Arsenic	As	mg/l	0.1	Conductivity at 25°C*	-	μS/ cm	2,500
Parameters		unit	Limit																																																																		
Chemical Oxygen demand	COD	mg/l	200																																																																		
Biological Oxygen demand	BOD <sub>5</sub>	mg/l	20																																																																		
Total Inorganic Nitrogen	N <sub>tot, inorg</sub>	mg/l	70																																																																		
Nitrite	NO <sub>2</sub> -N	mg/l	2																																																																		
Sulfide	S	mg/l	1																																																																		
Total Phosphate	P <sub>tot</sub>	mg/l	3																																																																		
Lead	Pb	mg/l	0.5																																																																		
Cadmium	Cd	mg/l	0.05																																																																		
Total Chromium	Cr	mg/l	0.5																																																																		
Chromium (VI)	Cr VI	mg/l	0.1																																																																		
Mercury (total)	Hg	mg/l	0.02																																																																		
Nickel	Ni	mg/l	1																																																																		
Zinc	Zn	mg/l	2																																																																		
Copper	Cu	mg/l	0.5																																																																		
Arsenic	As	mg/l	0.1																																																																		
Conductivity at 25°C*	-	μS/ cm	2,500																																																																		
PG 11: Wastewater treatment discharge standards	<p>The maximum permissible concentrations of pollutants discharged from the wastewater treatment plant into the environment are specified in the table of effluent standard for wastewater (see also <b>Table 13</b> of EIA report):</p> <table border="1"> <thead> <tr> <th>Parameters</th> <th></th> <th>unit</th> <th>Threshold Value</th> </tr> </thead> <tbody> <tr> <td>Chemical Oxygen demand</td> <td>COD</td> <td>mg/l</td> <td>150</td> </tr> <tr> <td>Biological Oxygen demand</td> <td>BOD<sub>5</sub></td> <td>mg/l</td> <td>40</td> </tr> <tr> <td>Suspended Solids</td> <td>-</td> <td>mg/l</td> <td>100</td> </tr> <tr> <td>Ammonia-N</td> <td>NH<sub>4</sub></td> <td>mg/l</td> <td>15</td> </tr> <tr> <td>Total N</td> <td>N</td> <td>mg/l</td> <td>30</td> </tr> <tr> <td>N-hexane extract (mineral oils, grease)</td> <td>-</td> <td>mg/l</td> <td>10</td> </tr> </tbody> </table>	Parameters		unit	Threshold Value	Chemical Oxygen demand	COD	mg/l	150	Biological Oxygen demand	BOD <sub>5</sub>	mg/l	40	Suspended Solids	-	mg/l	100	Ammonia-N	NH <sub>4</sub>	mg/l	15	Total N	N	mg/l	30	N-hexane extract (mineral oils, grease)	-	mg/l	10																																								
Parameters		unit	Threshold Value																																																																		
Chemical Oxygen demand	COD	mg/l	150																																																																		
Biological Oxygen demand	BOD <sub>5</sub>	mg/l	40																																																																		
Suspended Solids	-	mg/l	100																																																																		
Ammonia-N	NH <sub>4</sub>	mg/l	15																																																																		
Total N	N	mg/l	30																																																																		
N-hexane extract (mineral oils, grease)	-	mg/l	10																																																																		
PG 12: Sound pressure level	Sound pressure levels shall not exceed the 80 dBA at 1 min distance from the emitting source and different sound pressure levels at the site boundary: 70 dBA from 0700 to 2200 hours and 50 dBA from 2200 to 0700 hours. Measurement will be in-situ using decibel meter. Frequency of measurement specified in the EMP.																																																																				

<sup>a</sup> Performance standards from the Maldives Environmental Protection Agency and international guideline values as specified in EU Directives are compared and whichever is more stringent is applicable.

**391. Air Pollution Control (APC) system.** The WTE Plant shall be equipped with dry flue gas cleaning with a reactor, sodium bicarbonate injection and limestone, activated carbon injection, bag filter and selective non-catalytic reduction (SNCR) for nitrogen oxides. The APC system shall be designed so that bypass operations are not required.

- (i) Flue gas cleaning.
  - a. The reactor shall be designed so that flue gases, sodium bicarbonate, limestone and activated carbon are mixed efficiently.
  - b. For the regulation of the flue gas temperature, a quench with water shall be provided.
  - c. The residues from the landfill leachate treatment shall be disposed of via the reactor.
  - d. The bag house filter shall be designed with a maximum filter surface area load of 0.8 m<sup>3</sup>/m<sup>2</sup> min. and a maximum operation temperature of 200°C.
  - e. The pressure loss shall be smaller than 14 mbar.
  - f. The bag filter shall be equipped for fully automated and controlled (by differential pressure measurement) cleaning of the filter hoses by compressed air impulses.
  - g. The separated dust shall be transported via a water-cooled discharge screw into a big-bag filling station. The filled big bags shall be stored in a separate area of the adjacent landfill.
- (ii) Nitrogen oxide removal system.
  - a. The NO<sub>x</sub>-removal system shall be a SNCR.
  - b. With a SNCR-system, ammonia water with ammonia content < 25% or a water-urea-solution shall be injected in the first pass of the boiler at a temperature level of approximately 900°C.
  - c. The system shall be required with 3 levels of injection nozzles in the first boiler pass.
  - d. The tank for the ammonia water shall be an unpressurized vessel with a capacity of 30m<sup>3</sup>.

**392. Continuous Emission Monitoring System (CEMS).** For each of the stacks (i.e. incineration train), the DBO Contractor shall design and supply a CEMS with the following requirements:

- (i) Include the necessary flue gas sampling points for the emission measurements. The flue gas sampling points shall be located at an appropriate height above the ground that shall allow easy access.
- (ii) In addition to the continuously measured parameters covered in the performance guarantees, the pressure, flue gas temperature and flow, oxygen, water and carbon dioxide concentration shall be also continuously measured.
- (iii) The flue gas samples shall be routed via heated pipes to avoid condensation under all operating conditions to the measuring room or a measuring container.
- (iv) The analyzers shall be installed in cabinets. In addition, a computer and the holders for the test gas cylinders (zero gases and calibration gases), sample gases and carrier gases shall be arranged in the measuring room.
- (v) The measuring room or container, respectively, shall be air-conditioned.

- (vi) The analyzers shall be equipped with a periodically self-calibrating system using the test and calibrating gas. Each analyzer shall be provided with a suitable measurement range to allow the collection of emission data beyond the half hourly emission standards without compromising the accuracy in its lower measurement range.
- (vii) The measuring instruments used shall comply with EN 14181 and EN 15267 or US EPA CFR 11 Part 60 and Part 75.
- (viii) Raw emission data shall be compiled by the emission evaluation program to facilitate emissions statements according to the regulatory requirements.
- (ix) The emissions computer shall be equipped with special software, e.g. according to DIN EN 16258, which fulfils the following requirements:
  - a. Formation of overage values
  - b. Correction calculation for O<sub>2</sub>, temperature, pressure and flue gas humidity
  - c. Simultaneous calculation of the concentration
  - d. Archiving the raw data and the classified averages values with date and time stamp for stamp minimum 5 years.
- (x) All measurement results shall be forwarded to the DCS and be displayed in the central control room. Subject to the requirements of the EPA, the emission data shall be also transmitted to EPA.

393. **Dust control system.** Notwithstanding the obligation to limit the dust emissions from the stack, the DBO Contractor shall design and build the facilities to prevent any dust emissions due to unloading, loading, landfilling or conveying and processing any dust prone materials such as bottom ash, chemicals for the APC system, APC residues etc. Any potential explosion hazard due to a dust laden environment shall be prevented. Subject to the considerations of the DBO Contractor, the design shall consider wherever appropriate measures such as, but not limited to:

- (i) Covering all conveyors to prevent materials to be blown away by wind;
- (ii) Using dust free bulk loading chutes during unloading or loading;
- (iii) Dust free filling from or discharging into jumbo bags;
- (iv) Using dust filter to remove dust from an exhaust;
- (v) Minimizing drop height of automatic unloading or discharging systems; and
- (vi) Operating dust laden atmosphere under sub-atmospheric pressure.

394. Signage to instruct the DBO Contractor's personnel of any potentially dust laden area and to use protection equipment shall be provided.

395. **Odor control system.** Odor emission from the plant may be due to handling waste, wastewater or chemicals (such as urea or ammonia). The DBO Contractor shall apply appropriate measures in the design of the plant such as but not limited to:

- (i) Operating odorous atmospheres under sub-atmospheric pressure and deodorizing the atmosphere by using it as primary air for the combustion system (e.g. bunker, tipping hall):
- (ii) Monitoring the continuous operation of ventilating systems (fans) and alarming in the event of failures;
- (iii) Using gas tight connectors while unloading urea/ammonia; and
- (iv) Providing an efficient and sufficient aeration to the wastewater treatment.

396. The DBO Contractor shall determine the potential fugitive and localized emission sources and shall submit these jointly with the odor control concept during the concept design phase.



397. **Landfill system.** The DBO Contractor shall ensure that the design of the residual waste landfill will be able to accommodate the volume of all generated incinerator bottom ash and fly ash during the entire operation of the WTE Plant, with the assumption that no bottom ash will be recycled and/or reused. The DBO Contractor shall include in the design the following criteria:

- (i) The landfill arrangement shall be designed to maximize the useable landfill volume of the site;
- (ii) The residual waste landfill cell arrangements shall be designed to allow for the progressive closure of individual landfill cells on completion and thereby to minimize the amount of leachate requiring treatment over the lifetime of the landfill;
- (iii) The design shall allow for the development of individual cells in a coherent and logical sequence and in a manner, which ensures the stability of all working faces and of the waste mound as a whole.
- (iv) The design shall incorporate appropriate back-up systems in the event of failure of any component of the environmental control and management systems;
- (v) The residual waste landfill concept shall be designed to minimize the lateral and vertical extent of the working face and thereby the amount of deposited waste (bottom ash and fly ash) that is exposed to the environment;
- (vi) The design shall ensure that residual waste can be deposited in a manner that prevents damage to the engineered barrier or liner, the leachate control system, and the collection and transfer system.
- (vii) The residual waste landfill design shall incorporate an internal access corridor to allow for safe traffic movement and to accommodate site services and monitoring devices;
- (viii) Measures shall be provided for controlling unauthorized access to the residual waste landfill including, as appropriate, the provision of ditches, berms, planting and fencing;
- (ix) Slopes shall be graded to ensure long term slope stability. Graded slopes shall be a maximum of 25%;
- (x) Soil erosion and dust generation shall be minimized;
- (xi) All residual waste landfill construction materials shall be free of organic matter and debris; and
- (xii) Measures shall be provided to monitor and manage groundwater beneath and adjacent to the residual waste landfill area.

398. With reference to the waste characteristics in Table 1, the wastes have the potential to contain hazardous substances. Therefore, both the bottom ash and fly ash may likewise contain these hazardous substances that could impact the environment if no sufficient measures are taken to contain them. In order to avoid this impact, the DBO Contractor shall design the residual waste landfill facility by applying international best practices on landfilling of hazardous wastes, such as the relevant requirements indicated in the EU Directive on the Landfill of Wastes.<sup>32</sup> Table 45 below summarizes these requirements.

**Table 45: General Requirements for Hazardous Waste Landfills**

Design Parameters	Design Considerations and Requirements
Water control and leachate management	Appropriate measures shall be taken, with respect to the characteristics of the landfill and the meteorological conditions, in order to: <ol style="list-style-type: none"> <li>(i) control water from precipitations entering into the landfill body,</li> </ol>

<sup>32</sup> Council Directive 1999/31/EC of 26 April 1999 on the Landfill of Waste.

Design Parameters	Design Considerations and Requirements												
	<ul style="list-style-type: none"> <li>(ii) prevent surface water and/or groundwater from entering into the landfilled waste,</li> <li>(iii) collect contaminated water and leachate,</li> <li>(iv) treat contaminated water and leachate collected from the landfill to the appropriate standard required for their discharge following Table 13 of this EIA report.</li> </ul>												
Protection of soil and water	<p>The landfill must be situated and designed so as to meet the necessary conditions for preventing pollution of the soil, groundwater or surface water and ensuring efficient collection of leachate as and when required. Protection of soil, groundwater and surface water is to be achieved by the combination of a geological barrier and a bottom liner during the operational/active phase and by the combination of a geological barrier and a bottom liner during the operational/active phase and by the combination of a geological barrier and a top liner during the passive phase/post closure.</p> <p>The geological barrier is determined by geological and hydrogeological conditions below and in the vicinity of a landfill site providing sufficient attenuation capacity to prevent a potential risk to soil and groundwater.</p> <p>The landfill base and sides shall consist of a mineral layer which satisfies permeability and thickness requirements with a combined effect in terms of protection of soil, groundwater and surface water at least equivalent to the one resulting from the following requirements:</p> <ul style="list-style-type: none"> <li>- landfill for hazardous waste: <math>K \leq 1.0 \times 10^{-9}</math> m/s; thickness <math>\geq 5</math> m,</li> </ul> <p>Where the geological barrier does not naturally meet the above conditions, it can be completed artificially and reinforced by other means giving equivalent protection. An artificially established geological barrier should be no less than 0.5 meters thick.</p> <p>In addition to the geological barrier described above a leachate collection and sealing system must be added in accordance with the following principles so as to ensure that leachate accumulation at the base of the landfill is kept to a minimum.</p> <table border="1" data-bbox="427 1291 1409 1522"> <thead> <tr> <th colspan="3" style="text-align: center;"><i>Leachate collection and bottom sealing</i></th> </tr> <tr> <th style="text-align: center;">Landfill category</th> <th style="text-align: center;">non hazardous</th> <th style="text-align: center;">hazardous</th> </tr> </thead> <tbody> <tr> <td>Artificial sealing liner</td> <td style="text-align: center;">required</td> <td style="text-align: center;">required</td> </tr> <tr> <td>Drainage layer <math>\geq 0,5</math> m</td> <td style="text-align: center;">required</td> <td style="text-align: center;">required</td> </tr> </tbody> </table> <p>If the DBO Contractor finds that the prevention of leachate formation is necessary, a surface sealing may be prescribed. Recommendations for the surface sealing are as follows:</p>	<i>Leachate collection and bottom sealing</i>			Landfill category	non hazardous	hazardous	Artificial sealing liner	required	required	Drainage layer $\geq 0,5$ m	required	required
<i>Leachate collection and bottom sealing</i>													
Landfill category	non hazardous	hazardous											
Artificial sealing liner	required	required											
Drainage layer $\geq 0,5$ m	required	required											

Design Parameters	Design Considerations and Requirements		
	Landfill category	non hazardous	hazardous
Gas drainage layer		required	not required
Artificial sealing liner		not required	required
Impermeable mineral layer		required	required
Drainage layer > 0,5 m		required	required
Top soil cover > 1 m		required	required.
Nuisances and hazards	<p>Measures shall be taken to minimize nuisances and hazards arising from the landfill through:</p> <ul style="list-style-type: none"> <li>- emissions of odors and dust,</li> <li>- wind-blown materials,</li> <li>- noise and traffic,</li> <li>- birds, vermin and insects,</li> <li>- formation and aerosols,</li> <li>- fires.</li> </ul> <p>The residual waste landfill shall be equipped with appropriate form of physical barriers so that dirt originating from the site is not dispersed onto public roads and the surrounding land.</p>		
Stability	<p>The emplacement of waste on the site shall take place in such a way as to ensure stability of the mass of waste and associated structures, particularly in respect of avoidance of slippages. Where an artificial barrier is established it must be ascertained that the geological substratum, considering the morphology of the residual waste landfill, is sufficiently stable to prevent settlement that may cause damage to the barrier.</p>		
Barriers	<p>The residual waste landfill shall be secured to prevent free access to the site. The gates shall be locked outside operating hours. The system of control and access to each facility should contain a program of measures to detect and discourage illegal dumping in the facility.</p>		

399. **Storm water collection system.** The DBO Contractor's design shall include surface water and storm water collection and diversion systems in order to protect the residual waste landfill area and minimize the generation of leachate. Sedimentation ponds shall be established to contain polluted drainage and runoff containing soil and sediment.

400. **Leachate treatment system.** The DBO Contractor shall ensure that design of the Leachate Treatment Plant (LTP) will also follow applicable requirements in the EU Directive on Landfill of Wastes as enumerated in Table 45 in order to prevent leachate contamination of marine water and groundwater. In addition to these requirements, the DBO Contractor shall also include the following requirements in the design of the LTP:

- (i) An acid and alkali resistant floor finish shall be provided for all sections of the leachate treatment facility that may be exposed to acid or lye;
- (ii) A drainage system shall be provided to collect liquids, spills etc. that is connected to the site's sewer system;
- (iii) A collection and disposal system shall be provided for reverse osmosis rinsing and flushing liquids;

- (iv) The necessary IT linkage shall be made to the site's LAN and telephone network and linkage to the DCS network;
- (v) The level of the engineered barrier shall be no deeper than 1.5 meters above mean sea level and in accordance with the applicable environmental standards;
- (vi) The leachate collection system shall provide for the progressive installation of control measures for the management of leachate;
- (vii) The design shall ensure that piping is not blocked by sedimentation, debris, algal or fungal growth and that structural integrity is maintained at all times;
- (viii) The system shall be capable of dealing with the maximum leachate flow at any time during the lifespan of the landfill;
- (ix) Leachate shall be treated to meet the effluent discharge standards;
- (x) The design shall provide for the segregation of surface water from leachate;
- (xi) The design and selection of materials for the leachate management and storage system and location of discharge point into the sea shall be discussed with, and approved by, the Maldives EPA;
- (xii) The design shall provide a suitable system for the transfer of leachate from the collection system to the leachate treatment plant;
- (xiii) Leachate levels shall be monitored continuously and shall be capable of being read electronically; and
- (xiv) The leachate treatment system shall be capable of running automatically between and above specified leachate levels and volumes.

401. All components of the leachate collection, extraction, transfer and treatment system shall be capable of being maintained in a clean condition to ensure effective operation. Concentrate may be re-injected in the flue gas treatment process of the WTE plant. The Contractor shall design and build or organize a system for the re-injection of the LTP concentrate.

402. **Wastewater treatment system.** An on-site wastewater treatment plant will be provided to treat the wastewater generated from floor/vehicle washing and from staff/visitors. The treated effluent will be reused in the incineration plant or for washdown and landscape irrigation within the facility. Efforts will be taken so that no effluent would be discharged to the ground or sea. Should wastewater be discharged, the DBO Contractor shall ensure the design of the wastewater treatment plant will comply with the effluent standards in Section III hereof and consistent with the applicable performance guarantee in the DBO Contract as indicated in Table 44.

## E. Impacts on Marine Protected Areas

403. Thilafushi is still the largest waste management center in greater Malé and more widely in Project area and beyond. The impacts of waste to the marine environment through transferring or disposing still continues. This problem is exacerbated as the current situation lacks proper docking facilities and infrastructure. Further, toxic components of general waste and particularly ELVs are poorly managed and risks of contaminating surrounding water are high. Improvements to the waste vessel harbor and facilities enabling handling of large containers carrying waste from within Greater Malé and around Project area will reduce this risk.

404. There are three marine protected areas (MPAs) located near the project site. Illustration and maps showing the proximity of these MPAs are in Figure 79. The details of the sites are provided in Table 46 below.

**Table 46: Protected areas in the vicinity of Thilafushi**

Name	Type	Notes	Location relative to project site
------	------	-------	-----------------------------------

Dhekunu Thilafalhuge Miyaruvani (Lions Head)	Reef	Situated on the reef face of the outer atoll, favored dive spot	Immediate Southwest of Thilafushi Island at a distance of around 1km from the project site.
Gulhee Falhu Kollavaani (Hans Hass Place)	Reef	Deep lagoon area	East of Gulhifalhu Island, 0.4km to the East of Thilafushi Island, and 2km from the project site.
Giraavaru Kuda Haa	Reef	Isolated reef approximately 30m above lagoon floor	4 km North (NNE) of Thilafushi Island.

405. The Lions Head is the closest and the most vulnerable MPA for this project. This is a famous dive site as many gray reef sharks were seen from this site. However, big fishes are not seen as often as it was in the past. On the steep outside, the reef has caves, colorful washouts and overhangs at about 10m of depth. From the 7 marine location surveys conducted for this EIA, live corals were found along the reef where Lion Head is located. Other areas mainly consisted of rock and rubble. The Maldives EPA is currently considering reclassifying “Dhekunu Thilafalhuge Miyaruvani” from Protected Landscape/seascape (IUCN Category V) to Protected Area with sustainable use of Natural resources (IUCN Category VI), in terms of reflecting current land use in the surrounding areas and conserve ecosystems and habitats, together with associated cultural values and traditional, natural resource management.

406. The dive site Hans Hass place located about 2km from the project. It is expected that the project will have no impact to this site knowing the distance and Gulhee Fahlu island that encloses it from the western side where Thilafushi is located. Giraavaru Kuda Haa is located about 4 km north from the project site. It expected that no direct impact will be caused to this MPA due to the distance and location.

407. The construction activities that will have impact on the marine environment includes laying the discharge pipes for brine, sewerage and cooling water from the incinerators, construction of the coastal protection measures and berth. Moreover, the project site consists of a recently reclaimed land. The construction impacts are discussed in the section on construction phase impacts and operational phase impacts.

408. The overall potential impact for this location due to the project will be long term, positive and significant and will cover both the immediate area around the islands and the wider marine environment in Project area and beyond.

## **F. Impacts on Groundwater and the Terrestrial Environment**

409. Thilafushi Island is an artificial island and therefore, any vegetation present is from weed colonization and tree planting efforts by the different existing locators (industrial and commercial). Furthermore, there are no trees in or in the close proximity of the project site.

410. The groundwater in Thilafushi is presumed to be highly contaminated from the leachate generated from the open waste dumpsite. Baseline data for the quality of ground water in the island are documented in this EIA report and will serve as reference in future monitoring activities under the project. The quality of the groundwater is expected to be better after the remediation of the dumpsite (although not part of the project that is subject of this EIA). Therefore, the impact will be positive, significant and long-term.

## G. Impacts on Avifauna

411. The birds attracted to the island as well as water birds that frequent surrounding waters will benefit from both the improved handling and treatment to remove hazardous fractions onto the landfill or into surrounding waters. The beneficial effect will be significant and long-term.

## H. Impacts on Critical Habitats

412. In order to assess whether the WTE project is located in a critical habitat, an initial screening was undertaken using the Integrated Biodiversity Assessment Tool (IBAT).<sup>33</sup> Results show that the location of the WTE project is likely a critical habitat. Therefore, a critical habitat assessment is needed to confirm the results. Critical habitat assessment ideally takes place across sensible ecological or political units that are sufficiently large to encompass all direct and indirect impacts from the project. These areas of analysis (AoAs) are thus often much broader than the direct project footprint. AoAs may be separate or combined, depending on the ecology of the biodiversity concerned. Considering the extent of potential impacts on aquatic biodiversity from the project, an aquatic AoA for the project was identified as the 50-km study area to make consistent with the default range in the IBAT Screening. This area is approximately within the Zone 3 of Maldives, within which common biological communities and/or management issues exist.

413. The critical habitat assessment considered if critical habitat-qualifying biodiversity candidates or species identified in the IBAT Screening are actually or potentially present within the AoA. The IFC Guidance Note 6 (2019)<sup>34</sup> has been used to identify if a certain biodiversity candidate or species can qualify the project AoA as Critical Habitat. Reasons are identified for each biodiversity feature likely meeting or not meeting Critical Habitat.

414. Results confirmed that the site is likely a critical habitat only for one terrestrial insect (identified as *Enallagma maldivensis*). As discussed in this EIA report, the insect thrives in freshwater environment. Therefore, this particular species is highly unlikely to be present within or around the vicinity of the WTE project site. However, as a precautionary measure, the critical habitat assessment and EIA recommend continuous monitoring around Thilfushi island to confirm the extent of biodiversity in various seasons of the year, including assessment of features pertinent to critical habitats. As part of the detailed design, the DBO contractor in coordination with PMU will be required to undertake additional biodiversity assessment around the project site. This is to ensure pre-construction works conditions and biodiversity risks are considered in the design, construction and operation, and to examine and mitigate the potential impacts of the project on areas significant for biodiversity. In cases when future information determines the existence of critical habitat, the WTE project should be able to demonstrate that:

---

<sup>33</sup> The Integrated Biodiversity Assessment Tool (IBAT) is a multi-institutional programme of work involving BirdLife International, Conservation International, IUCN, and UNEP-WCMC. IBAT provides a basic risk screening on biodiversity. It draws together information on globally recognised biodiversity information drawn from a number of IUCN's Knowledge Products: IUCN Red List of Threatened Species, Key Biodiversity Areas (priority sites for conservation) and Protected Planet/The World Database on Protected Areas (covering nationally and internationally recognised sites, including IUCN management categories I–VI, Ramsar Wetlands of International Importance and World Heritage sites).

<sup>34</sup> [https://www.ifc.org/wps/wcm/connect/5e0f3c0c-0aa4-4290-a0f8-4490b61de245/GN6\\_English\\_June-27-2019.pdf?MOD=AJPERES&CVID=mRQjZva](https://www.ifc.org/wps/wcm/connect/5e0f3c0c-0aa4-4290-a0f8-4490b61de245/GN6_English_June-27-2019.pdf?MOD=AJPERES&CVID=mRQjZva)

- (i) It does not lead to measurable adverse impacts on those biodiversity values for which the critical habitat was designated, and on the ecological processes supporting those biodiversity values;
- (ii) It does not lead to a net reduction in the global and/or national/regional population of any Critically Endangered or Endangered species over a reasonable period of time; and
- (iii) It has integrated into its management program a robust, appropriately designed, and long-term biodiversity monitoring and evaluation program.

## I. Impacts on Socio-Cultural Resources

415. **Loss of land and effects on property.** No private property will be affected, and no land acquisition will be required. No encroachment to any private property is expected at any stage of the project implementation. The project will utilize its own land, including the lands and ports of WAMCO, during the design and mobilization stage of the project.

**Table 47: Summary of impacts based on location**

Potential Impact	Assessment
Marine environment and ecosystem	Long term, Beneficially significant
Groundwater and terrestrial environment	Long term, Beneficially significant
Avifauna	Long term, Beneficially significant
Land and effects on property	NIL

## J. Impacts During Construction Phase

### 1. Air Pollution and Noise

416. Air pollution sources during the construction phase will consist of vehicular pollution, and pollution from machineries used in construction work, which will release exhaust and cause dust to be produced. The ambient levels of air pollution at the site is already very high. The released pollutants are not expected to remain stagnant to any particular area as the site is close to the coast on both sides and therefore the pollutants would be dispersed.

417. Similar to the sources of air pollution, noise and vibrations generated in the construction site also caused by the operation of machinery, equipment and vehicles. As there are few residents living in Thilafushi and they do not live in close proximity to the project site, the impacts on human life in minimal. Furthermore, the residents in this environment are engaged in industrial activity.

418. The impacts of air pollution, noise and vibrations although negative, will be temporary and not significant during construction.

### 2. Water Pollution and Impacts to Marine Environment

419. Impacts on the marine environment during the construction will largely be from the construction of the berth and the discharge pipes for hot water from the incinerator and the utilities such as sewerage and brine from desalination. The berth is proposed to be located at the enclosed lagoon in the island. Excavation in the area will results in sedimentation. As this semi-enclosed area is quite stagnant, settlement rate will be higher than an area with regular currents and water flow. This will also be short lived as the size and scale small, if excavation is required. The marine survey conducted for this EIA shows that this area mostly consists or rock and rubble

and hardly any live coral. Therefore, impacts for coral due to sedimentation is negligible. The discharge pipes will be directed towards the South into deep sea. As some live corals are located in this area, according to the marine survey, pipes should be laid during calm sea conditions, with as much care as is feasible.

420. Sea vessels can cause risks of water pollution, in the events of leaks and spills of fuel, lubricants, hydraulic fluids or other fluids used for vehicle operation. These may be hazardous waste. Although this area is already contaminated, care should be taken to mitigate the risks and impacts of any spills of hazardous waste. Although these impacts will be negative, it is short term and not significant.

### **3. Waste Generation**

421. Waste generation will be expected during the construction phase. Expected wastes will include packaging of construction materials, equipment, fuels, lubricants, food and some rubble where existing structures need to be demolished. Mitigation measures for handling and disposal of these wastes are included in the EMP. Some specialist lubricants and paint may be hazardous. These will also be disposed of at the appropriate locations following the measures in the EMP. For toxic materials, approvals must be obtained from appropriate agency prior to importing materials rated as hazardous under the Globally Harmonized System of Classification and Labelling of Chemicals. Therefore, the potential impact is not significant.

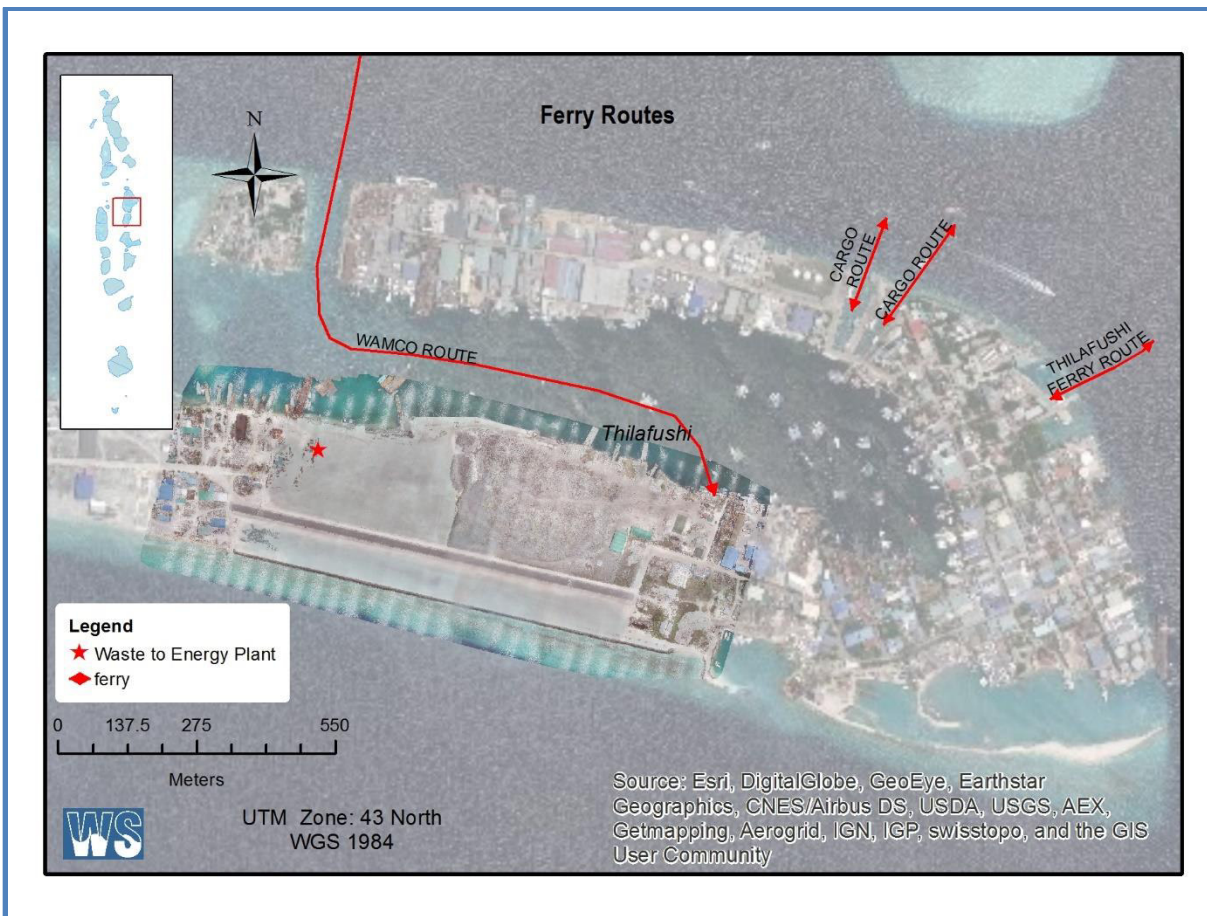
### **4. Land-based and Marine Traffic Congestion**

422. As there are few vehicles on Thilafushi, there will be no significant impact on land-based traffic. All vehicle and heavy equipment movements during construction phase will only be limited within the boundary of the project site.

423. Delivery of construction equipment and raw materials may increase marine traffic in the area. In order to avoid this impact, all delivery of equipment during mobilization phase and raw materials for the construction activities will be utilizing the exclusive docking ports of WAMCO, which are near or adjacent the project site. These docking ports or quays are where current solid wastes are unloaded from various parts of Project area. With this scheme, it is expected that no marine traffic and port congestion are expected that will affect the locator industries and workers at the island. Figure 84 below shows the marine route that will be utilized during construction and operation phase of the project. The figure also shows the location of docking ports of workers going in and out of the island, including the docking ports of ferries and other private marine vehicles.

**Figure 84: Marine Traffic Route and Docking Port for the Project**





## 5. Community and Occupational Health and safety

424. Impacts and risks for community and occupational health and safety are associated with heavy equipment in trafficked areas. The DBO contractor will be required to appoint a full-time environmental health and safety managers and maintain a pool of trained engineers to ensure the effective implementation of both environmental and occupational health and safety measures at the project site. The DBO Contractor shall establish its health and safety plan to be adopted at the site following international best practices and the World Bank EHS guidelines on construction and decommissioning activities. The DBO contractor has the responsibility to provide labor camps for migrant workers, and sufficient space for equipment, construction materials, consumables, and other supplies that will be required during construction phase. Office policies, benefits, facilities and compensations should not be distinguished between migrant and non-migrant workers.

425. During the detailed design phase, the DBO Contractor shall integrate international good practices on community and occupation health and safety in its construction methods and practices, such those included in ADB SPS and Section 4.2 of World Bank EHS Guidelines on Construction and Decommissioning activities.<sup>35</sup> Minimum requirements shall be the following:

### Community Health and Safety

<sup>35</sup> IFC World Bank Group. 2007. Environmental, Health, and Safety (EHS) Guidelines – General EHS Guidelines: Construction and Decommissioning.

- (i) identify and assess the risks to, and potential impacts on, the safety of affected communities during the design, construction, operation, and decommissioning of the project, and will establish preventive measures and plans to address them in a manner commensurate with the identified risks and impacts;
- (ii) avoid or minimize the exacerbation of impacts caused by natural hazards, such as landslides or floods, that could result from land use changes due to project activities;
- (iii) inform affected communities of significant potential hazards in a culturally appropriate manner;
- (iv) be prepared to respond to accidental and emergency situations. This preparation will include response planning document(s) that addresses the training, resources, responsibilities, communications, procedures, and other aspects required to respond effectively to emergencies associated with project hazards. Appropriate information about emergency preparedness and response activities, resources, and responsibilities will be disclosed to affected communities;
- (v) engage qualified and experienced experts, separate from those responsible for project design and construction, to conduct a review as early as possible in project development and throughout project design, construction, and commissioning. This will ensure that structural elements or components situated in high-risk locations will not fail or malfunction and threaten the safety of communities;
- (vi) implement risk management strategies to protect the community from physical, chemical, or other hazards associated with sites under construction and decommissioning;
- (vii) restricting access to the site, through a combination of institutional and administrative controls, with a focus on high risk structures or areas depending on site-specific situations, including fencing, signage, and communication of risks to the local community;
- (viii) removing hazardous conditions on construction sites that cannot be controlled affectively with site access restrictions, such as covering openings to small confined spaces, ensuring means of escape for larger openings such as trenches or excavations, or locked storage of hazardous materials; and
- (ix) implement measure to prevent proliferation of vectors of diseases at work sites;
- (x) adequate space and lighting, temporary fences, shining barriers and signage at active work sites;
- (xi) contractor's preparedness in emergency response;
- (xii) adequate dissemination of GRM and contractor's observance and implementation of GRM; and
- (xiii) upon availability, local people should be given an opportunity for work in the project activities.

### **Occupational Health and Safety**

- (i) Communication and Training
  - (a) Training of all workers on occupational health and safety prior to construction works;
  - (b) Conduct of orientation to visitors on health and safety procedures at work sites;
  - (c) Signages strategically installed to identify all areas at work sites, including hazard or danger areas;

- (d) Proper labeling of equipment and containers at construction and storage sites; and
  - (e) Suitable arrangements to cater for emergencies, including: first aid equipment; personnel trained to administer first aid; communication with, and transport to, the nearest hospital with an accident / emergency department; monitoring equipment; rescue equipment; firefighting equipment; and communication with nearest fire brigade station;
- (ii) Physical Hazards
- (a) Use of personal protective equipment by all workers such as earplugs, safety shoes, hard hats, masks, goggles, etc. as applicable, and ensure these are used properly;
  - (b) Avoidance of slips and falls through good house-keeping practices, such as the sorting and placing loose construction materials or demolition debris in established areas away from foot paths, cleaning up excessive waste debris and liquid spills regularly, locating electrical cords and ropes in common areas and marked corridors, and use of slip retardant footwear;
  - (c) Use of bracing or trench shoring on deep excavation works;
  - (d) Adequate lighting in dark working areas and areas with night works;
  - (e) Rotating and moving equipment inspected and tested prior to use during construction works. These shall be parked at designated areas and operated by qualified and trained operators only;
  - (f) Specific site traffic rules and routes in place and known to all personnel, workers, drivers, and equipment operators; and
  - (g) Use of air pollution source equipment and vehicles that are well maintained and with valid permits;
- (iii) General Facility Design and Operation
- (a) Regular checking of integrity of workplace structures to avoid collapse or failure;
  - (b) Ensuring workplace can withstand severe weather conditions;
  - (c) Enough workspaces available for workers, including exit routes during emergencies;
  - (d) Fire precautions and firefighting equipment installed;
  - (e) First aid stations and kits are available. Trained personnel should be available at all times who can provide first aid measures to victims of accidents;
  - (f) Secured storage areas for chemicals and other hazardous and flammable substances are installed and ensure access is limited to authorized personnel only;
  - (g) Good working environment temperature maintained;
  - (h) Worker camps and work sites provided with housekeeping facilities, such as separate toilets for male and female workers, drinking water supply, wash and bathing water, rest areas, and other lavatory and worker welfare facilities; and
  - (i) Maintain records and make reports concerning health, safety and welfare of persons, and damage to property. Take remedial action to prevent a recurrence of any accidents that may occur.

426. **Construction Camps.** The construction camp site and accommodation of workers shall be established following international best practices to ensure welfare of workers is protected.<sup>36</sup> The DBO Contractor shall consider the following requirements, whichever are applicable, in building these camps and accommodation facilities at the site, if any.

- (i) The temporary campsite location should:
  - (a) Be free from any risk of flooding.
  - (b) Be sited a reasonable distance and have clear physical separation from any construction work, equipment and/or machinery.
  - (c) Provide clear separation between the camp and construction area through such means as a footpath, fence, etc.
  - (d) Where possible, be sited outside the boundary of the construction zone.
- (ii) The site design should ensure:
  - (a) Adequate space to accommodate the number of workers throughout the project period, for accommodation, meals, toilets, bathing, etc.
  - (b) Considerations for needs of all types of workers: e.g. women, local laborers or travelers, etc.
  - (c) Adequate drainage is provided to prevent any stagnant water which can attract mosquitos and vermin and spread disease among workers,
  - (d) Buildings are structurally sound and can withstand wind and rain.
  - (e) Ensure that the worker camp area will have adequate ground surfacing (e.g. gravel, wood sheeting, grass) such that residents may move freely between buildings in their off time without walking through mud and water.
  - (f) Designated area for small fires during colder months, located a safe distance from buildings and any flammable materials.
- (iii) The workers' accommodation should comply with the following requirements:

#### **Dimensions and Design**

- (a) The height of room shall not be less than 2.4 meters.
- (b) The sleeping area or resting area shall not be less than 3 m<sup>2</sup> per person.
- (c) Separate bed for each worker provided, with minimum of 1 meter space between each bed.
- (d) Separate sleeping areas are provided for men and women, except in family rooms if needed.
- (e) Sleeping area should be separate from cooking/canteen areas, and far enough distance from toilets to avoid odors.
- (f) Where possible, prefab-type structures could be considered.

#### **Light and Air**

---

<sup>36</sup> From the draft Construction Code of Practice developed for urban development projects in Kathmandu, Nepal. This COP was developed with reference to the following: "Workers' accommodation: processes and standards: A guidance note by IFC and EBRD", IFC and EBRD, 2009 [https://www.ebrd.com/downloads/about/sustainability/Workers\\_accomodation.pdf](https://www.ebrd.com/downloads/about/sustainability/Workers_accomodation.pdf); and "Malaysian standards of temporary construction site workers' amenities and accommodation – code of practice. (MS 2593, 2015) [http://www.sirim.my/srhc/documents/Aug-Sept-2014/12D024R0\\_PC.pdf](http://www.sirim.my/srhc/documents/Aug-Sept-2014/12D024R0_PC.pdf)

- (a) Both natural and artificial lighting are provided and maintained in living facilities. It is best practice that the window area represents not less than 5% to 10% of the floor area. Emergency lighting is provided.
- (b) For cold weather months, accommodation must be such that the temperature is kept at a level of around 20 degrees Celsius notwithstanding the need for adequate ventilation.
- (c) In warmer months, adequate ventilation (either cross-ventilation and/or fans) is provided.

### **Materials**

- (a) Roofing materials must be such that the structure can withstand high winds without risk of collapse and be leak-free during rainy season.
- (b) Flooring material should be easily cleanable and free of bare nails or other sharp objects.

### **Provisions/furnishing**

- (a) Each worker is provided with a comfortable mattress, pillow, cover and clean bedding.
  - (b) Double or triple-deck bunk beds are prohibited. Double deck bunks may be used in special circumstances but must be approved by the Engineer or competent person of the DBO Contractor.
  - (c) Each resident is provided facilities for the storage of personal belongings, such as a locker or shelving unit.
  - (d) Every resident is provided with adequate furniture such as a table, a chair, a mirror and a bedside light (small solar lights may be a good option). These may be shared among several workers.
  - (e) Separate storage provided for work boots and PPE. Drying/airing areas may need to be provided for PPE depending on conditions.
  - (f) Mosquito nets are provided in areas where mosquitos are present and/or at the request of workers.
  - (g) Rubbish bin with cover provided in each room and emptied regularly.
  - (h) Electrical outlets provided for charging mobile phones, radio, etc. Ensure that electrical wiring is done properly and presents no risk of electrical fire.
  - (i) All doors and windows should be lockable and be provided with mosquito screens.
- (iv) The workers kitchen area should comply with the following requirements:
- (a) The minimum area of kitchen should be not less than 4.5 m<sup>2</sup> and the minimum width should be more than 1.5 meters.
  - (b) Adequate height of kitchen should be not less than 2.25 meters.
  - (c) Provide where clean drinking water is always available – ensure that any open water tanks are covered.
  - (d) Kitchens are provided with facilities to maintain adequate personal hygiene including a sufficient number of washbasins designated for cleaning hands with clean water and materials for hygienic hand-drying.

- (e) In order to enable easy cleaning, it is good practice that cooking stoves are not sealed against a wall, and benches and fixtures are not built into the floor.
  - (f) Design should consider if the kitchen within the camp will be used to service all workers for all meals (e.g. meals prepared for day laborers as well as residents) or will be limited to self-preparation of meals by residents.
  - (g) Wall surfaces adjacent to cooking areas are made of fire-resistant materials.
  - (h) Food preparation tables are equipped with a smooth, durable, easily cleanable, non-corrosive surface made of non-toxic materials.
  - (i) All cupboards and other fixtures have a smooth, durable and washable surface.
  - (j) All kitchen floors, ceiling and wall surfaces adjacent to or above food preparation and cooking areas are built using durable, non-absorbent, easily cleanable, non-toxic materials.
  - (k) Cooking gas canisters provided
  - (l) Fire extinguisher provided outside of cooking area.
  - (m) Rubbish bin(s) provided with cover
  - (n) Adequate facilities for cleaning, disinfecting and storage of cooking utensils and equipment are provided.
- (v) The workers toilets should comply with the following requirements:
- (a) Toilets should be located within same general area as accommodation, but at least 30 meters away from sleeping area/kitchen. Should not be more than 60 m away.
  - (b) Toilets should be located at least 30 meters away from any water wells.
  - (c) An adequate number of toilets should be provided to workers. Standards range from 1 unit per 15 persons to 1 unit per 6 persons.
  - (d) Toilet rooms shall be located so as to be accessible without any individual having to pass through any sleeping room
  - (e) Toilet dimensions should be at least 1.5 m × 0.75 m (minimum width)
  - (f) Toilet facilities should be installed so as to prevent any odors reaching dining facilities or sleeping areas.
  - (g) Separate facilities provided for men and women.
  - (h) An adequate number of handwash facilities is provided to workers. Standards range from 1 unit per 15 persons to 1 unit per 6 workers. Handwash facilities should consist of a tap and a basin, soap and hygienic means of drying hands.
  - (i) Toilets should be constructed such that they are structurally sound during high winds and free from leaks during rains.
  - (j) Every toilet should be provided with natural lighting and natural ventilation by means of ≥ 1 openings, providing a total area of >0.2 m<sup>2</sup> per toilet. Such openings shall be capable of allowing a free, uninterrupted passage of air.
  - (k) In addition, all toilet rooms should be well-lit, with natural lighting and artificial lights at night.
  - (l) Ensure no discharge of toilets and showers that will contaminate water sources or common areas
  - (m) Sanitary and toilet facilities are designed to provide workers with adequate privacy, including ceiling to floor partitions and lockable doors
  - (n) Ensure toilets have rubbish bin in each cubicle

- (vi) The shower and washing facilities should comply with the following requirements:
- (a) An adequate number of shower facilities is provided to workers. Standards range from 1 unit per 15 persons to 1 unit per 6 persons.
  - (b) Shower/bathing facilities are provided with an adequate supply of clean water.
  - (c) Separate facilities for men and women.
  - (d) The flooring for shower facilities should be of hard washable materials, damp-proof and properly drained.
  - (e) Suitable light, ventilation and soap should be provided.
  - (f) Adequate space and hooks must be provided for hanging clothes/towels while bathing.
  - (g) Area for washing/drying clothes provided, including washbasin, soap and drying lines. Either piped water to the basin or standpipe for filling basins should be within close distance.
  - (h) Ensure area drains well and doesn't create a muddy environment.
- (vii) Optional Amenities and Other Good Practices that should be followed as applicable:
- (a) Paint the camp buildings to present a tidy and satisfactory appearance – this will help encourage workers to keep their camp in good condition.
  - (b) Provide signage in kitchen area, canteen, toilets, and other common areas to encourage good hygiene practices, cleanliness of kitchen and personal spaces, worker conduct, worker responsibilities, safety evacuation plan, etc.
  - (c) Involve laborers in design of the camp, e.g. to get their inputs on siting of buildings, and any specific needs of women.

**Table 48: Summary of Impacts During the Construction Phase.**

<b>Potential Impact</b>	<b>Assessment</b>
Water pollution to marine environment	Short term, negative, not significant
Air pollution and noise	Short term, negative, not significant
Waste generation	NIL
Land-based and Marine Traffic Congestion	Short term, minimal negative, not significant
Community and occupational health and safety	Short term, negative, not significant.

## **K. Impacts during Operational Phase**

### **1. Air Pollution Due to Emission from WTE Plant**

427. The DBO Contractor will finalize the detailed engineering design and O&M Manual based on the following:

- (i) Incorporation of EHS Guidelines on Waste Management Facilities<sup>37</sup> such as prevention, minimization and control of air emissions through:

<sup>37</sup> IFC World Bank Group. 2007. Environmental, Health, and Safety (EHS) Guidelines For Waste Management Facilities.

- a. Conduct of waste segregation and/or presorting, subject to feasibility or practicality, by collaborating with the waste supplier to avoid incineration of wastes that contain metals and metalloids that may volatilize during combustion and be difficult to control through air emission technology (e.g., mercury and arsenic). However, regardless of any practical waste segregation effort, the DBO Contractor shall ensure full and efficient functioning of the APC system of the WTE plant at all times;
- b. Follow applicable national requirements and internationally recognized standards for incinerator design and operating conditions, mainly rapid quenching of the flue gas after leaving all combustion chambers and before entering any dry particulate matter air pollution control device but also combustion temperature, residence time, and turbulence.<sup>38</sup> Standards for stationary incinerators which include temperature and afterburner exit gas quenching (i.e. rapid temperature reduction) requirements are preferred in order to nearly eliminate dioxins and furans. In case where rapid quenching is not practical for the WTE plant, follow applicable national requirements and internationally recognized standards for incinerator design and operating conditions, such as combustion temperature, residence time, turbulence, and reduced residence time of dust laden exhaust gases in the temperature range of 450 to 200 degrees Celsius;
- c. Introduce wastes into the incinerator only after the optimum temperature is reached in the final combustion chamber.
- d. The waste charging system should be interlocked with the temperature monitoring and control system to prevent waste additions if the operating temperature falls below the required limits;
- e. Minimize the uncontrolled ingress of air into the combustion chamber via waste loading or other routes;
- f. Optimize furnace and boiler geometry, combustion air injection, and, if used, NOx control devices using flow modeling;
- g. Optimize and control combustion conditions by the control of air (oxygen) supply, distribution and temperature, including gas and oxidant mixing; the control of combustion temperature level and distribution; and the control of raw gas residence time;
- h. Implement maintenance and other procedures to minimize planned and unplanned shutdowns;
- i. Avoid operating conditions in excess of those that are required for efficient destruction of the waste;
- j. Use auxiliary burner(s) for start-up and shut down and for maintaining the required operational combustion temperatures (according to the waste concerned) at all times when unburned waste is in the combustion chamber;
- k. Use a boiler to transfer the flue-gas energy for the production of electricity and/or supply of steam/heat, if practical;

---

<sup>38</sup> For example, according to Article 6 of EU Council Directive 2000/76, the gas resulting from the incineration process should be raised, after the last injection of combustion air to a temperature of 850 degrees Celsius (1,100 degrees Celsius for hazardous wastes with a content greater than 1% of halogenated organics) for a period of two seconds. Additional details on operating conditions are provided in this reference. Other sources of emissions standards include the U.S. EPA regulations for air emissions from stationary sources at 40 CFR Part 60.



- l. Use primary (combustion-related) NO<sub>x</sub> control measures and/or selective catalytic reduction (SCR) or selective noncatalytic reduction (SNCR) systems, depending on the emissions levels required;
- m. Use flue gas treatment system for control of acid gases, particulate matter, and other air pollutants;
- n. Minimize formation of dioxins and furans by ensuring that particulate control systems do not operate in the 200 to 400 degrees Celsius temperature range; identifying and controlling incoming waste composition; using primary (combustion-related) controls; using designs and operation conditions that limit the formation of dioxins, furans, and their precursors; and using flue gas controls;
- o. Consider the application of waste-to-energy to help off-set emissions associated with fossil fuel-based power generation.<sup>39</sup>

## 2. Analysis of Impacts Based on Stack Emission Dispersion Modeling

428. Municipal waste incineration produces various pollutants that can affect air quality and human health. These pollutants are released through two specific waste products of incineration process known as bottom ash and fly ash. These wastes can include a combination of various heavy metals, dioxins and furans, and other persistent organic pollutants. Specifically, fly ash is the more hazardous waste product due to size and density that can go airborne with the combustion gases when released to the atmosphere and impact air quality.

429. Heavy metals and dioxin and furans are highly toxic compounds which when inhaled or ingested by humans may in the long term cause cancer and neurological damage, congenital malformations and infant mortality, respiratory illnesses, etc. Hence, it is paramount that the adoption of incineration technology has to come with it an accompanying APC technology or process which will enable efficient recovery of these toxic pollutants. However, even with the most advance technologies to date, complete removal of these toxic substances in the flue gases is difficult to achieve. It is for this reason that good international industry practices and standards, such as the emission standards in Annex VI of Directive 2010/75/EU of the European Parliament and the Council, are established to ensure emissions from these specific facilities do not impact the ambient conditions of the environment. Concomitantly, height of stack from where emissions should be discharged needs to be calculated and followed to ensure pollutants from emissions do not degrade the ground level ambient air quality. Air dispersion modeling is normally used to simulate how air pollutants disperse in the atmosphere and to analyze the potential impacts of these pollutants to ambient air quality given specific project and site information.

430. **AUSTAL2000.** The dispersion modeling for the pollutants was carried out using the dispersion model AUSTAL2000. The computer program AUSTAL2000 is a reference implementation developed on behalf of the German Federal Environmental Agency.<sup>40</sup> It also available in English version as it is used by other EU-member states.by other EU-member states.

431. AUSTAL2000 calculates the spread of pollutants and odors in the atmosphere. It is an extended implementation of Annex 3 of the German regulation TA Luft (Technical Instruction on

<sup>39</sup> The possibility of applying waste-to-energy technologies depends on a number of issues which may include the project design specifications established by local government as well as laws applicable to the generation and sale electricity. Also, it should be noted that recycling options may often save more energy than what is generated by incineration of mixed solid waste in a waste-to-energy facility.

<sup>40</sup> Available as a free download at <https://www.umweltbundesamt.de/themen/luft/regelungen-strategien/ausbreitungsmodelle-fuer-anlagenbezogene/austal2000n-download>

Air Quality Control) demands for dispersion calculations using a Lagrangian particle model in compliance with the German guideline VDI 3945 Part 3. The modeling work was carried out by Ulbricht Consulting (Germany). The dispersion modeling report is attached as Appendix 5.

432. Steady-state Gaussian plume models assess pollutant concentrations and/or deposition fluxes from a variety of sources associated with an industrial source complex. Unlike the Gaussian models commonly used, this flexible modeling procedure used in AUSTAL2000 provides realistic results even when buildings and uneven terrain influence flue gas dispersion. The model calculates the contribution of specified air pollutants from a given point source to the background concentrations present in the ambient air at ground level in the area surrounding the source.

433. **Emission mass flow.** Using the calculation methodology from the German regulation TA Luft, the various substances potentially present in the emission coming out of the stacks use the mass concentration limits indicated in the said German regulation. Summary of resulting mass flows of each substance is outlined in Table 49 below.

**Table 49: Emission mass flow (for R = 115 713 m<sup>3</sup>/h, T = 180 °C, Ø = 2.12 m)**

Substance	Mass Concentration [24-hour]	Mass Flow Q in kg/h	Factor S	Q/S in kg/h <sup>a</sup>
Total dust, including particulate matter (No 5.2.1 TA Luft)	5 mg/m <sup>3</sup>	0.579	0.08	7.2
Fluorine and its compounds, indicated as hydrogen fluoride (5.2.4 Class II TA Luft)	1 mg/m <sup>3</sup>	0.116	0.0018	64.3
Gaseous inorganic chlorine compounds, indicated as hydrogen chloride (5.2.4 class III TA Luft)	10 mg/m <sup>3</sup>	1,157	0.1	11.6
Ammonia (5.2.4 class III TA Luft)	10 mg/m <sup>3</sup>	1,157	-	-
Sulfur oxides (sulfur dioxide and sulfur trioxide), expressed as sulfur dioxide (5.2.4 Class IV TA Luft)	50 mg/m <sup>3</sup>	5,786	0.1 4	41.3
Nitrogen oxides (nitrogen monoxide and nitrogen dioxide), expressed as nitrogen dioxide (5.2.4 (2), 2nd sentence TA Luft)	150 mg/m <sup>3</sup>	11,108*	0.1	111.08*
Carbon monoxide (5.2.4 para. 2 sentence 1 TA Luft)	50 mg/m <sup>3</sup>	5,786	7.5	0.77
Organic substances (expressed as total C) (TA Luft 5.4.10.20)	10 mg/m <sup>3</sup>	1,157	0.1	11.6
Mercury and its compounds, reported as Hg (No 5.2.2 Class I TA Luft)	0.03 mg/m <sup>3</sup>	0.00347	0.00 013	26.7
Dioxins and furans	0.1 ng/m <sup>3</sup>	0.0000000116	-	-
Sum of heavy metals and their components: antimony, chromium, copper, manganese, vanadium, tin, lead, cobalt, nickel (5.2.2 TA Luft class II and III)	0.5 mg / m <sup>3</sup>	0.05786	0.05 0.1	1.157 0.579
Thallium and its compounds (5.2.2 TA Luft class I) cadmium	0.05 mg / m <sup>3</sup>	0.00579	0.005	1.16

Substance	Mass Concentration [24-hour]	Mass Flow Q in kg/h	Factor S	Q/S in kg/h <sup>a</sup>
Arsenic / cadmium and its compounds (expressed as As and Cd), benzo (a) pyrene, water-soluble cobalt compounds (expressed as Co), chromium (VI) compounds (expressed as Cr) (5.2.7.1.1 TA Luft Class I)	0.05 mg / m <sup>3</sup>	0.00579	0.00005	115.7

<sup>a</sup> According to point 5.5.3 TA Luft, the emission of nitrogen monoxide is based on a conversion rate of 60% to nitrogen dioxide, and is based on a ratio of NO/NO<sub>2</sub> = 90%/10%, cf. Annex 1.1

434. **Control of the necessity for dispersion calculation.** Following the guidance and methodology in the German regulation TA Luft, the determination of the emission characteristics is not required if the emissions of the air pollutants do not exceed the minor mass flows indicated in the regulation. Table 43 below summarizes these minor mass flows in the regulation and compared with the expected WTE mass flow.

**Table 43: Minor Mass Flow According to TA Luft and WTE mass flow**

Pollutants	Minor mass flow	WTE mass flow
	in kg / h	
Emissions derived from stacks		
Dust (without consideration of dust contents)	1	0.579
Fluorine and its compounds, indicated as hydrogen fluoride (5.2.4 Class II TA Luft)	0.15	0.116
Gaseous inorganic chlorine compounds, indicated as hydrogen chloride (5.2.4 class III TA Luft)	-	1.157
Ammonia (5.2.4 class III TA Luft)	-	1.157
Sulfur oxides (sulfur dioxide and sulfur trioxide), expressed as sulfur dioxide (5.2.4 Class IV TA Luft)	20	5.786
Nitrogen oxides (nitrogen monoxide and nitrogen dioxide), expressed as nitrogen dioxide (5.2.4 (2), 2nd sentence TA Luft)	20	11.108
Carbon monoxide (5.2.4 para. 2 sentence 1 TA Luft)	-	5.786
Organic substances (expressed as total C) (TA Luft 5.4.10.20)	-	1.157
Mercury and its compounds, reported as Hg (No 5.2.2 Class I TA Luft)	0.0025	0.00347
Dioxins and furans	-	0.0000000116
Sum of heavy metals and their components: antimony, chromium, copper, manganese, vanadium, tin, lead, cobalt, nickel (5.2.2 TA Luft class II and III)	0.025 lead, nickel (class II)	0.05786
Thallium and its compounds (5.2.2 TA Luft Class I)	0.0025	0.00579
Arsenic / cadmium and its compounds (expressed as As and Cd), benzo (a) pyrene, water-soluble cobalt compounds (expressed as Co), chromium (VI) compounds (expressed as Cr) (5.2.7.1.1 TA Luft Class I)	0.0025	0.00579

435. From Table 43 above, most of substances the values are below the minor mass flows. For mercury as well as heavy metals and their components (referred to thallium and arsenic/cadmium and lead/nickel) the values are over the minor flows, therefore there is a need to perform the dispersion modeling for these substances.

436. For ammonia and hydrogen chloride (5.2.4 Class III TA Luft), for carbon monoxide, for organic substances (expressed as total C) as well as dioxins and furans no minor mass flow are set in the regulations therefore there is no need to undertake a detailed dispersion modeling for these parameters either.

437. **Emergency Gen-set.** For the emissions mass flow calculation of the air pollutants of the emergency Gen-set, data from PMU have been made available. The following pollutants have to be considered. The exhaust gas volume flow was given as  $V_n = 12\,470 \text{ m}^3/\text{h}$  and the exhaust gas temperature to  $T=180^\circ \text{ C}$ .

**Table 44: Minor mass flow according to Section 4.6.1.1 TA Luft - system mass flow**

Substance	Minor mass flow	Plant mass flow
	in kg / h	
Dust (without consideration of dust contents)	1	0.9976
Nitrogen oxides (nitrogen monoxide and nitrogen dioxide), expressed as nitrogen dioxide (5.2.4 (2), 2nd sentence TA Luft)	20	3.99
Carbon monoxide (5.2.4 (2) sentence 1 TA Luft)	-	.741
Formaldehyde - HCHO	-	0.748

438. The minor mass flows have also been not exceeded by the Gen-set emission values, so that no dispersion calculation has to be carried out for these substances. For carbon monoxide and formaldehyde no minor mass flow has been set in the regulation. For these substances, no dispersion calculation is to be carried out.

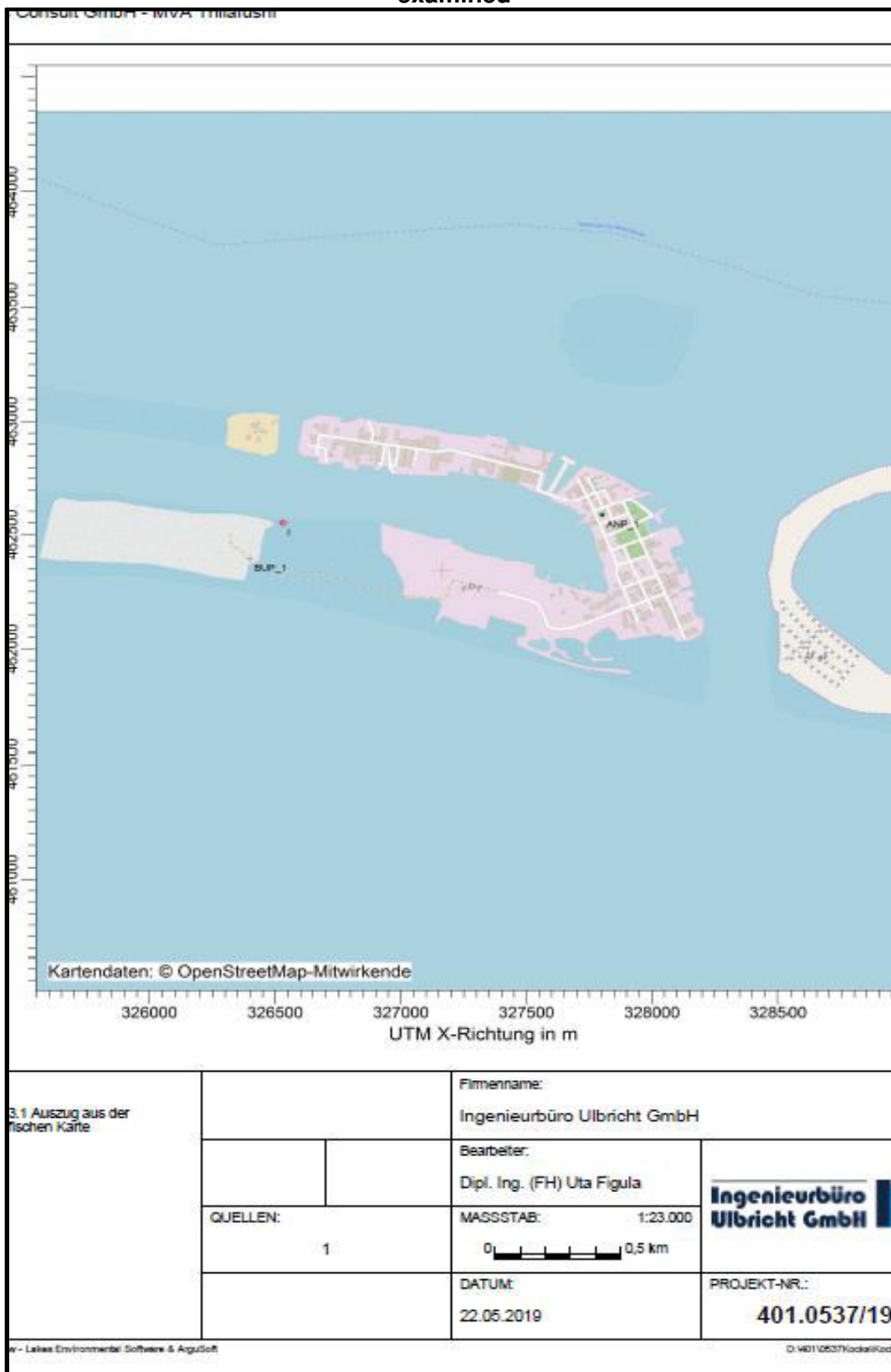
439. **Air dispersion modeling for relevant parameter.** In order to estimate exposures to airborne pollutants from the incineration and emergency electricity generation, dispersion modeling was carried out. Modeling was done for the pollutants from the emergency electricity generator sets, such as dust, nitrogen monoxide and nitrogen dioxide, carbon monoxide, and formaldehyde. Similarly, modeling was done for the pollutants from the WTE plant, such as total dust including fine dust, fluoride and its compound specified as hydrogen fluoride, ammonia, sulfur (sulfur dioxide and sulfur trioxide), specified as sulfur dioxide, nitrogen oxide (nitrogen monoxide and nitrogen dioxide) specified as nitrogen dioxide, and mercury and its compound specified as mercury. The study zone was defined as a 5,000 m radius of influence from incinerator stack at Thilafushi.

440. **Emission from installations.** The following emission sources have been considered:

- (i) Exhaust stack: WTE
- (ii) Operation time: 8,000 hours/year

441. **Emissions from guided sources.** For the incineration plant, the following pollutants have been taken into account in the dispersion calculation. The exhaust gas volume flow was given as  $V_n = 115,713 \text{ m}^3/\text{h}$  and the exhaust gas temperature as  $T = 180^\circ \text{ C}$ . The air dispersion calculation was made with a stack height of 46.0 m. Increasing the stack height to 50 m has been recommended. Therefore, the calculated emissions are presenting the worst case. With the extension of the stack, the ambient air concentration value will be reduced at the reception point.

Figure 85: Location of the emission points where maximum load was calculated and examined



442. The following results apply exclusively taking into account the characteristics of the emission sources as discussed above. While the dispersion calculation is required only for mercury, all other results in Table 45 are presented for information only. As a guide, a comparison is made with the irrelevance values of the Technical Instruction on Air Quality Management. The detailed calculation results and the grid diagram for the substance mercury are given in Appendix 5.

**Table 45: Ambient air quality additional charge (IZ) (including statistical uncertainty)**

Ambient air quality points			BUP 1	ANP 1
Substance	Irrel. IZ	IW		
Mercury g/(m <sup>2</sup> d)	0.05	1	0.007	1.0
PMDEP g/(m <sup>2</sup> d)	0.0105	0.35	0.0001	0.0001
PM10 µg/m <sup>3</sup>	1.2	40	0	0
Hydrofluoric µg/m <sup>3</sup>	0.04	0.4	0	0.005
Sulfur dioxide µg/m <sup>3</sup>	1.5	50	0	0.2
Nitrogen oxides µg/m <sup>3</sup>	1.2	40	0	0.4
Ammonia µg/m <sup>3</sup>	-		0	0.04
Lead µg/(m <sup>2</sup> d)	5	100	0.2	17.0
Nickel µg / (m <sup>2</sup> d)	0.75	15	0.122	17.1
Thallium µg / (m <sup>2</sup> d)	0.1	2	0.01	1.7
Cadmium µg / (m <sup>2</sup> · d)	0.1	2	0.01	1.7

443. A pre-pollution with air pollutants at the site is not known (baseline), so it is assumed that the calculated values represent the total load.

444. **Evaluation point BUP 1.** At assessment point BUP 1, the values are below the “irrelevance thresholds” of TA Luft for the substances.

445. **Analysis point ANP 1.** At the ANP 1 analysis point, the air pollutants PM10, dust precipitation, sulfur dioxide, nitrogen oxides, hydrogen fluoride fall below the irrelevance values according to TA Luft.

446. If an orienting comparison is made with the air quality values of TA Luft, the following can be stated:

- (i) For lead, thallium, cadmium, arsenic, the ambient air quality value of TA Luft is below. For mercury, the ambient air quality value of TA Luft is reached (not exceeded).
- (ii) The specified ambient air quality value in the TA Luft for nickel is exceeded. In the calculation, the heavy metal nickel was considered representative of the group of heavy metals and their components: antimony, chromium, copper, manganese, vanadium, tin, lead, cobalt, nickel (5.2.2 TA Luft class II and III).
- (iii) Taking into account the volumetric flow and the desired mass concentration (corresponding to the emission limit value (class II according to 5.2.2 TA Luft) for the group of heavy metals, the emission mass flow for the group of heavy metals was assigned to the substance nickel. From a technical perspective it is not expected that none of the further elements of the heavy metal group occur in the exhaust gas, so that the exceeding of the ambient air quality value for nickel is likewise not expected.

447. **Ammonia.** No ambient air quality value is specified for ammonia. The desired mass concentrations by means of flue gas cleaning are below the values specified in the TA Luft (limit values). A negative impact on the environment is therefore not expected.

448. **Hydrogen chloride, total C, carbon monoxide (CO), dioxins and furans.** No ambient air quality values are specified for these substances. The mass concentrations aimed at by means of flue gas cleaning are below the values stated in the TA Luft (limit values). A negative impact is therefore not to be feared.

**Figure 86: Additional Load Mercury-Deposit from the Dispersion Model.**

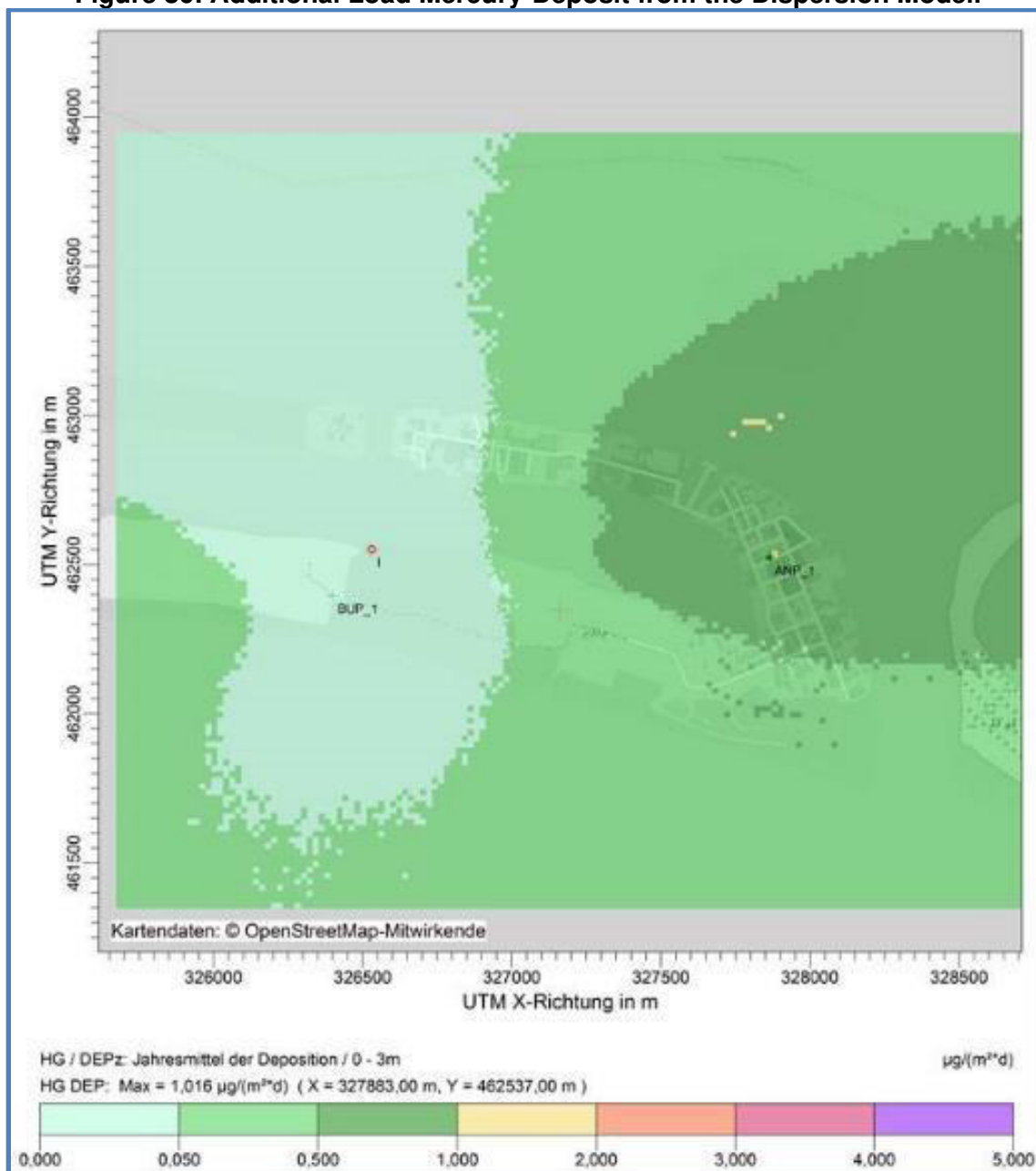


Figure 87: PM-Deposit from the Dispersion Model.

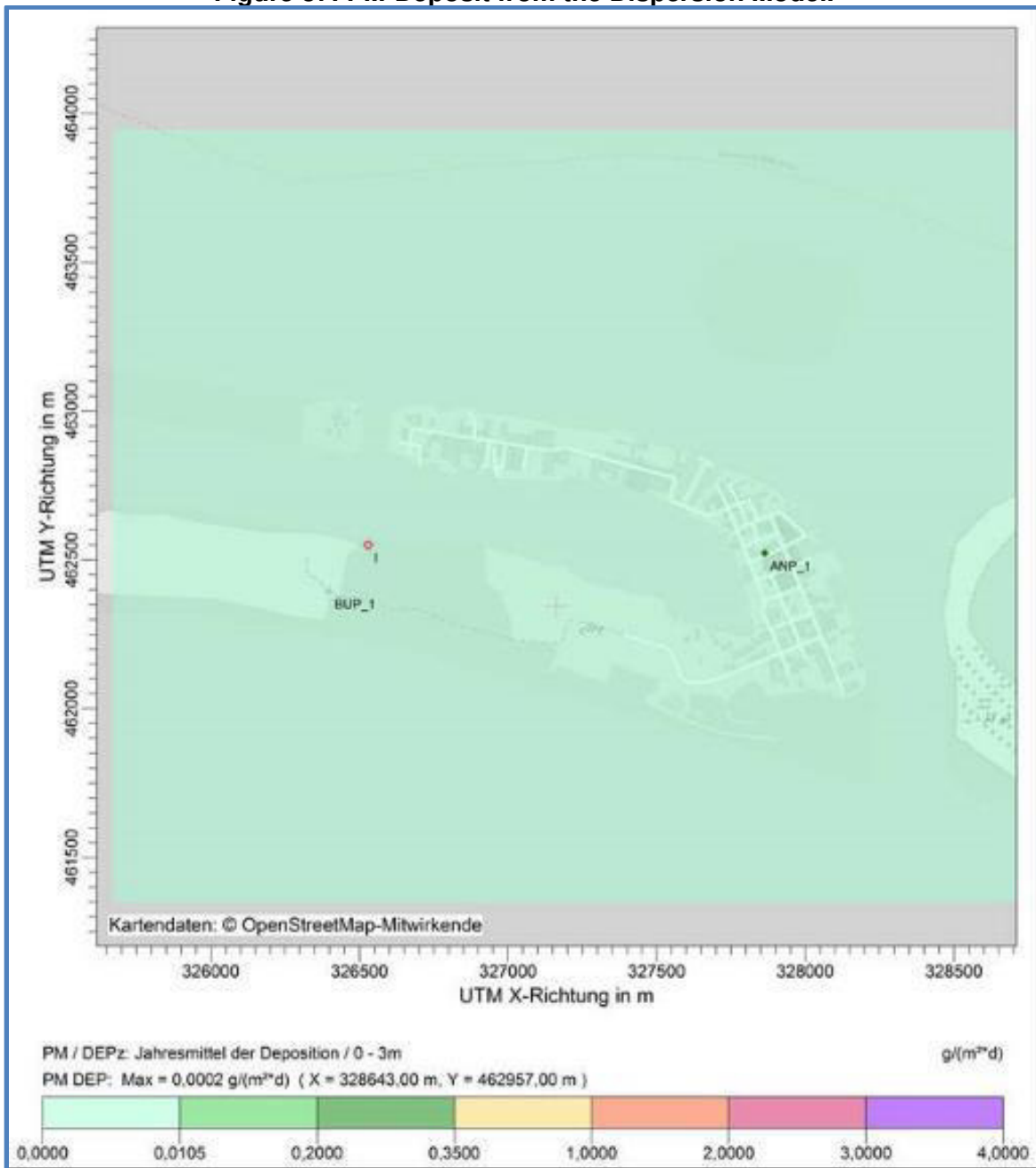




Figure 88: F-Deposit from the dispersion model.

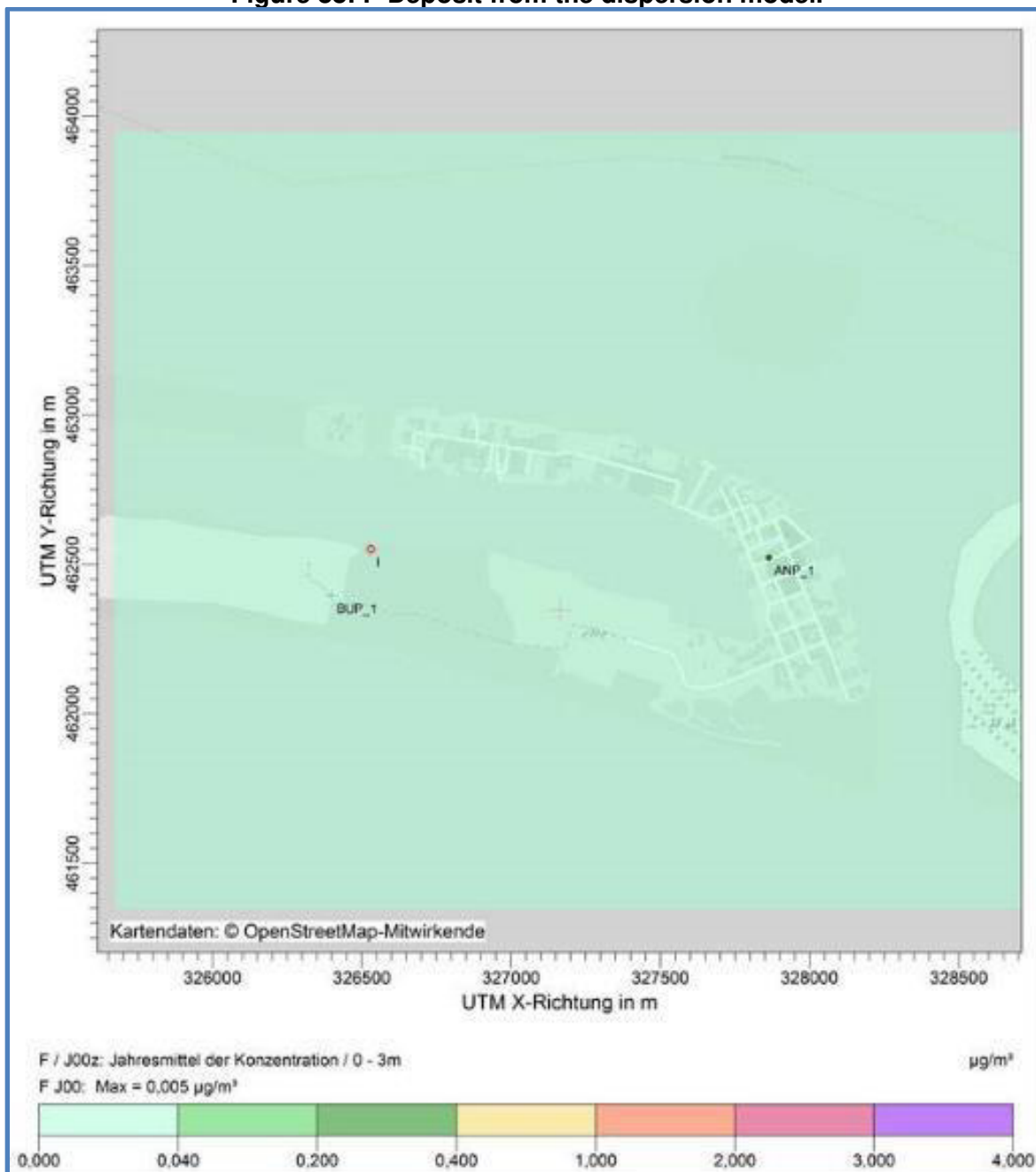


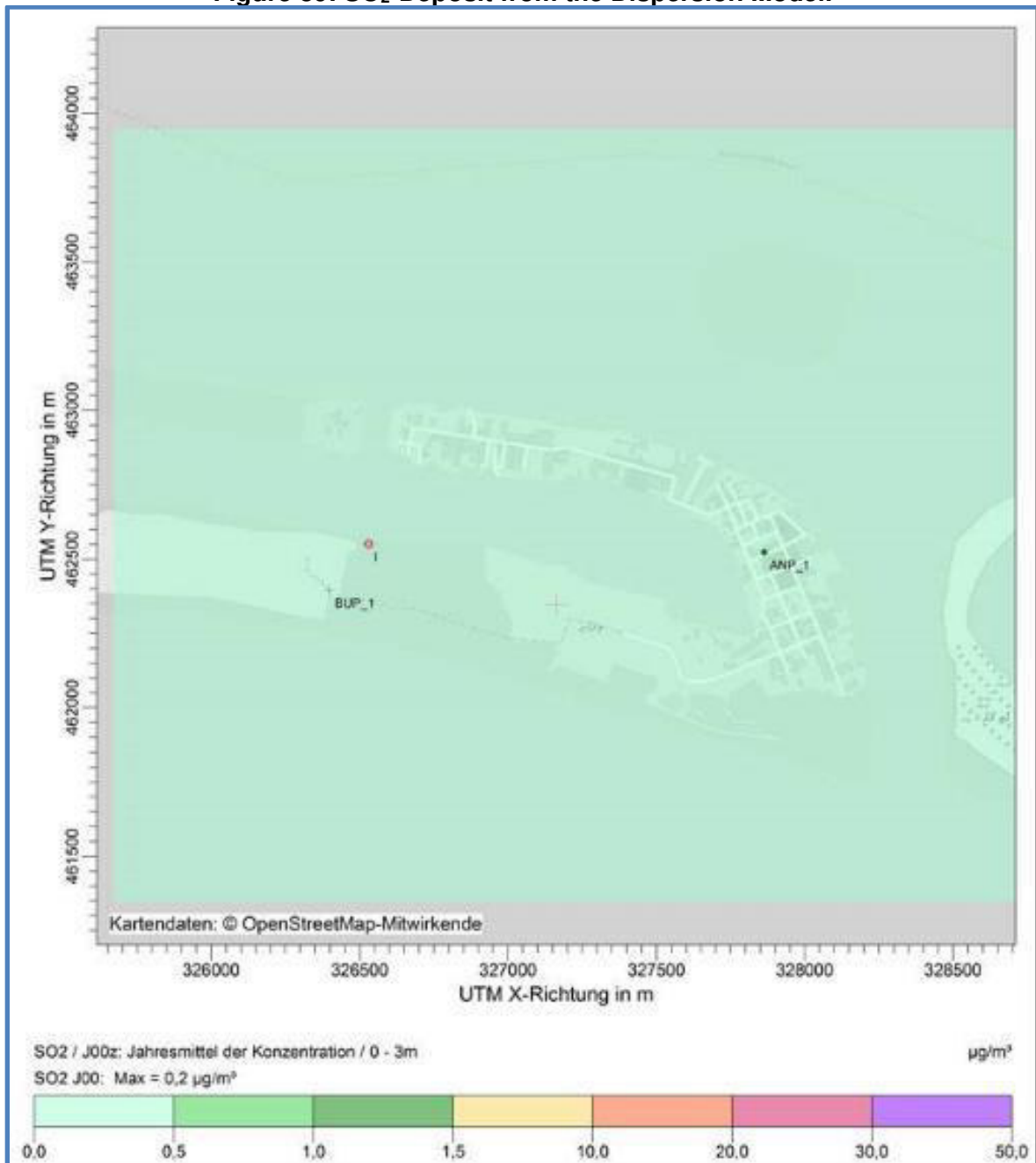
Figure 89: SO<sub>2</sub>-Deposit from the Dispersion Model.

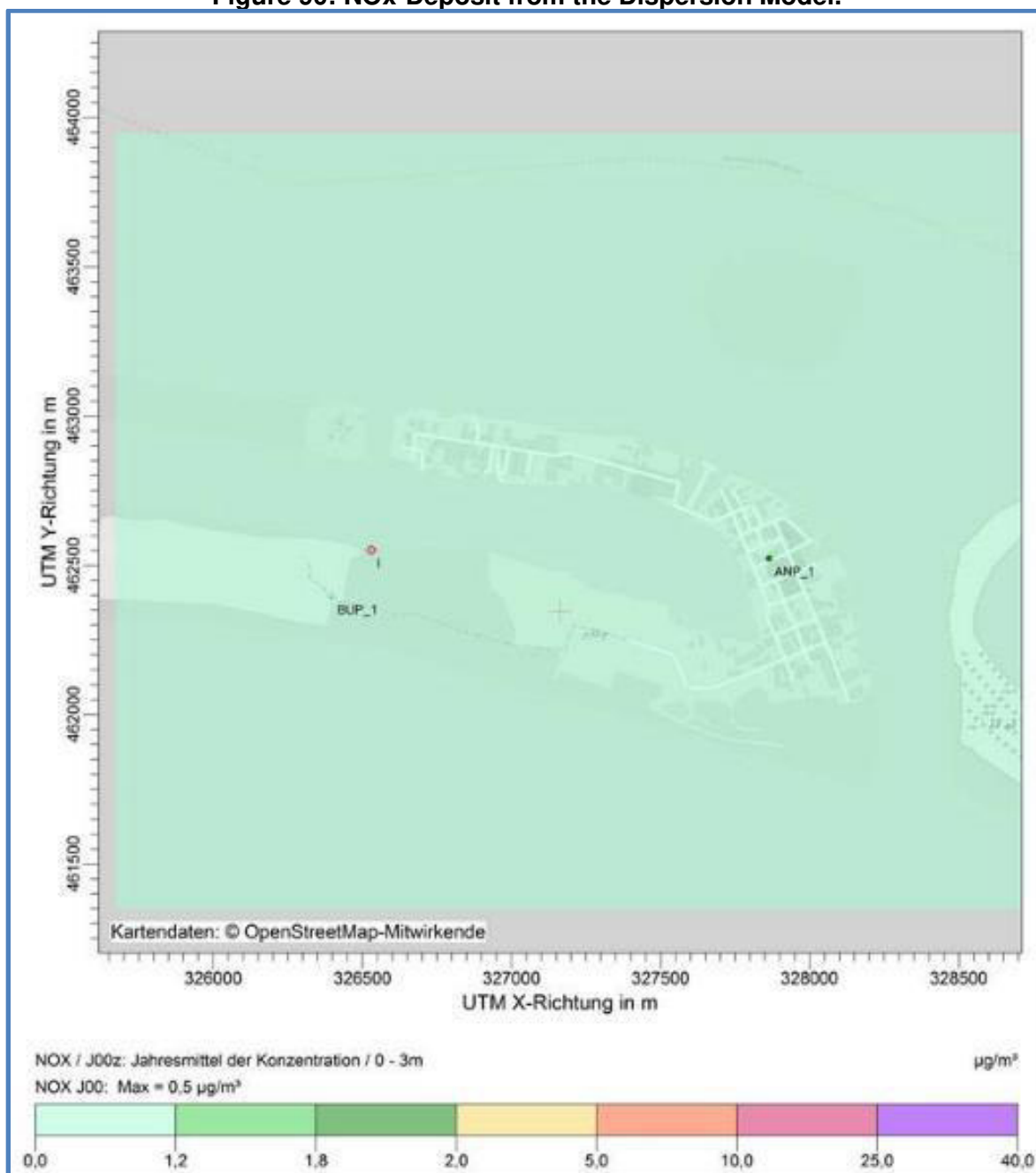
Figure 90: NO<sub>x</sub>-Deposit from the Dispersion Model.

Figure 91: Pb-Deposit from the dispersion model.

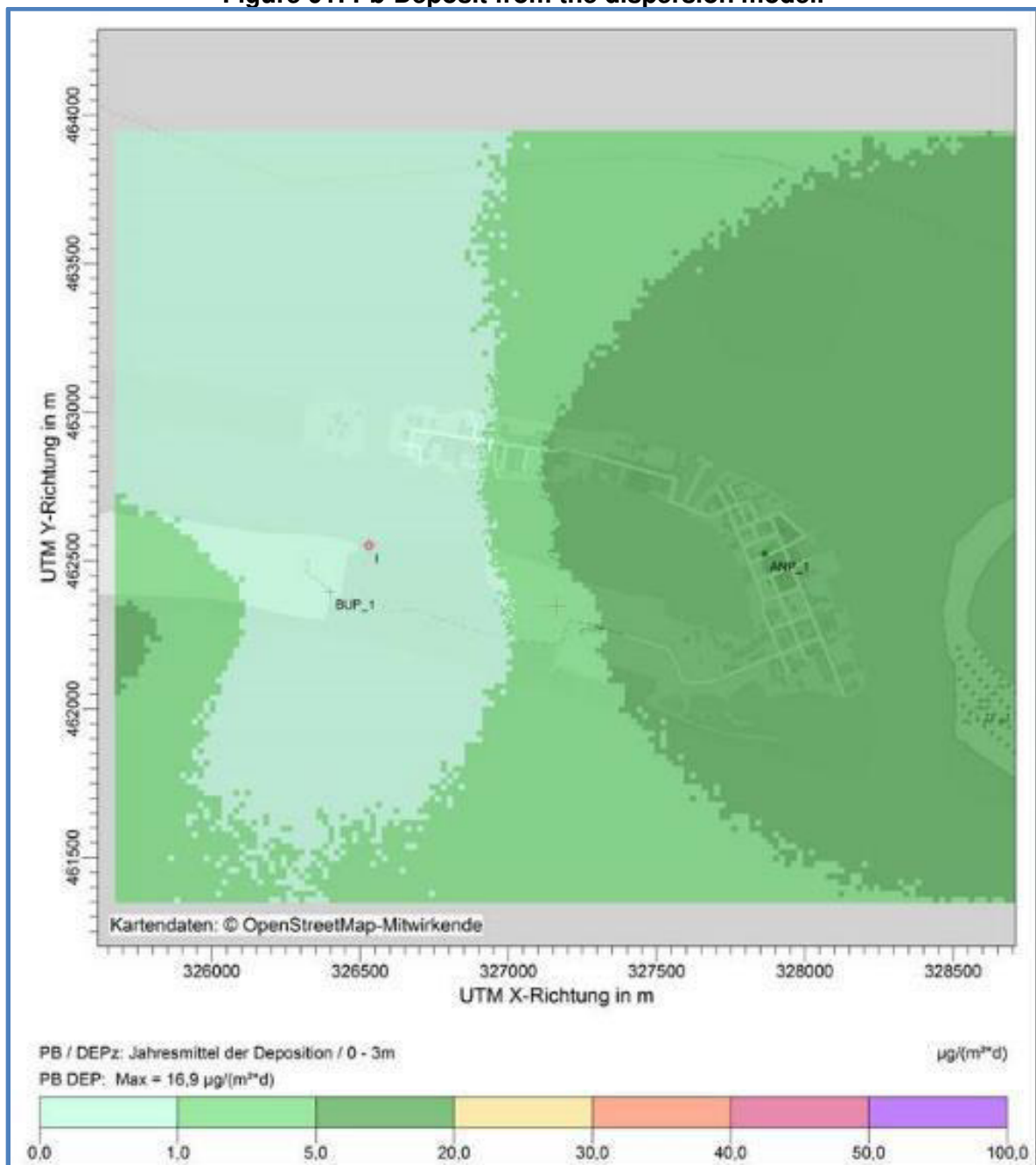


Figure 92: Ni-Deposit from the Dispersion Model.

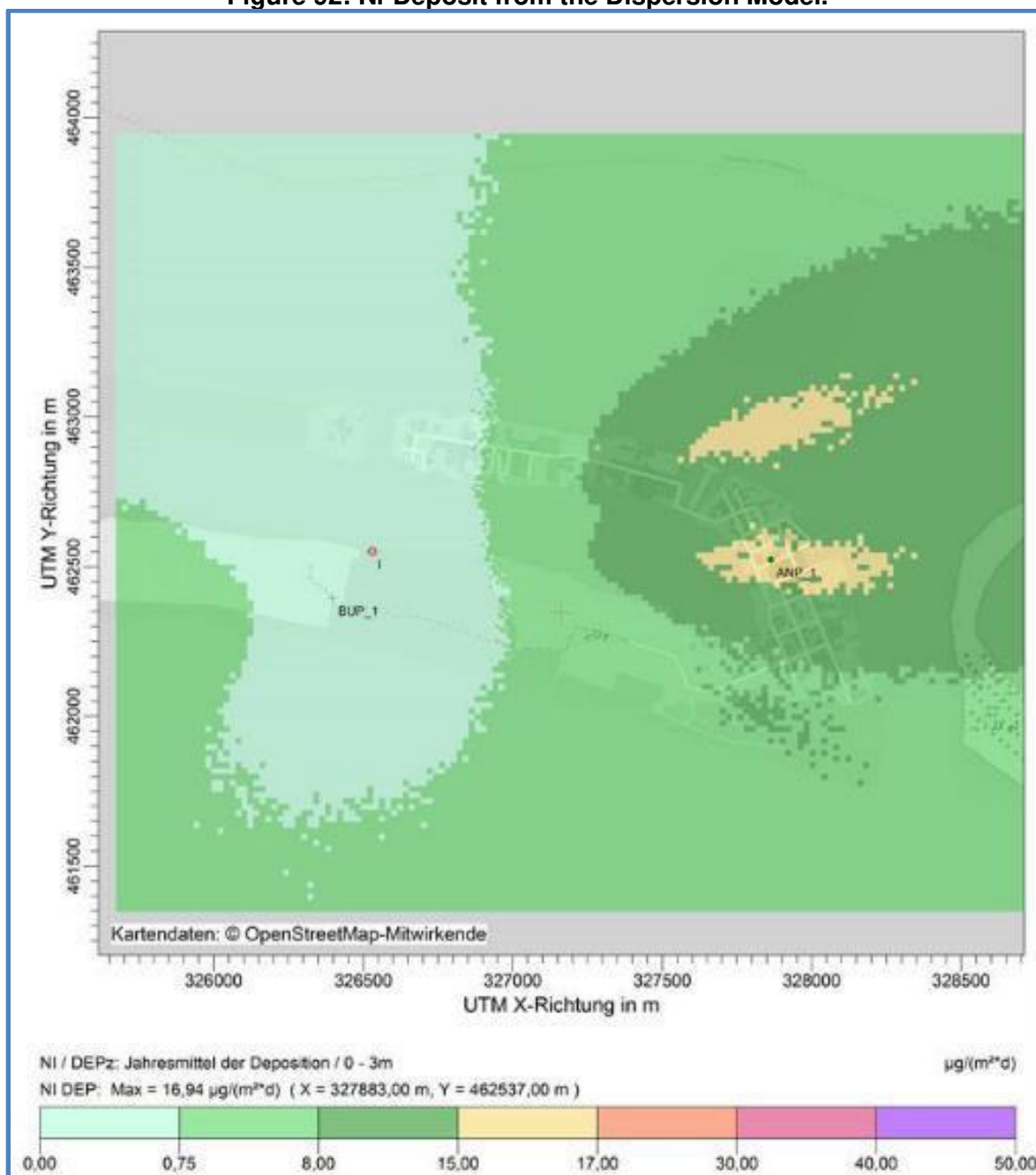


Figure 93: TI-Deposit from the Dispersion Model

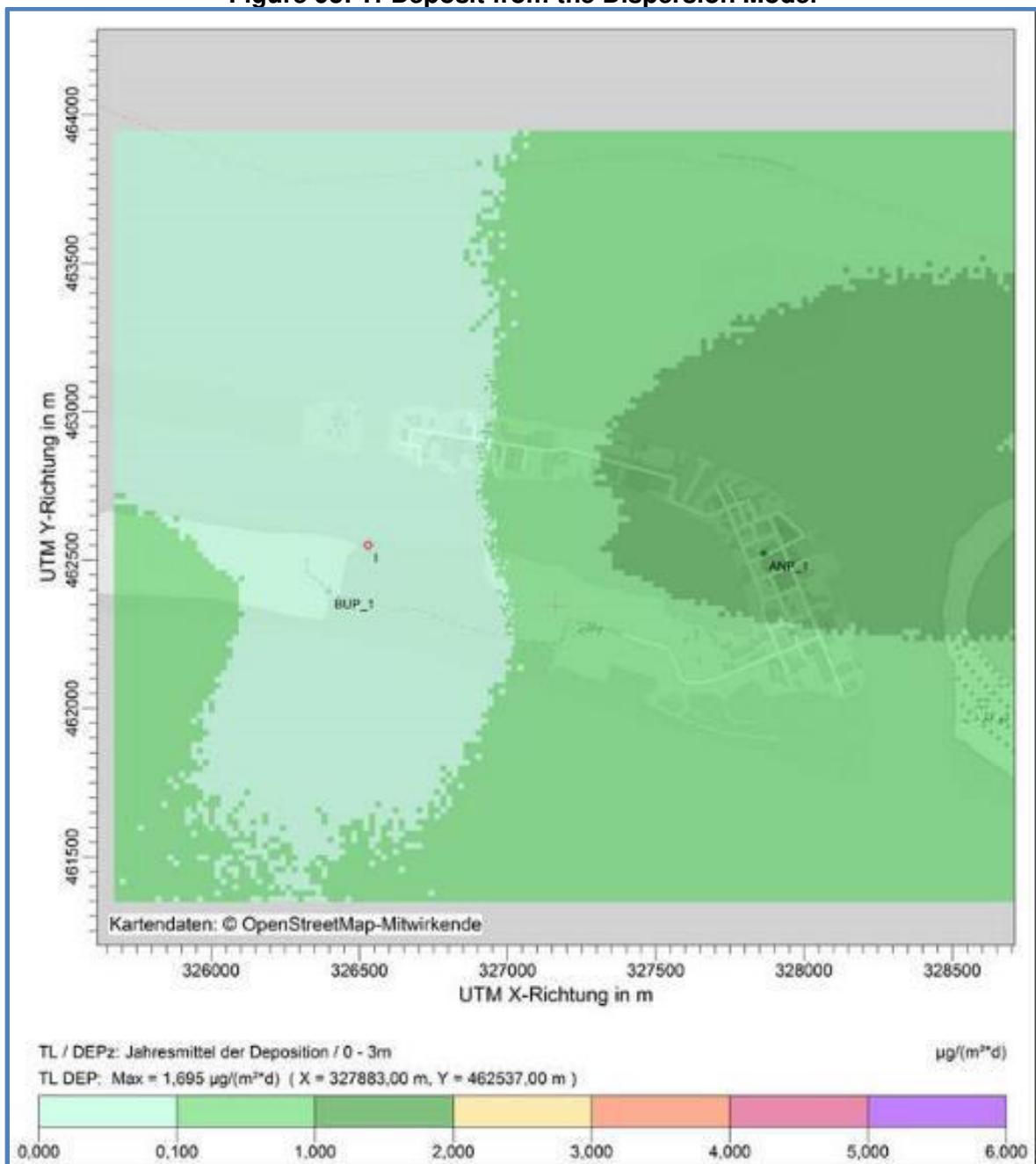


Figure 94: Cd-Deposit from the Dispersion Model.

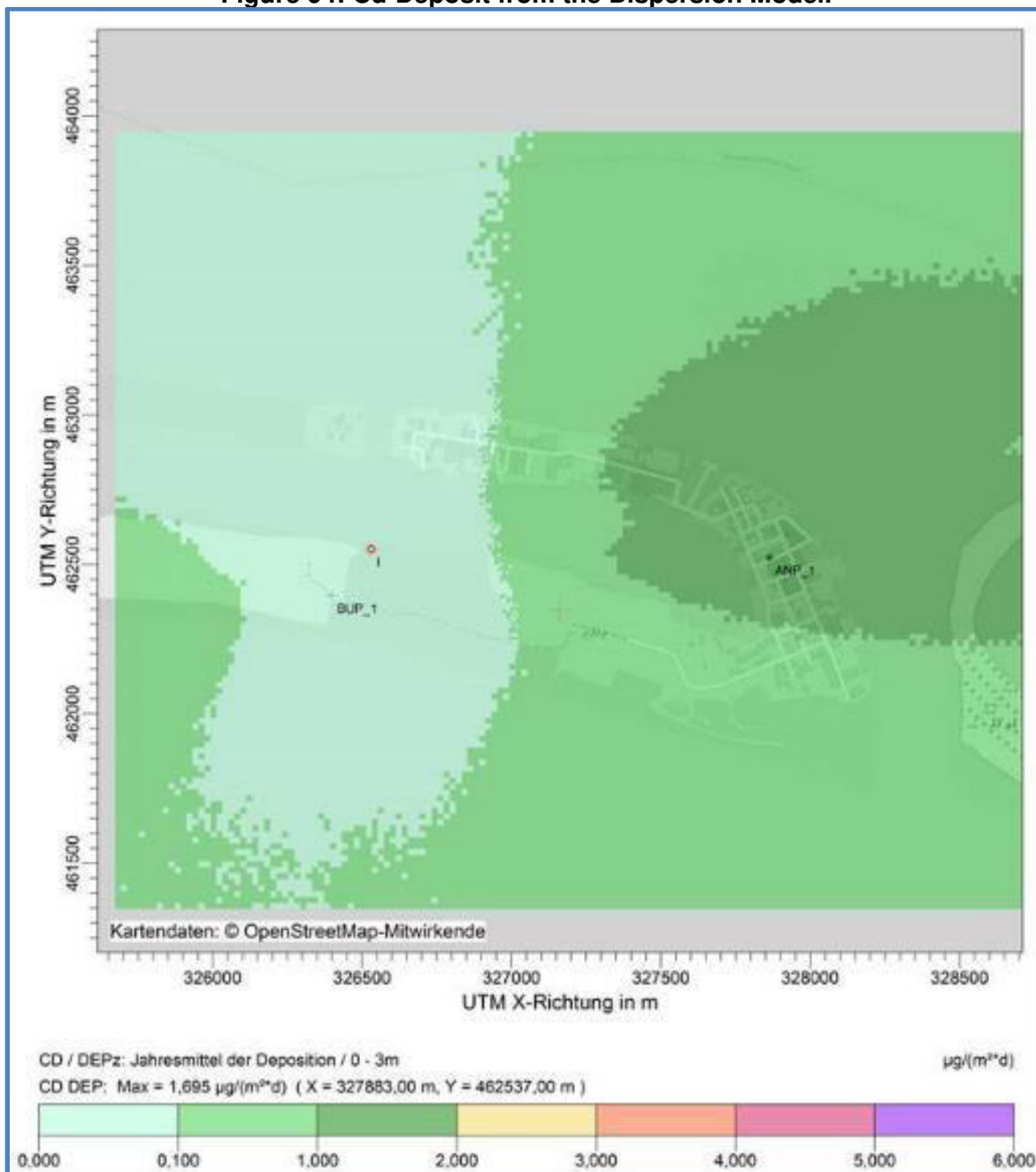
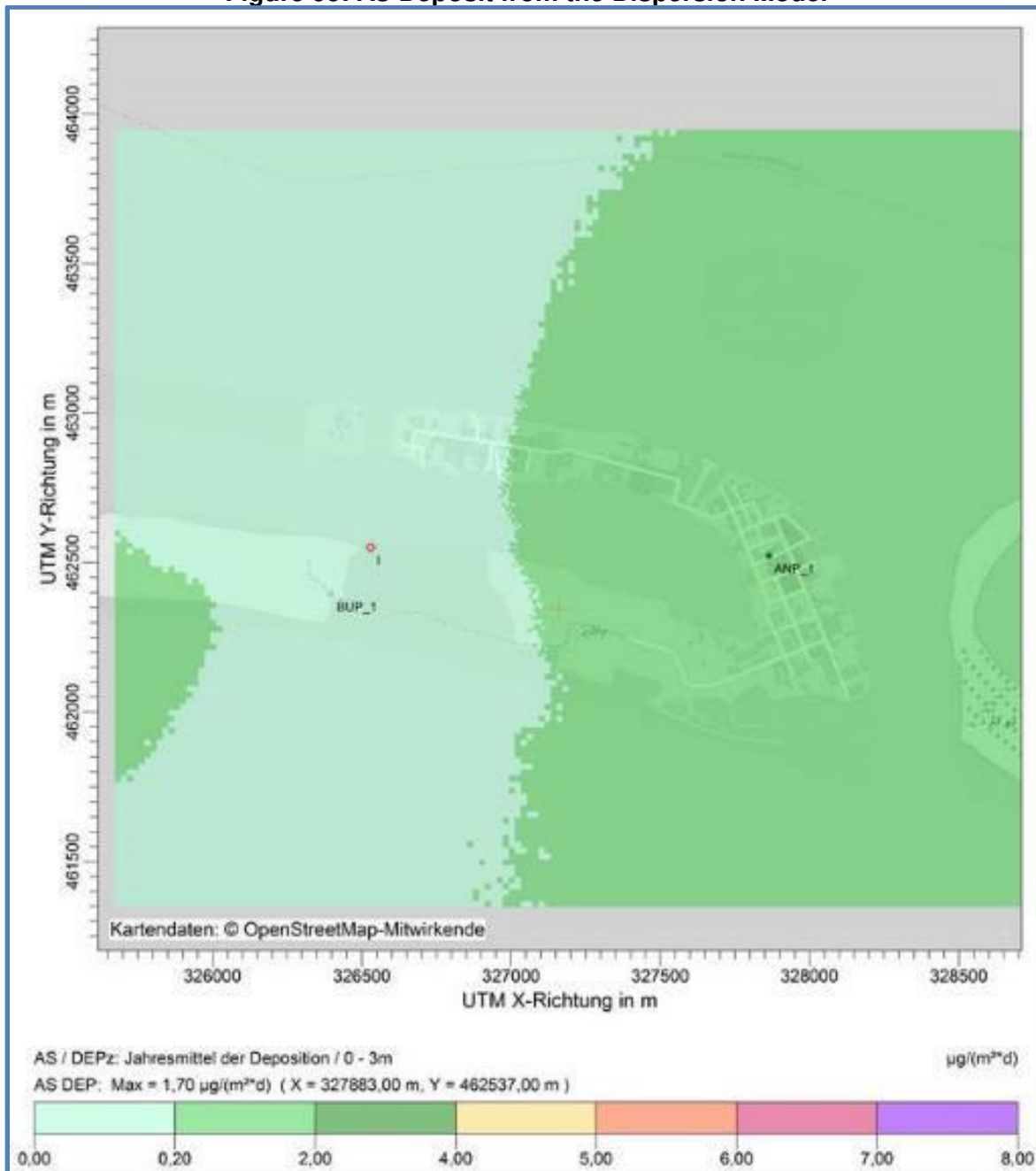


Figure 95: As-Deposit from the Dispersion Model



449. The overall air quality of the project site is expected to improve with time. More significantly when the existing dumpsite is closed. Therefore, a long term and positive significant impact is expected with the operation of this project.

450. **Conclusion.** The ambient air quality status of Maldives had been unknown due to the lack of air quality monitoring data. The air quality is generally considered good as the sea breezes flush the air masses over the small the islands. However, rapid urbanization and economic growth in the recent years has shown noticeable changes in the air quality, particularly in the Malé region. Thilafushi Island is being used to dump huge volume of wastes from the neighboring inhabited



islands (Malé, Villingili and Hulhumalé) and nearby resort islands. Open burning of mixed wastes is being practiced at the island to reduce the volume of the waste. The smoke generated from burning increases the air pollutant load in the local air shed and also affects the air quality of the island.

451. The air quality at the Thilafushi Island is expected to be polluted i.e. the values for the pollutants such as PM<sub>2.5</sub>, PM<sub>10</sub>, SO<sub>2</sub> and NO<sub>x</sub> are expected to be higher in the region downwind of Thilafushi as the smoke plume generated from the open burning of waste frequently passes through this region. The numbers of stations and their locations was selected to collect ambient air quality data that is representative of the baseline air quality of the Thilafushi Island and its surrounding areas.

452. Air quality monitoring for baseline was conducted at four locations. One station was selected in the downwind direction of the plume of smoke from the WTE stack while another station was placed at the crosswind direction of the plume. One station was selected in the crosswind direction of the smoke plume from the existing dump site at Thilafushi. Additional station was selected at Vilingili as a control site. See Figure 37.

453. The ambient air quality results obtained from the monitoring at Villingili undertaken indicate that all parameters were within the WHO guidelines for ambient air quality at station AQ-4 (Villingili Island). The stations at AQ-1 AQ-2 and AQ-3 had all parameters that were beyond the WHO guidelines for ambient air quality. The monitoring results showed that the air quality of Thilafushi which are on downwind wind direction of the existing waste dump site is degraded with the smoke from the dumpsite.

454. In order to estimate exposures to airborne pollutants from the incineration and emergency electricity generation, air pollutant dispersion modelling was carried out. Modelling was done for the pollutants: total dust including fine dust, fluoride and its compound specified as hydrogen fluoride, ammonia, sulfur (sulfur dioxide and sulfur trioxide), specified as sulfur dioxide, nitrogen oxide (nitrogen monoxide and nitrogen dioxide) specified as nitrogen dioxide and mercury and its compound specified as mercury from the waste to energy plant.

455. The dispersion modelling for the pollutants was carried out using the dispersion model AUSTAL2000. The computer program AUSTAL2000 is a reference implementation developed on behalf of the German Federal Environmental Agency. AUSTAL2000 is a steady-state dispersion model that is designed for long-term sources and continuous buoyant plumes. Given that poor meteorological data coverage near the proposed project site, the dispersion model AUSTAL2000 was preferred to a popular dispersion model AERMOD, which requires high quality meteorological data to run the AERMOD.

456. The proposed site for the establishment of the WTE was reclaimed in 2018. The entire Island and the project location are mainly on the main level over MSL and do not present any substantial elevation.

457. The stack emission dispersion modelling showed, except for mercury as well as heavy metals and their components (referred to thallium and arsenic/cadmium and lead/nickel), maximum mass concentrations was achieved by the flue gas cleaning and will be mass concentration of the emission from the stack. Hence emission characteristics was not required as the emissions of the air pollutants do not exceed the minor mass flows. For mercury as well as other heavy metals and their components the values were over the minor flows, therefore dispersion modelling was carried out for these substances.

458. Dispersion modelling showed that the level of lead, thallium, cadmium, arsenic, would be below the ambient air quality value and for mercury, level in the ambient air quality would be reached but not exceeded. It is not expected that heavy metal group occur in the exhaust gas, so that the exceeding of the ambient air quality value for nickel is not expected. The desired mass concentrations by means of flue gas cleaning are below the limit values for ammonia and a negative impact on the environment is therefore not expected. Similar is with hydrogen chloride, total carbon, carbon monoxide, dioxins and furans as desired mass concentrations by means of flue gas cleaning would achieve below the emission value limits.

459. Based on the predicted concentrations and the post project concentrations of concerned pollutants, it can be inferred that the ambient air quality of the area is unlikely to be affected significantly due to proposed project. The overall air quality of the project site is expected to increase with time. More significantly when the existing dumpsite is closed. Therefore, a long term, positive, and significant impact is expected with the operation of this project.

460. **AERMOD.** AERMOD validation modeling was conducted in comparison with the Austal2000 German Lagrangian model. In said report, it was highly acknowledged that AERMOD is a "Stronger model" compared to Austal2000 in complex and urban terrain. It was also noted that Austal2000 was used as an alternative only because of the complexity of the meteorological data requirement of AERMOD. For the AERMOD validation run, the meteorological (metdata) provides a strong advantage because it accounts land use data, surface and upper air and its influence mechanical and convective mixing among other Planetary Boundary Layer (PBL) Parameters included met data set.

461. AERMOD meteorological data utilize surface characteristics in the form of albedo, surface roughness and Bowen ratio, plus standard meteorological observations such as wind speed, wind direction, temperature, and cloud cover. Using the AERMOD metdata processor AERMET, it calculates the PBL parameters such as: friction velocity, Monin-Obukhov length, convective velocity scale, temperature scale, mixing height, and surface heat flux. These parameters are then passed to the Interface within AERMOD where similarity expressions in conjunction with measurements are used to calculate vertical profiles of wind speed, lateral and vertical turbulent fluctuations, potential temperature gradient, and potential temperature. The AERMOD processes the MM5 formatted data to generate \*.SFC and \*.PFL met data files. See snapshot of the generated \*.SFC met data file and \*.PFL met data file. Figure below also shows the AERMOD treatment of boundaries parameters.

462. In the same way as the Austal2000 model, AERMOD validation run has considered the effects of building downwash. Waste to Energy (WTE) dimensions: Approx. Length x width x height [m]: 100 x 70 x 30. Surrounding building location have been considered according to land use plan, topographical survey and Google Earth maps. The height of the buildings has been considered to maximum 10 m. This is another strong feature in AERMOD that the aerodynamic turbulence induced by nearby buildings cause a pollutant emitted from an elevated source to be mixed rapidly toward the ground (downwash), resulting in higher ground-level concentrations.

463. Terrain effects, such as elevations, were also incorporated which have impact on the air dispersion, deposition modeling results and potential risk to human health and the environment. Terrain elevation is the elevation relative to the facility base elevation. Complex Terrain are those elevations defined as anywhere within 50 km from the stack, are above the top of the stack being evaluated in the air modelling analysis. Terrain consideration was determined using SRTM3 terrain data processed by AERMAP terrain processor and has noted that highest elevations in the project area is at 7 meters only above sea level. Nevertheless, this AERMOD validated

executed terrain situations using SRTM3 terrain data processed by AERMAP terrain processor where model considers terrain height exceeds stack base elevation, model receptors are also assumed on elevated terrain. Terrain elevations for receptors in the receptor Pathway are also considered.

464. Output of model run includes: 1-hour, 24-hour, and 1 year averaging time plot files, isopleths diagrams, and table of worst-case scenarios. Meteorological data used is based on TIER 4 meteorological data, NCAR MM5 (5th-generation Mesoscale Model) prognostic meteorological model was the basis for meteorological background of the areas. Prognostic MM5 meteorological model are specified location and site domain. Once the MM5 preprocessing has been completed, the MM5 output file is converted into a format recognized by the AERMET model (meteorological preprocessor for the AERMOD model). The final output is generated by creating a pseudo met station at the specified site location.

465. **Area Sensitive Receptors (ASRs).** Area Sensitive Receptors (ASRs) include, but are not limited to residential areas, hospitals, schools, daycare facilities, elderly housing and convalescent facilities. These are areas where the occupants are more susceptible to the adverse effects of exposure to air pollutants. Extra monitoring and abatement efforts must be taken when dealing with contaminants and pollutants in close proximity to areas recognized as ASRs. For the WTE project and for the purpose of assessing potential impacts, Thilafushi islands' industrial areas are considered as ASRs as there are identified facilities with workers quarters. ASRs are located in the following area and details are provided in the main text of this report: (i) ASR1-ENE; (ii) ASR2-SSE; (iii) ASR3-NNE; (iv) ASR4-SSW; and (v) ASR5-NNW 474 to 1273 meters upwind and downwind directions from the center of the domain at UTM coordinates easting 326540 and northing 462472. This AERMOD Report includes results of the dispersion model showing the highest predicted ground level concentrations (GLC) in the ASRs.

466. The results and outputs of the models are compared with TA Luft Standards as specified in the Austal2000 Report and applicable United States Environmental Protection Agency (USEPA) standards and World Health Organization Air Quality Guidelines.

467. **Total Dust (TD).** Predicted short term (1 hour) for controlled<sup>41</sup> total dust (TD) maximum ground level concentrations is 7.60 ug/m<sup>3</sup> located 280 meters ENE from the center of the domain. The 24-hour controlled total dust (TD) maximum ground level concentrations is 3.188 ug/m<sup>3</sup> located 608 meters ENE from the center of the domain. Simulated concentrations for maximum ground level concentration for 1-hour total dust (TD) are generally very low. There is no available the Ambient Air Quality Standards for total dust in the Austal2000 Report. For the total dust (TD) deposition, AERMOD results shows 0.00754 g/m<sup>2</sup> for 1-hour, 0.038505 g/m<sup>2</sup> for 24 hr, and 0.43394 g/m<sup>2</sup> for 1 year deposition. Deposition simulations are all below the TA Luft precipitation limit of 0.35 g/m<sup>2</sup>-d. There are no applicable USEPA standards and WHO Air Quality Guideline Values. Reference center of the domain is the location of the Boiler Stack-1 at Universal Transverse Mercator (UTM) coordinates Easting 326540 and Northing 462472.

468. **Particulate Matter 10 (PM-10).** Predicted short term (1 hour) for controlled particulate matter 10 (PM-10) maximum ground level concentrations is 0.102 ug/m<sup>3</sup> located 100 meters E from the center of the domain. The 24-hour controlled PM-10 maximum ground level concentrations is 0.02844 ug/m<sup>3</sup> located 100 meters E from the center of the domain. Simulated

---

<sup>41</sup>Controlled emission parameters refer to post-air pollution control devices. For the WTE, each stack will include baghouse and electrostatic precipitators.

concentration for maximum ground level concentration for 24-hour PM10 is below the 35 ug/m3 TA Luft standards. There is no available Ambient Air Quality Standards for PM-10 in the Austal2000 report. For the PM-10 deposition, AERMOD results shows 0.00037 g/m2 for 1 hour, 0.0007g/m2 for 24 hour and 0.025 g/m2 for 1 year deposition. There is no TA Luft precipitation limit for PM10 in the Austal2000 report. Results are below WHO Air Quality Guideline Values. There are no USEPA standards. Reference center of the domain is the location of the Boiler Stack-1 at UTM coordinates Easting 326540 and Northing 462472.

469. **Sulfur Dioxide (SO<sub>2</sub>)**. Predicted short term (1 hour) for controlled sulfur dioxide (SO<sub>2</sub>) maximum ground level concentrations is 10.34 ug/m3 located 100 meters E from the center of the domain. The 24-hour controlled SO<sub>2</sub> maximum ground level concentrations is 2.85 ug/m3 located 100 meters E from the center of the domain. For 1-year averaging time, result of maximum concentration is 0.25302 ug/m3. All simulated concentration for maximum ground level concentration for 1 hour, 24 hour and 1-year SO<sub>2</sub> are all below the TA Luft standards of 350 ug/m3 for 1 hour, 125 ug/m3 for 24 hr and 50 ug/m3 for 1 year respectively. Results are below USEPA standards and WHO Air Quality Guideline Values. Reference center of the domain is the location of the Boiler Stack-1 at UTM coordinates Easting 326540 and Northing 462472.

470. **Nitrogen Oxides (NO<sub>x</sub>)** Predicted short term (1 hour) for controlled NO<sub>2</sub> maximum ground level concentration is 48.91 ug/m3 located 100 meters E from the center of the domain. The 24-hour controlled NO<sub>2</sub> maximum ground level concentrations is 14.16 ug/m3 located 100 meters E from the center of the domain. For 1-year averaging time, results of maximum NO<sub>2</sub> concentration is 2.1 ug/m3. Simulated concentration for maximum NO<sub>2</sub> ground level concentration for 1 year is below the TA Luft standards of 18 ug/m3. Results are below USEPA standards and WHO Air Quality Guideline Values. Reference center of the domain is the location of the Boiler Stack-1 at UTM coordinates Easting 326540 and Northing 462472.

471. **Mercury (Hg)**. Predicted short term (1 hour) for controlled mercury (Hg) maximum ground level concentrations is 0.00643 ug/m3 located 100 meters E from the center of the domain. The 24-hour controlled Hg maximum ground level concentrations is 0.00178 ug/m3 located 100 meters E from the center of the domain. For 1-year averaging time, result of maximum concentration is 0.0057 ug/m3. Simulated concentration for maximum ground level concentration for 1-year Hg is below the TA Luft standards of 0.05 ug/m3. There are no USEPA standards and WHO Air Quality Guideline Values. Reference center of the domain is the location of the Boiler Stack-1 at UTM coordinates Easting 326540 and Northing 462472.

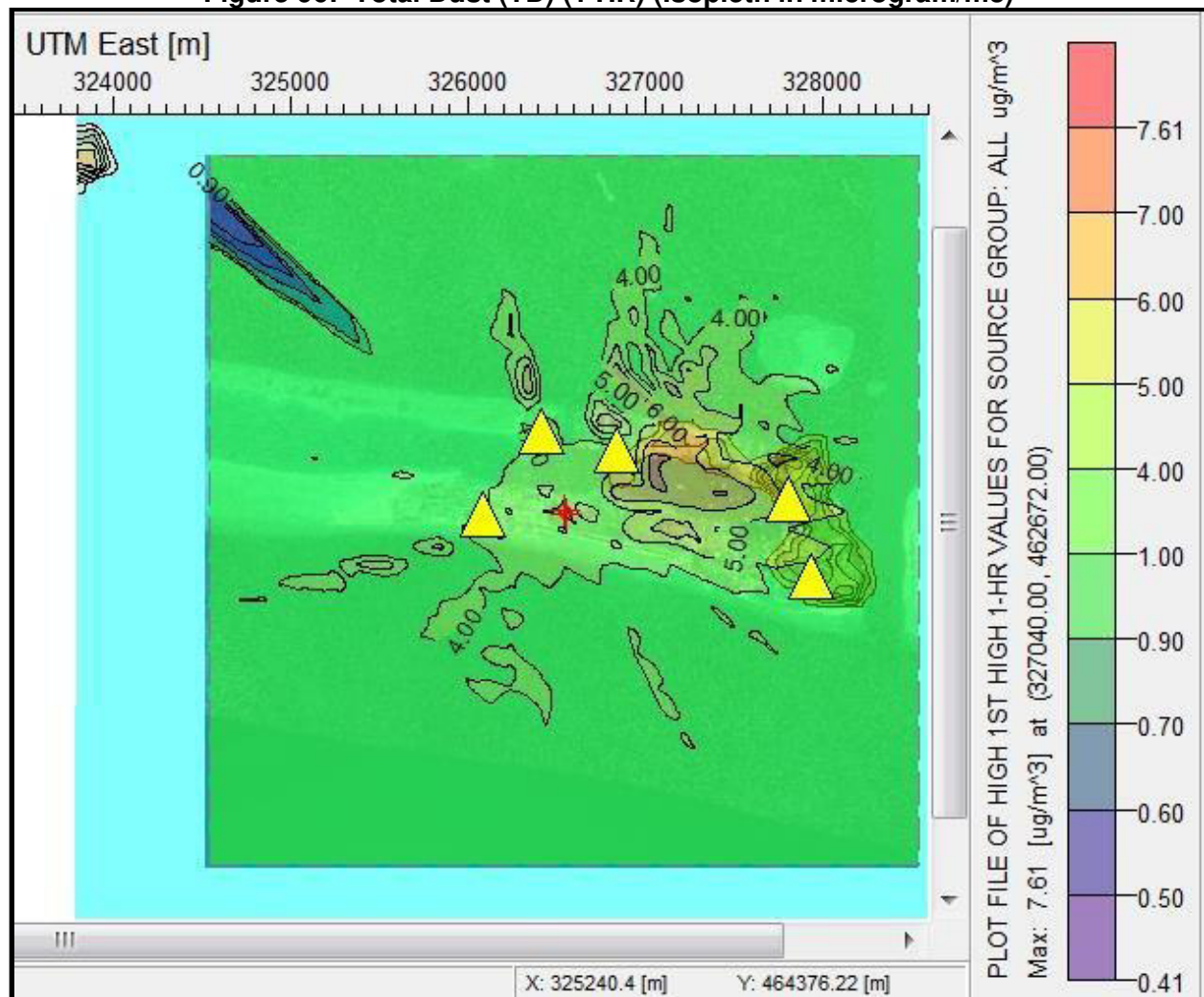
472. **Ammonia (NH<sub>3</sub>)**. Predicted short term (1 hour) for controlled ammonia (NH<sub>3</sub>) maximum ground level concentrations is 2.066 ug/m3 located 100 meters E from the center of the domain. The 24-hour controlled NH<sub>3</sub> maximum ground level concentrations is 0.57123 ug/m3 located 100 meters E from the center of the domain. There are no NH<sub>3</sub>TA Luft standards in the Austal2000 report. There are no USEPA standards and WHO Air Quality Guideline Values. Reference center of the domain is the location of the Boiler Stack-1 at UTM coordinates easting 326540 and northing 462472.

473. **Hydrogen Chloride (HCl)**. Predicted short term (1 hour) for controlled hydrogen chloride (HCl) maximum ground level concentrations is 2.066 ug/m3 located 100 meters E from the center of the domain. The 24-hour controlled NH<sub>3</sub> maximum ground level concentrations is 0.57123 ug/m3 located 100 meters E from the center of the domain. There are no HCl TA Luft standards in the Austal2000 report. There are no USEPA standards and WHO Air Quality Guideline Values. Reference center of the domain is the location of the Boiler Stack-1 at UTM coordinates Easting 326540 and Northing 462472.

474. **Hydrogen Fluoride (HFI).** Predicted short term (1 hour) for controlled hydrogen fluoride (HFI) maximum ground level concentrations is 2.066 ug/m<sup>3</sup> located 100 meters E from the center of the domain. The 24-hour controlled HFI maximum ground level concentrations is 0.57123 ug/m<sup>3</sup> located 100 meters E from the center of the domain. There are no HFI TA Luft standards in the Austal2000 report. There are no USEPA standards and WHO Air Quality Guideline Values. Reference center of the domain is the location of the Boiler Stack-1 at UTM coordinates Easting 326540 and Northing 462472.

475. **Dioxins and Furans (D/F).** Predicted short term (1 hour) for controlled Dioxins and Furans maximum ground level concentrations is 0.0258 ug/m<sup>3</sup> located 100 meters E from the center of the domain. The 24 hour-controlled Dioxins and Furans maximum ground level concentrations is 0.00569 ug/m<sup>3</sup> located 100 meters E from the center of the domain. There are no Dioxins and Furans TA Luft standards in the Austal2000 report. There are no USEPA standards and WHO Air Quality Guideline Values. Reference center of the domain is the location of the Boiler Stack-1 at UTM coordinates Easting 326540 and Northing 462472.

**Figure 96: Total Dust (TD) (1 HR) (Isoleth in microgram/m<sup>3</sup>)**

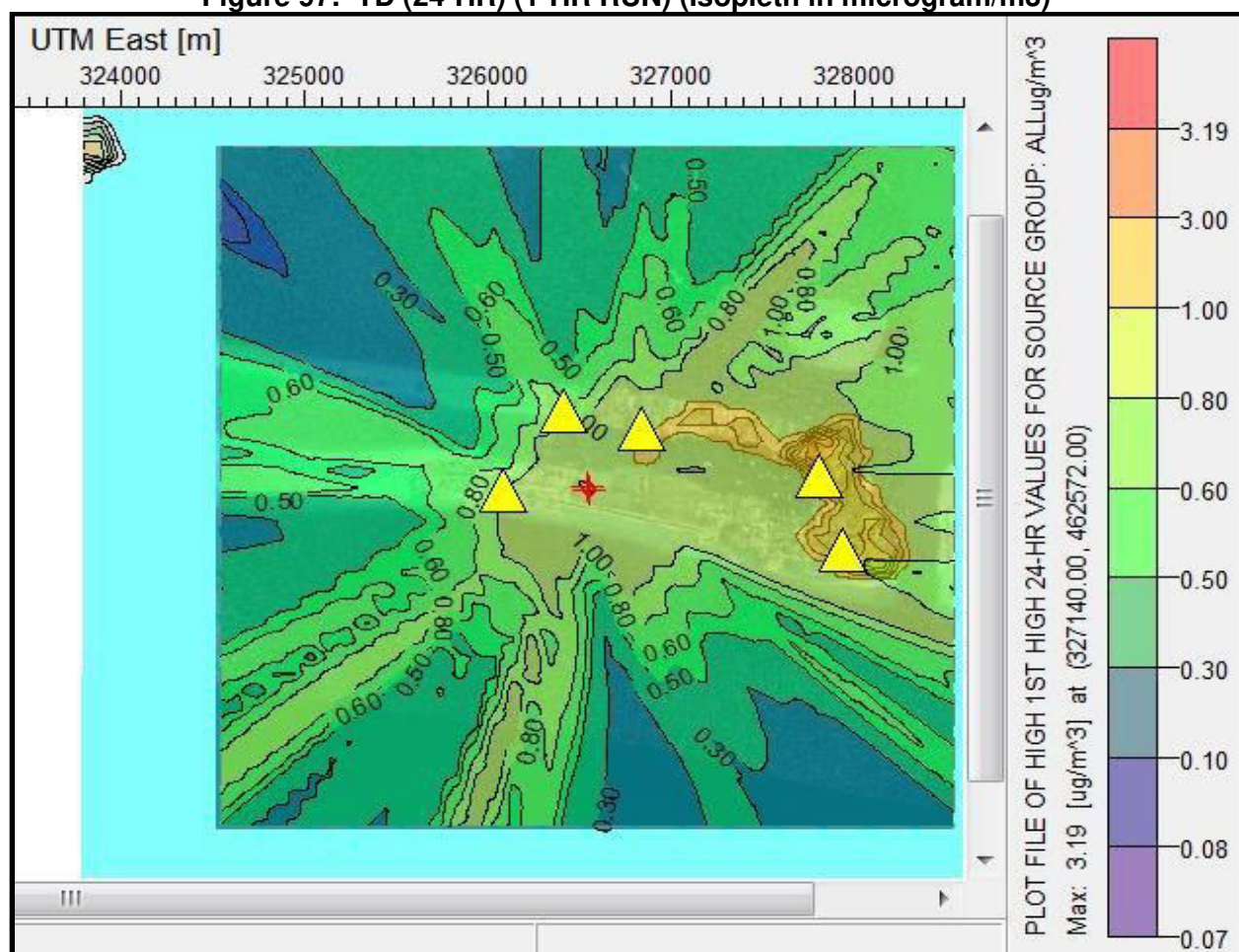


LEGEND:

Yellow Triangles refer to identified Area Sensitive Receptor (ASRs)

	Long	Lat
ASR1	327812	462536
ASR2	327938	462105
ASR3	326839	462822
ASR4	326087	462455
ASR5	326416	462929

Figure 97: TD (24-HR) (1-HR RUN) (Isopleth in microgram/m<sup>3</sup>)



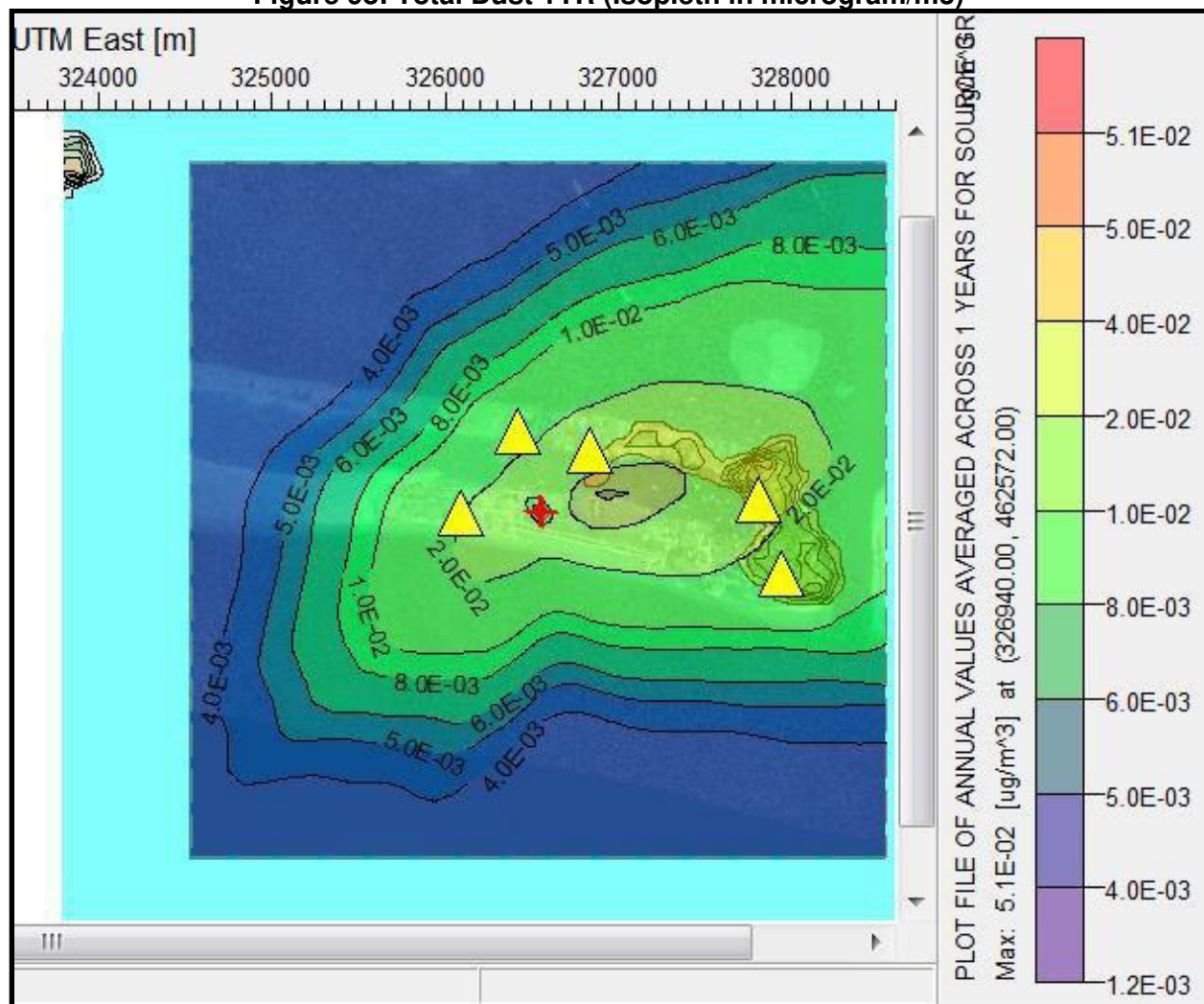
LEGEND:

Yellow Triangles refer to identified Area Sensitive Receptor (ASRs)

	Long	Lat
ASR1	327812	462536
ASR2	327938	462105
ASR3	326839	462822
ASR4	326087	462455

ASR5	326416	462929
------	--------	--------

Figure 98: Total Dust 1YR (Isopleth in microgram/m<sup>3</sup>)

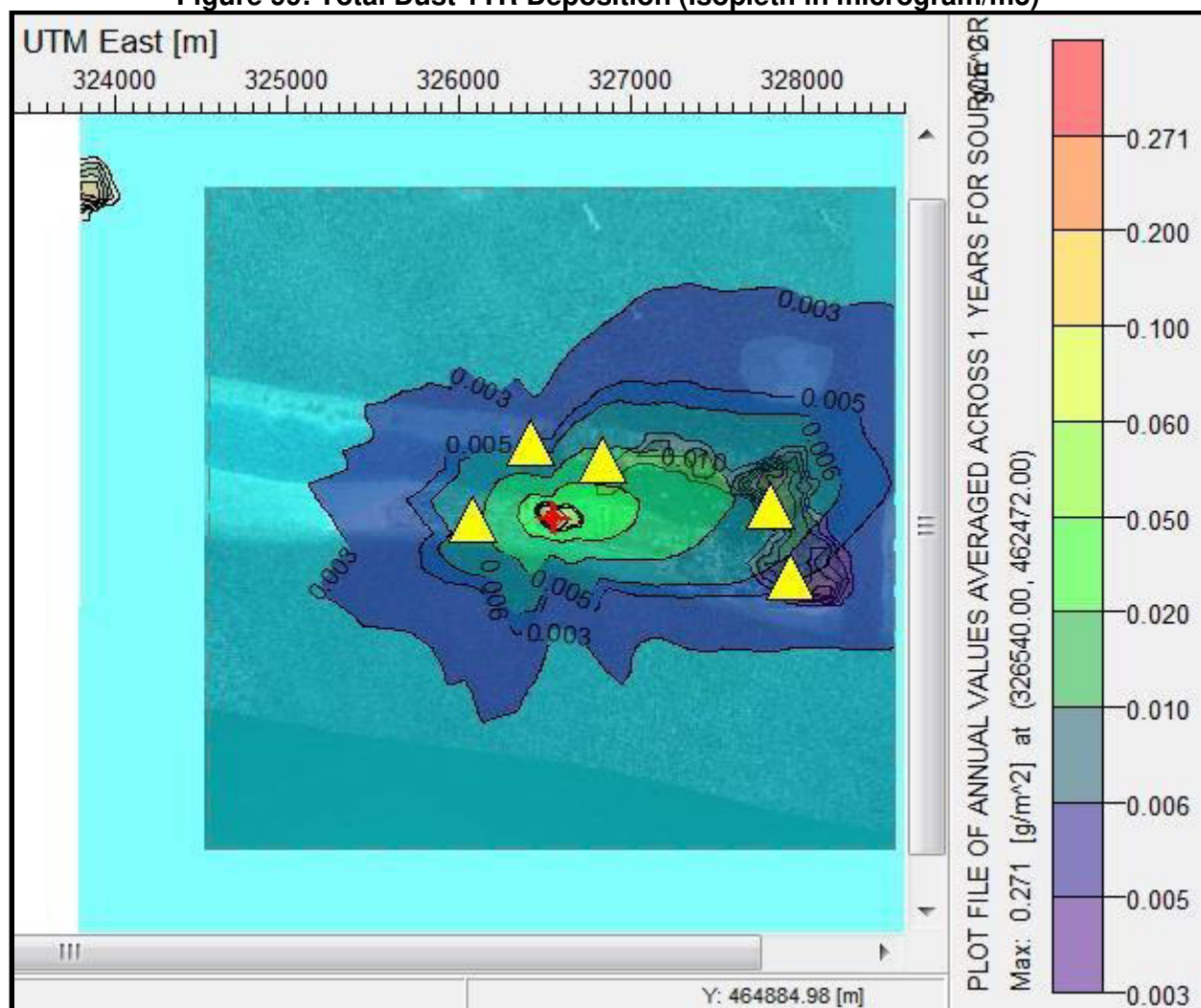


LEGEND:

Yellow Triangles refer to identified Area Sensitive Receptor (ASRs)

	Long	Lat
ASR1	327812	462536
ASR2	327938	462105
ASR3	326839	462822
ASR4	326087	462455
ASR5	326416	462929

Figure 99: Total Dust 1YR Deposition (Isopleth in microgram/m<sup>3</sup>)



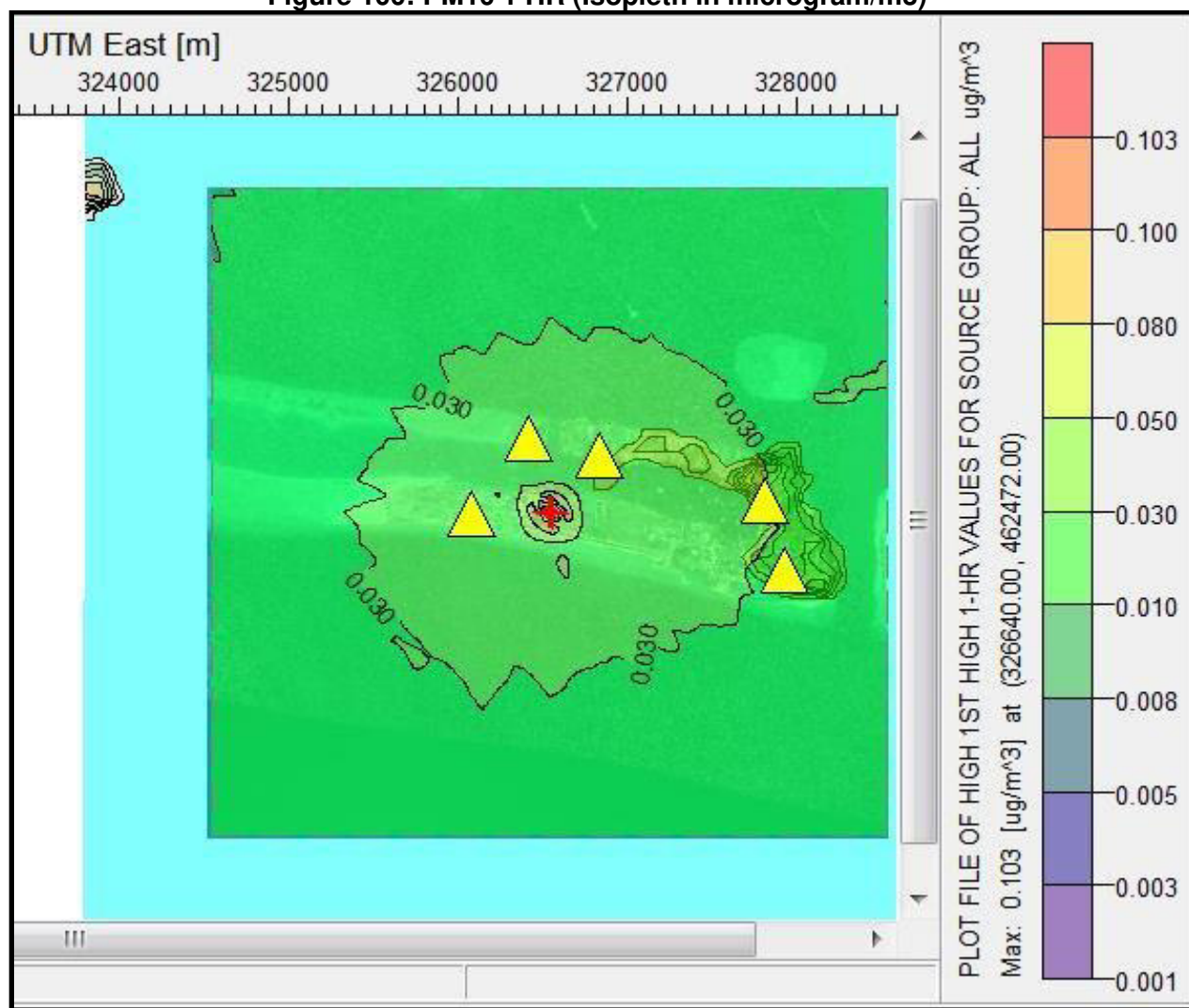
LEGEND:

Yellow Triangles refer to identified Area Sensitive Receptor (ASRs)

	Long	Lat
ASR1	327812	462536
ASR2	327938	462105
ASR3	326839	462822
ASR4	326087	462455
ASR5	326416	462929



Figure 100: PM10 1 HR (Isopleth in microgram/m3)

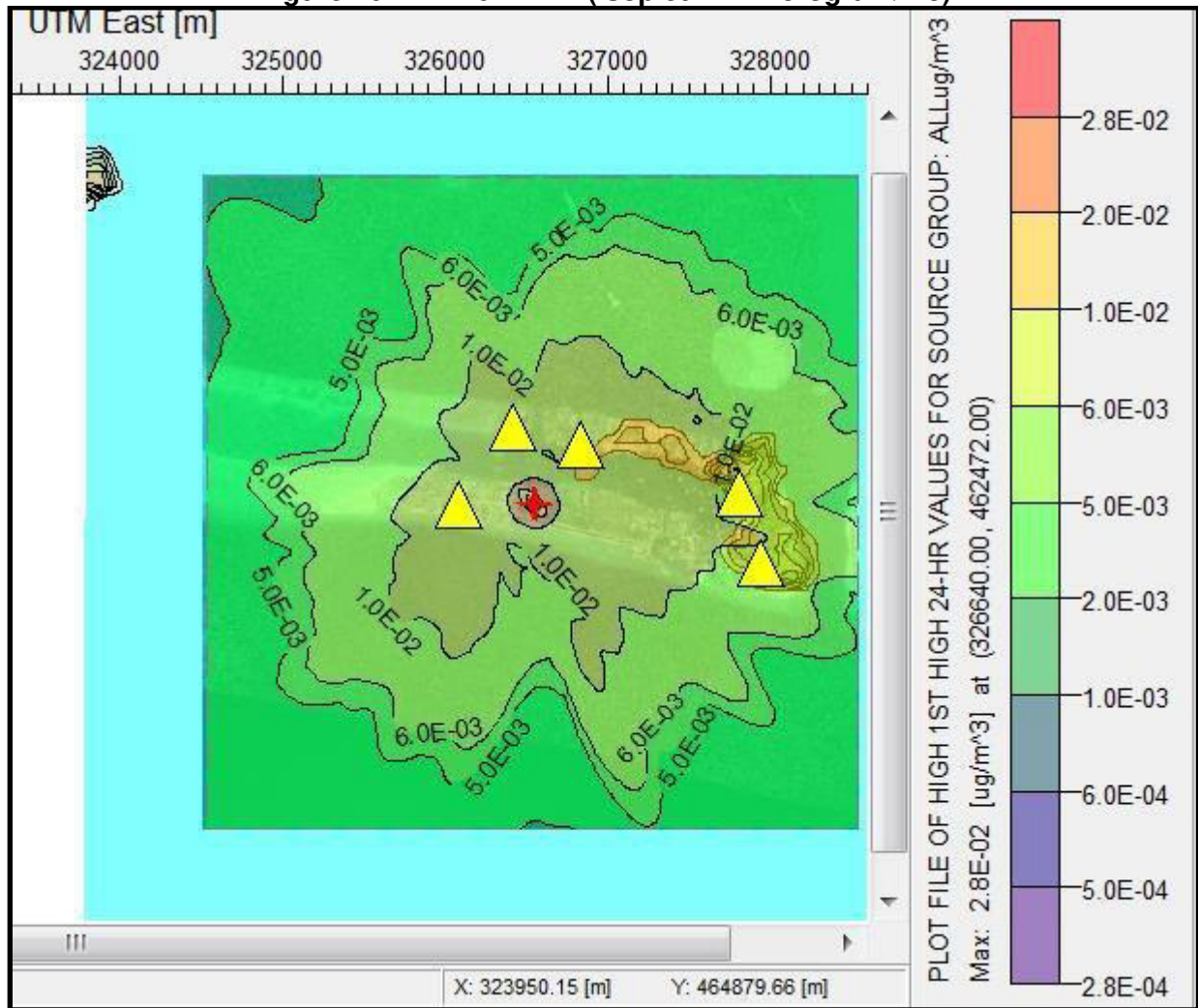


LEGEND:

Yellow Triangles refer to identified Area Sensitive Receptor (ASRs)

	Long	Lat
ASR1	327812	462536
ASR2	327938	462105
ASR3	326839	462822
ASR4	326087	462455
ASR5	326416	462929

Figure 101: PM10 24 HR (Isopleth in microgram/m<sup>3</sup>)

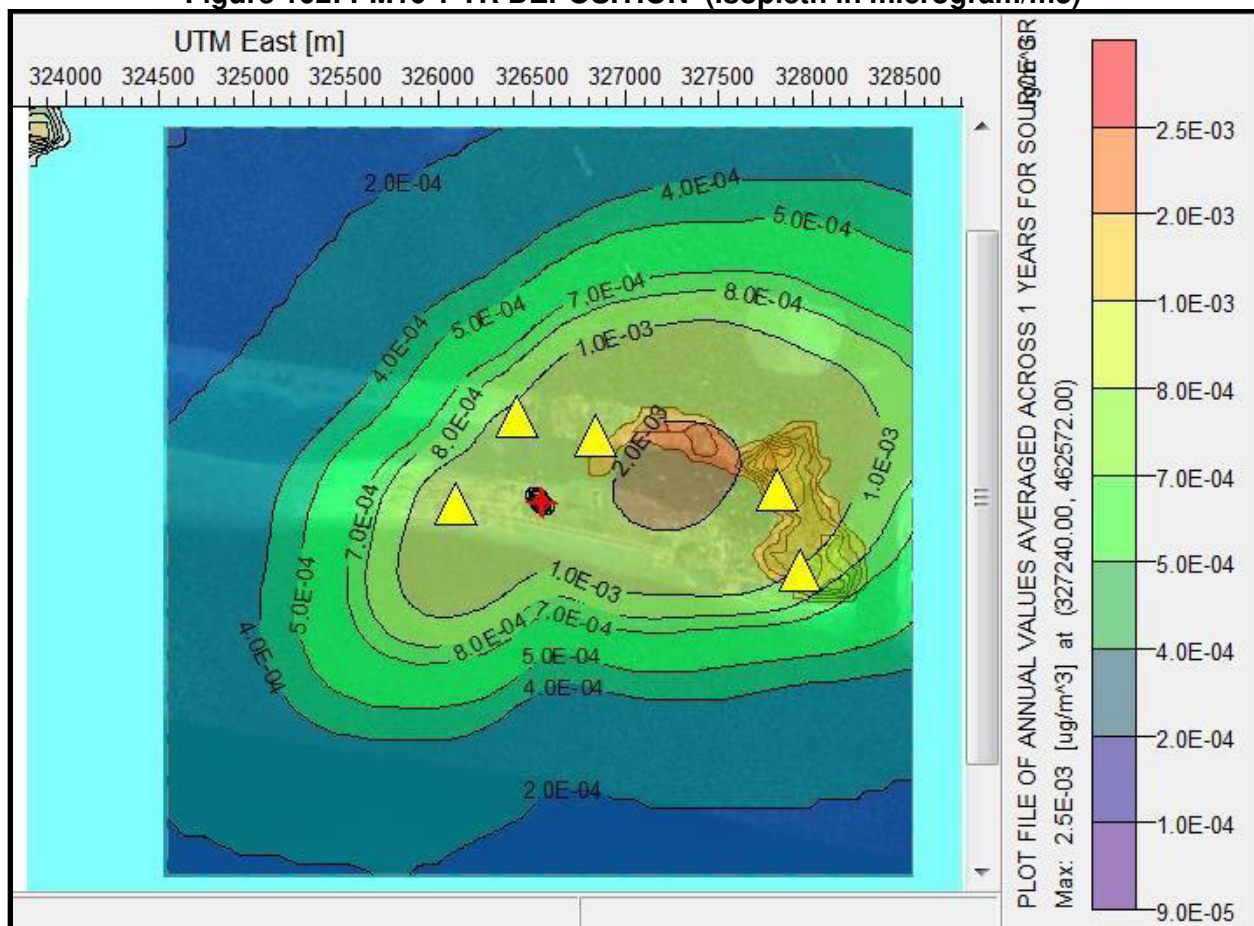


LEGEND:

Yellow Triangles refer to identified Area Sensitive Receptor (ASRs)

	Long	Lat
ASR1	327812	462536
ASR2	327938	462105
ASR3	326839	462822
ASR4	326087	462455
ASR5	326416	462929

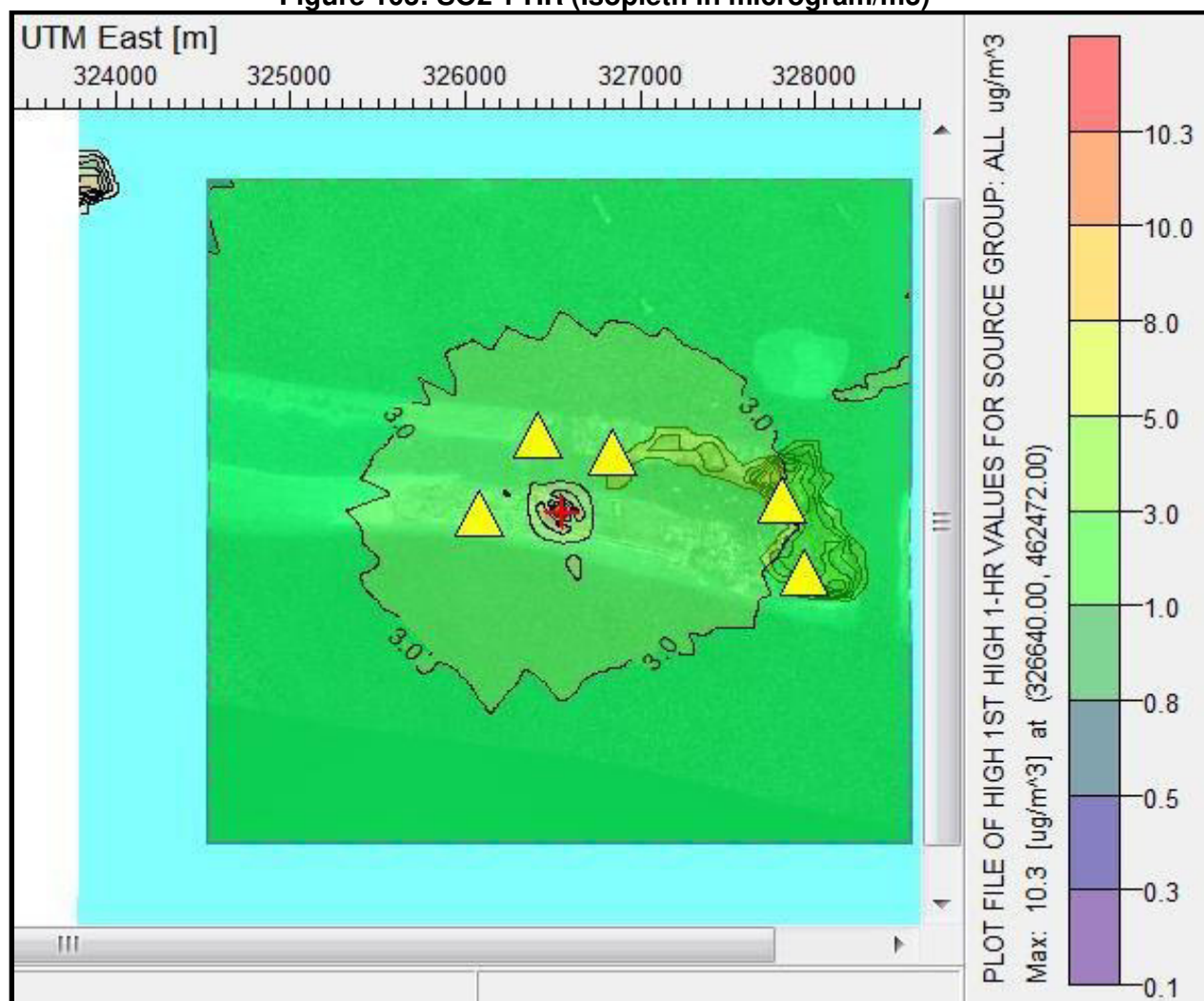
**Figure 102: PM10 1 YR DEPOSITION (Isopleth in microgram/m3)**



LEGEND:

Yellow Triangles refer to identified Area Sensitive Receptor (ASRs)

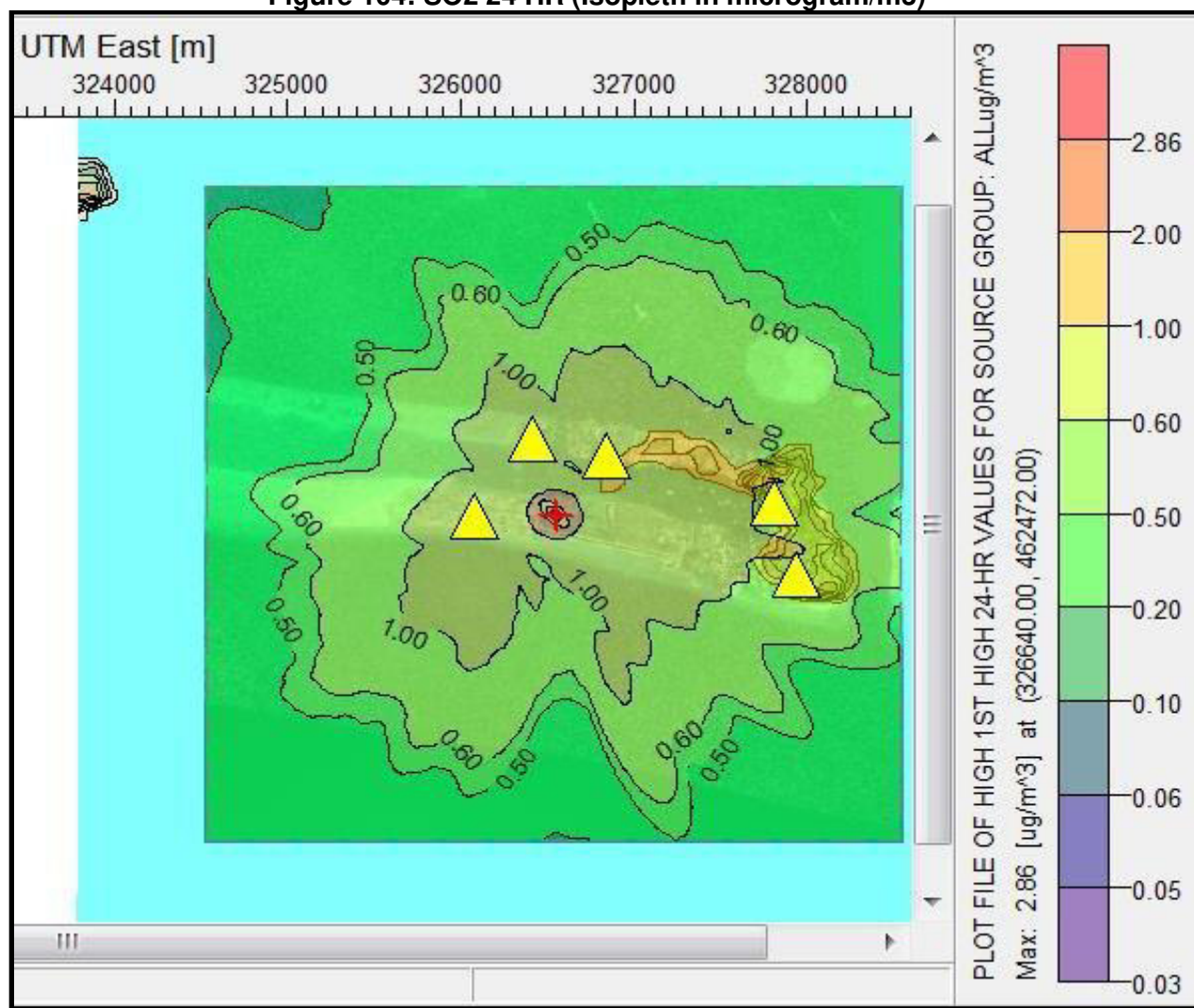
	Long	Lat
ASR1	327812	462536
ASR2	327938	462105
ASR3	326839	462822
ASR4	326087	462455
ASR5	326416	462929

Figure 103: SO<sub>2</sub> 1 HR (Isopleth in microgram/m<sup>3</sup>)

LEGEND:

Yellow Triangles refer to identified Area Sensitive Receptor (ASRs)

	Long	Lat
ASR1	327812	462536
ASR2	327938	462105
ASR3	326839	462822
ASR4	326087	462455
ASR5	326416	462929

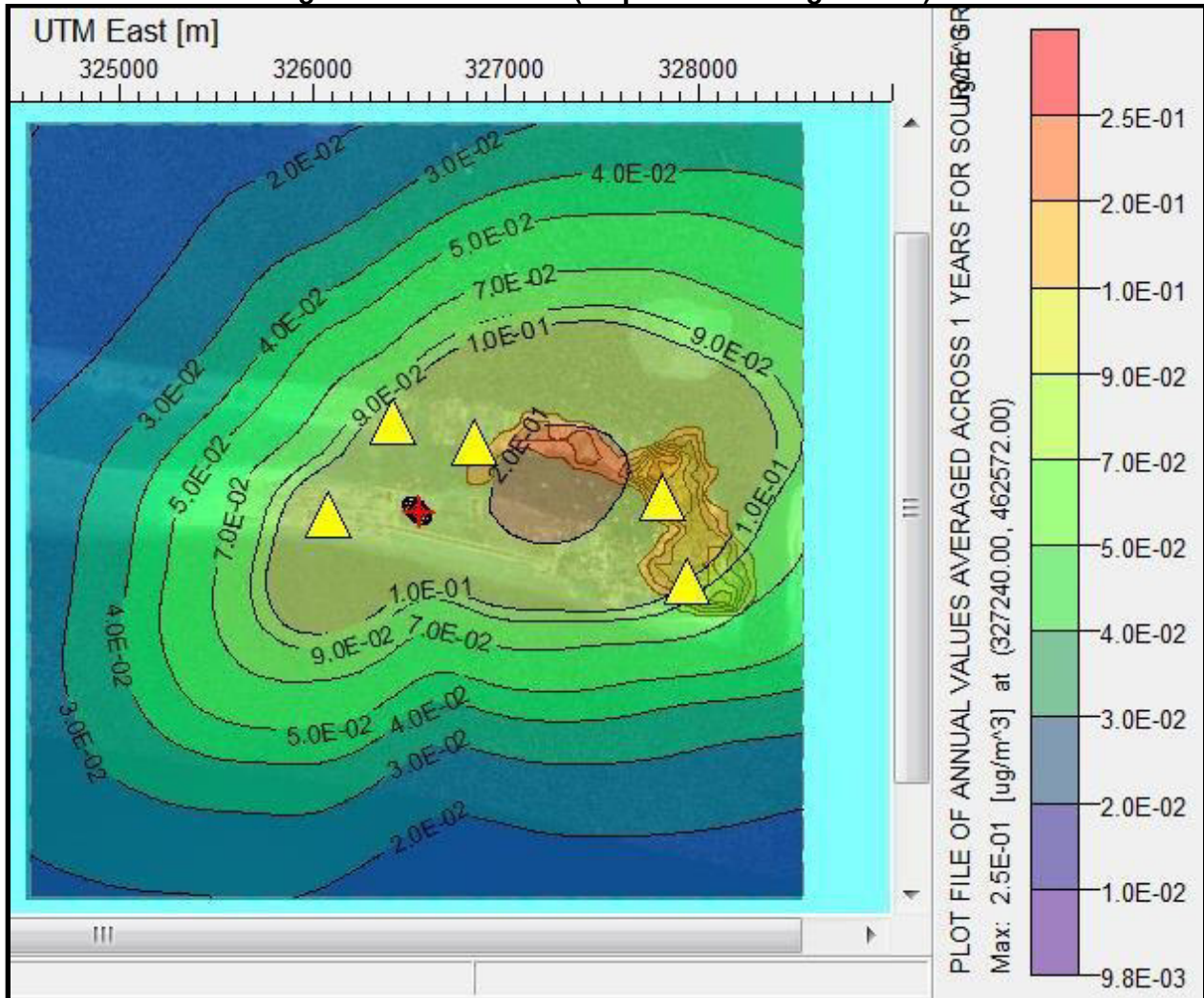
Figure 104: SO<sub>2</sub> 24 HR (Isopleth in microgram/m<sup>3</sup>)

LEGEND:

Yellow Triangles refer to identified Area Sensitive Receptor (ASRs)

	Long	Lat
ASR1	327812	462536
ASR2	327938	462105
ASR3	326839	462822
ASR4	326087	462455
ASR5	326416	462929

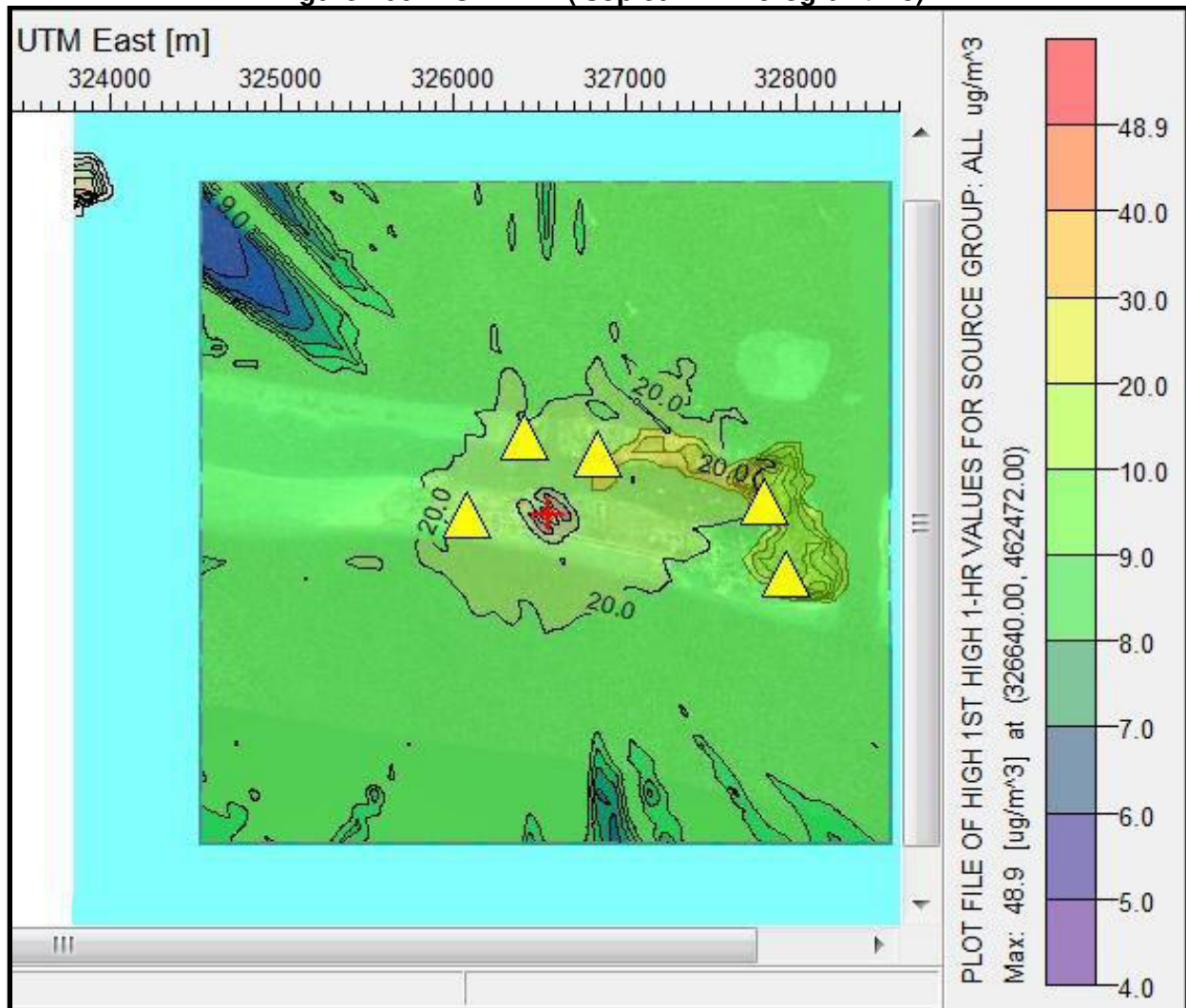
Figure 105: SO2 1 YR (Isopleth in microgram/m3)



LEGEND:

Yellow Triangles refer to identified Area Sensitive Receptor (ASRs)

	Long	Lat
ASR1	327812	462536
ASR2	327938	462105
ASR3	326839	462822
ASR4	326087	462455
ASR5	326416	462929

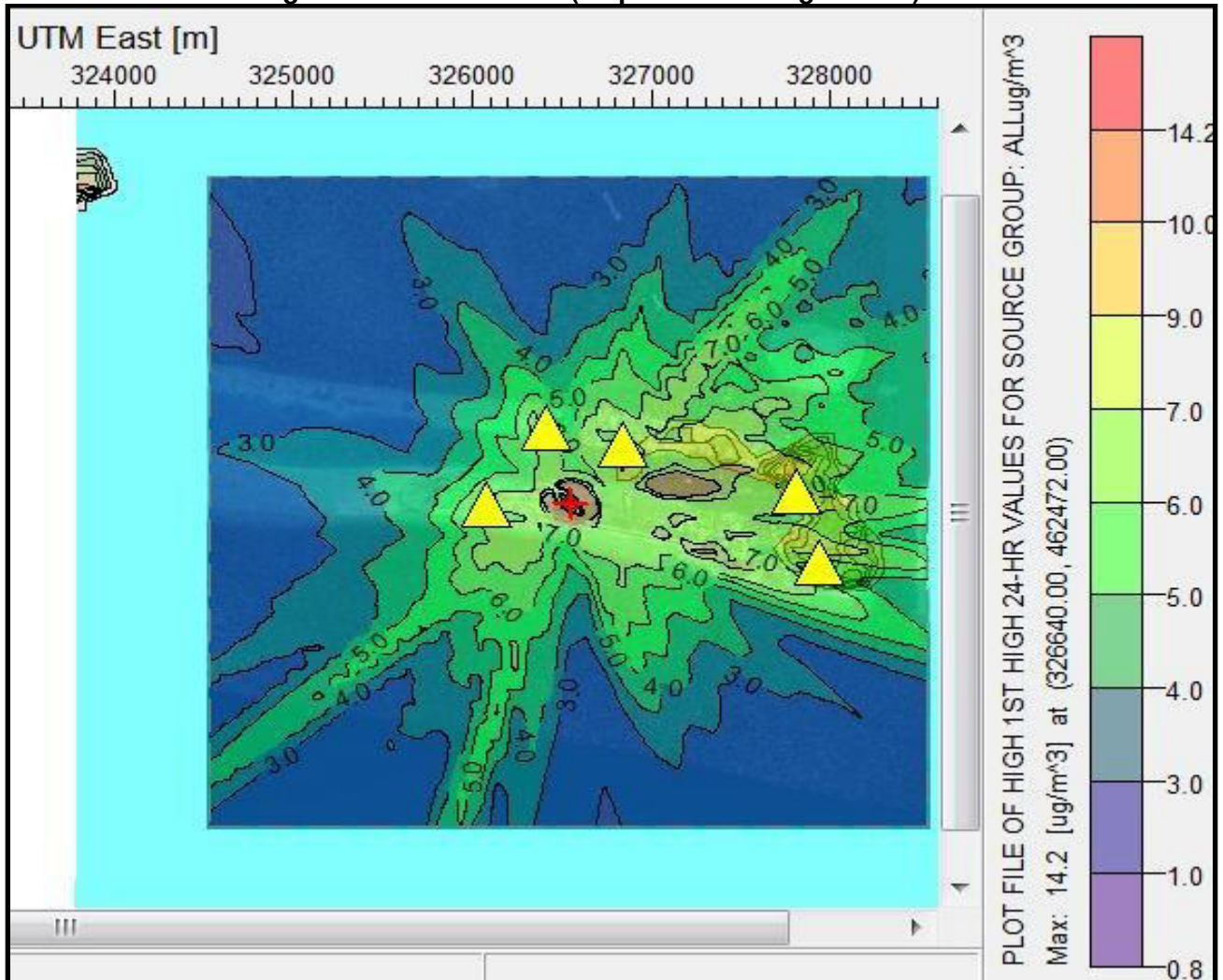
Figure 106: NO<sub>2</sub> 1 HR (Isopleth in microgram/m<sup>3</sup>)

LEGEND:

Yellow Triangles refer to identified Area Sensitive Receptor (ASRs)

	Long	Lat
ASR1	327812	462536
ASR2	327938	462105
ASR3	326839	462822
ASR4	326087	462455
ASR5	326416	462929

Figure 107: NO2 24 HR (Isopleth in microgram/m3)



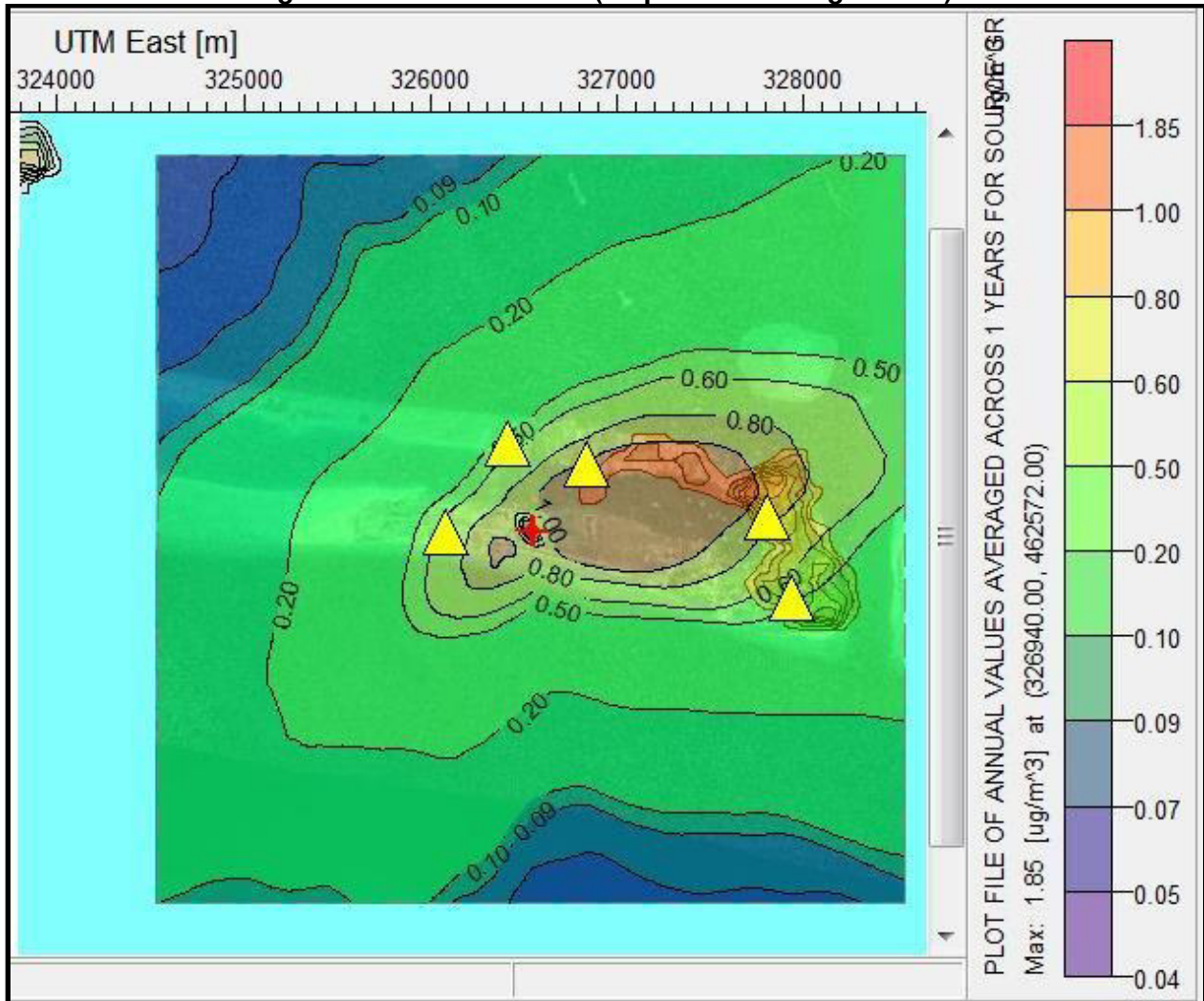
LEGEND:

Yellow Triangles refer to identified Area Sensitive Receptor (ASRs)

	Long	Lat
ASR1	327812	462536
ASR2	327938	462105
ASR3	326839	462822
ASR4	326087	462455
ASR5	326416	462929



Figure 108: NO2 1 YR HR (Isopleth in microgram/m3)

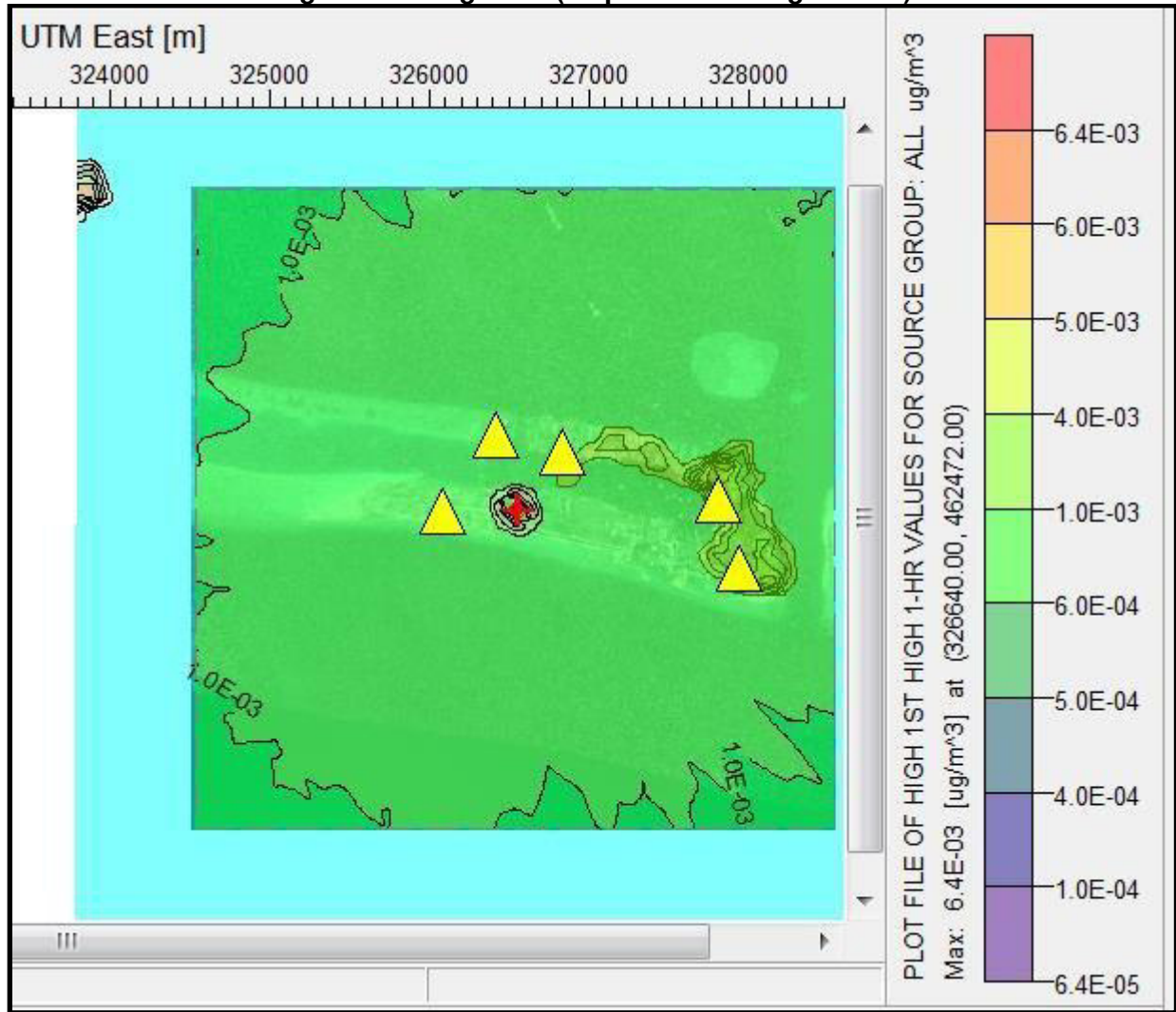


LEGEND:

Yellow Triangles refer to identified Area Sensitive Receptor (ASRs)

	Long	Lat
ASR1	327812	462536
ASR2	327938	462105
ASR3	326839	462822
ASR4	326087	462455
ASR5	326416	462929

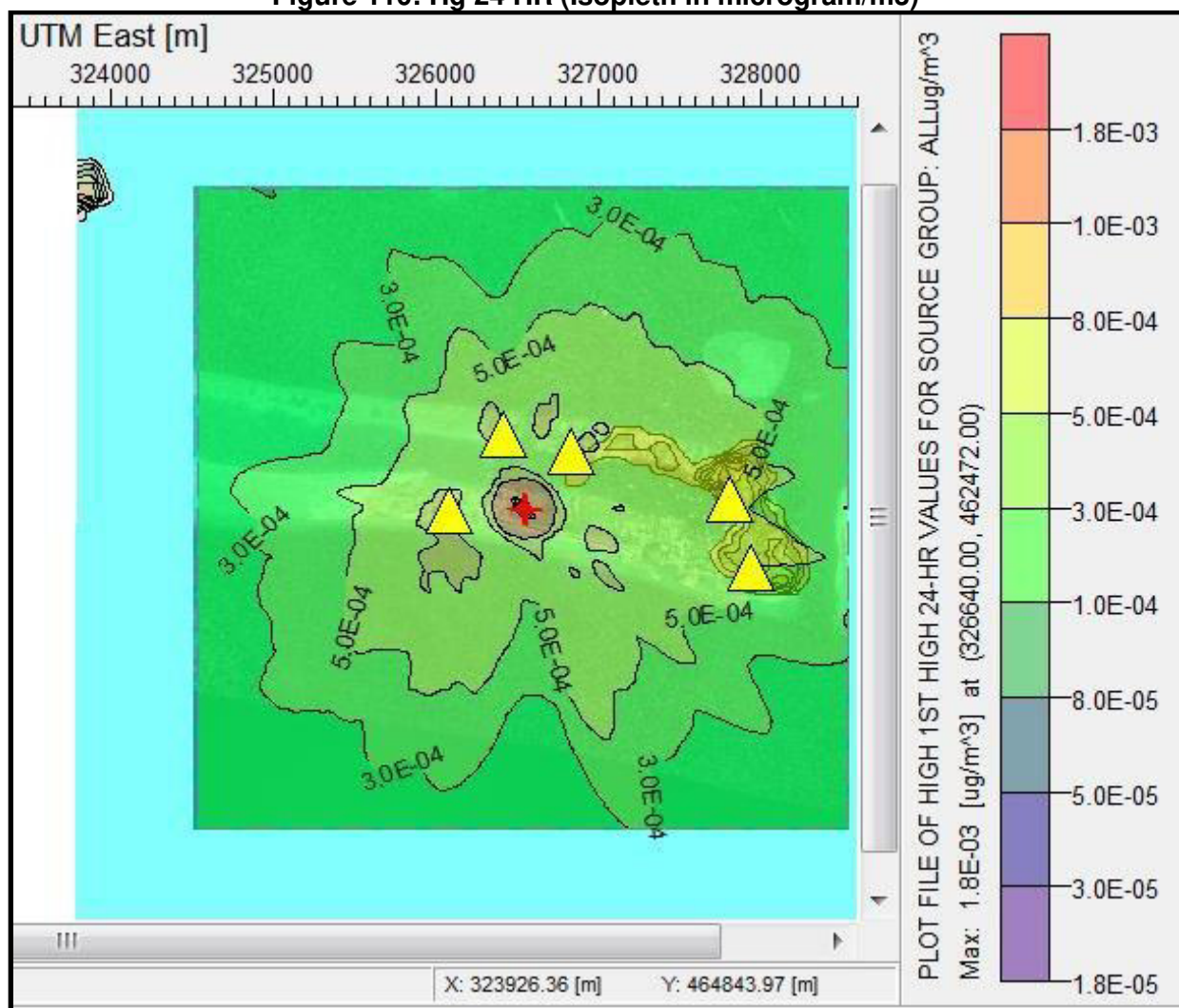
Figure 109: Hg 1 HR (Isopleth in microgram/m3)



LEGEND:

Yellow Triangles refer to identified Area Sensitive Receptor (ASRs)

	Long	Lat
ASR1	327812	462536
ASR2	327938	462105
ASR3	326839	462822
ASR4	326087	462455
ASR5	326416	462929

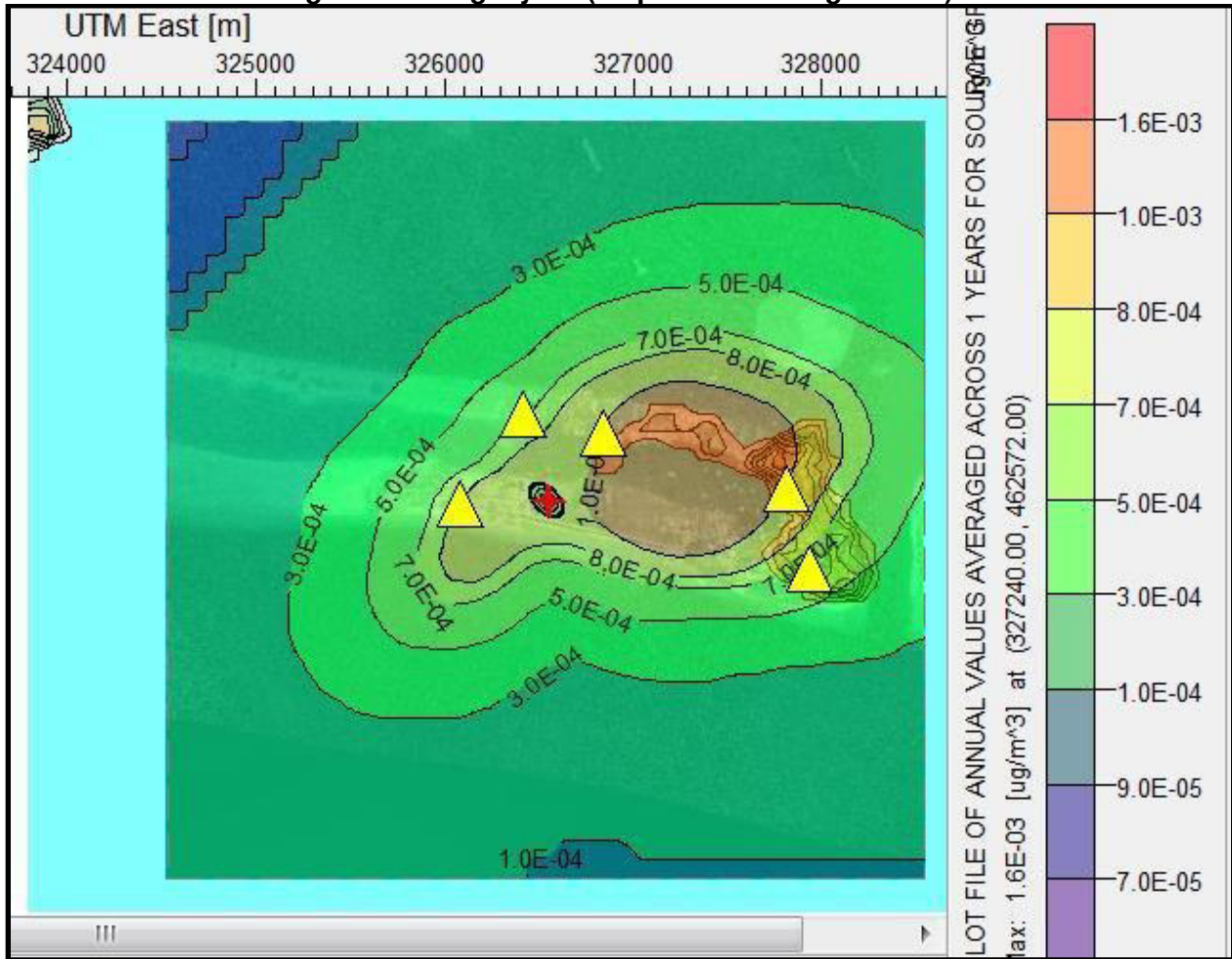
Figure 110: Hg 24 HR (Isopleth in microgram/m<sup>3</sup>)

LEGEND:

Yellow Triangles refer to identified Area Sensitive Receptor (ASRs)

	Long	Lat
ASR1	327812	462536
ASR2	327938	462105
ASR3	326839	462822
ASR4	326087	462455
ASR5	326416	462929

Figure 111: Hg 1 year (Isopleth in microgram/m3)

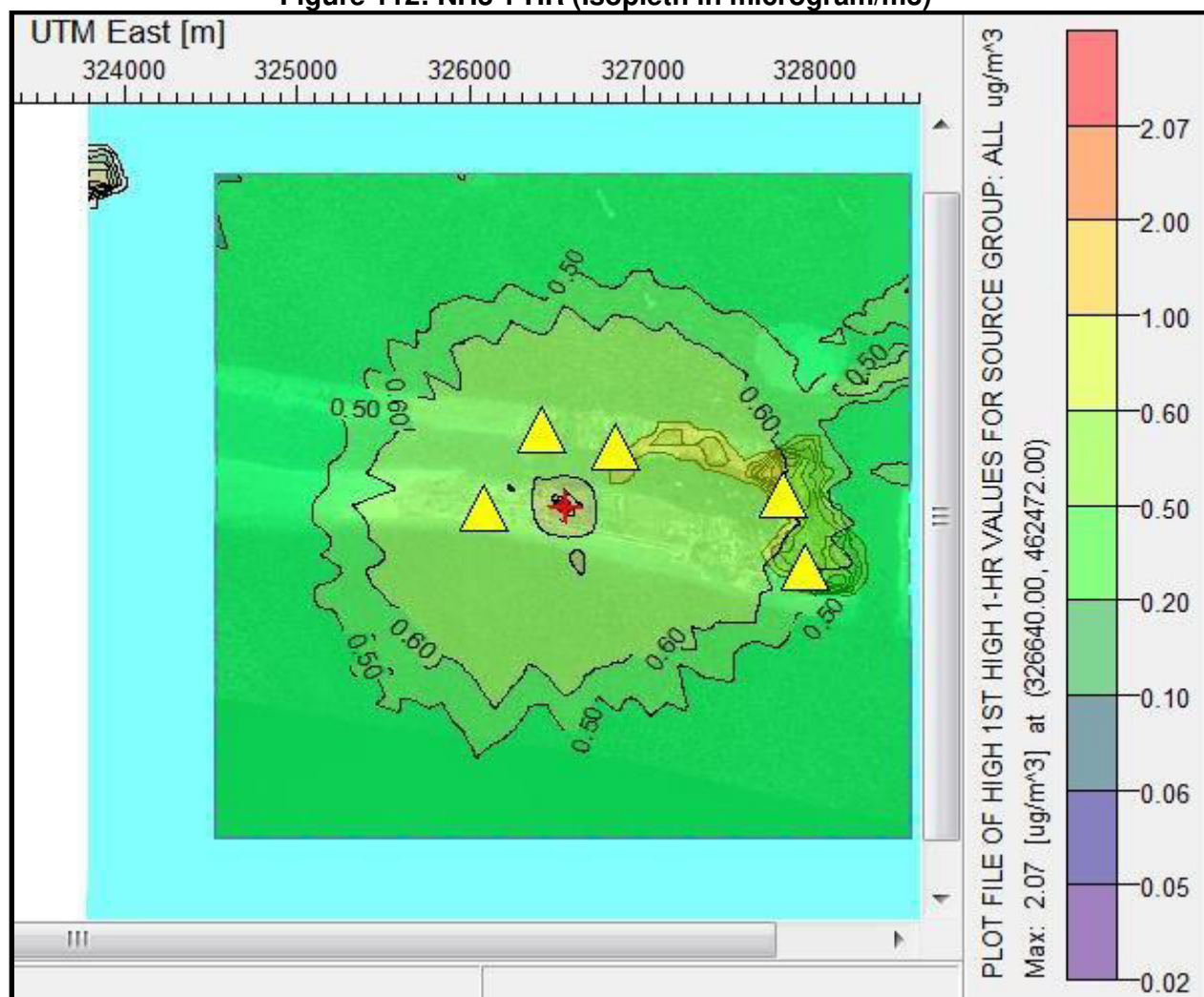


LEGEND:

Yellow Triangles refer to identified Area Sensitive Receptor (ASRs)

	Long	Lat
ASR1	327812	462536
ASR2	327938	462105
ASR3	326839	462822
ASR4	326087	462455
ASR5	326416	462929

Figure 112: NH3 1 HR (Isopleth in microgram/m3)

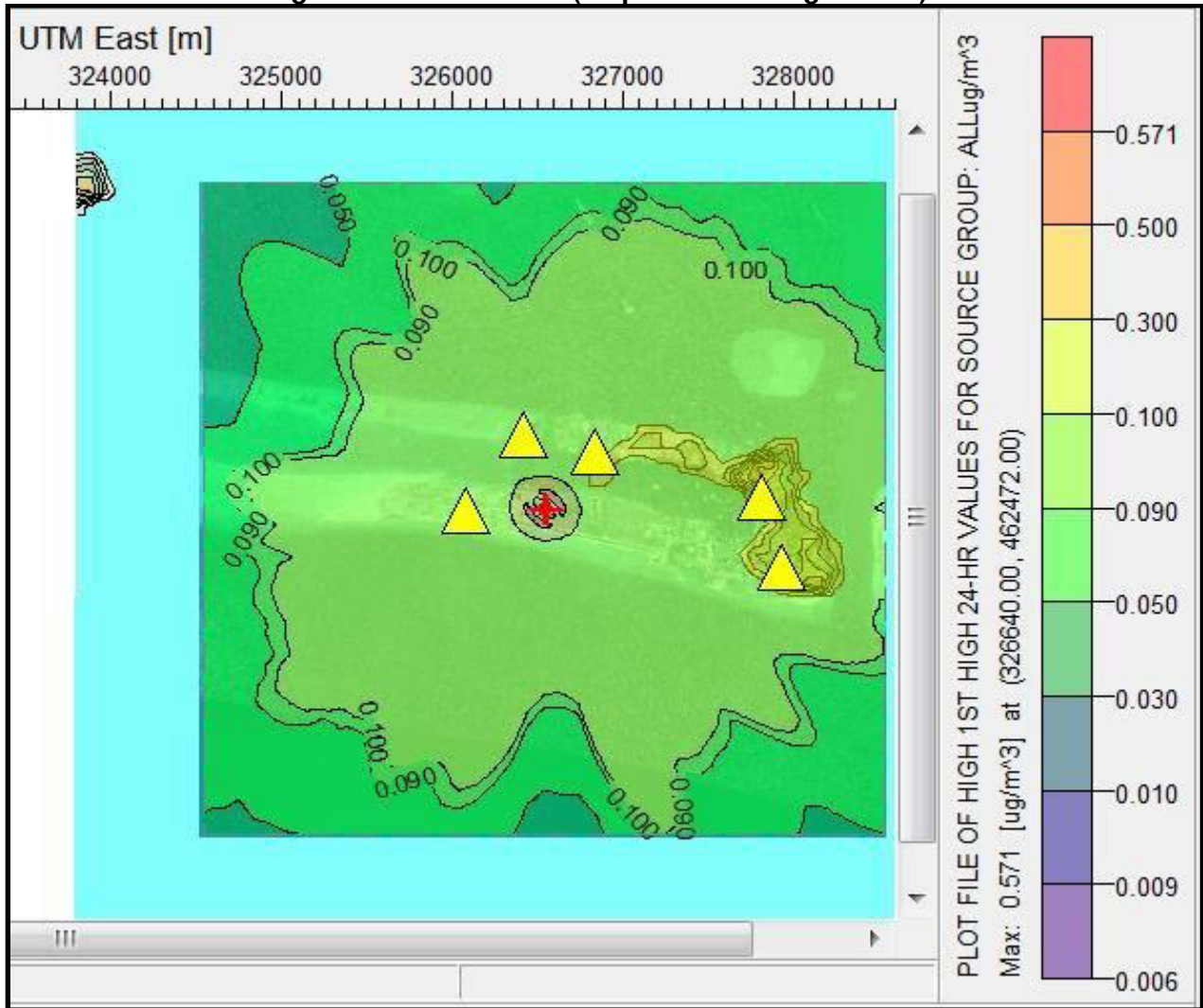


LEGEND:

Yellow Triangles refer to identified Area Sensitive Receptor (ASRs)

	Long	Lat
ASR1	327812	462536
ASR2	327938	462105
ASR3	326839	462822
ASR4	326087	462455
ASR5	326416	462929

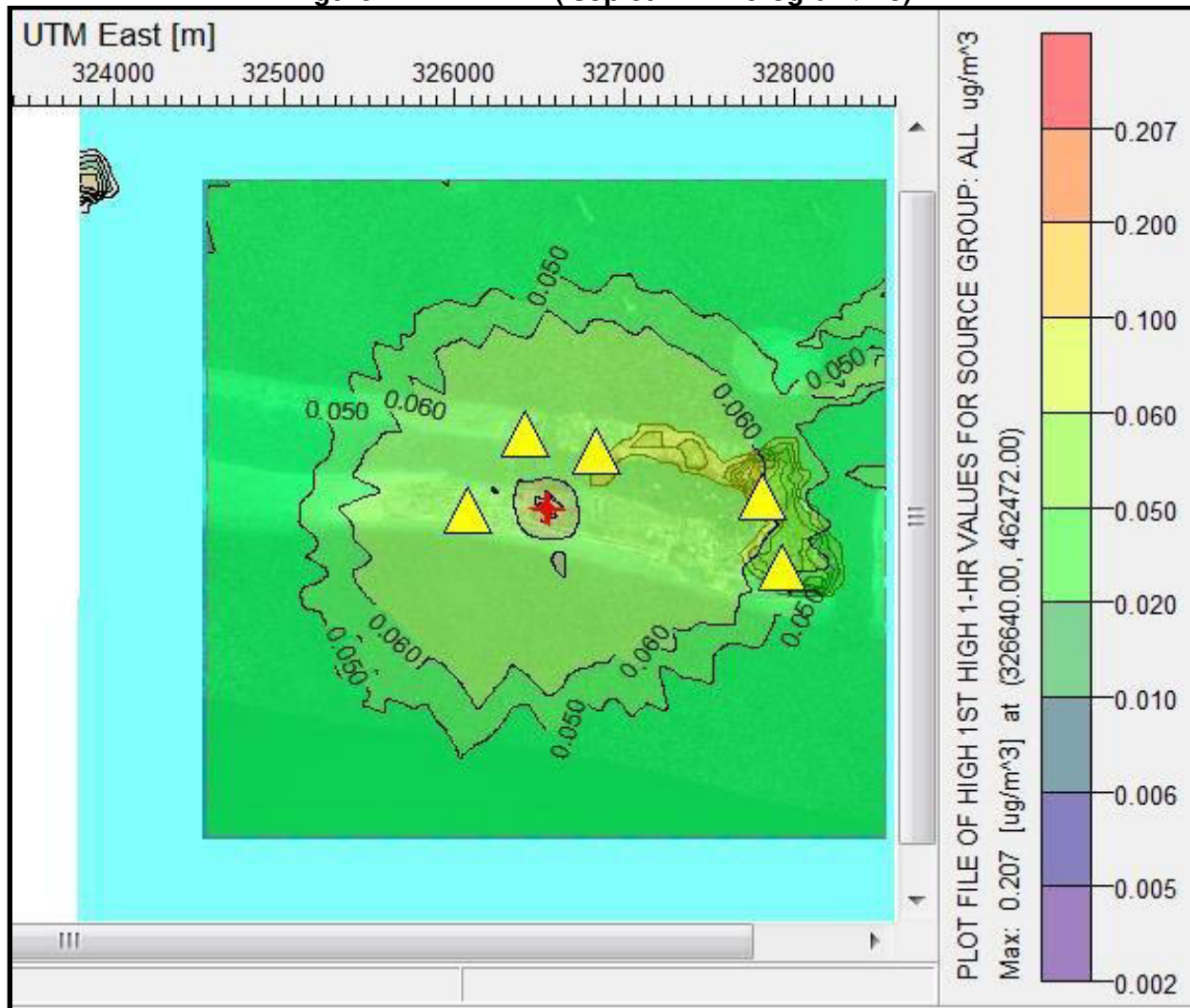
Figure 113: NH3 24 HR (Isopleth in microgram/m<sup>3</sup>)



LEGEND:

Yellow Triangles refer to identified Area Sensitive Receptor (ASRs)

	Long	Lat
ASR1	327812	462536
ASR2	327938	462105
ASR3	326839	462822
ASR4	326087	462455
ASR5	326416	462929

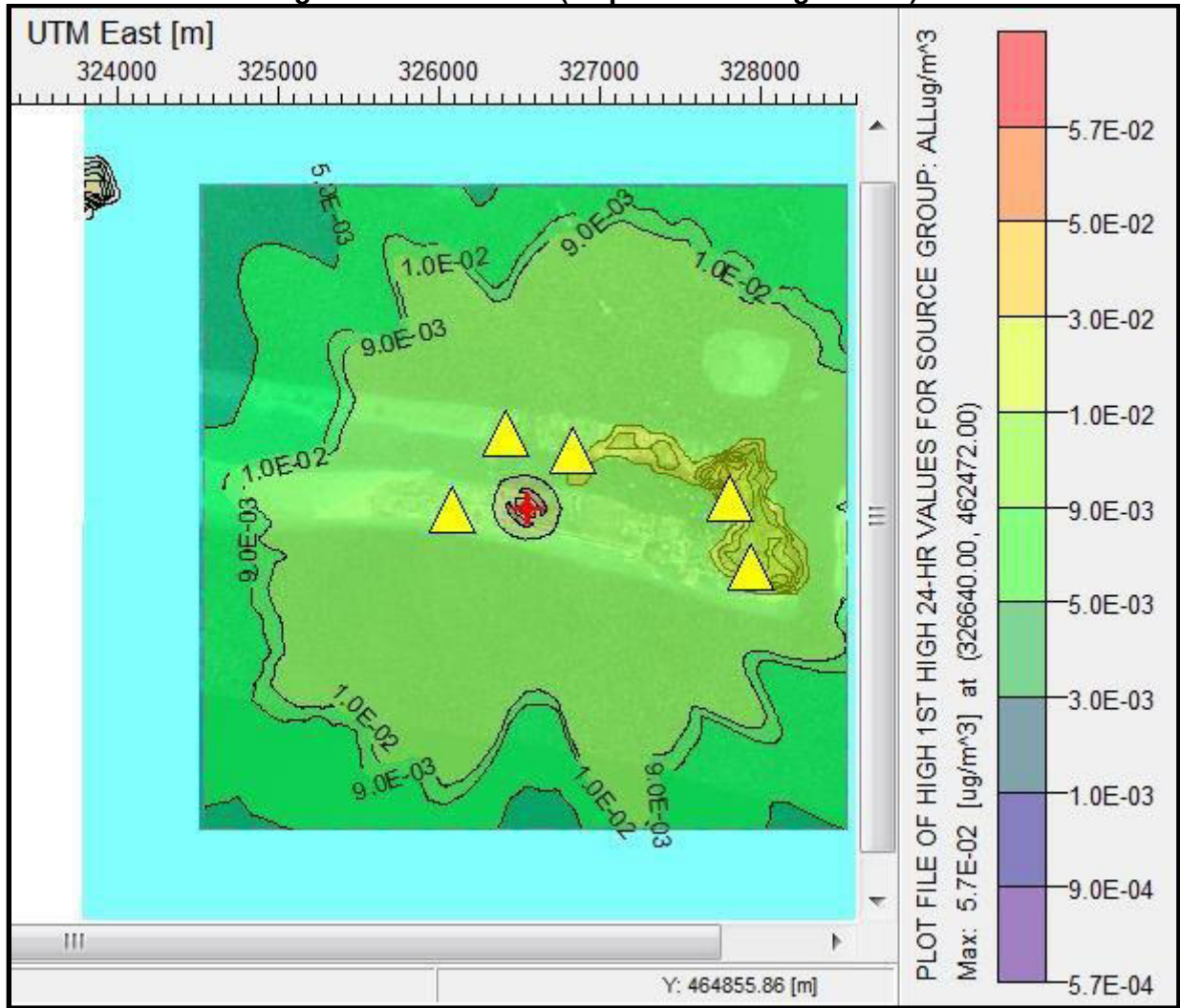
Figure 114: Hf 1 HR (Isopleth in microgram/m<sup>3</sup>)

LEGEND:

Yellow Triangles refer to identified Area Sensitive Receptor (ASRs)

	Long	Lat
ASR1	327812	462536
ASR2	327938	462105
ASR3	326839	462822
ASR4	326087	462455
ASR5	326416	462929

Figure 115: HF 24 HR (Isopleth in microgram/m<sup>3</sup>)



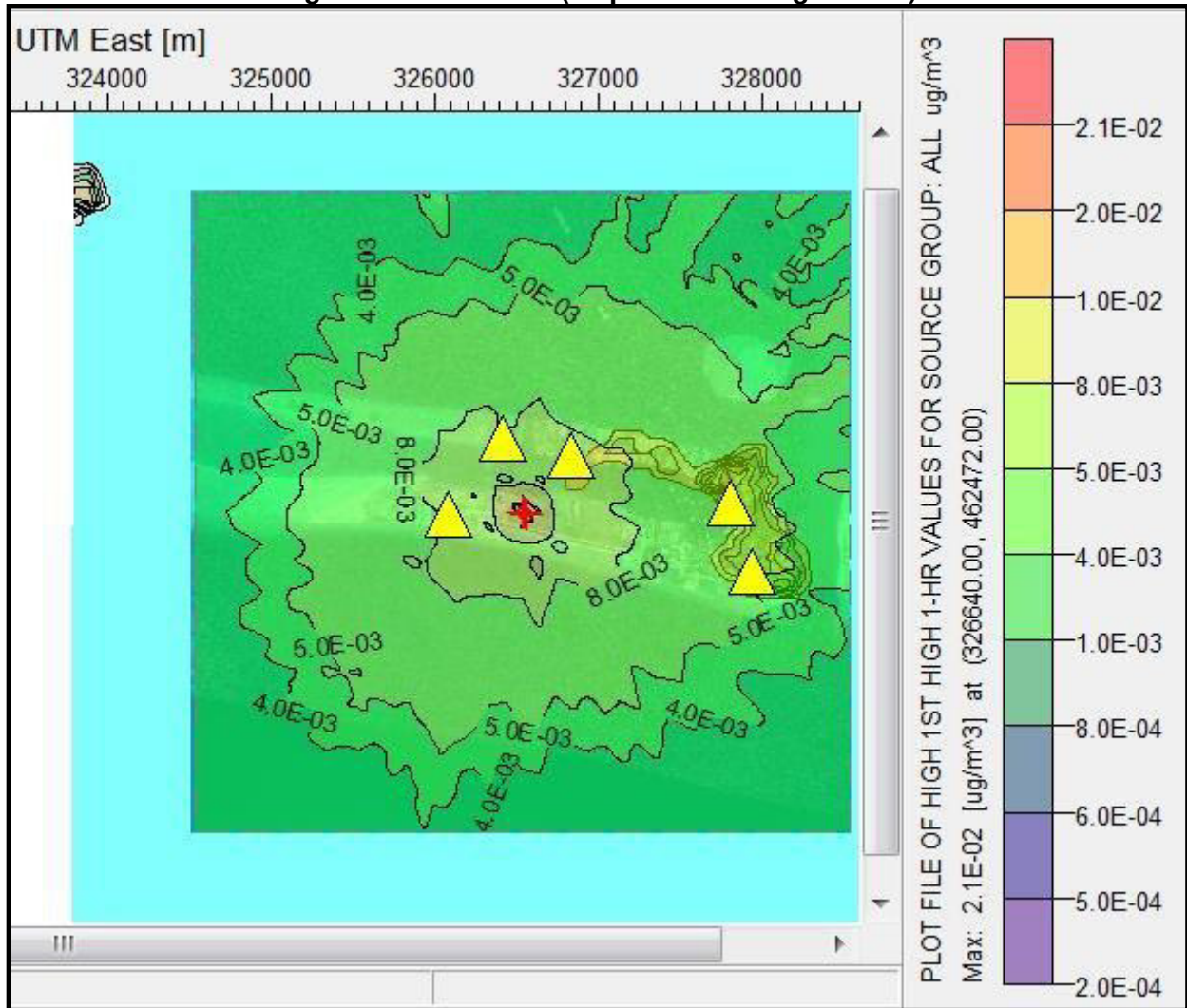
LEGEND:

Yellow Triangles refer to identified Area Sensitive Receptor (ASRs)

	Long	Lat
ASR1	327812	462536
ASR2	327938	462105
ASR3	326839	462822
ASR4	326087	462455
ASR5	326416	462929



Figure 116: D/F 1 HR (Isopleth in microgram/m3)

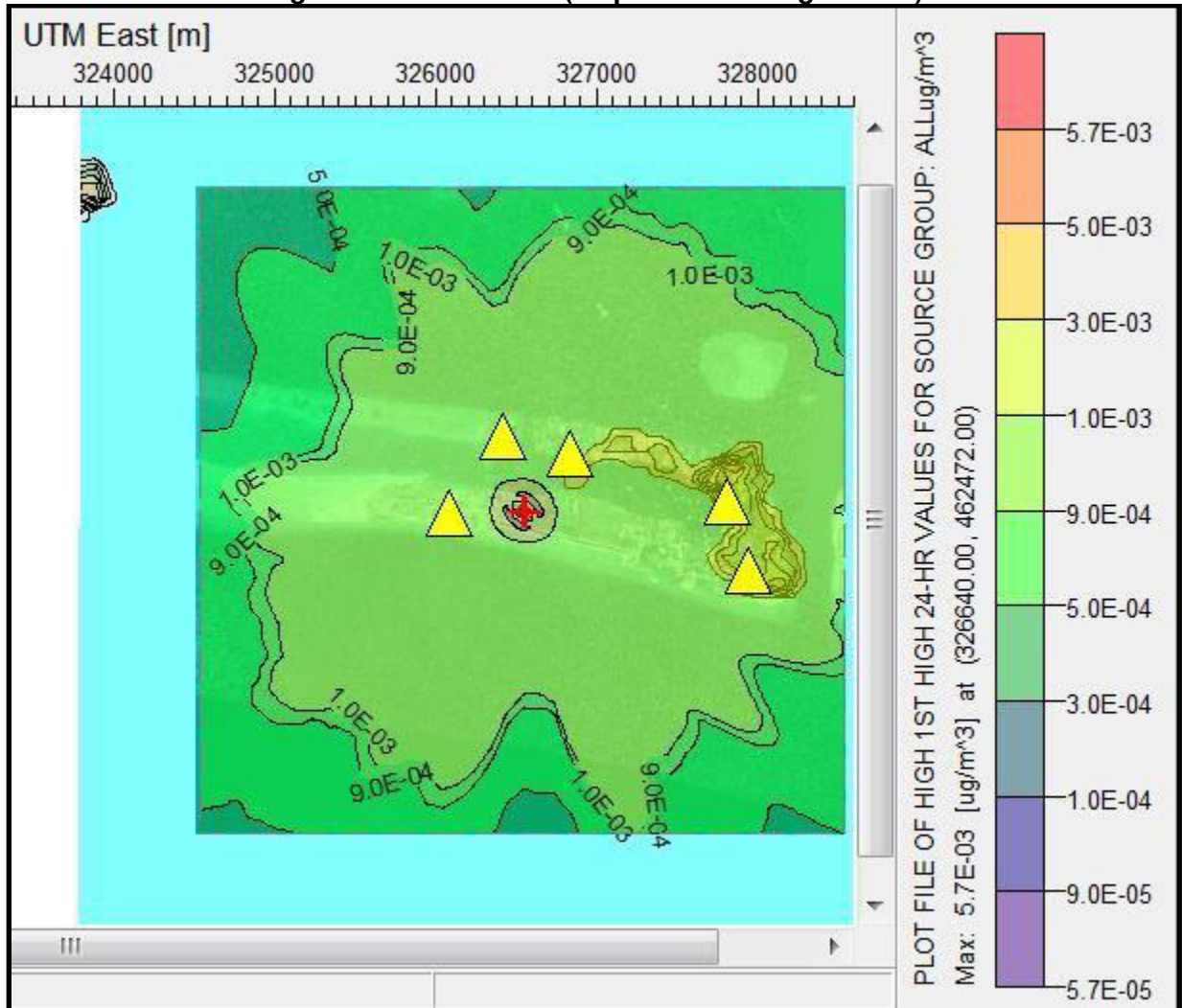


LEGEND:

Yellow Triangles refer to identified Area Sensitive Receptor (ASRs)

	Long	Lat
ASR1	327812	462536
ASR2	327938	462105
ASR3	326839	462822
ASR4	326087	462455
ASR5	326416	462929

Figure 117: D/F 24 HR (Isopleth in microgram/m<sup>3</sup>)

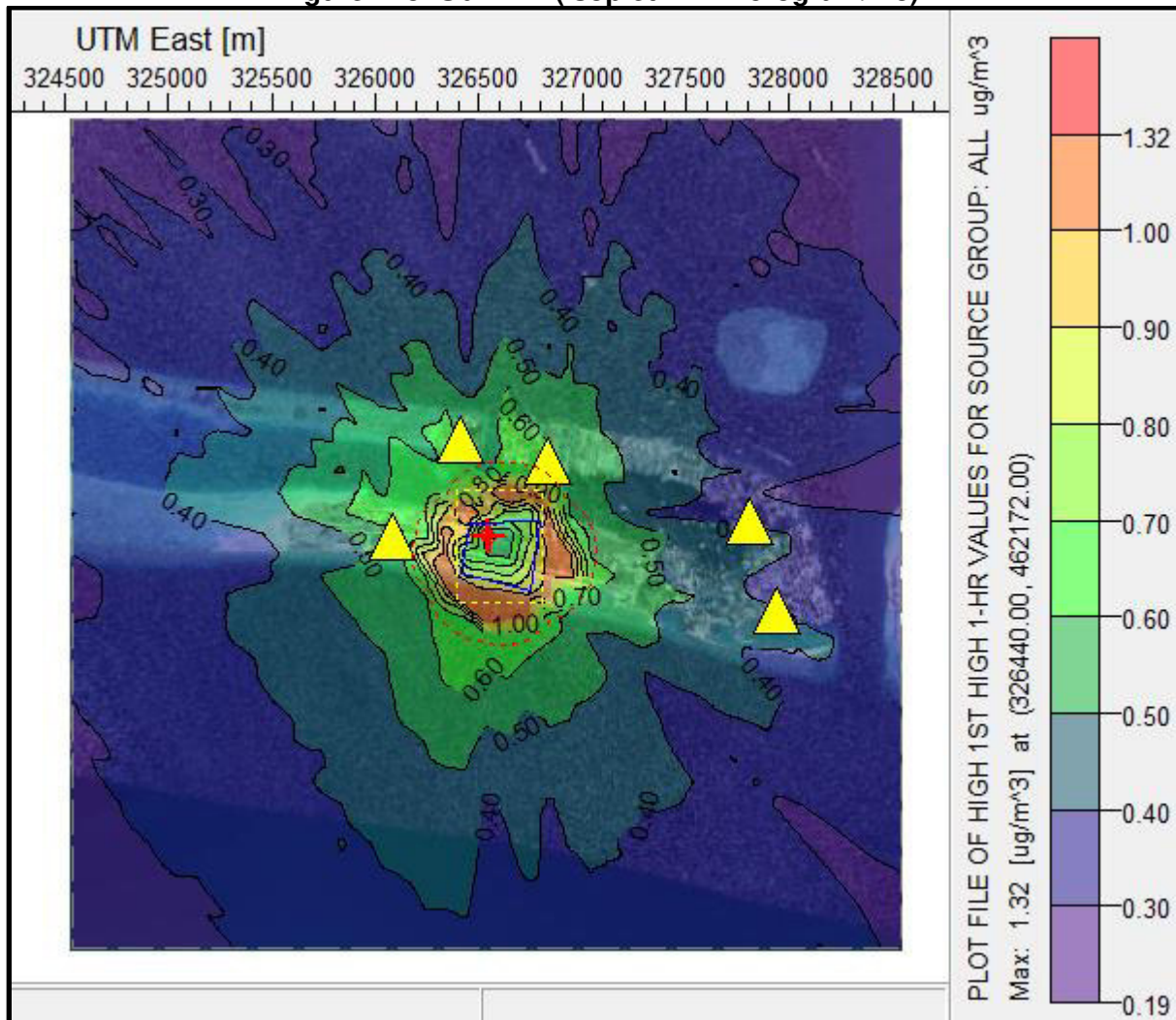


LEGEND:

Yellow Triangles refer to identified Area Sensitive Receptor (ASRs)

	Long	Lat
ASR1	327812	462536
ASR2	327938	462105
ASR3	326839	462822
ASR4	326087	462455
ASR5	326416	462929

Figure 118: Sb 1 HR (Isopleth in microgram/m3)

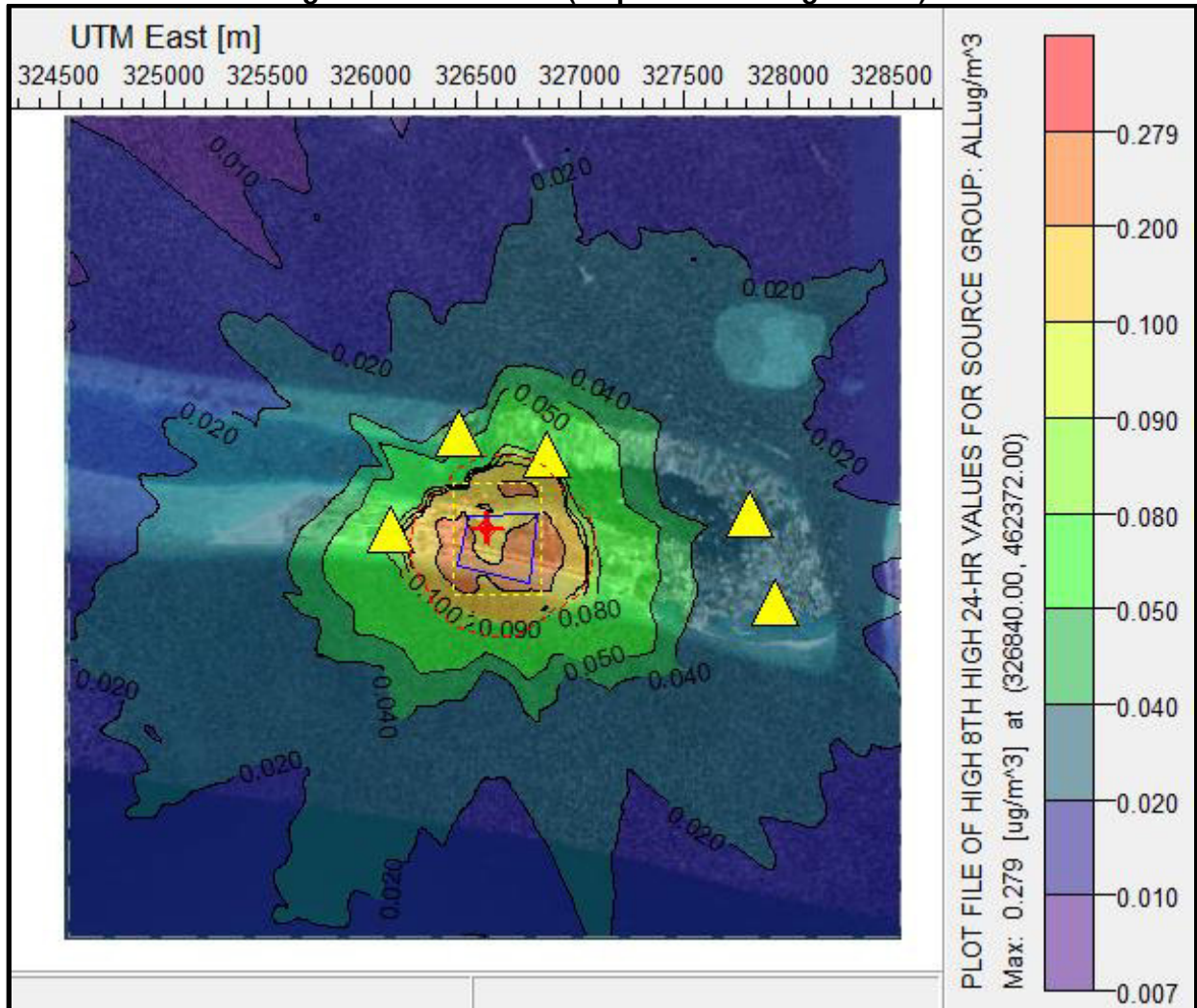


LEGEND:

Yellow Triangles refer to identified Area Sensitive Receptor (ASRs)

	Long	Lat
ASR1	327812	462536
ASR2	327938	462105
ASR3	326839	462822
ASR4	326087	462455
ASR5	326416	462929

Figure 119: Sb 24 HR (Isopleth in microgram/m<sup>3</sup>)

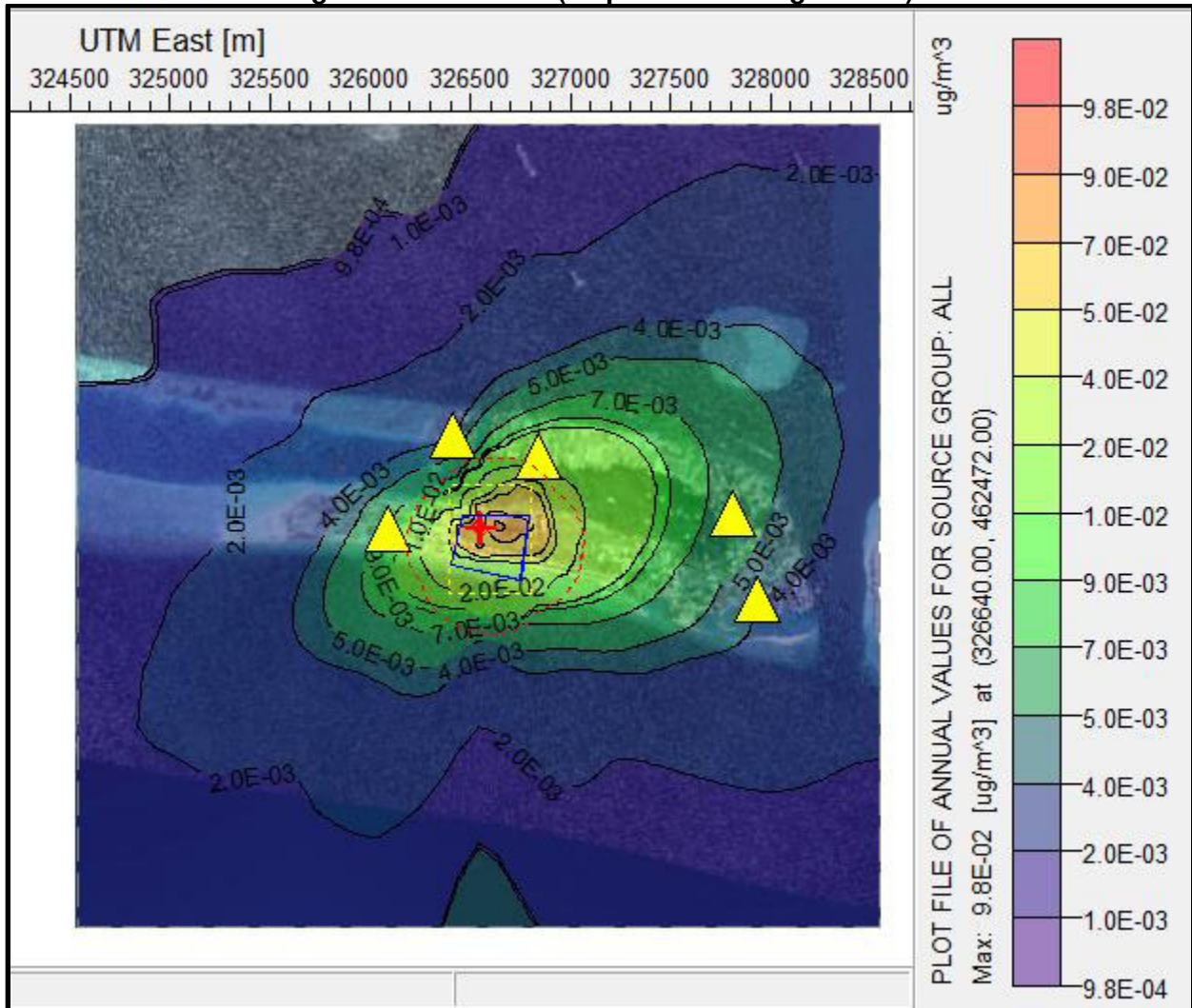


LEGEND:

Yellow Triangles refer to identified Area Sensitive Receptor (ASRs)

	Long	Lat
ASR1	327812	462536
ASR2	327938	462105
ASR3	326839	462822
ASR4	326087	462455
ASR5	326416	462929

Figure 120: Sb 1 YR (Isopleth in microgram/m3)

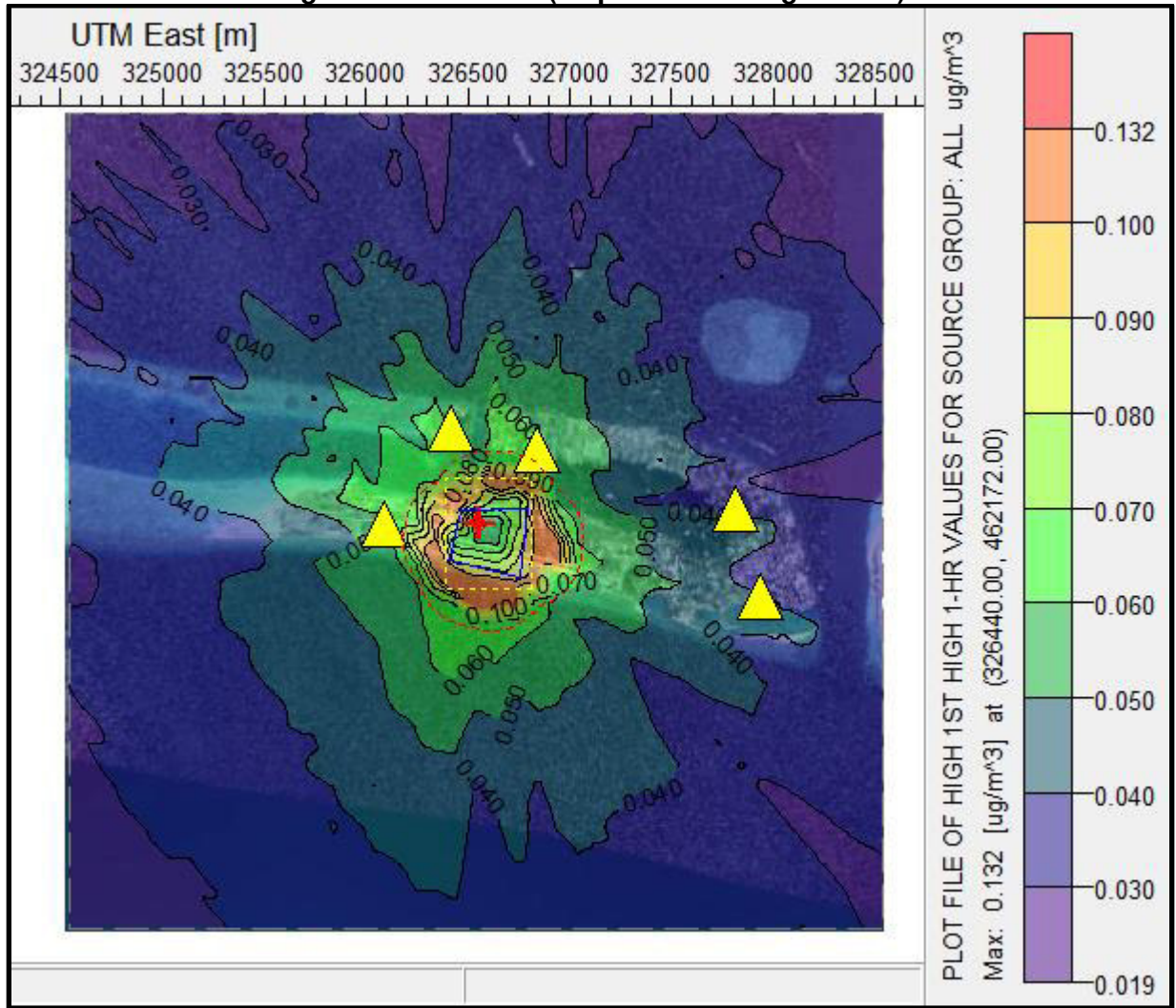


LEGEND:

Yellow Triangles refer to identified Area Sensitive Receptor (ASRs)

	Long	Lat
ASR1	327812	462536
ASR2	327938	462105
ASR3	326839	462822
ASR4	326087	462455
ASR5	326416	462929

Figure 121: As 1 HR (Isopleth in microgram/m3)

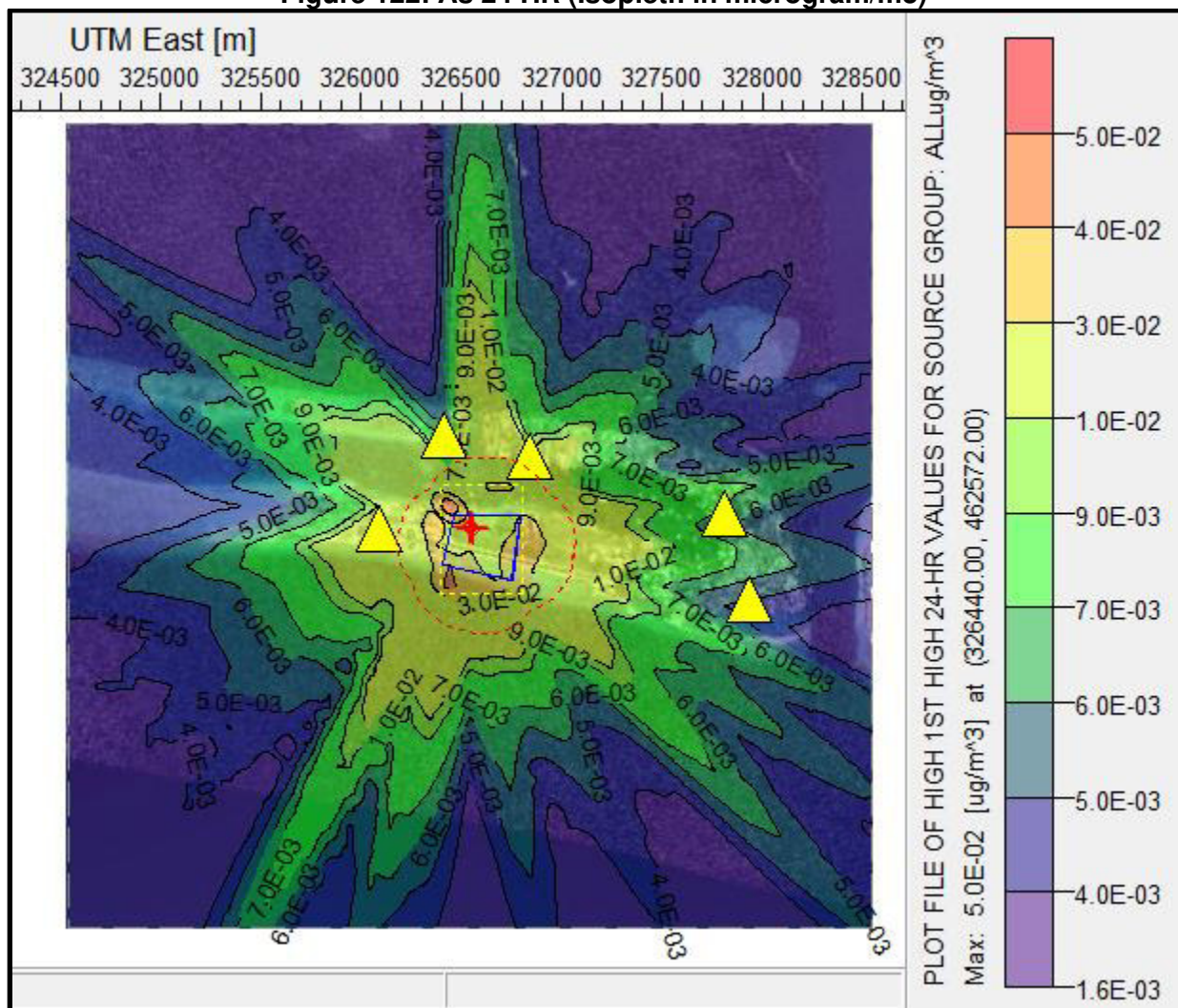


LEGEND:

Yellow Triangles refer to identified Area Sensitive Receptor (ASRs)

	Long	Lat
ASR1	327812	462536
ASR2	327938	462105
ASR3	326839	462822
ASR4	326087	462455
ASR5	326416	462929

Figure 122: As 24 HR (Isopleth in microgram/m<sup>3</sup>)

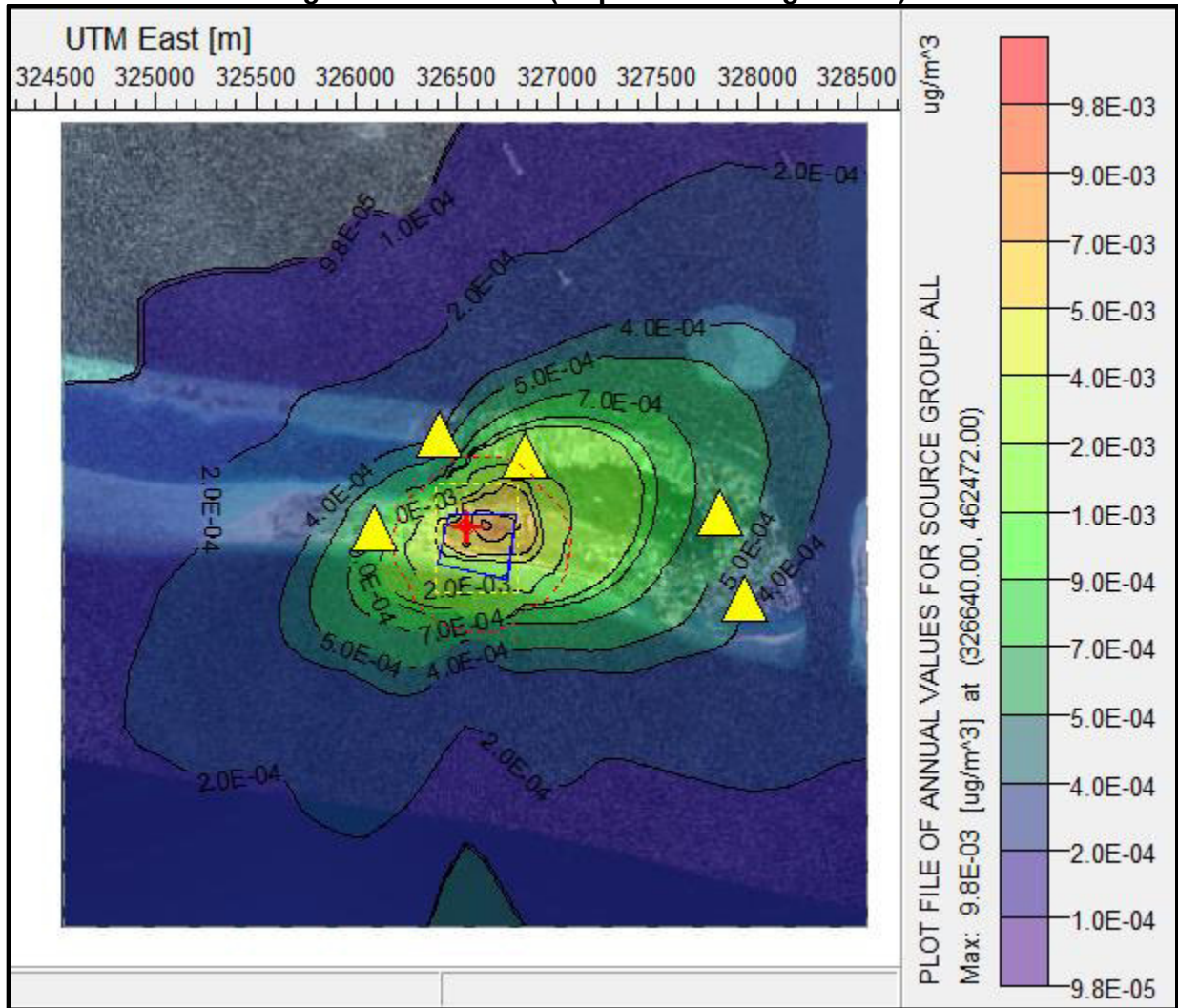


LEGEND:

Yellow Triangles refer to identified Area Sensitive Receptor (ASRs)

	Long	Lat
ASR1	327812	462536
ASR2	327938	462105
ASR3	326839	462822
ASR4	326087	462455
ASR5	326416	462929

Figure 123: As 1 YR (Isopleth in microgram/m<sup>3</sup>)



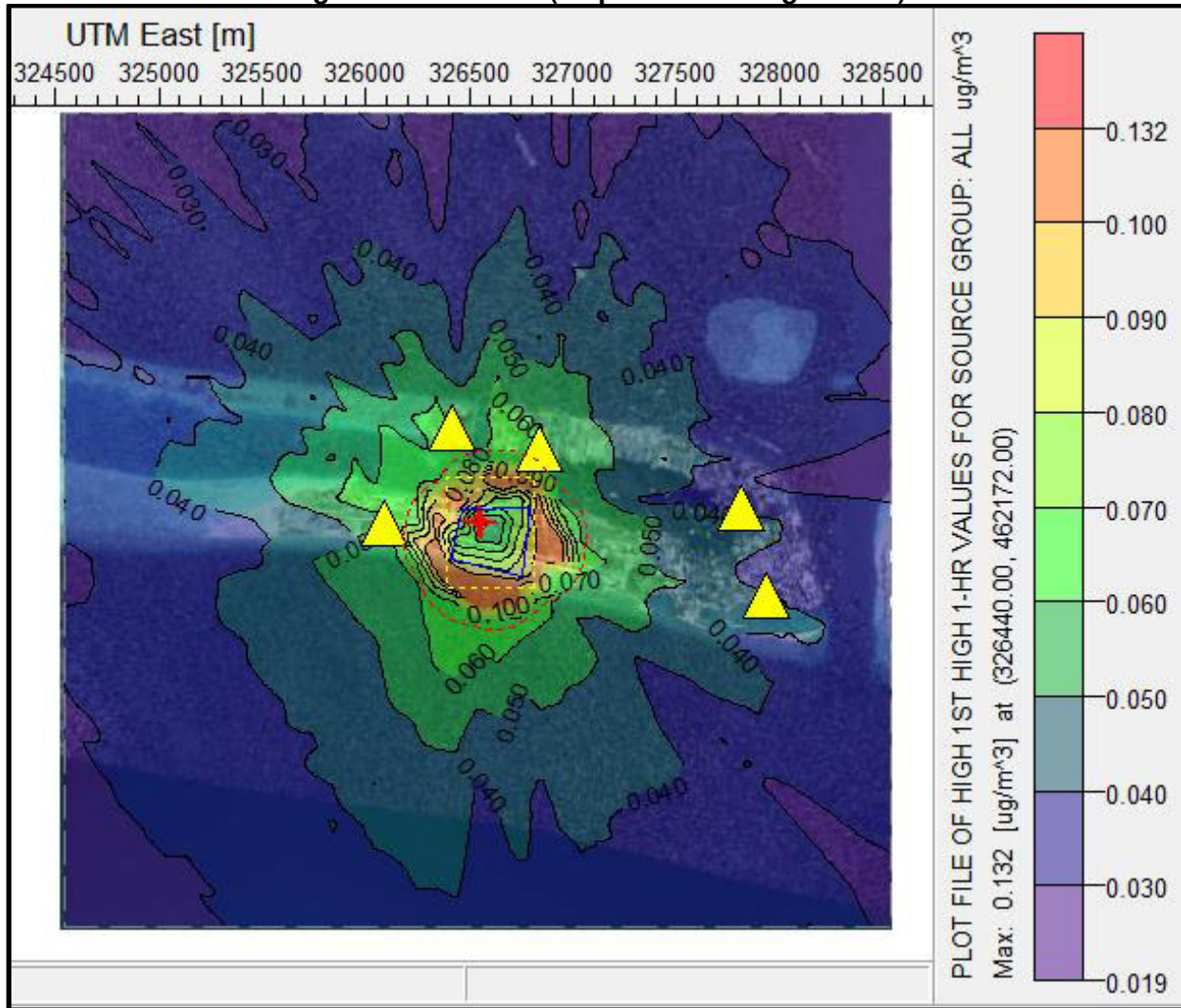
LEGEND:

Yellow Triangles refer to identified Area Sensitive Receptor (ASRs)

	Long	Lat
ASR1	327812	462536
ASR2	327938	462105
ASR3	326839	462822
ASR4	326087	462455
ASR5	326416	462929



Figure 124: TI 1 HR (Isopleth in microgram/m3)

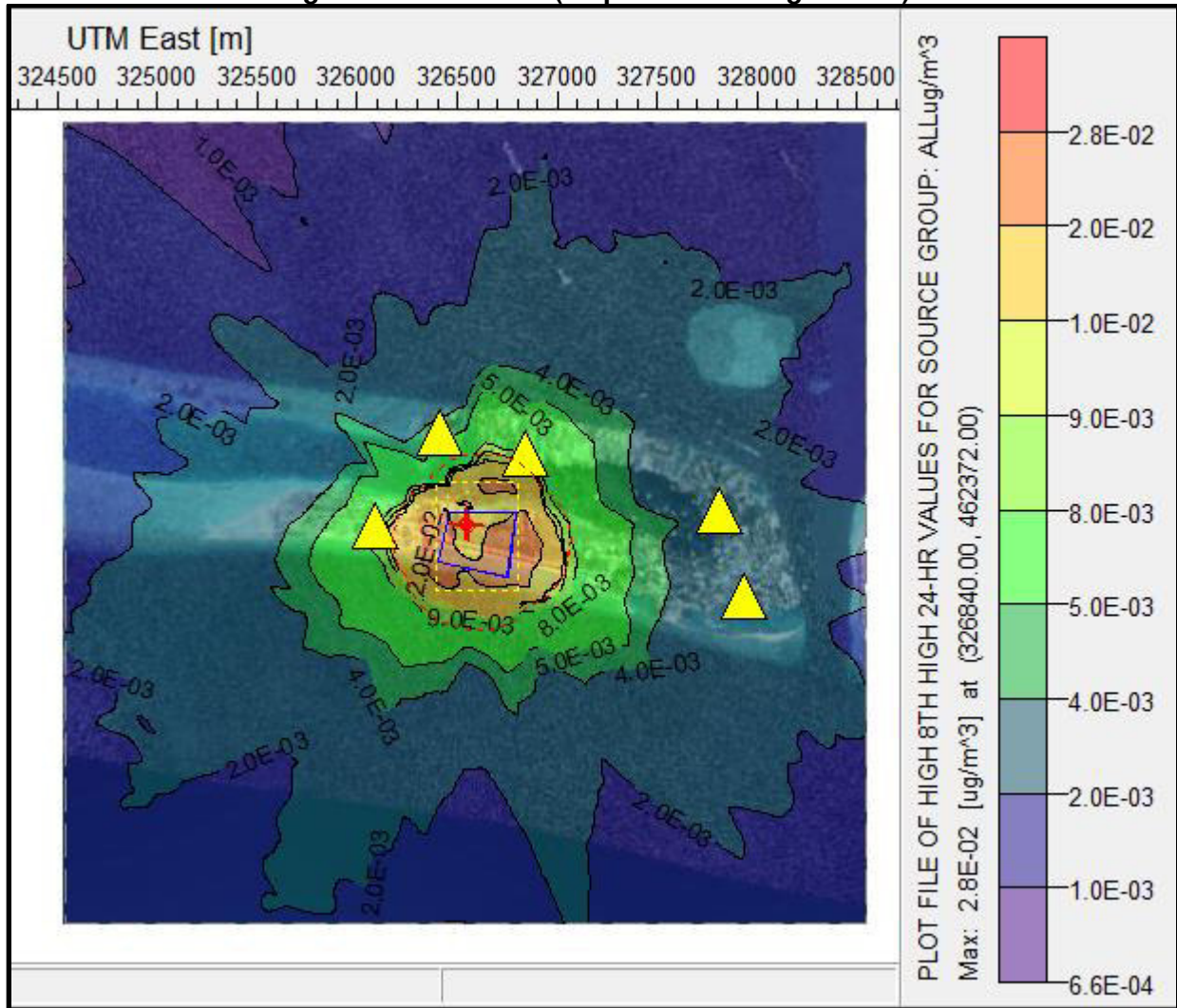


LEGEND:

Yellow Triangles refer to identified Area Sensitive Receptor (ASRs)

	Long	Lat
ASR1	327812	462536
ASR2	327938	462105
ASR3	326839	462822
ASR4	326087	462455
ASR5	326416	462929

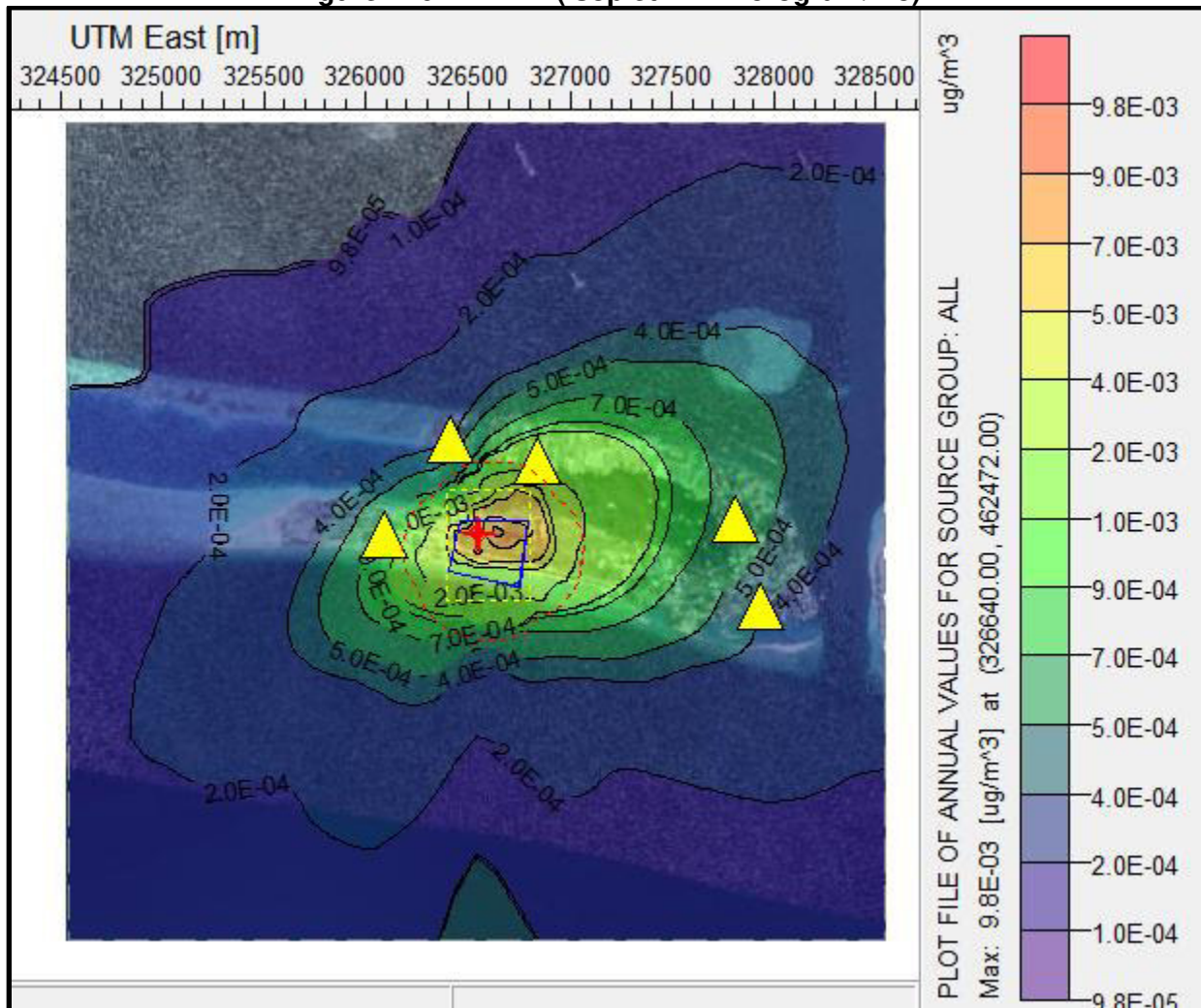
Figure 125: TI 24 HR (Isopleth in microgram/m<sup>3</sup>)



LEGEND:

Yellow Triangles refer to identified Area Sensitive Receptor (ASRs)

	Long	Lat
ASR1	327812	462536
ASR2	327938	462105
ASR3	326839	462822
ASR4	326087	462455
ASR5	326416	462929

Figure 126: TI 1 YR (Isopleth in microgram/m<sup>3</sup>)

LEGEND:

Yellow Triangles refer to identified Area Sensitive Receptor (ASRs)

	Long	Lat
ASR1	327812	462536
ASR2	327938	462105
ASR3	326839	462822
ASR4	326087	462455
ASR5	326416	462929

476. For all the above parameters, controlled emissions have been validated to be in compliance with the TA Luft Standards as provided in the Austal2000 Report and with the USEPA standards and the WHO Air Quality Guidelines.

477. **Results.** AERMOD validation of the Austal2000 model results shows slightly higher results than the Austal2000 report but still within TA Luft Standards and USEPA Standards. For the deposition results, Total Dust, SO<sub>2</sub>, NO<sub>2</sub> and Hg are confirmed to be way below the 1-year TA Luft precipitation standards. Three groups of toxic heavy metals were also run in the AERMOD validation model to show the potential maximum ground level concentrations using the design emission data. However, the results of the run for these group of heavy metals are for presentation only considering that there are no standards to compare them with.

478. Based on the design emission of the proposed WTE plant, proposed stack height of 50 meters in the Austal2000 report was found to be favorable considering all predicted ground level concentrations in the AERMOD validation model are below the TA Luft and USEPA standards. The complete report on the AERMOD Modeling is in Appendix 7.

**Table 46: Summary Maximum Ground Level Concentration - AERMOD**

MAXIMUM GROUND LEVEL CONCENTRATION						German Standards (TA Luft)		USEPA	WHO Air Quality Guidelines	% of the WHO Standards	Non- degraded <sup>a</sup> >25%	Degraded <sup>a</sup> >10% short term >1% long term)
Parameters	Ave. Time	Conc (ug/Nm <sup>3</sup> )	Deposition (g/m <sup>2</sup> )	X	Y	Conc (ug/Nm <sup>3</sup> )	Deposition (g/m <sup>2</sup> )	Conc (ug/Nm <sup>3</sup> )	Conc (ug/Nm <sup>3</sup> )	%		
Total Dust	1 hour	7.60628	0.00754	327040	462672	-	-	-	-	-	-	-
Total Dust	24 hours	3.18863	0.03805	327140	462572	-	-	-	-	-	-	-
Total Dust	1 year	0.34134	0.43994	326840	462572	-	0.35	-	-	-	-	-
PM10	1 hour	0.10288	0.00037	326640	462472	-	-	-	20	0.51	N	N
PM10	24 hours	0.02844	0.00078	326640	462472	50	-	150	50	0.06	N	N
PM10	1 year	0.0025	0.02508	327240	462572	40	-	50	20	0.01	N	N
SO2	1 hour	10.3398	-	326640	462472	350	-	212	-	4.88	N	N
SO2	24 hours	2.85793	-	326640	462472	125	-	365	20	14.29	N	Y
SO2	1 year	0.25302	-	327240	462572	50	-	79	-	0.32	N	N
NO2(NOx)	1 hour	48.91013	-	326640	462472	200	-	100 ppb	200	24.46	N	Y
NO2(NOx)	24 hours	14.16085	-	326640	462472	-	-	-	-	-	-	-
NO2(NOx)	1 year	2.1	-	324540	460472	40	-	53 ppb	40	5.25	N	Y
Hg	1 hour	0.00643	-	326640	462472	-	-	-	-	-	-	-
Hg	24 hours	0.00178	-	326640	462472	-	1	-	-	-	-	-
Hg	1 year	0.00157	-	327240	462572	-	0.05	-	-	-	-	-
NH3	1 hour	2.06667	-	326640	462472	-	-	-	-	-	-	-
NH3	24 hours	0.57123	-	326640	462472	-	-	-	-	-	-	-
NH3	1 year	0.00147	-	326340	461872	-	-	-	-	-	-	-
HCl	1 hour	2.06667	-	326540	462472	-	-	-	-	-	-	-
HCl	24 hours	0.57123	-	326540	462472	-	-	-	-	-	-	-
HCl	1 year	0.00147	-	324540	460472	-	-	-	-	-	-	-
Hf	1 hour	0.20705	-	326640	462472	-	-	-	-	-	-	-

MAXIMUM GROUND LEVEL CONCENTRATION						German Standards (TA Luft)		USEPA	WHO Air Quality Guidelines	% of the WHO Standards	Non- degraded <sup>a</sup> >25%	Degraded <sup>a</sup> >10% short term >1% long term)
Hf	24 hours	0.05723	-	326640	462472	-	-	-	-	-	-	-
Hf	1 year	0.00015	-	324540	460472	-	-	-	-	-	-	-
D/F	1 hour	0.02058	-	326640	462472	-	-	-	-	-	-	-
D/F	24 hours	0.00569	-	326640	462472	-	-	-	-	-	-	-
D/F	1 year	0.00002	-	324540	460472	-	-	-	-	-	-	-
Sum of Metals (Sb) <sup>b</sup>	1 hour	1.31607	-	326440	462172	-	-	-	-	-	-	-
Sum of Metals (Sb) <sup>b</sup>	24 hours	0.49540	-	326440	462572	-	-	-	-	-	-	-
Sum of Metals (Sb) <sup>b</sup>	1 year	0.09818	-	326440	462472	-	-	-	-	-	-	-
Sum of Metals (As) <sup>c</sup>	1 hour	0.13161	-	326440	462172	-	-	-	-	-	-	-
Sum of Metals (As) <sup>c</sup>	24 hours	0.04954	-	326440	462572	-	-	-	-	-	-	-
Sum of Metals (As) <sup>c</sup>	1 year	0.00982	-	326440	462472	-	-	-	-	-	-	-
Sum of Metals (Tl) <sup>d</sup>	1 hour	0.13161	-	326440	462172	-	-	-	-	-	-	-
Sum of Metals (Tl) <sup>d</sup>	24 hours	0.04954	-	326440	462572	-	-	-	-	-	-	-
Sum of Metals (Tl) <sup>d</sup>	1 year	0.00982	-	326440	462472	-	-	-	-	-	-	-

<sup>a</sup> Compared with applicable standards where available.

<sup>b</sup> Sum of metals: Antimony, Chromium, Copper, Manganese, Vanadium, in, Lead, Cobalt, Nickel

<sup>c</sup> Sum of metals: Arsenic / cadmium and its compounds (expressed as As and Cd), benzo (a) pyrene, water-soluble cobalt compounds (expressed as Co), chromium (VI) compounds (expressed as Cr)

<sup>d</sup> Sum of metals: Thallium and its compounds and cadmium



479. **Recommendations.** With regard to the results of modeling, the following were recommended:

- (i) Retain the four existing ambient air quality monitoring stations as recommended by the AUSTAL2000 modeling. However, additional monitoring stations should be installed or established at the ASR2, ASR3 and ASR5 areas due to presence of residential/accommodation areas. See Figure 127. The map shows the Area Sensitive Receptor primary impact areas and location of recommended Ambient Air Quality Monitoring Stations. In cases of exceedance, these areas are likely to be affected.; and
- (ii) Validation modeling should be conducted during the starting months of normal operation using actual CEMS and stack testing results to simulate actual operation of the plant.

480. Furthermore, in order to minimize generation of air pollutants from the WTE plant and to reduce the impact to the surrounding environment, the following were also recommended:

- (i) Boilers should be regularly maintained, while structures such as the stacks and ducts should be regularly checked to avoid fugitive dusts sources and particulate accumulation;
- (ii) Control devices such as the Dry Scrubber and Baghouse should undergo regular checkup and maintenance;
- (iii) Solid wastes should have acceptance criteria in terms of waste characteristics;
- (iv) Waste should be dried to eliminate moisture, which is a precursor to incomplete combustion that results to higher particulate matter (PM) and carbon monoxide (CO) generation;
- (v) Periodic watering of roads to minimize generation and resuspension of dust particles;
- (vi) Forestation and plantation at the perimeter-buffer areas to serve as vegetation walls that can help control dispersion of air pollutants;
- (vii) Regular ambient air quality monitoring should be conducted in hot spots and impacts areas based on the results of the modeling report. Actual ambient monitoring may be treated as validation of model results; and
- (viii) Every modification and installation of new sources should be considered as additional contribution to emission of the plant. Hence, modeling updates should also be conducted to determine assimilative carrying capacity of the area based on the impacts of the new modification or installation.



Figure 127: Recommended monitoring sites.



### 3. Additional Measures to Mitigate Impacts on Ambient Air Quality During Operation Phase

481. **Offset Activities Within Thilafushi.** The government plans to stop fires on Thilafushi and start baling waste by July 2020 as interim SWM solution to stop open dumping until the WTE facility is commissioned. It is expected that once these measures are implemented the air quality at the sampling locations will improve. The rehabilitation of the existing dumpsite will have the end view of shutting down the operation of the dumpsite. This activity will serve as the biggest offset to substantially reduce the impact of the WTE Plant operation to ambient air quality. Monitoring the benefits of this offset will continue throughout the operation phase and included in the environmental monitoring plan developed in this EIA report.

482. **Use of cleaner fuels or technologies.** The DBO Contract provides performance guarantees that will ensure use of cleaner fuels and technologies that have already been proven in other countries. These performance guarantees will ensure that the WTE plant will comply with the emission standards.

### 4. Water Pollution Due to Cooling Water and Brine

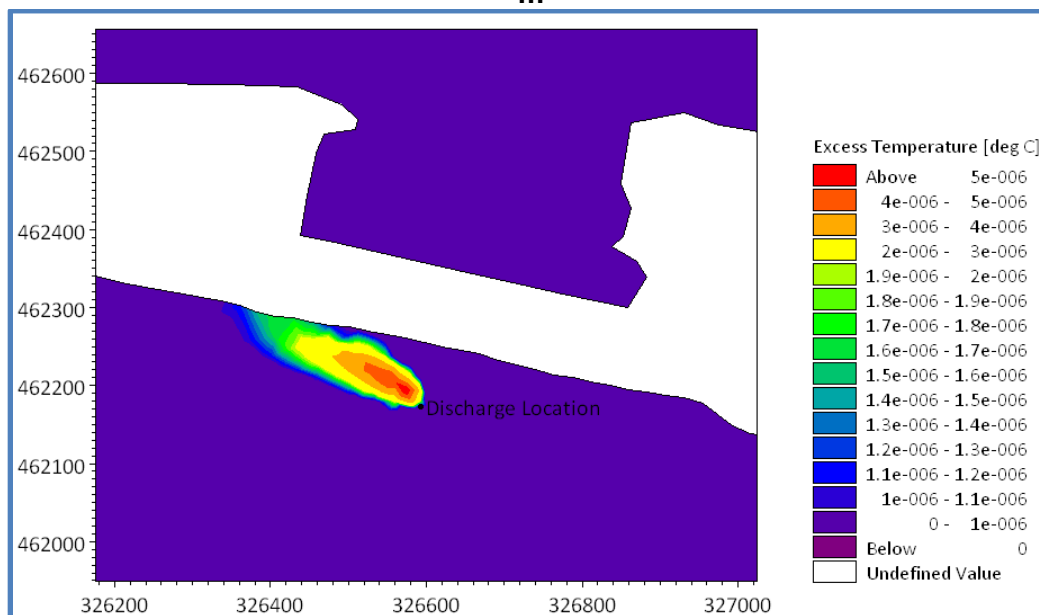
483. In Section IV (Alternatives Analysis), three alternative locations have been assessed on where the cooling water discharge pipe could be positioned at the 500-meter coastal stretch south of the project site. These alternative locations were tagged as M8, M9, and M10 in

**Figure 11.** As initial step in the analysis, underwater marine survey was undertaken to profile the characteristics of the coral reef and extent of marine life, including pelagic species, along this stretch at various depths. Results show that profiles at these three tagged locations are identical and reveal the very few (or none at all) marine species at depth of less than 10m. The results further reveal that no significant marine life such as live corals, fishes or other pelagic organisms can be found at greater depths. This finding is particularly valid at the depth of more than 20

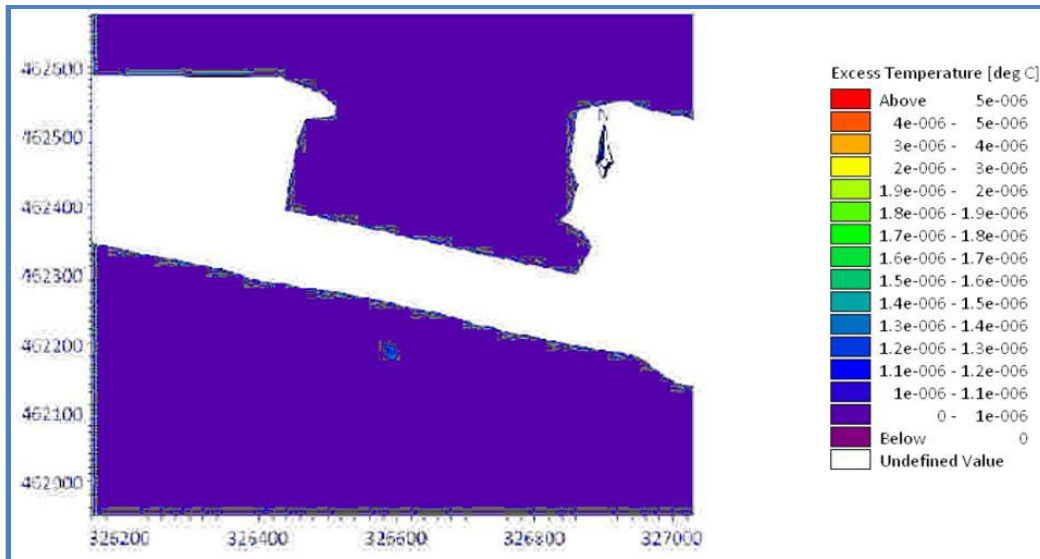
meters, wherein the seabed/reef wall is characterized by large expanse of rocks with rubbles scattered and no evidence of live corals anymore. Thus, the selection of the best option from among the three alternatives has been based on the slope of the reef instead. From engineering point of view, the discharge pipe can be anchored best in a gradually sloping seabed. Visual observation during the underwater survey suggest that the M8 section has the best slope to position the discharge pipe.

484. In the same alternatives analysis, the next step undertaken was to determine at which depth the outfall should be positioned at the M8 section. A hot water dispersion modeling was carried out to assess the rate of heat dissipation of hot water at various depths (10 m, 20 m, and 30 m). It was found that the deepest position at 30m has the least potential impact on the marine environment. At this depth, the dissipation of heat from the cooling water is fastest. Even with the worst-case scenario (high influence scenario) at the depth of 10m, the excess temperature will already reduce to less than 1°C within few meters (in the near-field modeling) and to  $5 \times 10^{-6}$  °C within the 90m range (in the far-field modeling). According to the model results, this excess temperature is very low and negligible in coastal environment. Comparison of the heat dissipation under the worst case (high influence) scenario and best-case scenario is illustrated below. Figure 128 depicts one example of modeled heat dissipation scenario at 10 m depth, while Figure 129 depicts one example of modeled heat dissipation scenario at 30 m depth.

**Figure 128: Thermal Dispersion towards West at Scenario with 10 degrees at a depth 10 m**



**Figure 129: Thermal Dispersion towards West at Scenario with 10 degrees at a depth 30 m**



485. However, as a precautionary measure, the outfall is recommended to be positioned at the depth of 30 m, which is the best-case scenario in the model. The location is much more defensible because at this depth, no marine life exists based on the underwater survey. The cooling water discharge will not pose any impact at this region.

486. The brine that will be generated from the desalination process will need to be disposed or discharged back to the sea. However, doing so may impact marine life at the discharge point. As a measure, the brine will be discharged through the cooling water discharge line. The volume of brine that will be generated from the desalination process is expected to be small compared to the volume of cooling water that will be used in the condenser cooling process. Hence, no significant change in the salinity of the cooling water is expected. This measure shall be integrated in the detailed design of the WTE plant by the DBO contractor.

## 5. Air, Water, and Land Pollution Due to Disposal of Ash and Other Residuals

487. The handling, treatment and disposal of ash and other residuals from the operation of the WTE plant will follow EHS Guidelines on Waste Management Facilities. The DBO Contractor will be required to integrate in the detailed design the following measures:

- (i) Design the furnace to, as far as possible, physically retain the waste within the combustion chamber (e.g. narrow grate bar spacing for grates, rotary or static kilns for appreciably liquid wastes), and use a waste throughput rate that provides sufficient agitation and residence time of the waste in the furnace at sufficiently high temperatures, including any ash burn-out areas, in order to achieve a total organic carbon (TOC) value in the ash residues of below 3 weight percent and typically between 1 and 2 weight percent.
- (ii) Manage bottom ash separately from fly ash and other flue gas treatment residues to avoid contamination of the bottom ash for its potential recovery;
- (iii) Separate remaining ferrous and non-ferrous metals from bottom ash as far as practicably and economically viable, for their recovery;
- (iv) Treat bottom ash on or off-site (e.g., by screening and crushing) to the extent that is required to meet the specifications set for its use or at the receiving treatment or

- disposal site (e.g., to achieve a leaching level for metals and salts that is in compliance with the local environmental conditions at the place of use);
- (v) Bottom ash and residuals should be managed based on their classification as hazardous or non-hazardous materials. Hazardous ash should be managed and disposed of as hazardous waste. Non-hazardous ash may
  - (vi) be disposed of in an MSW landfill or considered for recycling in construction materials.<sup>42</sup>

## **6. Water Pollution Due to Discharge of Landfill Leachate**

488. The leachate generated from the WTE Plant will be the leachate coming from the landfill cells. In order to avoid discharging untreated leachate to the marine environment, the construction of the landfill shall follow the following requirements that are included in the bidding documents:

- (i) The landfill shall accommodate residues from the incineration facility (APC residues and non-marketable bottom ash).
- (ii) The base liner system shall be of impermeable nature and shall prevent any leachate seepage towards the subsoil beneath the base liner system.

## **7. Socio-economic impacts**

489. The project is expected to generate employment opportunities for waste collection, transportation, operation of the machineries and plants, and administrative support.

## **8. Community and Occupational health and safety**

490. Operation of the WTE plant and its components poses significant occupation health and safety risks. To reduce the risks, contractors will be required to appoint health and safety officers for each site and to ensure regular briefing of the construction workforce on health and safety issues. The contractor shall establish its health and safety plans to be adopted at each site following international best practices and the World Bank EHS guidelines on construction and decommissioning activities.

491. The machineries and plants require different chemicals and hazardous substances for operation. There is invariably a risk when such chemicals are handled. Although the WTE Plant is located away from residents, there is a considerable safety risk to workers at the plant and also surrounding environment in the event of any leak or spill.

492. Similar to impacts and measures during construction phase, the DBO Contractor shall integrate during detailed design applicable international good practices on community and occupation health and safety in its operation of the WTE, such those included in World Bank EHS Guidelines on Waste Management Facilities (footnote 37). The most significant occupational health and safety impacts typically associated with workers at waste management facilities occur during the operational phase and include accidents and injuries, chemical exposure, and exposure to pathogens and vectors. Minimum requirements shall be the following:

493. **Accidents and Injuries.** Physical hazards encountered at waste management facilities are similar to those at other large industrial projects. Solid waste workers are particularly prone to accidents involving trucks and other moving equipment, so traffic management systems and traffic

---

<sup>42</sup> EPA (<http://www.epa.gov>)

controllers are recommended. Accidents include slides from unstable disposal piles, cave-ins of disposal site surfaces, fires, explosions, being caught in processing equipment, and being run over by mobile equipment. Other injuries occur from heavy lifting, contact with sharps, chemical burns, and infectious agents. Smoke, dusts, and bioaerosols can lead to injuries to eyes, ears, and respiratory systems.<sup>43</sup> In addition to other standard measures adopted in most industrial facility operations, the applicable procedures following international best practices are recommended to prevent, minimize, and control accidents and injuries at the WTE plant and its associated facilities.

494. **Chemical Exposure.** Chemical hazards encountered at waste management facilities are similar to those at other large industrial facilities, such as toxic and asphyxiating gases, and are addressed in the General EHS Guidelines. However, the full composition of wastes and their potential hazards is often unknown. Even municipal solid waste (MSW) often contains hazardous chemicals, such as heavy metals from discarded batteries, lighting fixtures, paints, and inks. The following procedures are recommended, whichever are applicable, to prevent, minimize, and control chemical exposure at the WTE plant:

- (i) Control and characterize incoming waste (see waste receipt, unloading, processing and storage);
- (ii) Provide adequate personnel facilities, including washing areas and areas to change clothes before and after work;
- (iii) Ventilate enclosed processing areas (e.g., dust in waste size reduction areas, VOCs driven off by high temperatures during composting);
- (iv) Monitor breathing zone air quality in work areas at processing, transfer and disposal facilities. Direct-reading instruments that measure methane and oxygen deficiency are of primary importance; these include combustible gas indicators, flame ionization detectors, and oxygen meters. At waste treatment/disposal facilities, volatile organics should also be analyzed in the biodegradation gases being collected and/or vented. In waste handling, sorting, and composting facilities, monitoring for organic dust is needed;
- (v) Prohibit eating, smoking, and drinking except in designated areas; and
- (vi) Provide air filtered and air-conditioned cabs for heavy mobile equipment used at landfills as necessary.

495. **Pathogens and Vectors.** Workers can be exposed to pathogens contained in manure and animal excreta found in MSW from the disposal of sludge, carcasses, diapers, and yard trimmings containing domestic animal waste. Uncontrolled dumping of MSW attracts rats, flies, and other insects that can transmit diseases. Processing of MSW can also generate bioaerosols, suspensions of particles in the air consisting partially or wholly of microorganisms, such as bacteria, viruses, molds, and fungi. These microorganisms can remain suspended in the air for long periods of time, retaining viability or infectivity. Workers may also be exposed to endotoxins, which are produced within a microorganism and released upon destruction of the cell and which can be carried by airborne dust particles. The following measures are recommended to prevent, minimize, and control pathogens and vectors at the WTE plant:

- (i) Provide and require use of suitable personal protective clothing and equipment;
- (ii) Provide worker immunization and health monitoring (e.g., for Hepatitis B and tetanus);
- (iii) Maintain good housekeeping in waste processing and storage areas;

---

<sup>43</sup> Refer to Cointreau. S. (2006) for additional information.

- (iv) Use automatic (non-manual) waste handling methods if practical;
- (v) Clean and wash with disinfectant the cabins of heavy mobile equipment used at regular intervals;
- (vi) Grade the area properly to prevent ponding (to minimize insect breeding areas);
- (vii) Use integrated pest-control approaches to control vermin levels, treating infested areas, such as exposed faces and flanks with insecticide, if necessary;
- (viii) Provide and require use of dust masks or respirators under dry and dusty conditions. Charcoal-filled respirators also reduce odor perception;
- (ix) Provide prompt medical attention for cuts and bruises. Cover open wounds to prevent contact with the incoming loads or feedstock; and
- (x) Fully enclose the waste management site with fencing so that no livestock or wildlife is able to come in contact with the waste, which contains significant potential to enable the spread of livestock and zoonotic disease, as well as spillover disease to wildlife. Provide daily cover of wastes to minimize the attraction to birds, which can become infected with avian influenza and other bird diseases that can then be carried off-site.

**496. General Occupational and Environmental Health Issues Associated with Waste Scavenging.** The presence of informal sector workers laboring in municipal or mixed waste disposal sites in search of commercially valuable materials is a common place occurrence in developing countries. The causes and dynamics are the result of complex social, cultural, labor, and economic factors that are clearly outside of the scope of this guidance document. However, the following principles, if applicable, should be considered in managing the occupational, health, and safety risks at the WTE site:

- (i) Waste scavenging should not be allowed under any circumstances in hazardous and non-hazardous industrial waste management facilities;
- (ii) Facilities dedicated to the management of MSW should work with government entities in the development of simple infrastructure that can allow for the sorting of waste, helping groups of scavengers form cooperatives or other forms of micro-enterprises, or formally contracting them to provide this function. The outright displacement of scavenging workers as an occupational health and safety management strategy, without the provision of viable alternatives, should be avoided;
- (iii) Operators of existing facilities with scavenging workers should exercise commercially viable means of formalizing their work through the creation of management programs that include:
  - (a) Allowing only registered adults on the site, excluding children and domestic animals. Striving to provide alternatives to access to childcare and education to children;
  - (b) Providing protective gear, such as shoes, face masks, and gloves;
  - (c) Arranging the disposal layout and provide sorting facilities to improve access to recyclables while reducing their contact with other operations, thus minimizing potential hazards;
  - (d) Providing water supply for washing and areas for changing clothes;
  - (e) Implementing education campaigns regarding sanitation, hygiene, and care of domestic animals;
  - (f) Providing a worker health surveillance program including regular vaccination and health examinations.

497. **Physical, Chemical, and Biological Hazards.** Visitors and trespassers at waste management facilities may be subject to many of the hazards described for site workers. In particular, waste pickers, looking for recyclable materials and food scraps for animal feeding, often work informally at waste transfer and disposal sites, especially MSW facilities, typically living adjacent to the site in poor housing conditions, with minimal basic infrastructure for clean water and sanitation. Waste pickers may be encounter numerous risks, including contact with human fecal matter, paper that may have become saturated with toxic materials, bottles with chemical residues, metal containers with residue pesticides and solvents, needles and bandages (containing pathogenic organisms) from hospitals, and batteries containing heavy metals. Exhaust fumes of waste collection trucks traveling to and from disposal sites, dust from disposal operations, and open burning of waste all contribute to potential occupational health problems.<sup>44</sup> Recommended measures to prevent, minimize, and control physical, chemical, and biological hazards to the community around the WTE site include:

- (i) Restrict access to waste management facilities by implementing security procedures, such as:
  - (a) Perimeter fencing of adequate height and suitable material, e.g. chain link, stock proof palisade;
  - (b) Lockable site access gate and buildings; o Security cameras at key access points linked to recording equipment and remote access CCTV, where required;
  - (c) Security alarms fitted to buildings and storage areas; o Review of site security measures annually or whenever a security breach is reported
  - (d) Use of a site visitor register; o Immediate repair of fencing/access points if damaged; and
  - (e) Lighting of site during night time where necessary. As this may cause light nuisance to neighbors, the lighting installations should be selected to minimize ambient light pollution.

498. **Workers Accommodation During Operations.** The accommodation of workers shall be established following international best practices to ensure welfare of workers is protected.<sup>45</sup> The DBO Contractor shall consider the following requirements in building these camps and accommodation facilities at the site, if any.

- (i) The temporary campsite location should:
  - (a) Be free from any risk of flooding.
  - (b) Be sited a reasonable distance and have clear physical separation from any construction work, equipment and/or machinery.
  - (c) Provide clear separation between the camp and construction area through such means as a footpath, fence, etc.

<sup>44</sup> Sandra Cointreau, The World Bank Group, Occupational and Environmental Health Issues of Solid Waste Management Special Emphasis on Middle- and Lower-Income Countries, Urban Papers UP-2, July 2006.

<sup>45</sup> From the draft Construction Code of Practice developed for urban development projects in Kathmandu, Nepal. This COP was developed with reference to the following: "Workers' accommodation: processes and standards: A guidance note by IFC and EBRD", IFC and EBRD, 2009 [https://www.ebrd.com/downloads/about/sustainability/Workers\\_accomodation.pdf](https://www.ebrd.com/downloads/about/sustainability/Workers_accomodation.pdf); and "Malaysian standards of temporary construction site workers' amenities and accommodation – code of practice. (MS 2593, 2015) [http://www.sirim.my/srmc/documents/Aug-Sept-2014/12D024R0\\_PC.pdf](http://www.sirim.my/srmc/documents/Aug-Sept-2014/12D024R0_PC.pdf)



- (d) Where possible, be sited outside the boundary of the construction zone.
- (ii) The site design should ensure:
- (a) Adequate space to accommodate the number of workers throughout the project period, for accommodation, meals, toilets, bathing, etc.
  - (b) Considerations for needs of all types of workers: e.g. women, local laborers or travelers, etc.
  - (c) Adequate drainage is provided to prevent any stagnant water which can attract mosquitos and vermin and spread disease among workers,
  - (d) Buildings are structurally sound and can withstand wind and rain.
  - (e) Ensure that the worker camp area will have adequate ground surfacing (e.g. gravel, wood sheeting, grass) such that residents may move freely between buildings in their off time without walking through mud and water.
  - (f) Designated area for small fires during colder months, located a safe distance from buildings and any flammable materials.
- (iii) The workers' accommodation should comply with the following requirements:

#### **Dimensions and Design**

- (a) The height of room shall not be less than 2.4 meters.
- (b) The sleeping area or resting area shall not be less than 3 m<sup>2</sup> per person.
- (c) Separate bed for each worker provided, with minimum of 1m space between each bed.
- (d) Separate sleeping areas are provided for men and women, except in family rooms if needed.
- (e) Sleeping area should be separate from cooking/canteen areas, and far enough distance from toilets to avoid odors.
- (f) Where possible, prefab-type structures could be considered.

#### **Light and Air**

- (a) Both natural and artificial lighting are provided and maintained in living facilities. It is best practice that the window area represents not less than 5% to 10% of the floor area. Emergency lighting is provided.
- (b) For cold weather months, accommodation must be such that the temperature is kept at a level of around 20 degrees Celsius notwithstanding the need for adequate ventilation.
- (c) In warmer months, adequate ventilation (either cross-ventilation and/or fans) is provided.

#### **Materials**

- (a) Roofing materials must be such that the structure can withstand high winds without risk of collapse and be leak-free during rainy season.
- (b) Flooring material should be easily cleanable and free of bare nails or other sharp objects.

#### **Provisions/furnishing**

- (a) Each worker is provided with a comfortable mattress, pillow, cover and clean bedding.
  - (b) Double or triple-deck bunk beds are prohibited. Double deck bunks may be used in special circumstances but must be approved by the Engineer.
  - (c) Each resident is provided facilities for the storage of personal belongings, such as a locker or shelving unit.
  - (d) Every resident is provided with adequate furniture such as a table, a chair, a mirror and a bedside light (small solar lights may be a good option). These may be shared among several workers.
  - (e) Separate storage provided for work boots and PPE. Drying/airing areas may need to be provided for PPE depending on conditions.
  - (f) Mosquito nets are provided in areas where mosquitos are present and/or at the request of workers.
  - (g) Rubbish bin with cover provided in each room and emptied regularly.
  - (h) Electrical outlets provided for charging mobile phones, radio, etc. Ensure that electrical wiring is done properly and presents no risk of electrical fire.
  - (i) All doors and windows should be lockable and be provided with mosquito screens.
- (iv) The workers kitchen area should comply with the following requirements:
- (a) The minimum area of kitchen should be not less than 4.5 m<sup>2</sup> and the minimum width should be more than 1.5 meters.
  - (b) Adequate height of kitchen should be not less than 2.25 meters.
  - (c) Provide where clean drinking water is always available – ensure that any open water tanks are covered.
  - (d) Kitchens are provided with facilities to maintain adequate personal hygiene including a sufficient number of washbasins designated for cleaning hands with clean water and materials for hygienic hand-drying.
  - (e) In order to enable easy cleaning, it is good practice that cooking stoves are not sealed against a wall, and benches and fixtures are not built into the floor.
  - (f) Design should consider if the kitchen within the camp will be used to service all workers for all meals (e.g. meals prepared for day laborers as well as residents) or will be limited to self-preparation of meals by residents.
  - (g) Wall surfaces adjacent to cooking areas are made of fire-resistant materials.
  - (h) Food preparation tables are equipped with a smooth, durable, easily cleanable, non-corrosive surface made of non-toxic materials.
  - (i) All cupboards and other fixtures have a smooth, durable and washable surface.
  - (j) All kitchen floors, ceiling and wall surfaces adjacent to or above food preparation and cooking areas are built using durable, non-absorbent, easily cleanable, non-toxic materials.
  - (k) Cooking gas canisters provided
  - (l) Fire extinguisher provided outside of cooking area.
  - (m) Rubbish bin(s) provided with cover
  - (n) Adequate facilities for cleaning, disinfecting and storage of cooking utensils and equipment are provided.
- (v) The workers toilets should comply with the following requirements:

- (a) Toilets should be located within same general area as accommodation, but at least 30 meters away from sleeping area/kitchen. Should not be more than 60m away.
  - (b) Toilets should be located at least 30 meters away from any water wells.
  - (c) An adequate number of toilets should be provided to workers. Standards range from 1 unit per 15 persons to 1 unit per 6 persons.
  - (d) Toilet rooms shall be located so as to be accessible without any individual having to pass through any sleeping room
  - (e) Toilet dimensions should be at least 1.5 m × 0.75 m (minimum width)
  - (f) Toilet facilities should be installed so as to prevent any odors reaching dining facilities or sleeping areas.
  - (g) Separate facilities provided for men and women.
  - (h) An adequate number of handwash facilities is provided to workers. Standards range from 1 unit per 15 persons to 1 unit per 6 workers. Handwash facilities should consist of a tap and a basin, soap and hygienic means of drying hands.
  - (i) Toilets should be constructed such that they are structurally sound during high winds and free from leaks during rains.
  - (j) Every toilet should be provided with natural lighting and natural ventilation by means of  $\geq 1$  openings, providing a total area of  $>0.2 \text{ m}^2$  per toilet. Such openings shall be capable of allowing a free, uninterrupted passage of air.
  - (k) In addition, all toilet rooms should be well-lit, with natural lighting and artificial lights at night.
  - (l) Ensure no discharge of toilets and showers that will contaminate water sources or common areas
  - (m) Sanitary and toilet facilities are designed to provide workers with adequate privacy, including ceiling to floor partitions and lockable doors
  - (n) Ensure toilets have rubbish bin in each cubicle
- (vi) The shower and washing facilities should comply with the following requirements:
- (a) An adequate number of shower facilities is provided to workers. Standards range from 1 unit per 15 persons to 1 unit per 6 persons.
  - (b) Shower/bathing facilities are provided with an adequate supply of clean water.
  - (c) Separate facilities for men and women.
  - (d) The flooring for shower facilities should be of hard washable materials, damp-proof and properly drained.
  - (e) Suitable light, ventilation and soap should be provided.
  - (f) Adequate space and hooks must be provided for hanging clothes/towels while bathing.
  - (g) Area for washing/drying clothes provided, including washbasin, soap and drying lines. Either piped water to the basin or standpipe for filling basins should be within close distance.
  - (h) Ensure area drains well and doesn't create a muddy environment.
- (vii) Optional Amenities and Other Good Practices that should be followed as applicable:
- (a) Paint the camp buildings to present a tidy and satisfactory appearance – this will help encourage workers to keep their camp in good condition.

- (b) Provide signage in kitchen area, canteen, toilets, and other common areas to encourage good hygiene practices, cleanliness of kitchen and personal spaces, worker conduct, worker responsibilities, safety evacuation plan, etc.
- (c) Involve laborers in design of the camp, e.g. to get their inputs on siting of buildings, and any specific needs of women.

## **9. Residual Impacts**

499. The residual wastes from the waste incineration are bottom ash, slag and the residues from flue ash. Bottom ash and slag is a valuable fraction which may potentially be used for many purposes such as covering material for landfill, ballast layer or reinforcement layer in road construction or filler/aggregate for construction blocks. A study was commissioned under the project on the potential use of incinerator bottom ash for commercial purposes. Conclusion on the study says that the incinerator bottom ash has the potential for use in the construction industry. A copy of the complete report is in Appendix 6.

500. Under any circumstances that these options are not feasible, the sanitary landfill will be able to accommodate the residual wastes. The hazardous residues from the flue gas cleaning (fly ash) will be conditioned safely in sealed bags and disposed in a controlled way at the sanitary landfill. Similarly, the fly ash collected from flue gas cleaning is cooled down, stored in big bags and disposed in the same sanitary landfill.

## **10. Cumulative Impacts**

501. As of the assessment, there are no other similar planned projects that will be established or put up in Thilafushi or adjacent islands. Therefore, the WTE plant will not contribute to any cumulative negative impact with other sources of similar impacts in Thilafushi, and/or any existing project or condition, and/or other project-related developments that are realistically defined at the time the assessment. The future plan of the project to expand by 50% will not have any cumulative negative effects because it will instead address the potential environmental impact of increased solid waste generation in the future. Nevertheless, a strategic environmental assessment will be undertaken in the future to evaluate the cumulative and other potential environmental impacts of future SWM projects in Thilafushi, and Maldives in general, including the planned expansion of the WTE plant by 50%.

## **11. Greenhouse Gas Emissions**

502. The operation of the WTE Plant will be a potential source of greenhouse gas emissions due to the inherent combustion processes involved in plant operations. This GHG emission poses a potential transboundary impact on endangered species and habitats. However, comparing with the current practice of landfilling solid wastes in Maldives, the incineration process will greatly reduce the volume of the waste (in the form of residual ash) that need to be disposed in sanitary landfills. Therefore, the production of greenhouse gases due to landfilling will be reduced. The WTE plant will generate electricity for the industries on Thilafushi, replacing their dependence on fossil fuel use for power generation. Summing these all leads to an overall reduction of greenhouse gas emission by the Maldives. A complete accounting and analysis of GHG emission by the WTE Project resulted to GHG emission reduction of approximately 40,000 tCO<sub>2</sub>e/year, which is the average annual reduction across the project life cycle.

Table **47** shows the summary of estimated GHG emission reduction from the WTE Plant. The complete report on the GHG emission inventory and analysis is in Appendix 8.

**Table 47: Estimated GHG Emission Reduction from the WTE Plant**

Year	Reference emissions		Project emissions		Emission reductions		Accumulated GHG ERs	
	GHG total	CO2 only	GHG total	CO2 only	GHG total	CO2 only	GHG total	CO2 only
Unit	tCO2e	tCO2	tCO2e	tCO2	tCO2e	tCO2	tCO2e	tCO2
2025	36,380.2	36,380.2	38,941.4	36,428.2	-2,561.2	-48.0	-2,561.2	-48.0
2026	61,931.4	54,930.2	43,075.9	40,276.0	18,855.5	14,654.2	16,294.3	14,606.2
2027	69,230.3	56,260.8	43,959.7	41,098.5	25,270.6	15,162.3	41,564.9	29,768.5
2028	75,150.0	57,518.6	44,799.4	41,880.0	30,350.6	15,638.6	71,915.5	45,407.1
2029	78,794.1	57,414.2	44,742.2	41,826.8	34,051.9	15,587.4	105,967.4	60,994.5
2030	81,741.5	57,425.0	44,757.8	41,841.3	36,983.7	15,583.7	142,951.1	76,578.2
2031	84,114.3	57,426.5	44,764.5	41,847.5	39,349.8	15,579.0	182,300.9	92,157.2
2032	86,078.3	57,430.1	44,768.9	41,851.6	41,309.4	15,578.5	223,610.3	107,735.7
2033	87,740.1	57,435.1	44,770.5	41,853.1	42,969.6	15,582.0	266,579.9	123,317.7
2034	89,173.8	57,440.9	44,769.2	41,851.9	44,404.6	15,589.0	310,984.5	138,906.7
2035	90,432.4	57,448.1	44,764.3	41,847.3	45,668.1	15,600.8	356,652.6	154,507.5
2036	91,552.3	57,456.0	44,755.9	41,839.5	46,796.4	15,616.5	403,449.0	170,124.0
2037	92,560.9	57,465.4	44,743.7	41,828.2	47,817.2	15,637.2	451,266.2	185,761.2
2038	93,477.5	57,476.2	44,727.6	41,813.2	48,749.9	15,663.0	500,016.1	201,424.2
2039	94,306.5	57,478.3	44,581.7	41,677.4	49,724.8	15,800.9	549,740.9	217,225.1
2040	95,071.9	57,509.3	44,456.4	41,560.8	50,615.5	15,948.5	600,356.4	233,173.6
2041	95,763.1	57,538.8	44,331.6	41,444.6	51,431.5	16,094.2	651,787.9	249,267.8
2042	96,392.8	57,569.0	44,207.0	41,328.7	52,185.8	16,240.3	703,973.7	265,508.1
**2043	96,392.8	57,569.0	44,207.0	41,328.7	52,185.8	16,240.3	756,159.5	281,748.4
**2044	96,392.8	57,569.0	44,207.0	41,328.7	52,185.8	16,240.3	808,345.3	297,988.7
Total	1,692,677.0	1,124,740.7	884,331.7	826,752.0	808,345	297,989		

**Table 48: Summary of Impacts Due to Operation of the Project.**

Potential Impact	Assessment
Water pollution and impacts on marine environment	Long-term, Negative, Significant
Air pollution and noise	Long-term, Negative, Significant
Impacts on biodiversity	Long-term, Negative, Significant
Socio-economic impacts	Long-term, Positive, Significant
Occupational health and safety	Long-term, Negative, Significant
Residual wastes	Long-term, Negative, Significant
Greenhouse gas emission	Long-term, Positive, Significant

## VII. INFORMATION DISCLOSURE, CONSULTATION AND PARTICIPATION

503. This section provides the outcomes of the stakeholder consultations undertaken during the project preparatory stage. The objectives of the consultations are to ensure that project information is accurately and properly disseminated to all stakeholders, and to engage these stakeholders to participate in the environmental assessment process. The consultation process is also a way to ensure that all issues from the stakeholders about the project are considered in the environmental management planning and ultimately addressed in the environmental management plan. Stakeholder consultations also provide valuable guidance and direction to safeguard the interests of the stakeholders, developers and the environment. This section outlines the consultations that were carried out with stakeholders and the community.

504. The approach for stakeholder consultations was to have an interaction with key stakeholders on issues that matter to them and those that are of material value for the project.

The stakeholders were grouped into internal, external and others including private and civil society.

505. The internal stakeholders comprise the project proponent, Ministry of Environment, project management unit (PMU) and the Maldives EPA. The external stakeholders include other government regulators and service providers. Other stakeholders include NGOs and the civil society. Interviews with relevant persons from these groups were undertaken. During interviews, discussions focused on the perceptions on the project, the selected locations, environmental or social impacts when implementing the project, energy use and efficiency, harbor and road use, and other aspects. The consultations explored on issues with locations, concerns and suggestions for improving project implementation.

506. In 2017, the first round of stakeholder consultations commenced and undertaken by PMU. The initial stakeholders consulted were the community people at Thilafushi, the diving community in Maldives, and Bluepeace Maldives, which is an NGO active in the environment sector. Table 49 below summarizes the issues and views gathered during these consultation activities.

**Table 49: Summary of Consultations in 2017**

<b>Date of Consultation</b>	<b>Organization / Group Consulted</b>	<b>Issues / Views on the Project</b>
July 2017	<p>Community Living in Thilafushi</p> <p>The people living on Thilafushi were consulted during July 2017 as part of the EIA work. The method included selecting people randomly who live on the island and asking them a set of questions regarding the project and their experience on the island and how they expect the project would affect them. The following are the major outcomes of the interviews with the residents of the island.</p>	<ul style="list-style-type: none"> <li>• Everyone surveyed in the island noted, that waste management is a big issue at the island. They do not think that waste management, treatment and disposal is being properly carried out by the authority.</li> <li>• Major issues the people noted were the smoke and the mosquitos. Some days, the smoke becomes so thick it becomes difficult for them to live. Similarly, mosquitos become a big issue during the rainy season.</li> <li>• Most of the people surveyed noted that the Thilafushi is seen as a dump site. Hence the overall hygienic condition of the island is low.</li> <li>• Some of residents noted that the area allocated for the waste management is small and the waste has become piled into mountains on the islands. Some noted that the waste mountains are growing rapidly, and they are do not know what will happen in the future</li> <li>• The island has a water supply network and desalinated freshwater is available on the island. However, the island does not have a proper sewerage network.</li> <li>• The roads on the islands are poorly maintained and the condition gets worse after each rainy season. Hence the transportation within in the islands is difficult.</li> <li>• Everyone noted that Thilafushi is connected to Malé via a regular ferry which starts early morning but stops early evening. However, the island is an isolated and not much recreation activity is available on the island.</li> </ul>
24 October 2017	Bluepeace Maldives	<ul style="list-style-type: none"> <li>• Bluepeace has been advocating to improve conditions on Thilafushi for a long time. Bluepeace has been voicing the view</li> </ul>

Date of Consultation	Organization / Group Consulted	Issues / Views on the Project
	<p>Bluepeace Maldives is an NGO active in the area of environment and development. Bluepeace was consulted on 24th October 2017 at Water Solutions. Following are the main outcomes and summary of the discussion of the stakeholder meeting.</p>	<p>that Thilafushi is fast becoming a serious ecological and health problem in the Maldives and something drastic needs to be done to improve the waste management practices at Thilafushi.</p> <ul style="list-style-type: none"> <li>• People could find garbage floating inside and outside of the lagoon during high tides on a daily basis. The floating waste becomes a navigation hazard.</li> <li>• Bluepeace strongly feels the solution to the issue of Waste can only be addressed within a National Framework for Solid Waste Management in the Maldives. There are a number of studies by different organizations on Solid Waste Disposal for the Maldives, including hazardous waste. Most of the studies have gathered dust on bookshelves.</li> <li>• The proposed project is important to develop the regional waste management facility at Thilafushi and in addition is needed to treat the existing waste mountain at the island.</li> <li>• Bluepeace strongly feels there is a need to undertake a detailed study on the environmental impact of landfilling which had been carried out at Thilafushi using waste collected.</li> </ul>
	<p>Diving Community of Maldives</p> <p>The diving community is one group of groups who have raised various concerns about waste management issues from Thilafushi for many years but have not been able to achieve any meaningful outcome due to the nature of the issue. Divers have always been exploring the reef around Thilafushi and other reefs in the nearby regions and considers that Thilafushi reef is also among the good diving</p>	<ul style="list-style-type: none"> <li>• According to Raazee, who is the Operations Manager of Best Dives managing many dive centers including the dive center in Centra Rasfushi located in the island of Giraavaru and Jumeriah Vittaveli, a lot of change that has been taking place at Lions Head over the years. This change is considered to be partly attributed to the waste management that began in Thilafushi. A reduced number of fishes has been observed, most importantly sharks. However, the shark population according to Raazee declined because of uncontrolled shark fishing throughout the Maldives and not necessarily because of Thilafushi. This site is now no longer considered as a protected site by many divers and most resorts avoid this site due to the thick smoke from Thilafushi and also due to the fact that most visitors are also aware of the famous garbage island.</li> <li>• The name, Lions Head was given to the dive site due to the presence of a large rock outcrop from the reef which resembles the head of a lion. The protected dive site popularly known as “Lions Head” was one of the most dived sites in the region and famous for shark watching. In the early 1980’s this was one of the top shark points in North Malé region. Dive schools from around the nearby resorts use this dive site on their daily dive roster.</li> <li>• Another industry expert, Hussain Rifau who has more than 20 years of diving in liveboards, indicated that the decline in fish population cannot be attributed to Thilafushi alone as no proper studies have been done to verify this. It is not proven but may likely be a cause. Nevertheless, liveboards do not dive here and one reason is that they do not want to give the impression to high paying divers that their dive site is contaminated with garbage.</li> <li>• The creation of Thilafushi has not necessarily increased garbage in the house reef. As it happens that the Thilafushi reef is open</li> </ul>



Date of Consultation	Organization / Group Consulted	Issues / Views on the Project
	sites in the region. Various experienced divers representing dive schools, veterans of diving and people who have vast knowledge of the changes that took place in the nature of diving in the region were consulted and the following are some of the outcomes of the discussions and general comments made by these stakeholders.	<p>to a channel, currents are very high and any floating solid waste material is quickly taken away from the house reef and this is why considering the condition of Thilafushi, the house reef is still quite appealing and does not contain a lot of garbage as one would expect. The focus is the southern side of the house reef which is exposed to the channel.</p> <ul style="list-style-type: none"> <li>• According to Adam Shareef who managed Ocean Dive Desk until 2012, Lions Head or a part of Thilafushi house reef was included in the list of dive sites during their operational period. However, with the worsening of Thilafushi island and as its waste management issues grew bigger, dives to this site were discontinued not because the dive site is not appealing, but due to the poor visible nature of Thilafushi. It became an unpractical routine to take divers who pay US \$ 45 to 60 per boat dive to be taken close to an island where large chunks of garage are visible in the island; open burning is done with smoke plumes and frequent garbage dhonis and boats bring garbage to the island. All these visible features were negative factors for divers and regardless of the contamination status of the reef, divers would not be comfortable to dive in such a place. This is the main reason why no resorts nor any dive centers operating in Malé region do not take divers to this site.</li> <li>• Despite the poor state of Thilafushi, the south-east corner of Thilafushi has a very interesting geographical formation with caves, overhangs and large gorgonians and similarly the south-west also has interesting caves and reef formation. These are features that many divers look for in a dive site.</li> </ul>

507. In 2018, a second round of consultation activities took off targeting various institutional and organizational stakeholders under the project. Table 50 below summarizes the issues and views gathered during these consultation activities.

**Table 50: Summary of Consultations in 2018**

Date of Consultation	Organization / Group Consulted	Issues / Views on the Project
20 September 2018	Ministry of Environment (MOE)	<ul style="list-style-type: none"> <li>• The project is one of the most significant projects for the Maldives as the outcome of this project would pave way for the government to address the biggest environmental issue currently faced. The success of this project is therefore essential for sustainable environmental management in the Maldives.</li> </ul>
20 September 2018	Waste Management Corporation (WAMCO)	<ul style="list-style-type: none"> <li>• As WAMCO is the operator of the waste management facilities, they are not involved in designing of any waste management project during the design stage and most of it would be undertaken by Ministry of Environment. As such, they have not been part of the decision-making process that decided the technology for the management and disposal of waste at Thilafushi.</li> </ul>
20 September 2018	Greater Malé Industrial Zone Limited (GMIZ)	<ul style="list-style-type: none"> <li>• GMIZ indicated that they are working on a new master plan for Thilafushi and a ring road is planned south of the proposed landfill site.</li> </ul>

Date of Consultation	Organization / Group Consulted	Issues / Views on the Project
		<ul style="list-style-type: none"> <li>• GMIZ indicated that they are considering making a channel on the southern side of the island to allow flushing in the bay area of Thilafushi. No detail of the concept for this development has been prepared regarding this project.</li> <li>• GMIZ enquired whether the traffic of landing crafts would increase in the future for the transportation of waste from project area. It was explained that the landing craft movement would reduce as the collection of waste and transportation would be carried out in an organized schedule. Hence the operationalization of the Regional Waste Management Facility at Thilafushi for Project area at Thilafushi would not create additional vessel movements inside the Thilafushi lagoon.</li> </ul>
20 September 2018	Ministry of National Planning and Infrastructure (MPNI)	<ul style="list-style-type: none"> <li>• MPNI indicated that the most important aspect of this project is to ensure that the Regional Waste Management Facility does not interfere with the Greater Malé Connectivity Project (GMCP). GMCP is a vision by the government to connect Thilafushi to Malé via Gulhifalhu and Villingili. This project thus aims to connect the greater Malé region through a bridge connection that would eventually be connected to a ring road on south of Thilafushi that is been planned by GMCP. There is a plan to develop a regional port on the western side of Thilafushi and the road connections would allow connectivity to the entire greater Malé islands. This project will not interfere with the road nor its width as the road is already designed and under construction.</li> <li>• Thus, MPNI does not foresee any issues this project will have on any of their projects currently implemented as well as GMPC.</li> </ul>
20 September 2018	Parley Maldives	<ul style="list-style-type: none"> <li>• Certainly, the existing landfill at Thilafushi is the most significant source of pollution in the entire region around the central Maldives. The garbage collected on the island is washed away during high tides and during other abnormal tidal surges as Thilafushi was reclaimed to a very low level.</li> <li>• Parley has been actively involved in reducing and recycling the plastic bottles in Thilafushi. Over 36 months, they have exported 504 containers, 40 feet each.</li> <li>• Each container costs US\$ 5000 for logistics and export charges.</li> <li>• They are working with many local logistic companies in trying to reduce the plastic waste. As such, a few companies have been and are giving support to transport plastic bottles from islands to Thilafushi collection center.</li> <li>• According to Parley, their work of recycling plastics has some conflicting issues with WAMCO as they do not want third parties to get involved in waste management. WAMCO's business model was developed based on waste quantity and any reduction in waste quantity is bad for their business.</li> <li>• When parley got engaged in collecting plastics from Malé, it reduced the overall burden on WAMCO by reducing by two the daily trips to Thilafushi.</li> <li>• Parley raised the concern that the proposed Regional Waste Management Facility at Thilafushi for Project area has been designed based on incineration of waste. They expressed strong views regarding the importance of source segregation and establishment of a sorting facility at Thilafushi to sort the waste.</li> </ul>

Date of Consultation	Organization / Group Consulted	Issues / Views on the Project
		It was explained that the incineration, or WTE process ensures breakdown of any plastics introduced to the plant through high temperatures and residence time in the furnace, although it was agreed that source separation both decreases the burden on waste transfer and incineration and increases scope for re-use and re-cycling.

508. Following are the list of people who had been consulted as part of this EIA.

**Table 51: List of Institutions / Groups Consulted**

Person Consulted	Institution
Director General	Ministry of Environment
Environmental Analyst	Ministry of National Planning and Infrastructure
Assistant Project Officer	Ministry of National Planning and Infrastructure
Director General	Environmental Protection Agency
Assistant Director	Environmental Protection Agency
Assistant Project Officer	Environmental Protection Agency
Assistant Oceanographic Observer	Environmental Protection Agency
Manager of Projects Implementation	GMIZ
Deputy Manager of Operations	GMIZ
Operations Officer	WAMCO
Facilities Manager	WAMCO
Executive Director	Bluepeace
Executive Director	Parley
Environment Consultant	Water Solutions
Environment Consultant	Water Solutions
Waste Management Specialist	Kocks Consult GmbH
Dive master	Freelance dive guide
Operations Manager	Best Dives Maldives
Former shareholder	Ocean Dive Desk of Maldives

#### A. Follow-On Consultation Activities and Focus Group Discussions

509. After undertaking the targeted consultation activities in 2017–2018, several follow-on consultation activities and focus group discussions (FGDs) were held and spearheaded by PMU in 2019, with two consultation activities observed by ADB representatives. Summary of these consultation activities and FGDs is presented in Table 52 below. Compilation of all minutes of consultation activities is attached as Appendix 9.

**Table 52: Summary of Follow-on Consultations and Focus Group Discussions**

Date of Consultation	Location	No. of Participants	Description /Affiliation of Participants	Issues and Views Raised by Participants
5 August 2019	Ministry of Environment	10	Representatives of various national and local government offices	<ul style="list-style-type: none"> <li>• General dislike of the existing dumpsite.</li> <li>• Concern on the methane that would be formed in the capped waste and that it may explode.</li> </ul>

Date of Consultation	Location	No. of Participants	Description /Affiliation of Participants	Issues and Views Raised by Participants
			Representatives of various tourist resorts around Thilafushi	<ul style="list-style-type: none"> <li>• Clamor to close the existing dumpsite and undertake sampling to determine the impact of leachate.</li> <li>• Concern on impact to the food chain due to heavy metals potentially assimilated in fishes found in Thilafushi.</li> <li>• Inquiry on the basis of design of the WTE, including the life or length of operation, measures to minimize disposal of bottom ash in landfill, impact of population and economic growth, etc.</li> <li>• Clarifications on the German model used in air dispersion modeling.</li> <li>• Operations of many resorts are getting affected due to proliferation of flies and smokes from the existing dumpsite.</li> <li>• Concerns on the floating wastes found around Thilafushi that float to the seas.</li> <li>• Concerns that some resorts and individuals would still continue dump in the sea if they did not want to pay for the services of WAMCO.</li> <li>• Monitoring on the health of the people to ensure they are not impacted by the project.</li> <li>• Concern on potential impact of the project to traffic situation in Thilafushi.</li> </ul>
6 August 2019	Ministry of Environment	8	Workers/ employees in Thilafushi  Representatives of NGOs	<ul style="list-style-type: none"> <li>• raised concern wastes dumped at the port at Thilafushi and inquired if there was any mechanism to monitor the waste being dumped to the port.</li> <li>• Raised the issue of recycling of plastic wastes instead of incinerating them.</li> <li>• Concerns on unutilized lots/sites in Thilafushi that become a hub for many migrant workers. It was also noted that these places had very poor living standards and that it needed to be looked into.</li> <li>• Concern on the destruction of the coral reefs because of discharge of cooling water.</li> </ul>

Date of Consultation	Location	No. of Participants	Description /Affiliation of Participants	Issues and Views Raised by Participants
				<ul style="list-style-type: none"> <li>• Suggestion to segregate wastes to minimize hazardous residuals.</li> <li>• Concern on health risks and status in Thilafushi (irritation of eyes, ears and skin, and also difficulty in breathing and an overall decline in health) which is the reason of increased absenteeism, affecting the productivity.</li> </ul>
30 August 2019	Jumhoori Park, Male', Maldives	12	Female Expatriates / Domestic Workers from India	<ul style="list-style-type: none"> <li>• All the participants have not been to Thilafushi yet. However, they understand that the island is where wastes are disposed.</li> <li>• The group felt that improving the waste management at Thilafushi will improve the condition of people working at the island.</li> </ul>
30 August 2019	Jumhoori Park, Male', Maldives	12	Male foreign workers from Bangladesh	<ul style="list-style-type: none"> <li>• Some of the participants has been to Thilafushi and understand the current situation at the island. All aware that the island is where wastes are disposed.</li> <li>• The group felt that improving the waste management at Thilafushi will improve the condition of people working at the island.</li> </ul>
30 August 2019	Jumhoori Park, Male', Maldives	6	Local residents of Male	<ul style="list-style-type: none"> <li>• The group is supportive of the project and felt that improving the waste management at Thilafushi will improve the condition of people working at the island.</li> </ul>
1 September 2019	Thilafushi	9	Male local and foreign workers at Thilafushi	<ul style="list-style-type: none"> <li>• All workers understand the situation and aware of the current impact (e.g. smoke) of the existing dumpsite to the local people of Thilafushi.</li> </ul>
1 September 2019	Thilafushi	8	Male local and foreign workers at Thilafushi	<ul style="list-style-type: none"> <li>• Concern on hearing some explosions due to burning of bottles of canisters from the dump site at night time</li> <li>• Inquiry on when the smoke from the existing dumpsite will be stopped. They view the need to stop this as it endangers the health of the local people.</li> <li>• They are optimistic about the project and hope that the smokestack for the WTE plant will not emit black smoke as what they see now from the existing dump site.</li> </ul>

Date of Consultation	Location	No. of Participants	Description /Affiliation of Participants	Issues and Views Raised by Participants
				<ul style="list-style-type: none"> <li>The groups are supportive of the project and felt that improving the waste management at Thilafushi will improve the condition of people working at the island.</li> </ul>
1 September 2019	Thilafushi	13	Male local and foreign workers at WAMCO	<ul style="list-style-type: none"> <li>Bad experiences working at the existing dumpsite and its surroundings, including the irritation of eyes and catching throat infection due to the smoke from the dumpsite. Taking sick leave becomes a normal case.</li> <li>Views that the smoke from the dump site can be reduced if more equipment are provided to manage the dumped wastes.</li> <li>Happy to continue work at Thilafushi if the waste management is improved.</li> <li>No worries on losing their jobs when the project is completed.</li> <li>The groups are supportive of the project and felt that improving the waste management at Thilafushi will improve the condition of people working at the island.</li> </ul>
2 September 2019	Thilafushi	10	Male local and foreign workers at MTCC	<ul style="list-style-type: none"> <li>Concern on the need to stop work because the smoke from the dumpsite.</li> <li>Smoke entering indoors.</li> <li>Urgent need to address the smoke emission from the dumpsite and better waste management at the island.</li> <li>Issue on workers getting sick which they believe it is due to the smoke.</li> <li>Need to improve the situation at Thilafushi dump site.</li> <li>The WTE project will improve situation at Thilafushi. This will eventually help improve their services by attracting good and experience professional to work at their site.</li> <li>The group felt that improving the waste management at Thilafushi will improve the condition of people working and living at the island. Everyone welcomes the project said they are hoping the implementation of the project</li> </ul>

Date of Consultation	Location	No. of Participants	Description /Affiliation of Participants	Issues and Views Raised by Participants
				would commence soon. They said they hope that the big stack at the new waste to energy plant will not have any visible smoke when it becomes operational.
2 September 2019	Thilafushi	7	Male local workers at GMIZ	<ul style="list-style-type: none"> <li>The group felt that improving the waste management at Thilhafushi will improve the condition of people working and living at the island. Everyone welcomes the project said they are hoping the implementation of the project would commence soon. They said they hope that the big stack at the new waste to energy plant will not have any visible smoke when it becomes operational.</li> </ul>
4 September 2019	Ministry of Environment	13	Residents of Malé and Hulhumale	<ul style="list-style-type: none"> <li>Inquiry on the rationale of using incineration instead of implementing 3Rs.</li> <li>Incinerating high calorific materials such as plastics will discourage/disincentivize the use of single plastic.</li> <li>Incineration does not encourage sorting or segregation of wastes.</li> <li>Treatment of hazardous and medical wastes.</li> <li>Ownership of the energy that will be generated by the WTE plant.</li> <li>Clarification on the capacity of the WTE plant and if it foresees decline in the waste generation in the future.</li> <li>Inquiry on the publication of the EIA report and whether or not the people can submit comments.</li> </ul>
28 October 2019	MNU Auditorium, Male	12	Residents of Male, Representatives of civic groups/NGOs	<p><b>Timing and venue of the public consultation</b></p> <ul style="list-style-type: none"> <li>Some of the participants raised concern that the timing of the public consultation was not ideal as it falls within the official working hours. A participant also suggested that the University Auditorium was not ideal and that the closed space would discourage people from attending the public consultation. It was suggested that future public consultations should be held after the official working hours in the evening and at a public space such</li> </ul>

Date of Consultation	Location	No. of Participants	Description /Affiliation of Participants	Issues and Views Raised by Participants
				<p>as the “Jumhooree park” to encourage more people to attend.</p> <ul style="list-style-type: none"> <li>○ <i>ME informed that the points mentioned would be taken into consideration for future public consultations</i></li> </ul> <p><b>High-level Technology fund</b></p> <ul style="list-style-type: none"> <li>• A participant inquired what was meant by the high-level technology fund <ul style="list-style-type: none"> <li>○ <i>ME informed they would clarify and inform later. Towards the end of the discussion it was informed that a High-Level Technology Fund is a multi-donor trust fund that provides grant financing to encourage more widespread adoption of high-level technology (HLT) to address development challenges in ADB's developing member countries</i></li> </ul> </li> </ul> <p><b>Capacity building</b></p> <ul style="list-style-type: none"> <li>• A participant inquired since there is capacity building in GMEIWMP, what was already being done to acquire information <ul style="list-style-type: none"> <li>○ <i>ME informed that a firm would be hired for capacity building activity and that that the firm would be working throughout the project to build the capacity of the stakeholders, including island communities.</i></li> </ul> </li> </ul> <p><b>Involvement of Women.</b></p> <ul style="list-style-type: none"> <li>• A participant inquired why involvement of women was specified in awareness raising. <ul style="list-style-type: none"> <li>○ <i>ME noted that the project aims to increase the involvement of women throughout the different activities planned in the project and as such even the committee under the Grievance Redress Mechanism also specifies that the president of the island's women's committee be included. Women had been involved in all</i></li> </ul> </li> </ul>



Date of Consultation	Location	No. of Participants	Description /Affiliation of Participants	Issues and Views Raised by Participants
				<p><i>stages of the project development.</i></p> <p><b>Reduction of Waste</b></p> <ul style="list-style-type: none"> <li>• A participant inquired the plans to reduce waste. Another participant added that instead of incinerating, the solution would be to reduce wast, and decrease the import of items that would create waste. <ul style="list-style-type: none"> <li>○ <i>ME informed that under the project there were plans to increase community awareness with regard to waste reduction. The EIA consultant added that there would be a focus on 3R under the community awareness and behaviour change strategies.</i></li> </ul> </li> <li>• A participant raised concern that incineration was being used as the solution to reduce waste and stressed that incineration and re-using the 'gunk' from the incineration plant was not the solution. <ul style="list-style-type: none"> <li>○ <i>In the management of waste, even after carrying out successful waste reduction strategies, there will be residual waste that need to be treated and disposed. Incineration has been recommended as an optimum technology for the Maldives. ME informed that the bottom ash could be utilised for road development and that currently a feasibility study was being undertaken.</i></li> </ul> </li> <li>• A participant inquired if the government's pledge to reduce waste to 3 percent would have an impact on the operation of the plant. <ul style="list-style-type: none"> <li>○ <i>The proposed waste management strategy had taken account to waste reduction strategies. The proposed system would have no impact with current change of policy to ban</i></li> </ul> </li> </ul>

Date of Consultation	Location	No. of Participants	Description /Affiliation of Participants	Issues and Views Raised by Participants
				<p><i>the use of single use plastic by 2024.</i></p> <p><b>Public involvement for the whole project</b></p> <ul style="list-style-type: none"> <li>• A participant raised concern that the public consultation was only for the regional waste management facility and not for the whole project.</li> <li>• Moreover, it was added that public involvement should have been at an earlier stage, before incineration was chosen as the way forward to manage waste, as it is similar to the World Bank waste management project in Vandhoo which had failed. <ul style="list-style-type: none"> <li>○ <i>ME noted that the waste management project for Zone III has been formulated based on the lesson learnt from the Vandhoo Project. Vandhoo project was s a Design and Build project, and the project had failed because the operator of the facility was different and the Government took a while to handover the facility to WAMCO to run the facility. The current project for the Zone III is a DBO, Design, Built and Operate, building on the lessons from Vandhoo case.</i></li> </ul> </li> <li>• A participant added that they were not aware of the level of consultations which had taken place with regard to the project. And that since all government infrastructure development projects (such as the Gulhifalhu Reclamation, development of resorts on shallow, development of harbours in the islands) are related, it needs to be considered, and Mministries and other big companies needs to be consulted before undertaking such a project. <ul style="list-style-type: none"> <li>○ <i>ME informed that stakeholder consultations had taken place at all the stages of project formulation from feasibility to</i></li> </ul> </li> </ul>

Date of Consultation	Location	No. of Participants	Description /Affiliation of Participants	Issues and Views Raised by Participants
				<p><i>EIA. During the feasibility stage, stakeholders were consulted and stakeholder meetings were held. During the designing stage of the project, stakeholders were consulted. Various stakeholders and communities meeting were held for the EIA for this project in the past 24 months. During these meetings, relevant ministries, resorts and companies had also been invited to participate in the stakeholder meetings and workshops.</i></p> <ul style="list-style-type: none"> <li>• Many participants suggested that a multi sectoral discussion should be held for the consultation to be more meaningful. It was also noted that the outcome of the stakeholder meetings was not known to the public.</li> <li>• A participant inquired how much the comments received from the public would be incorporated. Another participant also inquired if the minutes of the meeting would be available. <ul style="list-style-type: none"> <li>○ <i>ME informed that the project formulation has been guided by the inputs from stakeholders in different stages of the project. The minutes of the consultations will be included in the EIA</i></li> </ul> </li> </ul> <p><b>Sustainability of the project</b></p> <ul style="list-style-type: none"> <li>• A participant inquired how the project aligns to the SDG goals 1,2,3. He also added that the project had no engagement of the community. He also stressed that civil society should be part of the project instead of creating mega-companies. He also questioned if such a project would be financially sustainable and the dollar value of the cost to the community. He also inquired how the project would affect the human capital and enhance human development. He also drew examples of the Male' Sewerage Project which in his opinion had failed and did not work</li> </ul>

Date of Consultation	Location	No. of Participants	Description /Affiliation of Participants	Issues and Views Raised by Participants
				<p>as designed, because there was no proper oversight from the regulator of the company. He also highlighted that a gap between the design, installation and operation of a project could affect the sustainability of the project, thus a systematic approach would be needed. Another participant also questioned if the approach was sustainable.</p> <ul style="list-style-type: none"> <li>○ <i>ME noted that the various stakeholders including NGOs and Civil Society groups has been engaged in the project development. The project aims to build the overall institutional capacity in the country. And as such, improving the institutional capacity of EPA is a priority. Moreover, since it's a DBO (Design Build Operate) project, the operational issues would be minimized, and local capacity would be developed before the operation is handed over to the Ministry/WAMCO at the end of the DBO period.</i></li> <li>● A participant inquired if ME could assure that project would be sustainable and the sustainability plans of the project. Similarly, another participant also questioned the sustainability of the project and inquired if all these aspects had been considered. <ul style="list-style-type: none"> <li>○ <i>ME informed that lessons from similar projects were being considered, and feasibility studies were undertaken to ensure the project was viable.</i></li> </ul> </li> </ul> <p><b>No solution for bottom ash</b></p> <ul style="list-style-type: none"> <li>● A participant raised concern that there was no solution for the bottom ash produced from the WTE facility. And stressed that before the project starts there should a proper way for it to be utilised as currently it's only a study which is being undertaken.</li> </ul>

Date of Consultation	Location	No. of Participants	Description /Affiliation of Participants	Issues and Views Raised by Participants
				<p>o <i>EIA consultant briefed that currently there is work going to study the alternative uses for the bottom ash. Presently the study is being focused to use the bottom ash on the production of paving blocks and other similar kind of use in the construction industry. It was also noted that a key objective of the project is to address the waste issue in Thilafushi.</i></p> <p><b>Producer responsibility and consideration of other government projects</b></p> <ul style="list-style-type: none"> <li>• A participant inquired about the details of the grant and loans and suggested that producers should take responsibility of the waste they generate, and if not, it would be a misusing state funds. As such, she highlighted that resorts are one of the biggest generators of waste and that currently waste from all resorts are being taken to Thilafushi. Thus, the participant questioned how thoroughly the project had considered all these issues and stated that the project seems like a reactionary project and a band-aid solution. She also inquired if the increasing number of resorts and other infrastructure projects had been considered. Another participant also inquired if the population growth in the Greater Male' region had been considered.</li> </ul> <p>o <i>EIA consultant briefed the waste to energy facility for the zone III is being financed by ADB through a grant/concessional loan. Resorts bring the waste to Thilafushi because current regulations require the waste from the resorts to be brought to Thilafushi for disposal. The feasibility considered that waste generated from the resorts in the zone III would be brought to Thilafushi for treatment and disposal. WAMCO will be</i></p>

Date of Consultation	Location	No. of Participants	Description /Affiliation of Participants	Issues and Views Raised by Participants
				<p><i>collecting the waste from the resort and the resorts will pay collection fee to WAMCO which includes the cost of treatment/disposal. The feasibility study considered the populations in the zone III, including the planned increase of resort beds in the region.</i></p> <p><b>EIA</b></p> <ul style="list-style-type: none"> <li>• A participant also informed that they had been requesting for the EIA and was yet to receive it. Another participant also questioned the results of the EIA, as the participant stated that Thilafushi was dead in terms of biodiversity thus the results were questionable. <ul style="list-style-type: none"> <li>○ <i>ME informed that the EIA would be shared once the EIA is finalised. It was mentioned that the EIA and annexes including the studies that is part of the EIA would be made available at the ADB website soon for comments. It would be made available on the website for a period of 3 months. EPA would also publish it on their website, once the ME submits the final EIA to EPA.</i></li> </ul> </li> </ul> <p><b>Inefficiency and ineffectiveness of ME and EPA</b></p> <ul style="list-style-type: none"> <li>• Participants raised concern over the ineffectiveness of Ministry of Environment and the Environmental Protection Agency. It was noted that they do not hear back from the organisations in a timely manner for other matters that they have contacted to those institutions. It was also noted that EPA should have the capacity monitor air emission levels from the project. <ul style="list-style-type: none"> <li>○ <i>PM noted that the project would response on any queries regarding this waste project. ME noted that part of the project is to build the capacity of EPA and strengthen institutional capacity</i></li> </ul> </li> </ul>

Date of Consultation	Location	No. of Participants	Description /Affiliation of Participants	Issues and Views Raised by Participants
				<p><i>to monitor the air pollution emissions. Air pollution emission stations are recommended to be established at Thilafushi to monitor the impacts of stack emission on Thilhafushi.</i></p> <p><b>Other waste</b></p> <ul style="list-style-type: none"> <li>• A participant inquired how hazardous waste, medical waste, construction and demolition waste, and end of life vessels would be handled at Thilafushi when this project is completed. <ul style="list-style-type: none"> <li>○ <i>ME noted that all the hospitals and health care facilities are required to have autoclaves to treat the medical waste before it is sent to Thilhafushi for treatment and disposal. The proposed facility can manage the hazardous waste in the household. The facility would store any other hazardous waste received. The facility can receive end of life vehicles. ME noted that the facility at Thilhafushi is a municipal solid waste incinerator facility. Government is developing another facility to treat hazardous waste.</i></li> </ul> </li> </ul>

510. In summary of the outcome of the consultations undertaken, the overall impression suggests support of all stakeholders on the project with the view that the solid waste management system in Thilafushi and project area is improved. Main concern of stakeholders is the request to stop the continuous emission of smoke from the existing dumpsite in Thilafushi as they perceive it to be the major cause of health problems in the island. All issues raised that are related to potential impacts of the project have been taken into consideration in this EIA, particularly in providing mitigation measures to avoid or minimize these impacts. As part of full disclosure policy in ADB projects, this EIA report shall be made available to the public and could provide comments on its contents, if any. These comments shall be reviewed and included in further enhancing the EIA report.

## **B. Future Consultation Activities**

511. MOE, through the PMU, will continue to conduct meaningful consultations<sup>46</sup> with all stakeholders to ensure they are engaged throughout the design, construction, commissioning and

<sup>46</sup> Per ADB SPS, meaningful consultation is a process that (i) begins early in the project preparation stage and is carried out on an ongoing basis throughout the project cycle; (ii) provides timely disclosure of relevant and adequate information that is understandable and readily accessible to affected people; (iii) is undertaken in an atmosphere free

operational phases of the project. Meaningful consultation will be a continuing activity in order to establish a foundation of mutual trust and provide a forum for the exchange of information, through which any issues can be raised with the project team and addressed by agreed action where necessary. This will involve:

- (i) Public meetings as the main forum through which the local community will be informed about the progress of the project and any elements that may affect them (such as temporary restrictions in access during the construction period, the timing of deliveries of large equipment items, etc.). These meetings could be held according to need, and the program will be agreed in advance and published on government gazette and in the local press.
- (ii) Additional meetings will be held on an ad hoc basis with institutional stakeholders, including government officials where necessary. The aim will be to inform all relevant agencies of project progress and allow discussion and resolution of any specific issues as they may arise.
- (iii) Focus group sessions could be again be held with the local community when needed, to discuss and organize specific activities and to deal with any issues that can be handled in this way.

512. The PMU will also be supported by a public awareness and community capacity building (PACCB) consultant, a consulting firm that will help generate awareness and strengthen skills in waste collection, segregation, compositing, recycling, and O&M targeting the poor and women, including community awareness campaign for strengthening disaster risk reduction and climate change readiness. PACCB is responsible for the IEC initiatives and public awareness on waste-to-energy as described in Appendix 3 of the Project Administration Manual.

### **C. Information Disclosure**

513. The Ministry of Environment, through the PMU, will comply with the disclosure requirements of ADB SPS and national law, and will ensure that the final EIA report will be disclosed and made available for review by the local community and other stakeholders. PMU will submit a copy of the EIA report to ADB for final review and disclosure on ADB website. PMU will also disclose the ADB-approved version of the EIA report on the project website. For any updating of the EIA in the future, PMU will ensure that the updated or revised EIA report is submitted to ADB for another review and disclosure on ADB website. Similarly, all other reports such as quarterly environmental monitoring reports produced throughout the construction and operation stages of the project will also be reviewed and disclosed in the same way.

514. In compliance with the Maldives EIA Regulation, the EIA report will be submitted to the Maldives EPA for its consideration before such report is reviewed and approved. The Maldives EPA will make the report public on their website. The public can access the full EIA report from the Maldives EPA's website ([www.epa.gov.mv](http://www.epa.gov.mv)). The project-affected groups and local nongovernment organizations can provide their comments/inputs to Maldives EPA in their deliberation, within 28 working days before the Maldives EPA makes a decision regarding acceptance of the Maldives EPA report for the project.

---

of intimidation or coercion; (iv) is gender inclusive and responsive, and tailored to the needs of disadvantaged and vulnerable groups; and (v) enables the incorporation of all relevant views of affected people and other stakeholders into decision making, such as project design, mitigation measures, the sharing of development benefits and opportunities, and implementation issues.



## VIII. GRIEVANCE REDRESS MECHANISM

515. The project will adopt the grievance redress mechanism (GRM) as outlined in the EIA report. This will ensure that consultation, disclosure and community engagement continue throughout project implementation. The grievance redress mechanism will allow for concerns and grievances about the project's social and environmental performance raised by individuals or groups from among project-affected communities to be received and to facilitate resolution of those concerns and grievances. The Grievance Redress Mechanism includes 3 tiers. Every effort shall be given to find an amicable solution before higher tiers could be engaged. The project GRM will not supersede any legal government grievance procedures. Affected people are to be informed about the mechanism through media and public outlets. This participatory process shall ensure that all views of the people are adequately reviewed and suitably incorporated in the design and implementation process. An information board providing the contact details will be made available at the project site at Thilafushi, and a register of grievances will be maintained at MOE.

### A. First Tier (DBO Contractor)

516. An individual or an interest group can contact DBO Contractor for grievances.

- (i) At the project location there will be an Information Board listing the names and contact telephones/emails.
- (ii) If the complaint is resolved within 10 days, DBO Contractor must communicate the decision to the aggrieved party in writing.
- (iii) If no satisfactory solution is reached through the Tier I process, the aggrieved party may notify the MOE, in writing of the intention to move to Tier II.

### B. Second Tier (PMU/MOE)

517. An individual or an interest group can contact PMU/MOE for grievances.

- (i) At the project location there will be an Information Board listing the names and contact telephones/emails.
- (ii) If the grievance cannot be resolved informally by contacting DBO Contractor, an aggrieved party must submit a complaint on the Tier 2 by sending an email to [secretariat@environment.gov.mv](mailto:secretariat@environment.gov.mv)
- (iii) If the complaint is resolved within 15 days MOE must communicate the decision to the aggrieved party in writing.
- (iv) If a complaint requires more time to address, this requirement must be communicated to the aggrieved party in writing and the aggrieved party must consent and sign-off the request for the extension to take effect. An extension can be made to an additional 15 days.
- (v) Complaint Form. A copy of the form should be provided to the aggrieved party as evidence of receipt. The complaint form should be available from the website of MOE.

### C. Third Tier (Judiciary)

518. An individual or an interest group has the option of going to established judiciary system of the Maldives.

- (i) The legal system is accessible to all aggrieved persons.
- (ii) Assistance from the MOE would be available only for vulnerable person as per this grievance mechanism.
- (iii) In cases where vulnerable person(s) are unable to access the legal system, the Attorney General's office will provide legal support to the vulnerable person(s).
- (iv) The verdict of the Courts will be final.
- (v) A vulnerable person(s) for the purpose of this project is a person who is poor, physically or mentally disabled/handicapped, destitute, and disadvantaged for ethnic or social reasons, an orphan, a widow, a person above sixty-five years of age, or a woman heading a household.

519. The affected persons can also direct contact (in writing) the ADB Project Officer at ADB headquarters. The complaint can be submitted in any of the official languages of ADB's Developing Member Countries. This may be done at any time by sending the written complaint to the following address:

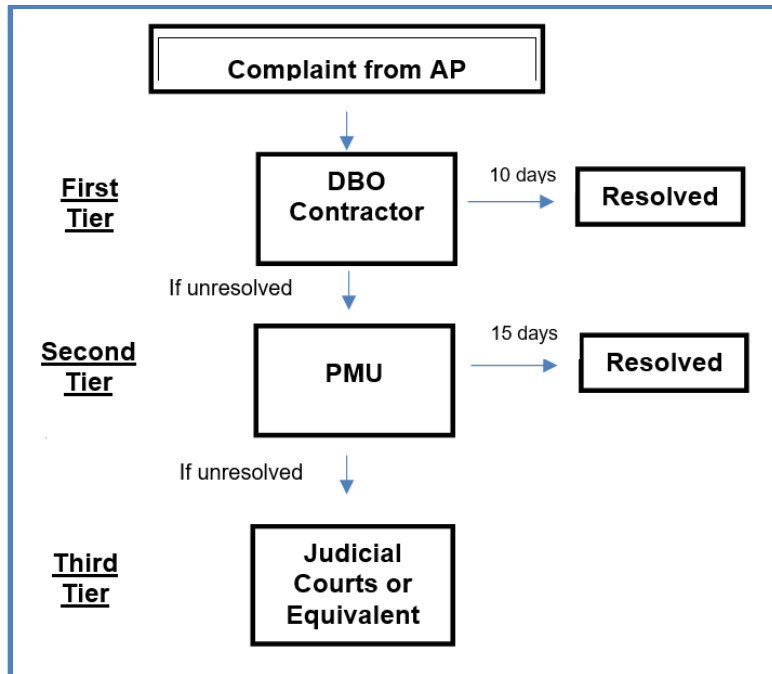
Project Officer – Greater Malé Environmental Improvement and Waste Management Project  
South Asia Urban Development and Water Division  
South Asia Regional Department  
Asian Development Bank  
6 ADB Avenue, Mandaluyong City 1550  
Metro Manila, Philippines

520. The APs can also use the ADB Accountability Mechanism (AM) through directly contacting (in writing) the Complaint Receiving Officer (CRO) at ADB. The complaint can be submitted in any of the official languages of ADB's DMCs. The ADB Accountability Mechanism information will be included in the Project Information Document to be distributed to the affected communities, as part of the project GRM.

521. The GRM notwithstanding, an aggrieved person shall have access to the country's legal system at any stage through the Maldives judicial or appropriate administrative system. This can run parallel to accessing the GRM and is not dependent on the negative outcome of the GRM.

522. The flow diagram of resolving complaints under the GRC is shown in Figure 130 below.

**Figure 130: Grievance Redress Mechanism Diagram**



## IX. ENVIRONMENTAL MANAGEMENT PLAN

### A. Objectives

523. Environmental Management Plan (EMP) is the document through which mitigation measures are proposed following the assessment of the impacts of a project. The EMP sets out the mitigation measures to these impacts, monitoring plan and institutional arrangements that need to be observed during construction and operation of the WTE plant. The budgets to cover the cost of implementing the EMP, including costs associated with implementing the GRM, are also provided.

524. The purpose of the EMP is to ensure that the activities are undertaken in a responsible, non-detrimental manner with the objectives of: (i) providing a proactive, feasible, and practical working tool to enable the measurement and monitoring of environmental performance on-site; (ii) guiding and controlling the implementation of findings and recommendations of the environmental assessment conducted for the project; (iii) detailing specific actions deemed necessary to assist in mitigating the environmental impact of the project; and (iv) ensuring that safety recommendations are complied with.

525. The EMP also sets out the mitigation measures that the DBO Contractor is required to provide during project design, construction and operation, and the manner in which the PMU requires the mitigation to be provided. The EIA report will be included in the DBO bidding and contract documents, so by accepting the contract, the chosen DBO Contractor will be legally obliged to implement all specified mitigation measures; including the allocation of budget to implement all mitigation measures and monitoring activities required in the EMP, and provisional sum that will ensure funding for any budget shortfall or for addressing any unanticipated impacts during the construction and operation phases of the project. The methods to be used for site preparation, construction, operation, and commissioning, as well as associated arrangements to ensure sound environmental management and safety at all times, are already defined in the bid

documents. The DBO Contractor shall prepare a site-specific EMP (SEMP) based on the EMP presented in this EIA report in order to make it relevant to the construction and operation phases. The DBO Contractor shall prepare SEMP describing specific design features that will ensure environmental protection and setting out the working methods, management, and mitigation and monitoring measures that will be put in place, for each of the various construction activities, during the implementation of the project. The scope of the SEMP shall address all of the issues itemized in the EMP in this EIA report. The SEMP shall have the same level or stricter set of measures than those included in the EMP of this EIA report. The SEMP shall consider ISO 14001 when detailing the environmental management system in place. The DBO Contractor shall submit the updated EMP to PMU. PMU shall submit a copy of the updated EMP to ADB for review and disclosure.

526. However, if there will be significant changes in the final detailed design compared to the preliminary design used in the EIA, the DBO Contractor shall update the EIA report, including the EMP and EMOP, accordingly, including budget that will cover implementation of any added mitigation measures and monitoring activities. The DBO Contractor shall submit the updated EIA to PMU, and the PMU shall submit the updated EIA to ADB for final review and disclosure.

527. The DBO Contractor will be required to (i) establish an operational system for managing environmental impacts (ii) carry out all of the monitoring and mitigation measures set forth in the EMP and SEMP; (iii) implement any corrective or preventive actions set out in safeguards monitoring reports that PMU will prepare from time to time to monitor implementation of this EIA and EMP; and (iv) allocate a budget for compliance with these EMP measures, requirements, monitoring activities and actions, including provisional sum where to draw budget for any shortfall in the initial budget estimates and for addressing any unanticipated impacts during construction and operation phases of the project.

## **B. Institutional Arrangement**

528. **Implementation Arrangements.** The executing agency is the Ministry of Finance (MOF). The implementing agency is the Ministry of Environment (MOE) which establish a project management unit (PMU) comprising officials and staff from MOE. The PMU will be continuously strengthened with external experts as may be needed through the project implementation. The project steering committee chaired by Minister, through the MOE, will provide overall guidance and strategic directions to the project. The PMU will be supported by a project management, design and supervision consultant (PMDSC), a professional engineering and management consulting firm. PMDSC will assist in the delivery of the different project components, which include the design, construction and initial operations (including capacity building of EPA, MOE and PMU in monitoring operations) of WTE facility and associated landfill of air pollution control residuals and non-marketable incineration bottom ash. PMDSC will act as MOE's representative during the design and build period and the first two years after the successful commissioning of the WTE plant (operation period). PMDSC will have a national and international environmental safeguards specialist consultant responsible for overseeing implementation of environmental safeguards on behalf of MOE and PMU. The terms of reference for PMDSC is attached as Appendix 10. The DBO Contractor will be responsible for the design and implementation of the project, and other responsibilities as indicated in the DBO contract documents. The PMU will also be supported by a public awareness and community capacity building (PACCB) consultant, a consulting firm that will help generate awareness and strengthen skills in waste collection, segregation, composting, recycling, and O&M targeting the poor and women, including community awareness campaign for strengthening disaster risk reduction and climate change readiness.

529. **Project Management Unit.** MOE has set up a PMU at its Waste Department. The PMU will oversee the implementation of the project by the DBO Contractor. PMU staff comprise eight staff as follows: (i) Project Director (part-time, Director General of Department), (ii) Project Manager, (iii) Procurement Specialist, (iv) Finance Specialist, (v) Safeguard Specialist, (vi) Civil Engineer, (vii) Information, Education and Communication (IEC) Specialist, and (viii) administrative assistant. The Project Director (part-time) is empowered to take official decisions, while remaining PMU staff (full time) are recruited from the market. The PMU will be supported by the PMDSC and PACCB consultants for project management, capacity building, monitoring, and technical design and supervision support.

530. **Terms of Reference for PMU Environment Officer.** Key tasks and responsibilities of the PMU environment officer are as follows:

- (i) Ensure that EIA report with the EMP is updated based on final detailed designs, in coordination with the DBO Contractor;
- (ii) Ensure that EIA report with the EMP is included in DBO bidding and contract documents;
- (iii) Ensure that costs for implementing the EMP, including those special cost indicated in Table 55, are included in the BOQ (or equivalent) of the DBO bidding and contract documents;
- (iv) Ensure that the DBO Contractor's SEMP is consistent with the EMP. The SEMP shall have the same level of detail or stricter mitigation measures than the EMP;
- (v) Provide oversight on environmental management aspects of the project and ensure EMP and SEMP are implemented by the DBO Contractor;
- (vi) Establish a system to monitor environmental safeguards of the project, including monitoring the indicators set out in the monitoring plan of the EMP;
- (vii) Confirm compliance of DBO Contractor with obtaining statutory clearances or permits required under the project, including environmental clearances as applicable;
- (viii) Review, monitor, and evaluate the effectiveness with which the EMPs are implemented, and recommend necessary corrective actions to be taken as necessary;
- (ix) Consolidate monthly environmental monitoring reports from DBO Contractor and submit quarterly monitoring reports to ADB and required reports to Maldives EPA;
- (x) Ensure timely disclosure of final EIA report in locations and form accessible to the public;
- (xi) Address any grievances brought about through the grievance redress mechanism in a timely manner;
- (xii) Provide assistance to DBO Contractor's EHS Manager (as may be needed) on delivering orientation to DBO Contractor's personnel regarding environmental management arrangements for the project;
- (xiii) Visit worksites during construction phase and WTE plant site during operation phase, and provide guidance relating to supervision and compliance monitoring;
- (xiv) Provide necessary support to the external environmental expert consultant who will be retained under the project (see below description of external environmental expert); and
- (xv) Provide inputs to progress reports and the project completion report.

531. **PMDSC Environmental Safeguards Specialists.** The PMDSC Environmental Safeguards Specialist Consultants will have the following responsibilities:

- (i) Assist PMU in meeting requirements of ADB SPS and government on environment, occupational health and safety, and labor standards.
- (ii) Assist PMU in obtaining all necessary permissions and complying with statutory requirements;
- (iii) Ensure DBO Contractor submits requirements per EMP and government clearances/permits,
- (iv) Provide support to DBO Contractor in preparing the site-specific EMP (SEMP) to ensure ADB SPS and conditions in government clearances are incorporated accordingly;
- (v) Assist PMU in updating the EIA for any change in scope, design, location, or unanticipated impacts that are not reported in the EIA;
- (vi) Review any changes in the DBO Contractor's design and support PMU in ensuring environmental assessment, impacts avoidance and mitigation measures are reflected in the SEMP and updated EIA
- (vii) Assist the DBO Contractor and the PMU in all EPA related clearances, and ADB's no-objection, and monitor and control construction and assembly compliance against the updated EIA, ADB SPS, and SEMP;
- (viii) Monitor the contractors' compliance with all safety requirements as stated in DBO contract and SEMP, during and prior to any construction activity.
- (ix) Assist in preparation of accident report and keeping accident records on-site as required;
- (x) Monitor the implementation of the SEMP during construction and pre/post construction phases;
- (xi) Assist PMU in continuing stakeholders engagement, consultations, information disclosure and addressing complaints/grievances;
- (xii) Develop public awareness program and materials to support wider understanding of the project, potential impacts and measures to ensure impacts are avoided, mitigated and affected people, if any, are compensated;
- (xiii) Assist PMU in preparation of environmental monitoring reports
- (xiv) Coordinate with external environmental experts on results of independent monitoring and support PMU to prepare corrective actions, if required
- (xv) Provide and organize trainings/workshops/seminars on environmental safeguards, occupational health and safety, and labor standards
- (xvi) Assist PMU in review of contractor's health and safety program and in monitoring its implementation;
- (xvii) Support PMU during ADB review missions;
- (xviii) Support PMU in developing data management system on environmental safeguards; and
- (xix) Other tasks related to environmental safeguards, occupational health and safety, and labor standards.

532. **DBO Contractor.** The DBO Contractor will have primary responsibility for implementing the EMP during the construction stage and will:

- (i) Appoint a qualified full-time environmental health and safety (EHS) manager to manage implementation of the EMP and monitoring plan;
- (ii) Ensure that sufficient number of engineers/staffs are trained effectively on the implementation of the EMP and SEMP who will assist the EHS manager, subject

- to internal manpower arrangements. No shift schedules shall be without either the EHS manager or at least one trained engineer/staff on EMP and SEMP implementation;
- (iii) Obtain necessary environmental license(s), permits, etc. from relevant agencies as prior to commencement of civil works contracts;
  - (iv) Undertake all necessary studies required in this EIA report, such as, climate vulnerability and risk assessment at the proposed site, among others as may be deemed necessary;
  - (v) Prepare all work program and pre-approved project plans required for implementing the EMP during construction phase as follows:
    - a. Construction Waste Management Plan;
    - b. Occupational Health and Safety Plan following international best practices on occupational health and safety such as those in Section 4.2 of IFC EHS Guidelines on Construction and Decommissioning Activities;
    - c. Construction Camp Development and Management Plan;
    - d. Spill Control and Containment Plan;
    - e. Marine and Beach Area Construction Work Plan;
    - f. Erosion Control Plan for pipeline works; and
    - g. Traffic Management Plan around the construction site to ensure easy access and passage of workers and employees of establishments at two sides of the project site;
  - (vi) Prepare all work program and pre-approved project plans required for implementing the EMP during operation phase as follows:
    - a. Operation and Maintenance Manual;
    - b. Waste Screening Procedure / Plan to ensure all waste inputs to the facility comply with quantity and quality requirements, including accounting of hazardous / halogenated organic components in wastes, if practical;
    - c. In-house Solid Waste Management Plan;
    - d. Occupational Health and Safety Plan following international best practices on occupational health and safety such as those in IFC EHS Guidelines on Waste Management Facilities;
    - e. Spill Control and Containment Plan; and
    - f. Emergency and Disaster Preparedness and Response Plan;
  - (vii) Implement all mitigation measures in the EMP and activities in the Monitoring Plan, including allocation of budget to implement the EMP/SEMP, monitoring program and measures for any unanticipated impacts during the construction and operation phases of the project;
  - (viii) Ensure that all workers, site agents, including site supervisors and management participate in training sessions delivered by the project proponent;
  - (ix) Ensure compliance with environmental statutory requirements and contractual obligations;
  - (x) Participate in resolving issues as a member of the Grievance Redress Committee;
  - (xi) Respond promptly to grievances raised by the local community or any stakeholder and implement time-bound environmental corrective actions or additional environmental mitigation measures as necessary;
  - (xii) Based on the results of EMP monitoring, cooperate with the PMU to prepare and implement time-bound corrective action plans, as necessary; and

- (xiii) Provide necessary support to the external environmental expert consultant who will be retained under the project (see below description of external environmental expert);

533. **External Environmental Expert.** In compliance with the requirement of ADB SPS, the project, as a Category A undertaking with significant impacts and risks, shall retain an external environmental expert consultant who will verify monitoring information. The environmental expert shall have expertise on WTE project operations and experience in management and monitoring of environmental impacts of such kind of development projects. The environmental expert shall be retained starting from the time the DBO Contractor mobilizes up to the operation phase. The environmental expert will coordinate and work closely with PMU and the DBO Contractor when planning or fielding monitoring activities, including requests for information or documents that will facilitate the task. Per ADB SPS, the environmental expert shall not be involved in day-to-day project implementation or supervision of the project and will report directly to ADB, or occasionally through the PMU. The terms of reference of the environmental expert is attached as Appendix 11.

### **C. Environmental Management Plan**

534. Table 53 shows the Environment Management Plans (stage-wise) summarizing the potential adverse environmental impacts, proposed mitigation measures, responsible parties, and cost of implementation. This EMP will be included in the DBO bidding and contract documents and will be further reviewed and updated, including the specific costs, during detailed design phase. Table 54 shows the proposed Environmental Monitoring Plan (EMOP) for the project. It includes all suggested environmental parameters, description of sampling stations, frequency of monitoring, applicable standards, and responsible parties. Likewise, the EMOP will be further reviewed and updated during the detailed design phase.



**Table 53: Environmental Management Plan Matrix**

Field or Activity	Potential Impact / Issue	Mitigation Measures	Parameter / Indicator of Compliance	Monitoring Frequency	Implementation Agency	Monitoring Agency	Estimated Cost
<b>Pre-Construction / Design Stage</b>							
Invitation for Bids	<ul style="list-style-type: none"> <li>Bidding documents are issued without the EMP and/or the EIA prepared for the project</li> </ul>	<ul style="list-style-type: none"> <li>No bidding documents shall be issued without having the mitigation measures and monitoring requirements in the EIA report included in the safeguard clauses of technical specifications in bidding and contract documents.</li> </ul>	<ul style="list-style-type: none"> <li>Bidding and contract documents include safeguard provisions</li> </ul>	<p>During drafting of bidding and contract documents</p> <p>Before the issuance of bidding documents for IFB</p> <p>Before awarding of contracts</p>	PMU - Ministry of Environment	Ministry of Environment	None.
Locating intake and outfall of cooling/thermal water.	<ul style="list-style-type: none"> <li>Damage to reef and marine ecology around Thilafushi island due to high temperature and high concentration (brine solution).</li> </ul>	<ul style="list-style-type: none"> <li>If necessary, undertake coral and benthic study following Reef Check protocol.</li> <li>Confirm that the pre-identified best location for intake and outfall is acceptable to the DBO Contractor. If changes are planned, the DBO Contractor shall ensure that withdrawal cooling water and discharge of cooling water will have no or minimum impact to underwater ecosystem.</li> <li>Contract documents to include performance guarantee by the facility that hot water discharge shall have maximum temperature difference of 3 degrees Celsius from the ambient temperature.</li> <li>Undertake hot water dispersion modeling along the planned area of discharge. Ensure that this area is with no or least</li> </ul>	Planned and implemented Numerical modeling output for 4 seasons	<p>Once to review modeling output.</p> <p>Once during finalization of outfall configuration</p>	DBO contractor through a preapproved agency	PMU	Part of DBO Contract

Field or Activity	Potential Impact / Issue	Mitigation Measures	Parameter / Indicator of Compliance	Monitoring Frequency	Implementation Agency	Monitoring Agency	Estimated Cost
		<p>marine species that could be affected based on the underwater ecology study (as described above).</p> <ul style="list-style-type: none"> <li>• If there will be changes in the location of cooling water discharge location, the DBO Contractor shall conduct confirmatory numerical modeling for brine discharge—both near and far-field, covering all 4 seasons (2 monsoon and 2 inter-monsoon) to ensure the location of discharge will not have significant impact to marine environment.</li> <li>• Ensure that design considers achievement of proper mixing and rapid dilution within a small area around the outfall.</li> <li>• Consider in the design the combined outfall for hot water and treated wastewater to minimize impact to marine ecosystem.</li> </ul>					
Locating ambient air quality monitoring stations	Improper locations of sampling locations leading to underestimated ambient air quality condition and health risk to people.	<ul style="list-style-type: none"> <li>• Contract documents to include performance guarantee for the facility that emissions comply with applicable standards.</li> <li>• Conduct wind data gathering for various seasons of the year to map projected wind directions at any season during plant operations.</li> <li>• Design smokestacks with height that will ensure emissions will have no or minimum impact to surrounding receptors within the direct and indirect impact zones.</li> <li>• Undertake air dispersion modeling to show and</li> </ul>	<ul style="list-style-type: none"> <li>• Ambient air monitoring station site map</li> </ul>	Once of during the detail design stage	DBO contractor	PMU	Part of DBO Contract

Field or Activity	Potential Impact / Issue	Mitigation Measures	Parameter / Indicator of Compliance	Monitoring Frequency	Implementation Agency	Monitoring Agency	Estimated Cost
		<p>understand the behavior and movement of components of flue gas from the stacks.</p> <ul style="list-style-type: none"> <li>Based on the dispersion modeling, identify the appropriate sampling locations for ambient air quality in Thilafushi island and other islands nearby, if necessary and practical.</li> <li>Undertake baseline ambient air quality data gathering with due consideration of the direction of flow of smoke from the existing dumpsite</li> </ul>					
Locating proper drainage system around the facility	Disturbance to and impedance of flow in natural drainage around the island.	<ul style="list-style-type: none"> <li>Identify and demarcate drainage lines within and around the WTE site, including approach roads. Ensure that these channels do not disturb or impede natural flow of storm water from the island to the sea.</li> <li>Provide cross drainage structures wherever necessary along the new approach roads.</li> <li>Integrate the above considerations in the final drainage plan for the project site.</li> </ul>	<ul style="list-style-type: none"> <li>Site drainage plan</li> </ul>	Once of during the detail design stage	DBO contractor	PMU	Part of DBO Contract
Physical integrity of proposed project site.	Failure of site to withstand proposed project infrastructures.	<ul style="list-style-type: none"> <li>Integrate results of geotechnical study undertaken by the government to the design of project infrastructures.</li> </ul>	<ul style="list-style-type: none"> <li>Geotechnical study report.</li> <li>Recommendations of geotechnical study integrated in detailed design.</li> </ul>	Continuing during detailed design stage.	DBO contractor	PMU	Part of DBO Contract
	Failure of site to withstand climate change, including extreme	<ul style="list-style-type: none"> <li>Undertake and include results of climate vulnerability and risk assessment (CVRA) in the design of the project.</li> </ul>	<ul style="list-style-type: none"> <li>CVRA report</li> <li>Recommendations of the CVRA report integrated in detailed design.</li> </ul>	Continuing during detailed design stage.	DBO contractor	PMU	Part of DBO Contract

Field or Activity	Potential Impact / Issue	Mitigation Measures	Parameter / Indicator of Compliance	Monitoring Frequency	Implementation Agency	Monitoring Agency	Estimated Cost
	weather events.	<ul style="list-style-type: none"> <li>• Provide site protections based on the risks identified in the CVRA.</li> </ul>					
Work program and pre-approved plans	Unprecedented and multiple environmental impacts due to poor or inappropriate plans integrated in the design of the project.	<ul style="list-style-type: none"> <li>• Develop the following plans that shall be included in the final detailed design and implemented during construction stage:               <ul style="list-style-type: none"> <li>○ Construction Waste Management Plan.</li> <li>○ Occupational Health and Safety Plan following international best practices on occupational health and safety such as those in Section 4.2 of IFC EHS Guidelines on Construction and Decommissioning Activities.</li> <li>○ Construction Camp Development and Management Plan.</li> <li>○ Spill Control and Containment Plan</li> <li>○ Marine and Beach Area Construction Work Plan</li> <li>○ Erosion Control Plan for pipeline works</li> <li>○ Traffic Management Plan around the construction site to ensure easy access and passage of workers and employees of establishments at two sides of the project site.</li> </ul> </li> <li>• Develop the following plans or manuals that shall be utilized during operation stage:               <ul style="list-style-type: none"> <li>○ Operation and Maintenance Manual</li> </ul> </li> </ul>	<ul style="list-style-type: none"> <li>• Work plans included in the final detailed design of the project</li> <li>• Work schedule for each plan included in the overall schedule of project implementation.</li> </ul>	Once prior to start of construction works.	DBO contractor	PMU	Part of DBO Contract

Field or Activity	Potential Impact / Issue	Mitigation Measures	Parameter / Indicator of Compliance	Monitoring Frequency	Implementation Agency	Monitoring Agency	Estimated Cost
		<ul style="list-style-type: none"> <li>○ Waste Screening Procedure / Plan to ensure all waste inputs to the facility comply with quantity and quality requirements, including accounting of hazardous / halogenated organic components in wastes.</li> <li>○ In-house Solid Waste Management Plan.</li> <li>○ Occupational Health and Safety Plan following international best practices on occupational health and safety such as those in IFC EHS Guidelines on Waste Management Facilities.</li> <li>○ Spill Control and Containment Plan.</li> <li>○ Emergency and Disaster Preparedness and Response Plan.</li> </ul>					
Consents, permits, clearances, no objection certificate (NOC), etc.	Stoppage of activities due to lack of permits or clearances from the local and national governments.	<ul style="list-style-type: none"> <li>● Obtain all necessary consents, permits, clearance, NOCs, prior to start of civil works.</li> </ul>	<ul style="list-style-type: none"> <li>● Clearances and approvals</li> </ul>	Once prior to start of construction	DBO contractor	PMU	No additional costs
Shifting of Utilities	Damage to existing utilities that will disturb operations of establishments or businesses near the site.	<ul style="list-style-type: none"> <li>● Identify and include locations and operators of these utilities in the detailed design to prevent unnecessary disruption of services during the construction phase.</li> <li>● Prepare a contingency plan to include actions to be done in case of unintentional interruption of services, such as the following:</li> </ul>	<ul style="list-style-type: none"> <li>● Maps showing utilities and likely disruptions</li> </ul>	Once prior to start of construction.	DBO contractor	PMU	No additional costs

Field or Activity	Potential Impact / Issue	Mitigation Measures	Parameter / Indicator of Compliance	Monitoring Frequency	Implementation Agency	Monitoring Agency	Estimated Cost
		<ul style="list-style-type: none"> <li>○ In case of water supply disruption, provide temporary water supply source for the affected establishments.</li> <li>○ In case of power interruption, provide prior notice to affected establishments. If interruption is unscheduled due to unforeseen incidents, provide a standby generator set to serve as temporary power supply to affected establishments.</li> <li>● Identify the list of affected utilities and operators and coordinate closely with relevant government departments.</li> </ul>					
Locating sites for construction work camps, areas for stockpile, storage and disposal	Greater level of impact or pollution due to location of worker camp, raw material storage areas and temporary waste/spoil storage sites	<ul style="list-style-type: none"> <li>● Except disposal sites, all the work sites (camps, storage, stockpiles etc.) will be located within the selected site.</li> <li>● No construction camp shall be located on the beach or overwater.</li> <li>● Material shall be brought to site as and when required, and temporary storage of material (pipe, sand etc.) shall be made near the work site.</li> <li>● No temporary storage shall be located at the lagoon section</li> <li>● Waste shall be disposed in existing approved disposal sites; any new sites shall be developed considering siting guidelines, maintained and operated accordingly</li> </ul>	<ul style="list-style-type: none"> <li>● List of preapproved sites for construction work camps, areas for stockpile, storage and disposal</li> <li>● Construction Waste Management Plan</li> </ul>	Once prior to start of construction	DBO contractor	PMU	No additional costs

Field or Activity	Potential Impact / Issue	Mitigation Measures	Parameter / Indicator of Compliance	Monitoring Frequency	Implementation Agency	Monitoring Agency	Estimated Cost
Sourcing of construction materials	Environmental impacts (air, water, soil, biodiversity, etc.) at the source.	<ul style="list-style-type: none"> <li>Obtain construction materials for this project from the licensed quarries acceptable to government</li> <li>For new borrow sites to borrow fill material and backfill material, prior permission must be obtained from Maldives EPA, and the environmental impacts of the operation should be properly examined and mitigated as necessary</li> <li>Make efforts to minimize the overall material requirement for the project by adopting various approaches –balanced cut and fill, re-use as much excavated material from this project as possible</li> <li>Submit to PMU on a monthly basis, documentation (materials quantities with source).</li> </ul>	Permits issued to quarries/sources of materials	Once prior to start of construction	DBO contractor	PMU	No additional costs
Delivery route for construction materials and equipment	Port congestion at Thilafushi due to transport of construction equipment and raw materials at site	<ul style="list-style-type: none"> <li>Identify a separate berth location for loading and unloading construction heavy equipment and raw materials that will not disrupt day-to-day activities in the island. Avoid use of the common ports being used by locals.</li> <li>If no other areas available, execute agreement with WAMCO to use WAMCO's berths/docking ports when delivering heavy equipment and big-sized construction materials to the site.</li> </ul>	Maps showing delivery routes.	Once prior to mobilization by DBO Contractor	DBO contractor	PMU	No additional costs
Final Detailed Design Components	Air and marine water pollution due to inappropriate	<ul style="list-style-type: none"> <li>Ensure the final detailed design will integrate the following mandatory requirements:</li> </ul>	Detailed design that uses recommendations of the EIA report.	Continuing during detailed design stage.	DBO Contractor	PMU	Part of DBO contract

Field or Activity	Potential Impact / Issue	Mitigation Measures	Parameter / Indicator of Compliance	Monitoring Frequency	Implementation Agency	Monitoring Agency	Estimated Cost
	components included in the detailed design.	<ul style="list-style-type: none"> <li>○ Use of best practical incineration technology as recommended in the EIA.</li> <li>○ Use of stack height recommended in the EIA. If circumstances on the basis of the recommended stack height have changed (e.g. change in dimensions of the WTE plant building structure), ensure to use a stack height that is based on a new modeling calculation.</li> <li>○ Installation of air pollution control device that will ensure emissions comply with the emission standards as indicated in the EIA.</li> <li>○ Ensure to include installation of a continuous monitoring system (CEMS) as a mandatory requirement in the design.</li> <li>○ Appropriate sampling port at the stack for random grab sampling activities.</li> <li>○ Leachate treatment plant designed based on (i) maximum expected volume of leachate generated, and (ii) full capacity operation of the WTE plant.</li> <li>○ Residual waste landfill designed based on (i) maximum volume of fly ash and bottom ash generation, and (ii) full capacity operation of the WTE plant.</li> </ul>					



Field or Activity	Potential Impact / Issue	Mitigation Measures	Parameter / Indicator of Compliance	Monitoring Frequency	Implementation Agency	Monitoring Agency	Estimated Cost
		<ul style="list-style-type: none"> <li>○ Provision of a sampling port for thermal water (heated cooling water) at appropriate and accessible location along the cooling water line.</li> </ul>					
Additional Baseline Data Gathering	Inaccurate predicted impacts and proposed measures due to lack of robust baseline will lead to unforeseen environmental pollution or damage.	<ul style="list-style-type: none"> <li>● During the detailed design phase of the project, the baseline survey shall be conducted to include monthly (air quality) and quarterly (marine water quality and underwater ecology survey) baseline data. In particular, the DBO Contractor shall:               <ul style="list-style-type: none"> <li>○ Undertake ambient air quality measurements (monthly), marine water quality analysis, and marine underwater ecology survey (quarterly) on first year after DBO contractor mobilization, at the identified sampling locations in the EIA report (and any other locations in and around Thilafushi island as may be deemed by the DBO Contractor as important sampling locations);</li> <li>○ follow required sampling methodologies, including appropriate averaging time for ambient air quality measurements as indicated in the WHO Ambient Air Quality Guidelines; and</li> <li>○ include results of analyses in the updating of the EIA,</li> </ul> </li> </ul>	<p>Results of monthly ambient air quality measurements (TSP, PM<sub>10</sub>, PM<sub>2.5</sub>, SO<sub>x</sub>, NO<sub>x</sub>).</p> <p>Results of quarterly marine water quality analysis (to follow parameters used in the first sampling activities).</p> <p>Results of quarterly marine underwater ecology survey (to follow parameters, methodologies and locations used in the first set of surveys in the EIA process).</p>	Monthly sampling (air quality) and quarterly sampling (marine water quality and underwater ecology survey) for minimum of 1 year after DBO contractor mobilization (to establish baseline conditions prior to works).	DBO Contractor	PMU	Part of DBO contract

Field or Activity	Potential Impact / Issue	Mitigation Measures	Parameter / Indicator of Compliance	Monitoring Frequency	Implementation Agency	Monitoring Agency	Estimated Cost
		and consider these results in the final detailed design of the project as applicable.					
<b>Construction Stage</b>							
<b>Physical Characteristics</b>							
Overall project site management	Poor environmental management by DBO Contractor	<ul style="list-style-type: none"> <li>Designate one full time and qualified Environment, Health and Safety (EHS) Manager who will be in charge of overall EMP implementation and other tasks as required in the EIA report. He/She shall be in place from the day of mobilization of DBO contractor.</li> <li>In addition to the EHS Manager, designate one qualified trained engineer on EHs and EMP/SEMP implementation for every shift during construction stage who will assist the EHS Manager (either in his/her presence or absence) at all times.</li> <li>Coordinate with the PMU on confirmatory surveys determined during design stage that need to be conducted once the DBO Contractor is selected; and complete these studies as required with support of external experts.</li> </ul>	<ul style="list-style-type: none"> <li>Included in manpower requirements as indicated in bidding documents and final contract documents.</li> <li>Hired EHS Manager and selected engineers trained on EHS and EMP/SEMP implementation based on required qualifications.</li> </ul>	One-off during mobilization, and continuously throughout the contract period	DBO Contractor	PMU	Part of DBO contract
Marine Traffic	Port congestion at Thilafushi due to transport of construction equipment and raw materials at site	<ul style="list-style-type: none"> <li>Avoid using the docking ports used by the local people and industries in Thilafushi when transporting construction heavy equipment and raw materials at the site.</li> <li>Transport and unload heavy equipment and raw materials at nighttime when marine traffic is</li> </ul>	<ul style="list-style-type: none"> <li>No disturbance to normal day-to-day movement of locals at the port and in the island.</li> </ul>	At least quarterly and reported by DBO Contractor	DBO Contractor	PMU	Part of DBO contract

Field or Activity	Potential Impact / Issue	Mitigation Measures	Parameter / Indicator of Compliance	Monitoring Frequency	Implementation Agency	Monitoring Agency	Estimated Cost
		<p>low within and around the island.</p> <ul style="list-style-type: none"> <li>Utilize the exclusive docking port area being used by WAMCO.</li> </ul>					
Topography landforms, geology, and soils and river morphology and hydrology	Raw materials for construction (e.g. sand, gravel or crushed stone) will be extracted from sources causing changes in topography and landforms (if on land such as other islands in Maldives) or river morphology and hydrology (if on the river in other countries).	<ul style="list-style-type: none"> <li>Utilize readily available sources with environmental clearance and license.</li> <li>Borrow areas and quarries comply with environmental requirements.</li> <li>Coordinate with local authorities for quarrying at various parts of Maldives where these raw materials are sourced. Alternative sources should be identified.</li> </ul>	Records of sources of materials	At least quarterly and reported by DBO Contractor	DBO Contractor	PMU	Part of DBO contract
Marine water quality	Trenching and excavation, run-off from stockpiled materials and chemical contamination from fuels and lubricants may result to silt-laden runoff during rainfall, which may cause siltation	<ul style="list-style-type: none"> <li>Implement spoils management plan.</li> <li>Reuse excess spoils and materials.</li> <li>Temporary storage areas for excess spoils prior to disposal should be located as far as possible from the edge of the island or seawalls.</li> <li>Disposal site in designated areas only.</li> <li>Earthworks during dry season. Avoid earthworks during heavy rainy days, especially during</li> </ul>	<ul style="list-style-type: none"> <li>Areas for stockpile storage of fuels and lubricants and waste materials;</li> <li>Number of silt traps installed along trenches leading to water bodies;</li> <li>No visible degradation to nearby drainage, water bodies due</li> </ul>	At least quarterly for both visual inspections and water quality sampling, and results reported by DBO Contractor to PMU.	DBO Contractor	PMU	Part of DBO contract

Field or Activity	Potential Impact / Issue	Mitigation Measures	Parameter / Indicator of Compliance	Monitoring Frequency	Implementation Agency	Monitoring Agency	Estimated Cost
	and degradation in the quality of marine water around Thilafushi.	<p>monsoon season, to prevent run-off.</p> <ul style="list-style-type: none"> <li>• Stockyards are covered when possible and provided with drainage canals around.</li> <li>• Install temporary silt traps or sedimentation basins along drainage leading to the lagoon and sea.</li> <li>• Fuel, other petroleum products, and toxic and hazardous chemicals or substances stored at storage areas away from water drainage and protected by impermeable lining and bunded 110%.</li> <li>• Take precautions to minimize the overuse of water</li> <li>• Divert all wash water generated from site into sedimentation ponds prior to discharge to canals.</li> <li>• During excavations, water accumulation in the pits / should be disposed of only after being diverted in sedimentation basis or equivalent and clarified prior to discharge.</li> <li>• Conduct water quality monitoring at least quarterly or as necessary.</li> </ul>	<p>to construction activities</p> <ul style="list-style-type: none"> <li>• Marine water quality testing</li> </ul>				
Air quality	Work at the dry season and transporting construction materials may increase dust, carbon, monoxide, sulfur oxides, particulate	<ul style="list-style-type: none"> <li>• Use of physical controls such as water sprays, covers, compaction, screening, enclosure, windbreakers, binders and/or road surfacing to avoid or minimize airborne dust from construction activities and vehicle movements. Undertake water spraying several times of the day or as often as needed</li> </ul>	<ul style="list-style-type: none"> <li>• Location of stockpiles.</li> <li>• Number of complaints from sensitive receptors.</li> <li>• Heavy equipment and machinery with air pollution control devices.</li> </ul>	At least quarterly and reported by DBO Contractor	DBO Contractor	PMU	Part of DBO contract

Field or Activity	Potential Impact / Issue	Mitigation Measures	Parameter / Indicator of Compliance	Monitoring Frequency	Implementation Agency	Monitoring Agency	Estimated Cost
	matter, nitrous oxides, and hydrocarbons in air environment	<p>especially on windy days / dry seasons.</p> <ul style="list-style-type: none"> <li>• Cover delivery trucks during transport.</li> <li>• Construction vehicle's speed limited to 30 kilometers per hour (kph).</li> <li>• Prohibition of open burning of solid waste.</li> <li>• Minimize stockpile height.</li> <li>• If dust generation is significant, provide a dust screen of appropriate height</li> <li>• Workers and staff should be provided with dust masks &amp; instructed to use them on site</li> <li>• Conduct work in stages to reduce dust impacts; clearing and then conducting construction in only a portion of the site at a time.</li> <li>• Control access to work area, prevent unnecessary movement of vehicles, workers, public trespassing into work areas; limiting soil disturbance will minimize dust generation</li> <li>• Contractor's environmental manager should monitor these activities and take action to apply the mitigation if dust production becomes significant.</li> <li>• Use tarpaulins to cover loose material (soil, sand, aggregate) when transported by trucks</li> <li>• Clean wheels and undercarriage of haul trucks prior to leaving construction site/quarry</li> <li>• Stabilize surface soils where loaders, support equipment and</li> </ul>	<ul style="list-style-type: none"> <li>• A certification that vehicles are compliant with Maldives vehicle emission standards.</li> <li>• Ambient air quality tests.</li> </ul>				

Field or Activity	Potential Impact / Issue	Mitigation Measures	Parameter / Indicator of Compliance	Monitoring Frequency	Implementation Agency	Monitoring Agency	Estimated Cost
		<p>vehicles will operate by using water and maintain surface soils in a stabilized condition</p> <ul style="list-style-type: none"> <li>• Ensure that all the construction equipment, machinery is fitted with pollution control devices, which are operating correctly.</li> <li>• Ensure that only those vehicles and equipment in good condition, and are in good maintenance are used for project construction</li> <li>• Vehicles / equipment should have a valid permits or licenses issued by relevant government agency.</li> <li>• Maintain record of these permits or licenses of all vehicles at all times for ready inspection at the work sites.</li> </ul>					
	<p>Degradation of ambient air due to operations of concrete batching plant.</p>	<ul style="list-style-type: none"> <li>• Ensure that batching plant is installed with built-in air pollution and dust control system for fugitive emissions and dust from loading area.</li> <li>• Provide dust screen around the components that generate emissions or fugitive dusts.</li> <li>• Ensure that plant is well operated and maintained at all times according to O&amp;M manual of batching plant (provided by the equipment manufacturer).</li> <li>• The concrete loading area is equipped with a leak-proof concrete floor, from which all drainage is collected and treated as necessary prior to discharge.</li> <li>• Mixer trucks and mixer drums are washed out only in a</li> </ul>	<ul style="list-style-type: none"> <li>• Visual inspection.</li> <li>• Visual inspection report.</li> </ul>	<p>Daily or as necessary and reported by DBO Contractor</p>	<p>DBO Contractor</p>	<p>PMU</p>	<p>Part of DBO contract</p>

Field or Activity	Potential Impact / Issue	Mitigation Measures	Parameter / Indicator of Compliance	Monitoring Frequency	Implementation Agency	Monitoring Agency	Estimated Cost
		<p>designated area, which should be equipped with a leak-proof floor, from which drainage is collected and treated as necessary.</p> <ul style="list-style-type: none"> <li>All chemicals used in concrete preparation are properly stored, whether dry, in powder or granular form, or as liquids, at storage areas away from water drainage and protected by impermeable lining and banded 110%. Storage facilities should be as specified in the appropriate international standard and should include equipment to extract dust and completely contain any spillage from leaks.</li> </ul>					
Acoustic environment	Temporary increase in noise level and vibrations by excavation equipment, and the transportation of materials, equipment and people.	<ul style="list-style-type: none"> <li>Prepare work schedule and consult with local community and administration.</li> <li>Maintain low noise levels. Noise level at the boundary of site shall not exceed 70 dB(A) during day and 50 dB(A) during night unless necessary to carry out construction works.</li> <li>When possible, schedule noisy works at nighttime when most establishments in Thilafushi are closed. Minimize any high noise-generating activities during the daytime.</li> <li>Use low noise generating equipment. Use modern vehicles and machinery with low noise emissions. Minimize noise from construction equipment by using vehicle silencers, fitting jackhammers with noise-</li> </ul>	<ul style="list-style-type: none"> <li>Number of complaints from sensitive receptors;</li> <li>Use of silencers in noise-producing equipment</li> <li>Use of sound barriers or enclosures for generators, if any;</li> <li>Noise level measured at daytime and nighttime at pre-determined locations at site.</li> </ul>	At least quarterly noise level measurement and reported by DBO Contractor	DBO Contractor	PMU	Part of DBO Contractor cost.

Field or Activity	Potential Impact / Issue	Mitigation Measures	Parameter / Indicator of Compliance	Monitoring Frequency	Implementation Agency	Monitoring Agency	Estimated Cost
		<p>reducing mufflers, and use portable street barriers to minimize sound impact to surrounding sensitive receptor.</p> <ul style="list-style-type: none"> <li>• Minimize drop heights for construction materials.</li> <li>• No use of horns unless necessary.</li> <li>• Avoid loud random noise from sirens, air compression, etc.</li> <li>• Avoid using multiple high noise generating equipment and activities simultaneously.</li> <li>• Install temporary or portable acoustic barriers around stationary construction noise sources.</li> <li>• Warning signs in noise hazard areas.</li> <li>• Identify vibration risk to nearby structures. Take caution working in such areas.</li> <li>• Conduct noise level monitoring at least every quarter or as necessary.</li> </ul>					
Aesthetics	Indiscriminate disposal of solid waste (construction and domestic) around the site. Interference with the enjoyment of the area and creation of unsightly or offensive conditions	<ul style="list-style-type: none"> <li>• Prepare and implement a Construction Waste Management Plan (CWMP) to identify specific steps on handling and disposal of all solid waste from construction activities, including the following: <ul style="list-style-type: none"> <li>○ Reuse as much waste sand in this project as possible;</li> <li>○ Finding alternative beneficial uses for any unused sand, for example as infill in other construction works;</li> </ul> </li> </ul>	<ul style="list-style-type: none"> <li>• Number of complaints from sensitive receptors;</li> <li>• Worksite clear of all types of wastes</li> <li>• Worksite clear of any wastes unutilized materials, and debris</li> <li>• Transport route and worksite cleared of dirt</li> </ul>	Daily or as necessary and reported by DBO Contractor	DBO Contractor	PMU	Part of DBO Contractor cost.



Field or Activity	Potential Impact / Issue	Mitigation Measures	Parameter / Indicator of Compliance	Monitoring Frequency	Implementation Agency	Monitoring Agency	Estimated Cost
		<ul style="list-style-type: none"> <li>○ Disposal of debris and bulky solid waste materials after construction stage.</li> <li>○ Minimizing stockpile size.</li> <li>○ Clearing wastes regularly.</li> <li>○ Avoiding stockpiling of excess spoils.</li> <li>○ Covering delivery trucks during transportation.</li> <li>○ Cleaning roads.</li> <li>○ Using screening enclosure shade cloth, temporary walls around construction site.</li> <li>○ Cleaning site regularly.</li> <li>○ Following the principle of “Reduce, Reuse, Recycle, and Recover”.</li> <li>● When applicable, solid wastes from the site shall be returned to the manufacturer of raw materials they were generated from, or dispose as per their specifications.</li> <li>● Hazardous waste shall be stabilized, encapsulated, and disposed as per internationally accepted practices. Provision will be made for secure storage of hazardous waste.</li> <li>● Residual and hazardous wastes such as oils, fuels, and lubricants shall be disposed of in approved disposal sites and/or third-party sources approved by Maldives EPA.</li> <li>● Prohibit burning of construction and/or domestic waste;</li> <li>● Ensure that wastes are not haphazardly thrown in and around the project site; provide proper collection bins, and</li> </ul>					

Field or Activity	Potential Impact / Issue	Mitigation Measures	Parameter / Indicator of Compliance	Monitoring Frequency	Implementation Agency	Monitoring Agency	Estimated Cost
		<p>create awareness to use the dust bins.</p> <ul style="list-style-type: none"> <li>Conduct site clearance and restoration to original condition after the completion of construction works.</li> </ul>					
<b>Biological Characteristics</b>							
Marine Biodiversity	Threat to marine and terrestrial species, or other marine animals due to (i) poaching or leisure catching by workers in the project area, and (ii) marine pollution.	<ul style="list-style-type: none"> <li>Implement the Marine and Beach Area Construction Work Plan.</li> <li>Implement the Erosion Control Plan for pipeline works.</li> <li>Ensure that all construction activities are conducted strictly within the site footprint (including offices, car parking and other activities that might normally be located in an exterior contractor's area).</li> <li>Prohibit any deliberate killing or harming of animals on or off-site; any hunting or fishing at the site or in nearby areas by site personnel; preventive actions shall be put in place by contractor for protected marine species.</li> <li>Ensure that all construction work or other activities near the site perimeter are conducted with particular care and include measures to reduce noise and dust to minimum possible.</li> <li>Create awareness in all site staff &amp; workers on the importance of the marine animals/species and plants around the site and their vulnerability.</li> <li>To protect site personnel, training should also be provided</li> </ul>	<ul style="list-style-type: none"> <li>Visual site inspection.</li> <li>Visual site inspection reports.</li> <li>Marine water quality tests.</li> <li>Marine and Beach Area Construction Work Plan</li> <li>Erosion Control Plan for pipeline works</li> <li>Spill Control and Containment Plan</li> </ul>	<p>Daily or as necessary for visual inspection and reported by DBO Contractor</p> <p>At least quarterly for marine water quality testing and reported by DBO Contractor</p>	DBO Contractor	PMU	Part of DBO Contractor cost.

Field or Activity	Potential Impact / Issue	Mitigation Measures	Parameter / Indicator of Compliance	Monitoring Frequency	Implementation Agency	Monitoring Agency	Estimated Cost
		<p>to enable them to recognize, and deal safely and humanely with all animals that may be encountered.</p> <ul style="list-style-type: none"> <li>• Implement the Spill Control and Containment Plan.</li> <li>• Marine works should be scheduled to occur in the north east monsoon season when the sea conditions are calmer to limit the spread of sediment around this operation.</li> <li>• Conduct the excavation, and deposit the excavated material in a more controlled manner minimizing the area that is disturbed.</li> <li>• Avoid the need to re-excavate by choosing right time (calmed sea conditions again), and quickly lowering the pipes into trench and refilling.</li> <li>• Limit the size of the construction area on the beach and to avoid any encroachment outside the specified area.</li> <li>• Monitor the turbidity &amp; DO levels due to spread of sediment throughout the trenching operation and work should be stopped if levels exceed pre-determined values as per the guideline below:               <ul style="list-style-type: none"> <li>○ The turbidity of the water is to be measured (ISO 7027) at the edge of the construction zone during trenching and backfilling activities;</li> <li>○ When the turbidity exceeds the minimum of the</li> </ul> </li> </ul>					

Field or Activity	Potential Impact / Issue	Mitigation Measures	Parameter / Indicator of Compliance	Monitoring Frequency	Implementation Agency	Monitoring Agency	Estimated Cost
		background turbidity plus 20% or 100 NTU, the trenching is to cease until the turbidity returns to the background level plus 10%.					
<b>Socio-economic Characteristics</b>							
Existing provisions for pedestrians and other forms of transport	<p>Potential road closures due to construction activities.</p> <p>Hauling of construction materials and operation of equipment on-site can cause traffic problems.</p>	<ul style="list-style-type: none"> <li>• Implement the Traffic Management Plan that will elaborate the following: <ul style="list-style-type: none"> <li>○ Suitable transportation routes.</li> <li>○ Safe passage for vehicles and pedestrians.</li> <li>○ Temporary road diversions and for provision of traffic aids if transportation activities cannot be avoided during peak hours.</li> <li>○ Scheduling of material deliveries on low traffic hours, particularly at night time when most establishments in Thilafushi island are already closed.</li> </ul> </li> <li>• Erect and maintain barricades if required.</li> <li>• Consult with business and institutions for work schedules.</li> <li>• Erect display boards around strategic locations about nature, duration of construction and contact for complaints and/or issues about the project.</li> <li>• Complete quickly any work that is near adjacent establishments.</li> <li>• Restore damaged properties and utilities.</li> </ul>	<ul style="list-style-type: none"> <li>• Traffic Management Plan. Traffic route during construction works, including number of permanent signs, barricades, and flagmen on worksite;</li> <li>• Number of complaints from sensitive receptors;</li> <li>• Some signage placed at the subproject location.</li> <li>• Number of walkways, signage, and metal sheets placed at subproject location</li> </ul>	Prior to start of construction, and weekly or as necessary during construction stage, and reported by DBO Contractor	DBO contractor	PMU	Part of DBO Contractor cost.
Socioeconomic status	Staffing will be required during construction. This can result	<ul style="list-style-type: none"> <li>• Engage the local workforce. If not available in Thilafushi Island, engage workers from nearby islands including Malé if</li> </ul>	<ul style="list-style-type: none"> <li>• Employment records;</li> </ul>	Monthly or as necessary and reported	DBO Contractor	PMU	Part of DBO Contractor cost.

Field or Activity	Potential Impact / Issue	Mitigation Measures	Parameter / Indicator of Compliance	Monitoring Frequency	Implementation Agency	Monitoring Agency	Estimated Cost
	in an increase in local revenue.	available and sufficiently qualified. <ul style="list-style-type: none"> <li>Secure construction materials from local market, whenever available.</li> </ul>	<ul style="list-style-type: none"> <li>Records of sources of materials</li> <li>Records of compliance with labor act of Maldives.</li> </ul>	by DBO Contractor			
Other amenities for community welfare	Civil works may result in an impact to the sensitive receptors such as residents, businesses, and the communities. Excavation may also damage infrastructure located alongside the roads.	<ul style="list-style-type: none"> <li>Before any excavation work, reconfirm location and nature of existing infrastructure, if any, identified during detailed design stage.</li> <li>Minimize repeated disturbance to locals by integrating forms of infrastructures such as temporary safe walkways in areas with ongoing excavation works. Provide alternate routes in the area if necessary, to allow smooth movement of workers and vehicles in the area.</li> <li>Inform through continuous meaning consultations with local people about nature, duration and possible impacts of the construction and integrate their concerns.</li> <li>Promptly relocate infrastructure materials if found to be obstructing or disturbing free movement of local people.</li> <li>Take prior permission from local authority for water use.</li> <li>Restore damaged properties and utilities to pre-work conditions.</li> </ul>	<ul style="list-style-type: none"> <li>Number of complaints from sensitive receptors</li> </ul>	Daily or as necessary and reported by DBO Contractor	DBO Contractor	PMU	Part of DBO Contractor cost.
Community health and safety	Construction works will impede the access of residents and	<ul style="list-style-type: none"> <li>Restrict work force in designated areas.</li> <li>Identify stockyard areas in consultation with local administration.</li> </ul>	<ul style="list-style-type: none"> <li>The number of permanent signs, barricades, and flagmen on worksites per</li> </ul>	Daily or as necessary and reported by DBO Contractor	DBO Contractor	PMU	Part of DBO Contractor cost.

Field or Activity	Potential Impact / Issue	Mitigation Measures	Parameter / Indicator of Compliance	Monitoring Frequency	Implementation Agency	Monitoring Agency	Estimated Cost
	business in limited cases. Construction works will raise danger to community people.	<ul style="list-style-type: none"> <li>• Work on private land to require written permission of landowners.</li> <li>• Prefer small mechanical excavator for excavation works.</li> <li>• Prohibit alcohol and drugs on site.</li> <li>• Prevent excessive noise.</li> <li>• Code of conduct for workers includes restricting workers in designated areas, no open defecation, no littering, no firewood collection, no fire except designated places, no trespassing, no residence at construction sites, and no obligation to potentially dangerous work.</li> <li>• Follow international best practices on community health and safety such as those in Section 4.3 of IFC Environmental Health and Safety (EHS) Guidelines on Construction and Decommissioning Activities. These requirements are discussed in Section VI of the EIA report.</li> <li>• Maintain a complaint logbook in workers camp and take action promptly of complaints.</li> </ul>	<p>Traffic Management Plan.</p> <ul style="list-style-type: none"> <li>• Number of complaints from sensitive receptors.</li> <li>• Number of walkways, signs, and metal sheets placed at the subproject location.</li> <li>• Agreement between contractor and WAMCO in case of using WAMCO's property for storage or use.</li> <li>• Agreement between contractor and private property owners in case of using the latter's land for storage and use.</li> </ul>				
Workers Health and Safety	There is invariably a safety risk when construction works such as excavation and earthmoving are conducted	<ul style="list-style-type: none"> <li>• Comply with labor act of Maldives.</li> <li>• Implement the Occupational Health and Safety Plan, which shall follow all occupational health and safety requirements discussed in Section VI of the EIA report.</li> </ul>	<ul style="list-style-type: none"> <li>• Occupational Health and Safety Plan</li> <li>• Equipped first-aid stations</li> <li>• Medical insurance coverage for workers</li> </ul>	Daily or as necessary and reported by DBO Contractor	DBO Contractor	PMU	Part of DBO Contractor cost.

Field or Activity	Potential Impact / Issue	Mitigation Measures	Parameter / Indicator of Compliance	Monitoring Frequency	Implementation Agency	Monitoring Agency	Estimated Cost
	<p>in urban areas. Workers need to be mindful of the occupational hazards, which can arise from working at height and excavation works.</p>	<ul style="list-style-type: none"> <li>• Provide compulsory health and safety orientation training to all new workers to ensure that they are apprised of Occupational Health and Safety Plan including rules of work, use of personal protective equipment (PPE), preventing injury to fellow workers, etc.</li> <li>• Restrict public access to worksites.</li> <li>• Provide PPE to workers and ensure their effective usage. For example, require workers to (i) wear ear plugs while in noise hazard areas, and (ii) wear high visibility clothes or reflectorized vests at all times.</li> <li>• Document procedures to be followed for site activities.</li> <li>• Maintain accident reports and records.</li> <li>• Make first aid kits readily available.</li> <li>• Maintain hygienic accommodation in work camps.</li> <li>• Ensure uncontaminated water for drinking, cooking and washing.</li> <li>• Ensure clean eating areas.</li> <li>• Ensure sanitation facilities are readily available.</li> <li>• Provide medical insurance coverage for workers.</li> <li>• Provide orientation for guest visitors.</li> <li>• Ensure that visitors do not enter hazard areas unescorted.</li> <li>• Ensure moving equipment is outfitted with audible backup alarms.</li> </ul>	<ul style="list-style-type: none"> <li>• Number of accidents</li> <li>• Records of supply of uncontaminated water</li> <li>• Condition of eating areas of workers</li> <li>• Record of orientation training</li> <li>• Availability of personal protective equipment at construction site</li> <li>• Percentage of moving equipment outfitted with audible back-up alarms</li> <li>• Signage for storage and disposal areas</li> <li>• Condition of sanitation facilities for workers</li> <li>• Report summary on daily toolbox talks for workers.</li> </ul>				

Field or Activity	Potential Impact / Issue	Mitigation Measures	Parameter / Indicator of Compliance	Monitoring Frequency	Implementation Agency	Monitoring Agency	Estimated Cost
		<ul style="list-style-type: none"> <li>• Chemical and material storage areas need to be marked clearly. Display MSDS, train staff on storage and handling.</li> <li>• Hearing protection equipment enforced in noisy environment.</li> <li>• Conduct of daily toolbox talks to reiterate repeatedly all the above measures and prioritize safety briefings; leanings from previous incidents, their causes and risks, and other safety procedures as may be identified.</li> <li>• Conduct periodic safety audit, identify and remove potential hazards.</li> <li>• Ensure that qualified first aid is provided at all times; equipped first-aid stations shall be easily accessible throughout the work sites and camps.</li> <li>• For works in the marine environment, ensure that: <ul style="list-style-type: none"> <li>○ all persons engaged in the marine construction are competent swimmers.</li> <li>○ Lifejackets are provided to workers and worn at all times.</li> <li>○ Properly functioning ship-to-shore communications are provided.</li> <li>○ No work during rough sea conditions.</li> <li>○ Emergency rescue team is available at all times at the site during the marine work (such as rescue boat with divers).</li> </ul> </li> </ul>					



Field or Activity	Potential Impact / Issue	Mitigation Measures	Parameter / Indicator of Compliance	Monitoring Frequency	Implementation Agency	Monitoring Agency	Estimated Cost
		<ul style="list-style-type: none"> <li>• Provide caution &amp; information boards (traffic, safety, information etc.,)</li> <li>• Do not allow unauthorized / public entry into work sites / facilities</li> <li>• Undertake all necessary public safety measures, precautions</li> <li>• Ensure proper maintenance and cleanliness of the site and facilities Demarcate assembly area for emergencies</li> <li>• Provide medical aid facilities (first aid, doctor on call etc.,)</li> </ul>					
Labor Camps	Indiscriminate environmental impact and pollution due to labor camps	<ul style="list-style-type: none"> <li>• Avoid establishing labor camps by employing local workers as far as possible.</li> <li>• In unavoidable cases, establish camp within the site; and implement the Construction Camp Development and Management Plan (CCDMP).</li> <li>• Follow the layout plan included in the CCMP.</li> <li>• The CCDMP will consider all construction camp requirements discussed in Section VI of the EIA report, which, among others, are the following:               <ul style="list-style-type: none"> <li>○ The camp, if possible in Thilafushi Island, is at least 50 m away from water bodies.</li> <li>○ Clear separation of the workers living areas from material storage areas and work sites with fencing and separate entry and exit</li> <li>○ Provision of proper liquid waste and solid waste</li> </ul> </li> </ul>	<ul style="list-style-type: none"> <li>• Visual inspection.</li> <li>• Visual inspection reports.</li> <li>• CCDMP</li> </ul>	Weekly and reported by DBO Contractor	DBO Contractor	PMU	Part of DBO Contractor cost.

Field or Activity	Potential Impact / Issue	Mitigation Measures	Parameter / Indicator of Compliance	Monitoring Frequency	Implementation Agency	Monitoring Agency	Estimated Cost
		collection, treatment and disposal system. o Provision of drinking water, water for other uses, and sanitation facilities (e.g. separate toilets for men and women). o Livability at the highest standards possible at all times; living quarters provided with standard materials, space, and proper lighting and ventilation. o Fire safety, medical facilities.					
<b>Post-Construction / Operation Stage</b>							
Overall project site management	Poor environmental management by DBO Contractor	<ul style="list-style-type: none"> <li>• Designate one full time and qualified Environment, Social, Health and Safety (EHS) Manager who will be in charge of overall EMP implementation and other tasks as required in the EIA report. He/She shall be in place from the day of mobilization of DBO contractor.</li> <li>• In addition to the EHS Manager, designate one qualified trained staff member on EHS and EMP/SEMP implementation for every shift who will assist the EHS Manager (either in his/her presence or absence) at all times.</li> <li>• Coordinate with the PMU on confirmatory surveys determined during the design stage that need to be conducted by the DBO Contractor during operation stage; and complete as required with support of external experts.</li> </ul>	<ul style="list-style-type: none"> <li>• Included in manpower requirements as indicated in bidding documents and final contract documents.</li> <li>• Hired EHS Manager and selected staff trained on EHS and EMP/SEMP implementation based on required qualifications.</li> <li>• Operation and Maintenance Manual</li> <li>• Waste Screening Procedure / Plan</li> <li>• Emergency and Disaster Preparedness and Response Plan</li> </ul>	One-off during mobilization, and continuously throughout the contract period, and reported by DBO Contractor	DBO Contractor	PMU	Part of DBO Contractor cost.

Field or Activity	Potential Impact / Issue	Mitigation Measures	Parameter / Indicator of Compliance	Monitoring Frequency	Implementation Agency	Monitoring Agency	Estimated Cost
		<ul style="list-style-type: none"> <li>• Implement the Operation and Maintenance Manual.</li> <li>• Implement Waste Screening Procedure / Plan to ensure all waste inputs to the facility comply with quantity and quality requirements, including accounting of hazardous / halogenated organic components in wastes</li> <li>• Implement the Emergency and Disaster Preparedness and Response Plan</li> </ul>					
<b>Physical Environment</b>							
Aesthetics	Indiscriminate disposal of solid waste (construction and domestic) around the site. Interference with the enjoyment of the area and creation of unsightly or offensive conditions	<ul style="list-style-type: none"> <li>• Implement the Solid Waste Management Plan for the operation of WTE facility to identify specific steps on handling and disposal of all solid wastes from the operation of the facility.</li> <li>• When applicable, solid wastes from the WTE plant shall be returned to the manufacturer of raw materials they were generated from, or dispose as per their specifications.</li> <li>• Hazardous waste shall be stabilized, encapsulated, and disposed as per internationally accepted practices. Provision will be made for secure storage of hazardous waste.</li> </ul>	<ul style="list-style-type: none"> <li>• Solid Waste Management Plan</li> <li>• Number of complaints from sensitive receptors;</li> <li>• Worksite clear of all types of wastes</li> <li>• Worksite clear of any wastes unutilized materials, and debris</li> <li>• Transport route and worksite cleared of dirt</li> </ul>	Daily or as necessary and reported by DBO Contractor	DBO Contractor	PMU	Part of DBO Contractor cost.
Air quality	Degradation of ambient air quality.	<ul style="list-style-type: none"> <li>• Consult with local community to present the day-to-day operation of the WTE plant. This will enable locals learn about the operations and identify the potential sources and time/duration of emissions.</li> </ul>	<ul style="list-style-type: none"> <li>• Number of complaints from sensitive receptors.</li> <li>• Machineries with air pollution control devices.</li> </ul>	At least quarterly and reported by DBO Contractor	DBO Contractor	PMU	Part of DBO Contractor cost.

Field or Activity	Potential Impact / Issue	Mitigation Measures	Parameter / Indicator of Compliance	Monitoring Frequency	Implementation Agency	Monitoring Agency	Estimated Cost
		<ul style="list-style-type: none"> <li>• Ensure efficient functioning of the air pollution control device of the plant and CEMS.</li> <li>• Use of physical controls such as water sprays, several times of the day or as often as needed especially on windy days / dry seasons.</li> <li>• Greenery and plantation at the perimeter to help control dispersion of air pollutants. All plant species to be introduced shall be endemic or native species in Maldives. Avoid introduction of invasive alien species by following guidance reference document issued by the MOE;</li> <li>• Cover delivery trucks during transport.</li> <li>• Vehicle speed limited to 30 kilometers per hour (kph).</li> <li>• Prohibition of open burning of solid waste.</li> <li>• Vehicles / equipment should have a valid permits or licenses issued by relevant government agency.</li> <li>• Maintain record of these permits or licenses of all vehicles at all times for ready inspection at the work sites.</li> </ul>	<ul style="list-style-type: none"> <li>• A certification that vehicles are compliant with Maldives vehicle emission standards.</li> <li>• Ambient air quality tests.</li> <li>• Stack emission tests.</li> <li>• CEMS real time print reports.</li> </ul>				
Marine water quality	Degradation in the quality of marine water around Thilafushi due to discharge of effluent from the WTE plant.	<ul style="list-style-type: none"> <li>• Ensure efficient and continuous functioning of the leachate treatment plant.</li> <li>• Stockyards are covered when possible and provided with drainage canals around.</li> <li>• Install temporary silt traps or sedimentation basins along</li> </ul>	<ul style="list-style-type: none"> <li>• Areas for stockpile storage of fuels and lubricants and waste materials;</li> <li>• Number of silt traps installed along trenches leading to water bodies;</li> </ul>	At least quarterly for both visual inspections and water quality sampling, and results reported by	DBO Contractor	PMU	Part of DBO Contractor cost.

Field or Activity	Potential Impact / Issue	Mitigation Measures	Parameter / Indicator of Compliance	Monitoring Frequency	Implementation Agency	Monitoring Agency	Estimated Cost
		<p>drainage leading to the lagoon and sea.</p> <ul style="list-style-type: none"> <li>Fuel, other petroleum products, and toxic and hazardous chemicals or substances stored at storage areas away from water drainage and protected by impermeable lining and bunded 110%.</li> <li>Divert all wash water generated from site into sedimentation ponds prior to discharge to canals.</li> <li>Conduct treated leachate water quality monitoring at least quarterly or as necessary.</li> </ul>	<ul style="list-style-type: none"> <li>No visible degradation to nearby drainage, water bodies.</li> <li>Marine water quality tests</li> <li>Effluent water quality tests.</li> <li>Thermal water temperature tests.</li> </ul>	DBO Contractor to PMU.			
Acoustic environment	Noise pollution due to plant operations.	<ul style="list-style-type: none"> <li>Consult with local community to present the day-to-day operation of the WTE plant. This will enable locals learn about the operations and identify the potential sources and time/duration of noise generation.</li> <li>Maintain low noise levels. Noise level at the boundary of site shall not exceed 70 dB(A) during day and 50 dB(A) during night.</li> <li>Use low noise generating equipment. Use modern vehicles and machinery with low noise emissions.</li> <li>No use of horns unless necessary.</li> <li>Avoid loud random noise from sirens (except sirens for emergency alarms), air compression, etc.</li> </ul>	<ul style="list-style-type: none"> <li>Number of complaints from sensitive receptors;</li> <li>Use of silencers in noise-producing equipment</li> <li>Use of sound barriers or enclosures for generators, if any;</li> <li>Noise level measured at daytime and nighttime at pre-determined locations at site.</li> </ul>	At least quarterly noise level measurement and reported by DBO Contractor	DBO Contractor	PMU	Part of DBO Contractor cost.

Field or Activity	Potential Impact / Issue	Mitigation Measures	Parameter / Indicator of Compliance	Monitoring Frequency	Implementation Agency	Monitoring Agency	Estimated Cost
		<ul style="list-style-type: none"> <li>• Avoid using multiple high noise generating equipment and activities simultaneously.</li> <li>• Install temporary or portable acoustic barriers around stationary machineries (e.g. generator sets).</li> <li>• Warning signs in noise hazard areas.</li> <li>• Conduct noise level monitoring at least every quarter or as necessary.</li> </ul>					
<b>Biological Characteristics</b>							
Biodiversity	Threat to marine species or animals due to unmanaged or mismanaged cooling water intake infrastructures	<ul style="list-style-type: none"> <li>• Implement the Spill Control and Containment Plan</li> <li>• Ensure that intake is operated as per the design</li> <li>• Conduct monitoring of marine species infringed in the intakes. Undertake corrective measures if required.</li> <li>• Proper handling of live aquatic organisms (fishes, crabs, turtles etc.) that enter intake and trapped at fine screen. Ensure to return these organisms or species back into the sea at locations away from the intake and outfall structures.</li> <li>• Wastes collected from the intake line and screens be disposed as per the internationally accepted procedures. These wastes shall not be mixed with brine for disposal or in the sea or by open dumping. They may be disposed as feed to the incinerator.</li> </ul>	<ul style="list-style-type: none"> <li>• Spill Control and Containment Plan</li> <li>• Inspection and incident reports, including photo documentations.</li> </ul>	Daily or as frequent as possible by DBO Contractor	DBO Contractor	PMU	Part of DBO Contractor cost.

Field or Activity	Potential Impact / Issue	Mitigation Measures	Parameter / Indicator of Compliance	Monitoring Frequency	Implementation Agency	Monitoring Agency	Estimated Cost
	Threat to marine species or animals due to unmanaged or mismanaged thermal water (heated cooling water) discharge.	<ul style="list-style-type: none"> <li>• Ensure cooling water system and condenser system of the WTE plant operate at designed efficiency.</li> <li>• Ensure to maintain the mandatory temperature required for thermal water (heated cooling water) being discharged to the sea.</li> <li>• Maintain the thermal water (heated cooling water) discharge flowrate as per design.</li> <li>• Conduct temperature monitoring of thermal water (heated cooling water) on a daily basis or as necessary.</li> </ul>	<ul style="list-style-type: none"> <li>• Inspection and temperature monitoring reports.</li> </ul>	Daily or as frequent as possible by DBO Contractor	DBO Contractor	PMU	Part of DBO Contractor cost.
<b>Socio-Economic Characteristics</b>							
Marine Traffic	Port congestion at Thilafushi due to delivery of solid wastes.	<ul style="list-style-type: none"> <li>• Continuing coordination with WAMCO to ensure use of the exclusive berth or docking port area for waste delivery at all times.</li> </ul>	<ul style="list-style-type: none"> <li>• Complaints from locals due to disturbance to normal day-to-day movement of locals at the port and in the island.</li> <li>• Visual inspection reports.</li> </ul>	At least quarterly and reported by DBO Contractor	DBO Contractor	PMU	Part of DBO Contractor cost.
Workers Health and Safety	There is invariably a safety risk to workers, occupational hazards, which can arise from working within and around the WTE Plant.	<ul style="list-style-type: none"> <li>• Comply with labor act of Maldives.</li> <li>• Implement the Occupational Health and Safety Plan.</li> <li>• Provide compulsory health and safety orientation training to all new workers to ensure that they are apprised of Occupational Health and Safety Plan including rules of work, use of personal protective equipment (PPE), preventing injury to fellow workers, etc.</li> </ul>	<ul style="list-style-type: none"> <li>• Occupational Health and Safety Plan</li> <li>• Equipped first-aid stations</li> <li>• Medical insurance coverage for workers</li> <li>• Number of accidents</li> <li>• Records of supply of uncontaminated water</li> </ul>	Daily or as necessary and reported by DBO Contractor	DBO Contractor	PMU	Part of DBO Contractor cost.

Field or Activity	Potential Impact / Issue	Mitigation Measures	Parameter / Indicator of Compliance	Monitoring Frequency	Implementation Agency	Monitoring Agency	Estimated Cost
		<ul style="list-style-type: none"> <li>• Restrict public access to the WTE Plant.</li> <li>• Provide PPE to workers and ensure their effective usage. For example, require workers to (i) wear ear plugs while in noise hazard areas, and (ii) wear high visibility clothes or reflectorized vests at all times.</li> <li>• Document procedures to be followed for site activities.</li> <li>• Maintain accident reports and records.</li> <li>• Make first aid kits readily available.</li> <li>• Maintain hygienic accommodation in workers accommodation or camps.</li> <li>• Ensure uncontaminated water for drinking, cooking and washing.</li> <li>• Ensure clean eating areas.</li> <li>• Ensure sanitation facilities are readily available.</li> <li>• Provide medical insurance coverage for workers.</li> <li>• Provide orientation for guest visitors.</li> <li>• Ensure that visitors do not enter hazard areas unescorted.</li> <li>• Ensure moving equipment is outfitted with audible backup alarms.</li> <li>• Chemical and material storage areas need to be marked clearly. Display MSDS, train staff on storage and handling.</li> <li>• Hearing protection equipment enforced in noisy environment.</li> <li>• Conduct of daily toolbox talks to reiterate repeatedly all the</li> </ul>	<ul style="list-style-type: none"> <li>• Condition of eating areas of workers</li> <li>• Record of orientation training</li> <li>• Availability of personal protective equipment at construction site</li> <li>• Percentage of moving equipment outfitted with audible back-up alarms</li> <li>• Signage for storage and disposal areas</li> <li>• Condition of sanitation facilities for workers</li> <li>• Report summary on daily toolbox talks for workers.</li> </ul>				



Field or Activity	Potential Impact / Issue	Mitigation Measures	Parameter / Indicator of Compliance	Monitoring Frequency	Implementation Agency	Monitoring Agency	Estimated Cost
		<p>above measures and prioritize safety briefings; leanings from previous incidents, their causes and risks, and other safety procedures as may be identified.</p> <ul style="list-style-type: none"> <li>• Conduct periodic safety audit, identify and remove potential hazards.</li> <li>• Ensure that qualified first aid is provided at all times; equipped first-aid stations shall be easily accessible throughout the work sites and camps.</li> <li>• For maintenance works in the marine environment, ensure that:               <ul style="list-style-type: none"> <li>○ all persons engaged in the marine construction are competent swimmers.</li> <li>○ Lifejackets are provided to workers and worn at all times.</li> <li>○ Properly functioning ship-to-shore communications are provided.</li> <li>○ No work during rough sea conditions.</li> <li>○ Emergency rescue team is available at all times at the site during the marine work (such as rescue boat with divers).</li> </ul> </li> <li>• Provide caution &amp; information boards (traffic, safety, information etc.,)</li> <li>• Do not allow unauthorized / public entry into WTE Plant.</li> <li>• Undertake all necessary public safety measures, precautions</li> </ul>					

<b>Field or Activity</b>	<b>Potential Impact / Issue</b>	<b>Mitigation Measures</b>	<b>Parameter / Indicator of Compliance</b>	<b>Monitoring Frequency</b>	<b>Implementation Agency</b>	<b>Monitoring Agency</b>	<b>Estimated Cost</b>
		<ul style="list-style-type: none"><li>• Ensure proper maintenance and cleanliness of the site and facilities Demarcate assembly area for emergencies</li><li>• Provide medical aid facilities (first aid, doctor on call etc.)</li></ul>					

#### **D. Environmental Monitoring Plan**

535. Monitoring is the systematic collection of information over a long period of time. It involves the measuring and recording of environmental variables associated with the development impacts. Monitoring is needed to:

- (i) Compare predicted and actual impacts;
- (ii) Assess the effectiveness of mitigation measures;
- (iii) Obtain information about responses of receptors to impacts;
- (iv) Enforce and ensure legal standards and statutory requirements are complied with;
- (v) Prevent and take remedial measures for negative environmental issues resulting from inaccurate predictions;
- (vi) Minimize errors in future assessments and impact predictions;
- (vii) Make future assessments more efficient;
- (viii) Provide information for environmentally responsible project management; and
- (ix) Improve the EIA and monitoring process.

536. Impact and mitigation monitoring will be carried out to compare predicted and actual impacts occurring from project activities and determine the efficiency of the mitigation measures. This type of monitoring will be targeted at assessing project-related impacts on the physical and biological resources, economic development, and/or socio-cultural resources including communities surrounding the project site.

537. Table 54 below show the environmental monitoring plan (EMOP) covering the construction and operational phases of the project. Costs for the monitoring activities shall be borne by either the DBO Contractor or PMU depending on whose responsibilities these activities are as indicated in the EMP.

**Table 54: Environmental Monitoring Plan**

Activity	Location	Parameters to be Monitored	Means of Monitoring	Frequency	Implementation Responsibility
<b>Construction Stage</b>					
Ambient air quality sampling and monitoring	Pre-identified monitoring stations at Thilafushi Island (the same sampling locations as during baseline data gathering).  Other additional location/s as may be needed and identified during construction stage.	TSP, PM <sub>10</sub> , PM <sub>2.5</sub> , SO <sub>x</sub> , NO <sub>x</sub>	Mandatory ambient air quality monitoring using appropriate instruments; and Visual inspection	Quarterly (24-hour at sampling locations used during baseline data gathering)	DBO Contractor to implement monitoring activity (PMU to check compliance)
Noise level monitoring	West side boundary (nearest establishments) of the WTE plant (the same locations as used during baseline data gathering).  Other additional pre-identified noise level monitoring site/s at Thilafushi Island.	Day time and nighttime noise levels dB(A)	Ambient noise level monitoring equipment	Once prior to start of construction works (both day time and night time);  Once during conduct heavy construction work expected to generate high noise level (either or both day time and night time, depending on when such heavy construction work is undertaken);  Monthly during normal construction activities (both day	DBO Contractor to implement monitoring activity (PMU to check compliance)

<b>Activity</b>	<b>Location</b>	<b>Parameters to be Monitored</b>	<b>Means of Monitoring</b>	<b>Frequency</b>	<b>Implementation Responsibility</b>
				time and night time)	
Marine water quality monitoring	Pre-identified sampling locations at the northern and southern sides of the construction site (same sampling points as used during baseline data gathering).	BOD, DO, TSS, Oil and Grease, Fecal Coliform	Grab sampling at northern and southern sea sides relative to the location of construction site.	Once every quarter	DBO Contractor to implement monitoring activity (PMU to check compliance)
Groundwater quality monitoring	Pre-identified sampling wells, as used during baseline data gathering.	Oil and Grease, Fecal Coliform, Presence of petroleum and other chemicals use in the baseline data.	Grab sampling from deep wells.	Once every quarter	DBO Contractor to implement monitoring activity (PMU to check compliance)
Condition of disposal areas	All designated disposal areas	General condition of area, estimated capacity of disposed spoils, estimated remaining capacity that can be accommodated.	Visual inspection,  Actual measurements in the area.	Weekly or monthly depending on the frequency of spoil disposal	DBO Contractor to implement monitoring activity (PMU to check compliance)
Condition at construction camp sites	Construction camp site.	All good housekeeping practices as specified in the EMP.	Visual inspection, Interview with occupants.	Weekly	DBO Contractor to implement monitoring activity (PMU to check compliance)
Assessment of occupational health and safety measure implementation	(i) Construction work site; and (ii) Construction camp site.	All occupation health and safety measures as specified in the EMP	Visual inspection, Interview with workers at sites and occupants at camp sites	Weekly	DBO Contractor to implement monitoring activity (PMU to check compliance)
Assessment of community health and safety measure implementation	Vicinity of construction work site and around Thilafushi Island.	All community health and safety measures as specified in the EMP	Visual inspection, Interview with locals.	Weekly	DBO Contractor to implement monitoring activity (PMU to check compliance)
Construction of cooling water lines, intake, and discharge points.	Construction site and previously identified alignment	Exact locations if complying with pre-approved and	Visual inspections.	Continuous as the construction	DBO Contractor to implement monitoring

Activity	Location	Parameters to be Monitored	Means of Monitoring	Frequency	Implementation Responsibility
	and location of cooling water lines, intake location and outfall location.	recommended locations per EIA report.		progresses (by DBO Contractor).  Random inspection by PMU but at least once a week.	activity (PMU to check compliance)
<b>Post-Construction</b>					
Demobilization of construction heavy equipment	Construction site	Schedule of transport of heavy equipment to ensure no disruption or disturbance to marine traffic around Thilafushi Island.	Schedule of demobilization Visual inspection	Continuing or as needed during the demobilization activities.	DBO Contractor to implement monitoring activity (PMU to check compliance)
Site clearing	Construction site	Types of construction wastes remaining at site.  Disposal site of remaining construction wastes.	Visual inspection of wastes and location of disposal site.	Continuing or as needed during the site clearing activities.	DBO Contractor to implement monitoring activity (PMU to check compliance)
<b>Operation Stage</b>					
Stack emission sampling and monitoring.	Stack sampling ports	TSP, SO <sub>x</sub> , NO <sub>x</sub> , Organic Carbon, CO, HCl, HF, Hg and its compounds, NH <sub>3</sub> , Cd, As, Dioxins/Furans, sum of heavy metals and their compounds.	Mandatory stack emission sampling using appropriate instruments.  Mandatory emission monitoring through CEMS.  Visual inspection.	At least annually for stack emission sampling.  Continuous monitoring through installed CEMS.  Daily visual monitoring	DBO Contractor to implement monitoring activity (PMU to check compliance)
Ambient air quality sampling and monitoring	Pre-identified monitoring stations at Thilafushi Island (the same sampling locations as during baseline data gathering).	TSP, PM <sub>10</sub> , PM <sub>2.5</sub> , SO <sub>x</sub> , NO <sub>x</sub>	Mandatory ambient air quality monitoring using appropriate instruments; and Visual inspection end	Once every quarterly at the identified baseline sampling locations	DBO Contractor to implement monitoring activity (PMU to check compliance)

Activity	Location	Parameters to be Monitored	Means of Monitoring	Frequency	Implementation Responsibility
	Other additional location/s as may be needed and identified during operation stage.				
Noise level monitoring	<p>West side boundary (nearest establishments) of the WTE plant (the same locations as used during baseline data gathering).</p> <p>Other additional pre-identified noise level monitoring site/s at Thilafushi Island.</p>	Day time and nighttime noise levels dB(A)	Ambient noise level monitoring equipment	<p>Once prior to start of operations (both day time and night time);</p> <p>Once every time generator set is utilized (either or both day time and night time, depending on when the generator set/s is/are used);</p> <p>Monthly during normal operating conditions (both day time and night time)</p>	DBO Contractor to implement monitoring activity (PMU to check compliance)
Marine water quality monitoring	Pre-identified sampling locations at the northern and southern sides of the WTE site (same sampling points as used during baseline data gathering).	BOD, DO, TSS, Oil and Grease, Fecal Coliform	Grab sampling at northern and southern sea sides relative to the location of WTE site.	Once every quarter	DBO Contractor to implement monitoring activity (PMU to check compliance)
Effluent quality sampling and monitoring	Effluent sampling ports of leachate treatment plant and wastewater treatment plant	COD, BOD5, Total Inorganic Nitrogen, Nitrate, Sulfur, Phosphorus, Lead, Cadmium, Chromium, Hexavalent	Mandatory effluent quality monitoring using appropriate instruments; and Visual inspection	Monthly (grab sampling) Daily (visual)	DBO Contractor to implement monitoring activity (PMU to check compliance)

Activity	Location	Parameters to be Monitored	Means of Monitoring	Frequency	Implementation Responsibility
		Chromium, Mercury, Nickel, Zinc, Copper, Arsenic			
Cooling water discharge monitoring	Sampling port along thermal water discharge line	Temperature, Physical condition surrounding the outfall location	On the spot/ on-site temperature monitoring using appropriate instruments; and  Visual inspection (through diving activity) to monitor the vicinity of the outfall	Daily or as frequent as necessary by DBO Contractor  Once every quarter	DBO Contractor to implement monitoring activity (PMU to check compliance)
Groundwater quality monitoring	Pre-identified sampling wells, as used during baseline data gathering.	Oil and Grease, Fecal Coliform, Presence of petroleum and other chemicals.	Grab sampling from deep wells.	Once every quarter	DBO Contractor to implement monitoring activity (PMU to check compliance)
Condition at WTE workers accommodation, if any.	Workers accommodation.	All good housekeeping practices as specified in the EMP.	Visual inspection, Interview with occupants.	Weekly	DBO Contractor to implement monitoring activity (PMU to check compliance)
Assessment of occupational health and safety measure implementation	WTE plant	All occupation health and safety measures as specified in the EMP	Visual inspection, Interview with workers at WTE plant.	Weekly	DBO Contractor to implement monitoring activity (PMU to check compliance)
Assessment of community health and safety measure implementation	Vicinity of WTE plant and around Thilafushi Island.	All community health and safety measures as specified in the EMP	Visual inspection, Interview with locals.	Weekly	DBO Contractor to implement monitoring activity (PMU to check compliance)



Figure 131: Recommended Ambient Air Quality Monitoring Stations in Thilafushi Island



## **E. Reporting**

538. **DBO Contractor.** The DBO Contractor will be required to submit monthly monitoring reports to PMU during the implementation phase of the project. PMU may require DBO Contractor submit any additional information and reports that will be needed to fulfill the reporting obligation of MOE to ADB and Maldives EPA.

539. **PMU Reporting to ADB.** PMU will prepare and submit reports to ADB and Maldives EPA. PMU will prepare reports to be sent to ADB on a quarterly basis during construction phase and semiannual basis during the operation phase. Semiannual reports during operation are to be prepared and submitted until ADB issues a project completion report. The suggested outline of quarterly environmental monitoring reports is attached as Appendix 12. To facilitate monitoring and enable responses to emerging issues, monthly reports will be prepared by the PMU.

540. **PMU Reporting to Maldives EPA.** PMU will likewise prepare and submit reports to Maldives EPA as required by the schedule and report structure shown in Environmental Impact Assessment Guidelines by Maldives EPA. A detailed environmental monitoring report is to be compiled and submitted to the Maldives EPA on the format provided in the Maldives EPA's Environmental Impact Assessment Guidelines, following monitoring activities at each stage.

541. The monitoring report shall include details of the site, means of data collection and analysis, quality control measures, sampling frequency and monitoring analysis and details of methodologies and protocols followed.

542. Currently, Maldives does not have specific set of national standards for monitoring waste to energy plants. Hence an attempt could be made during the environmental monitoring stage to compare the performance of the environmental monitoring program with internationally recognized standards using the baseline that had been established with this study.

## **F. Cost of EMP Implementation**

543. **Table 53** shows that most of the mitigation measures proposed by this EIA study comprise activities that are standard practice on most modern construction sites (e.g., preparing and implementing a site EHS Plan, planning access routes to avoid sensitive areas, etc.). Even the less commonly encountered measures (e.g., limiting the size construction areas to reduce ecological damage, conducting hot water outfall construction in calm conditions to limit the spread of disturbed sediment, etc.) would not be unusual for contractors who are used to working in similar environments. Most of the mitigation specified by this EMP therefore requires normal or good site practice and applies construction standards to which an experienced international contractor would work as a matter of course. The costs of these mitigation measures will therefore be covered by the DBO Contractor's normal budget estimates for project design, construction and operation. Indicative cost estimated for EMP implementation and monitoring activities are included in the EIA report and DBO bid documents. The exact and more specific budget for EMP implementation, monitoring, capacity development, and other safeguards requirements will be determined once the DBO contractor is on board and will be included in the Final EIA report.

544. However, there are some measures that contractors would not normally budget for, and these are the measures that are required because of the unique aspects of this project site. These include ecological marine surveys of coral reef to collect data and plan mitigation for the at-risk of marine environment; data collection and revised numerical modeling studies; turbidity monitoring

to reduce the spread of suspended sediment; and longer-term monitoring of the impacts of the project on marine benthos and fish.

545. The estimated cost of these activities is shown in Table 55 below. These based on the cost of similar exercises on other projects in Maldives and elsewhere. This shows that the total cost of implementing those aspects of the EMP that will not be covered by standard budgets for plant design, construction and operation. These costs would be included in bidding documents, and DBO Contractor can provide budget and quote in the budget as per the requirement of EMP in bidding document towards environmental surveys and social and environmental awards campaigns.

**Table 55: Costs of the Monitoring Program<sup>a</sup>**

Description	Total (\$)
<b>1. Design Stage</b>	
Confirmatory surveys (protected/rare species of flora, fauna)	50,000
Green buffer zone	30,000
Numerical Modeling	50,000
Preparation of various plans suggested in the EMP	45,000
<b>2. Construction Stage</b>	
Environment & ecological monitoring	100,000
replantation of trees	50,000
<b>3. Operation Stage</b>	
Environmental Monitoring	50,000
<b>4. Implementation support</b>	
External environmental expert, supervision, monitoring etc.	150,000
<b>Total</b>	<b>525,000</b>

<sup>a</sup> These are only the costs that are not normally covered in standard budget line items of a BOQ.

## **G. Future Review and Revision of Documents**

546. This EIA was conducted in the pre-tender period based on feasibility study and preliminary design. Guidance on potential approaches to construction and operation was obtained from experienced engineers and solid waste management experts, and descriptions of the likely construction and operation processes were prepared accordingly, adopting the basic operational parameters provided by the feasibility study and draft tender documents for the DBO contract. Potential impacts of the project were assessed on the basis of these descriptions and with the aid of primary baseline data on the existing environmental conditions gathered at the project site and its surroundings, secondary information obtained from published literature, and new data from surveys conducted during the EIA process.

547. The EIA report and EMP will be updated at detailed design stage and revisited at key stages throughout the project and will be updated at each stage to reflect any changes in design or approach, and to amend the impact assessment and mitigation and monitoring proposals as may be necessary. This process will also allow any unforeseen impacts to be documented, mitigated and monitored. The EIA report will be reviewed and updated, if necessary, by the DBO Contractor at the following key stages:

- (i) after finalization of designs;
- (ii) during construction (months 6 and 18);
- (iii) at the end of facility commissioning (i.e. before operations begin); and
- (iv) at the end of the first and second years of facility operation.

548. The review and revision process will be conducted by the DBO Contractor with the assistance of the external environmental expert hired under the project, and to be reviewed and approved by the Maldives EPA. It should be emphasized that it may not be necessary to revise the document at each stage, as this should only be done to address significant deviations from what is presented in this EIA report or its latest version in the future.

549. If there will be significant changes in the final detailed design compared to the preliminary design used in the EIA and/or if during the detailed design phase there will be identified associated facilities relative to the project per definition of ADB SPS, the DBO Contractor shall update the EIA report, including the EMP and EMOP, accordingly. The DBO Contractor shall submit the updated EIA report to PMU, and the PMU shall submit the updated EIA report to ADB for final review and disclosure.

## **X. CONCLUSION AND RECOMMENDATIONS**

550. The EIA of GMWEP has been prepared based on review of technical specifications of the project as included in the DBO bid documents, primary and secondary information of the site and its surroundings. The overall findings of this EIA are:

- (i) The project will result in significant environmental benefits because the current condition in Thilafushi and the project area will be improved;
- (ii) During construction, the project will not have significant adverse environmental impacts and potential adverse impacts are manageable through the effective implementation of the EMP;
- (iii) During operations, the project will have potential impacts on ambient air quality, marine water quality, marine ecology, noise, and occupational and community health and safety. However, with the performance guarantees required to be complied by the DBO contractor, significant impacts are avoided, and residual impacts can be mitigated by measures specified in the EMP; and
- (iv) No social impacts pertaining to land loss, land fragmentation, physical displacement, loss of income, loss of productive land, potential income loss for fishermen and preventing fishing-related activities and fishing routes.

551. In view of the results of the studies undertaken in this EIA, following are the major recommendations that DBO Contractor shall undertake:

- (i) Engage external expert(s) for verification of environmental monitoring reports and EMP implementation. External expert(s) are not involved in day-to-day project implementation or supervision;
- (ii) Establish the ambient air quality monitoring stations in Thilafushi and Villingili as identified in the AUSTAL2000 and AERMOD air dispersion modeling studies and utilize these stations for monitoring activities during the operation phase as indicated in the environmental monitoring plan. The proposed locations are in Figure 127;
- (iii) Conduct validation modeling during the starting months of normal operation of the WTE plant using actual CEMS and stack testing results to simulate actual operation of the plant;
- (iv) Conduct validation of the thermal dispersion model during the starting months of normal operation of the WTE plant using actual temperatures taken within the thermal plume as described in MIKE 21 model and CORMIX;

- (v) Install the cooling water discharge line at section M8 and position the outfall of the discharge line at a distance of 70 meters from the shoreline and 30 meters deep from the sea surface. See

- (vi) Figure 15;
- (vii) Install the intake of the cooling water line at the vicinity of M1-M8. Ensure that position of the inlet opening is at minimum distance of 15 meters from the outfall and away from the direction of the cooling water jet plume. See Figure 24; and
- (viii) Continuous monitoring around Thilfushi island to confirm the extent of biodiversity in various seasons of the year, including assessment of features pertinent to critical habitats. This is to ensure pre-construction works conditions and biodiversity risks are considered in the design, construction and operation, and to examine and mitigate the potential impacts of the project on areas significant for biodiversity.

552. Mitigation measures during operation phase are described in the EMP of this EIA report. Apart from all the mitigation measures in the EMP, the following are further recommendations that DBO Contractor shall consider:

- (i) A system with controlled burning and a good air pollution control system should be included in the WTE plant design;
- (ii) Incinerator with a stack height of minimum 45.7 m (per air dispersion modeling calculations) to reduce the impacts of air pollutants on the surrounding environment. Increasing this height further will be more favorable;
- (iii) Environmental and occupational health and safety procedures for all processes should be established and enforced;
- (iv) There should be strict inspection and testing during the installation of the HDPE membrane (or similar) and the various protective / drainage layers for the landfill;
- (v) Preventive measures should be implemented to avoid loss of waste during transport and loading / off-loading;
- (vi) There should be appropriate sanitation facilities and workshops (for machinery), as well as secure storage facilities for fuel and chemicals, including toxic and hazardous wastes;
- (vii) Boilers should be regularly maintained, while structures such as the stacks and ducts should be regularly checked to avoid fugitive dusts sources and particulate accumulation;
- (viii) Control devices such as the Dry Scrubber and Baghouse should undergo regular checkup and maintenance;
- (ix) Solid wastes should have acceptance criteria in terms of waste characteristics;
- (x) Periodic watering of roads to minimize generation and resuspension of dust particles;
- (xi) Greenery and plantation at the perimeter or buffer areas to serve as vegetation walls that can help control dispersion of air pollutants. All plant species to be introduced shall be a known species that thrive in Thilafushi or Maldives. If necessary, the DBO Contractor shall obtain permission from relevant agency of the government to ensure such plant is endemic or native species in Maldives;
- (xii) Ensure to follow the government policy on preventing introduction of invasive alien species in the island. In particular, DBO Contractor to use as reference the guidance issued by the MOE attached as Appendix 13;
- (xiii) Regular ambient air quality monitoring should be conducted in hotspots and impact areas based on the results of the modeling report. Actual ambient monitoring may be treated as validation of model results; and
- (xiv) Every modification and installation of new sources should be considered as additional contribution to emission of the plant. Hence, modeling updates should also be conducted to determine assimilative carrying capacity of the area based on the impacts of the new modification or installation.



## **XI. ACKNOWLEDGEMENTS**

Water Solutions acknowledge the support and assistance of the following team members who made this project a successful project.

- Ahmed Jameel, Environmental Engineer and EIA Consultant (EIA Registration No: EIA P07/2007)
- Abdul Aleem, Environment Consultant and Marine Environment Specialist
- Ahmed Fazeel, Junior Environmental Consultant (EIA Consultant Registration number: EIA T01/2019)
- Ibrahim Faiz (EIA Consultant Registration number: EIA P05/2017)
- Mohamed Umaru, Junior Environmental Consultant (EIA Registration No: EIA P06/2017)
- Nashfa Nashidh, Junior Environmental Consultant
- Fathmath Inash Adil, Civil and Marine Engineer
- Faruhath Jameel, Chief Surveyor (National Building Practitioners Registration Number: BP02406)
- Mohamed Affan Shakir, Hydrographic Surveyor (National Building Practitioners Registration Number: BP09218)
- Hamdhulla Shakeeb, Survey Specialist



## XII. REFERENCES

- AECOM (2011) Engineering Investigation and Environmental Studies for Integrated Waste Management Facilities or managing municipal solid waste (MSW) Hong Kong
- Council Directive 1999/31/EC of 26 April 1999 on the Landfill of Waste
- DI (2015), Soil testing on Reclamation - Hulhumalé Phase 2 Development Dredging and Reclamation Works, Dredging International NV, Malé.
- Directive 2010/75/EU of the European Parliament and the Council (Technical Provisions Relating to emission standards for waste incineration plants and waste co-incineration plants any time). EU Industrial Emission Directives (IED).
- Kylefors, K. (2002) Predictions of Leaching from Municipal Solid Waste (MSW) and Measures to Improve Leachate Management at Landfills, Doctoral Thesis, Department of Environmental Engineering, Lulea University of Technology, Sweden.
- Hay, J. E. (2006). Climate Risk Profile for the Maldives. Malé, Maldives: Ministry of Environment and Energy and Water.
- Jameel, A. (2007). Developing a Disaster Profile for Maldives, A thesis for the master's degree. Christchurch, New Zealand: University of Canterbury.
- Jiang, X.Q., Mei, X.D., and Feng, D. (2016) Air Pollution and Chronic Air Way Diseases: What should people know and do? *Journal of Thoracic Disorders*, 8, E31-E40.
- Johnson, C.A, Richner, G.A., Vitvar, T., Schittle, N., and Eberhard, M. (2008) Hydrological and geochemical factors affecting leachate composition in MSW incinerator bottom ash. Part 1; The Hydrology of Landfill, Lostorf, Switzerland
- Maniku, H. A. (1990) Changes in the Topography of the Maldives, Forum of Writers on Environment (Maldives), Malé
- MEE (2018). Feasibility Study for an Integrated Solid Waste Management System for Zone 3 (including Greater Malé) and Design of the Regional Waste Management Facility at Thilafushi, Ministry of Environment and Energy.
- MEE (2017) EIA for the Proposed Reclamation of Thilafalhu for the establishment of the Regional Waste Management Facility for Zone 3, Kaafu Atoll, Ministry of Environment and Energy, Malé.
- MEE (2017) EMP for the establishment of Island Waste Management Center in L. Hithadhoo, Ministry of Environment and Energy and Energy, Malé.
- MEE (2017) State of the Environment 2016, Ministry of Environment and Energy and Energy
- MEE (2017) Environment & Social Assessment & Management Framework Climate Change Adaptation Project (MEE, 2014) Ministry of Environment and Energy and Energy, Malé.
- MEE (2016) Second National Communication of the Maldives to the United Nations Framework Convention on Climate Change, Ministry of Environment and Energy and Energy, Malé
- MEE, (2015) Development of High-resolution Regional Climate Model for the Maldives, Ministry of Environment and Energy, Malé, Maldives
- MEE (2014) Environment & Social Assessment & Management Framework Climate Change Adaptation Project, Ministry of Environment and Energy and Energy, Malé.
- MEE, (2013), Guidance Manual for Climate Risk Resilient Coastal Protection in the Maldives, Ministry of Environment and Energy and Energy, Maldives
- Ministry of Housing, Transport and Environment (2009), Third National Environment Action Plan, Ministry of Housing, Transport and Environment, Malé, Maldives
- MEE (2012) Environmental and Social Impact Assessment for North Regional Waste Management Facility Construction and Operation (MEE, 2012), Ministry of Environment and Energy and Energy, Malé.
- MEE (2012) ESIA for Construction and Operation North Regional Waste Management Facility at R. Vandhoo (MEE, 2012) Ministry of Environment and Energy and Energy, Malé.
- MEE (2011), EIA for the proposed solid waste management facility at Thilafushi, Kaafu Atoll Maldives, Ministry of Environment and Energy and Energy, Malé.

- MEEW (2005) State of the Environment of the Maldives 2004, Ministry of Environment and Energy, Energy and Water, Malé
- MHAHE (2001) First National Communication of the Maldives to the United Nations Framework Convention on Climate Change, Ministry of Home Affairs, Housing and Environment, Malé
- MPND (2005a) National Recovery and Reconstruction Plan, Ministry of Planning and National Development, Malé
- Woodroffe, C. D. (1989) Maldives and Sea Level Rise: An Environmental Perspective, University of Wollongong, Wollongong
- Naseer, A. & Hatcher, B. G. (2004) Inventory of the Maldives' coral reefs using morphometrics generated from Landsat ETM+ imagery. *Coral Reefs*, 23, 161-168.
- UNDP (2006) Developing a Disaster Risk Profile of the Maldives, UNDP, Malé, Maldives
- UNEP (2002) State of the Environment (SOE) report, Maldives, United Nations Environment Program.
- Water Solutions Pvt. Ltd, (2008). Maps of Maldives, the complete guide to the Atolls and Islands of Maldives. Malé: Water Solutions Pvt. Ltd, Maldives
- Woodroffe, C. D. (1992) Morphology and evolution of reef islands in the Maldives Seventh International Coral Reef Symposium, 1217 - 1226

## Rapid Environmental Assessment (REA) Checklist

### Instructions:

- (i) The project team completes this checklist to support the environmental classification of a project. It is to be attached to the environmental categorization form and submitted to the Environment and Safeguards Division (SDES) for endorsement by the Director, SDES and for approval by the Chief Compliance Officer.
- (ii) This checklist focuses on environmental issues and concerns. To ensure that social dimensions are adequately considered, refer also to ADB's (a) checklists on involuntary resettlement and Indigenous Peoples; (b) poverty reduction handbook; (c) staff guide to consultation and participation; and (d) gender checklists.
- (iii) Answer the questions assuming the "without mitigation" case. The purpose is to identify potential impacts. Use the "remarks" section to discuss any anticipated mitigation measures.

**Country/Project Title:** MLD / Greater Malé Waste-to-Energy Project

**Sector Division:** SAUW

Screening Questions	Yes	No	Remarks
A. Project Siting Is the project area...			The WTE project will be located in Thilafushi, an island on the southern rim of North Malé atoll, and on the eastern line of atolls within the archipelago. Thilafushi is an island classified as industrial zone and about 9.5km from Malé, the capital city of Maldives. In terms of geographic coordinates, Thilafushi is located at 04° 11' 00" N and 73° 26' 44" E.
▪ Densely populated?		✓	The island is classified as industrial island with no residential area. Population density is low. Baseline socio-economic profile shows there are no communities in Thilafushi. It is estimated that there 140 companies and less than 1,500 workers in the whole island.
▪ Heavy with development activities?		✓	Most locators in the island do not engage in heavy development activities. Survey shows that most establishments are warehouses and workshops only.
▪ Adjacent to or within any environmentally sensitive areas?			
○ Cultural heritage site		✓	Not applicable. No cultural heritage site in the island.
○ Protected Area	✓		The project site is located near 3 protected areas (Lions Head – 1 km away; Hans Hass – 2 km away; and Kuda Haa – 5 km away). Assessment of likely impacts of the project to these protected areas has been included in the EIA.
○ Wetland		✓	Not applicable. No wetland in and around the island.
○ Mangrove		✓	Not applicable. No mangrove in and around the island.

Screening Questions	Yes	No	Remarks
o Estuarine		✓	Not applicable. No estuarine in and around the island.
o Buffer zone of protected area		✓	Not applicable. No buffer zone in and around the island.
o Special area for protecting biodiversity		✓	Not applicable. Apart from the protected areas mentioned above, there is no other special area for protecting biodiversity in and around the island.
o Bay		✓	The island is situated within a large atoll (Kaafu Atoll). The project site is bordered by marine waters on its northern and southern boundaries. However, these coastal/marine waters are not regarded as sensitive or protected areas.
B. Potential Environmental Impacts Will the Project cause...			
▪ impacts associated with transport of wastes to the disposal site or treatment facility		✓	Not applicable. The project does not include component associated with transport of wastes.
▪ impairment of historical/cultural monuments/areas and loss/damage to these sites?		✓	There are no historical or cultural monuments in Thilafushi Island.
▪ degradation of aesthetic and property value loss?		✓	<b>Not anticipated.</b> The project will improve the existing situation in Thilafushi Island.
▪ nuisance to neighboring areas due to foul odor and influx of insects, rodents, etc.?		✓	<b>Not anticipated.</b> The current condition (dumpsite and unscientific waste management) will significantly improve due to the closing down and eventual rehabilitation of the existing dumpsite.
▪ dislocation or involuntary resettlement of people?		✓	<b>Not applicable.</b> The project will not cause or involve dislocation and involuntary resettlement of people.
▪ disproportionate impacts on the poor, women and children, Indigenous Peoples or other vulnerable groups?		✓	<b>Not applicable.</b> The project site is a newly built site in an industrial island (with no displaced humans or residential areas). The island is also not a host to any indigenous peoples or vulnerable groups.
▪ risks and vulnerabilities related occupational health and safety (OSH) due to physical, chemical, biological, and radiological hazards during project construction and operation?	✓		<b>Anticipated during construction and operation phases.</b> OHS risks are inherent to construction activities and WTE plant operations. These impacts will be mitigated by measures in the EMP and bidding documents following internationally recognized best practices and standards, such as the World Bank EHS Guidelines on Construction and Decommissioning Activities, and Guidelines on Waste Management Facilities.
▪ public health hazards from odor, smoke from fire, and diseases transmitted by flies, insects, birds and rats?		✓	<b>Not anticipated.</b> The project will improve the existing situation in Thilafushi Island.

Screening Questions	Yes	No	Remarks
<ul style="list-style-type: none"> <li>deterioration of water quality as a result of contamination of receiving waters by leachate from land disposal system?</li> </ul>	✓		<b>Anticipated during operation.</b> The project includes a residual wastes landfill that will accommodate bottom ash and fly ash. The residual waste landfill cells may produce leachates that could potentially impact water quality of groundwater and marine waters. As measure included in the EMP and bidding documents, the landfill cells will be designed following internationally recognized best practices and standards for bottom ash/fly ash landfills to ensure no leachate will seep into the ground or flow out to the marine waters surrounding the project site.
<ul style="list-style-type: none"> <li>contamination of ground and/or surface water by leach ate from land disposal system?</li> </ul>	✓		<b>Anticipated during operation.</b> The residual wastes landfill may produce leachates that could potentially impact water quality of groundwater and marine waters. However, as measure included in the EMP and bidding documents, the landfill cells will be designed following internationally recognized best practices and standards for bottom ash/fly ash landfills to ensure no leachate will seep into the ground or flow out to the marine waters surrounding the project site.
<ul style="list-style-type: none"> <li>land use conflicts?</li> </ul>		✓	<b>Not applicable.</b> The project will utilize land that has been newly developed for the purpose.
<ul style="list-style-type: none"> <li>pollution of surface and ground water from leachate coming from sanitary landfill sites or methane gas produced from decomposition of solid wastes in the absence of air, which could enter the aquifer or escape through soil fissures at places far from the landfill site?</li> </ul>		✓	<b>Not anticipated.</b> The project does not include any solid waste landfilling. During operation phase of the WTE plant, wastes that will be used as buffer will be baled and stored in storage areas protected with flooring and linings that will prevent seepage of leachate.
<ul style="list-style-type: none"> <li>inadequate buffer zone around landfill site to alleviate nuisances?</li> </ul>		✓	Buffer zone and greenery is included in the design for the WTE plant.
<ul style="list-style-type: none"> <li>road blocking and/or increased traffic during construction of facilities?</li> </ul>		✓	<b>Not anticipated.</b> The transport of construction materials will utilize an exclusive route being used by the government in transporting solid wastes to Thilafushi island. This route is different from the route being taken by locals, including private and commercial marine vehicles in the island.
<ul style="list-style-type: none"> <li>noise and dust from construction activities?</li> </ul>	✓		<b>Anticipated</b> , but duration is short-term, site-specific within a relatively small area. Measures to mitigate these impacts are included in the EMP and bidding documents following internationally recognized best practices and standards. Environmental monitoring is included in the EMP.
<ul style="list-style-type: none"> <li>temporary silt runoff due to construction?</li> </ul>	✓		<b>Anticipated</b> , but duration is short-term, site-specific within a relatively small area. Measures to mitigate this impact are included in the EMP and bidding documents following internationally recognized best practices and standards.
<ul style="list-style-type: none"> <li>hazards to public health due to inadequate management of landfill site caused by inadequate institutional and financial capabilities for the management of the landfill operation?</li> </ul>		✓	<b>Not applicable.</b> The project includes institutional and financial capabilities for the management of the facilities.

Screening Questions	Yes	No	Remarks
<ul style="list-style-type: none"> <li>emission of potentially toxic volatile organics from land disposal site?</li> </ul>	✓		<b>Anticipated.</b> The design of landfill for the bottom ash and fly ash includes cover and engineering measures to ensure no emissions of potentially toxic volatile organics.
<ul style="list-style-type: none"> <li>surface and ground water pollution from leachate and methane gas migration?</li> </ul>	✓		<b>Anticipated.</b> Leachate will be generated during operations. However, the leachate collection and treatment system will be lined to ensure groundwater and marine waters are not polluted. Generation of methane gas is not anticipated.
<ul style="list-style-type: none"> <li>loss of deep-rooted vegetation (e.g. trees) from landfill gas?</li> </ul>		✓	<b>Not applicable.</b> The project does not involve solid waste landfill operation.
<ul style="list-style-type: none"> <li>explosion of toxic response from accumulated landfill gas in buildings?</li> </ul>		✓	<b>Not applicable.</b> Generation of methane gas is not anticipated.
<ul style="list-style-type: none"> <li>contamination of air quality from incineration?</li> </ul>	✓		<b>Anticipated.</b> Air emission from the WTE plant will potentially contaminate the air and deteriorate ambient air quality in the island. However, this impact will be mitigated by the engineering design and requirements of the project. The DBO Contractor will be required to comply with a set of performance guarantees, which includes assurance that air emission will comply with internationally accepted emission standards for incinerator plants.
<ul style="list-style-type: none"> <li>public health hazards from odor, smoke from fire, and diseases transmitted by flies, rodents, insects and birds, etc.?</li> </ul>		✓	<b>Not anticipated.</b> The project will improve the situation in Thilafushi Island. The shutting down of operation and eventual rehabilitation of the existing dumpsite will reduce the proliferation of disease vectors affecting the island and other nearby islands. During operation phase, the EMP will define measures to mitigate hazards following internationally recognized best practices and standards, such as the World Bank EHS Guidelines on Waste Management Facilities.
<ul style="list-style-type: none"> <li>health and safety hazards to workers from toxic gases and hazardous materials in the site?</li> </ul>	✓		<b>Anticipated during construction and operation phases.</b> The EMP includes measures to mitigate impacts, such as the mandatory use of personal protective equipment by workers. Regular training will also be conducted to ensure that workers are aware of construction hazards and risks of chemicals during O&M.
<ul style="list-style-type: none"> <li>large population influx during project construction and operation that causes increased burden on social infrastructure and services (such as water supply and sanitation systems)?</li> </ul>		✓	<b>Not anticipated.</b> Similar to workers of other industries in Thilafushi island, most workers of the project are expected to be residents of nearby islands such as Gulhi Fahlu, Villingili and Male. For workers who will be staying at the project site, the DBO Contractor will be required to establish a workers' camp with complete facilities.
<ul style="list-style-type: none"> <li>social conflicts if workers from other regions or countries are hired?</li> </ul>		✓	<b>Not anticipated.</b> Priority in employment will be given to local residents of Maldives. Workers from other regions or countries will be considered only if no counterpart expertise is available locally.

Screening Questions	Yes	No	Remarks
<ul style="list-style-type: none"> <li>▪ risks to community health and safety due to the transport, storage, and use and/or disposal of materials such as explosives, fuel and other chemicals during construction and operation?</li> </ul>	✓		<p><b>Anticipated.</b> Fuels and other chemicals will be used during the construction and operation of the WTE plant, and these may raise risks of explosions or fires at the site. However, the EMP will define measures to manage these risks, including the implementation of proper handling and storage of these chemicals, following internationally recognized best practices and standards, such as the World Bank EHS Guidelines on Construction and Decommissioning Activities, and Guidelines on Waste Management Facilities.</p>
<ul style="list-style-type: none"> <li>▪ community safety risks due to both accidental and natural hazards, especially where the structural elements or components (e.g., landfill or incinerator) of the project are accessible to members of the affected community or where their failure could result in injury to the community throughout project construction, operation and decommissioning?</li> </ul>	✓		<p><b>Anticipated.</b> These risks are potential in the operation of the WTE plant. However, the EMP will define measures in order to manage these risks based on internationally accepted best practices and standards, such as the EHS Guidelines on Waste Management Facilities. Operational area will be clearly demarcated and access will be controlled. Only workers and project concerned members will be allowed to visit the WTE plant site.</p>

## A CHECKLIST FOR PRELIMINARY CLIMATE RISK SCREENING

Screening Questions	Score	Remarks <sup>1</sup>
<b>Location and Design of project</b>	2	Project location is in an island in Maldives that will likely be affected by floods due to rains or sea level rise.
	2	Project location is in an island in Maldives that will likely be affected by floods due to rains or sea level rise. Therefore, the project design needs to consider the impact of flooding and sea level rise.
<b>Materials and Maintenance</b>	0	No significant effect
	0	No significant effect
<b>Performance of project outputs</b>	0	No significant effect

Options for answers and corresponding score are provided below:

Response	Score
Not Likely	0
Likely	1
Very Likely	2

Responses when added that provide a score of 0 will be considered low risk project. If adding all responses will result to a score of 1-4 and that no score of 2 was given to any single response, the project will be assigned a medium risk category. A total score of 5 or more (which include providing a score of 1 in all responses) or a 2 in any single response will be categorized as high risk project.

**Result of Initial Screening (Low, Medium, High): High Risk**

Prepared by:

*Ninette Pajarillaga*

**Ninette Pajarillaga, Environment Specialist, SAUW**

<sup>1</sup> If possible, provide details on the sensitivity of project components to climate conditions, such as how climate parameters are considered in design standards for infrastructure components, how changes in key climate parameters and sea level might affect the siting/routing of project, the selection of construction material and/or scheduling, performances and/or the maintenance cost/scheduling of project outputs.



**Compliance with Terms of Reference Issued by the Maldives Environmental Protection Agency for the Conduct of EIA for the WTE Plant.**

<b>Scope of work — The EIA shall include but not necessarily be limited to the following tasks:</b>	<b>Compliance</b>
<b>Task 1. Description of the Proposed Project</b>	
<ul style="list-style-type: none"> <li>• Describe the RWMF (incinerator &amp; ash disposal cells) and associated infrastructure (harbor, fuel storage, power supply etc.) to be developed including location, plant layout and its position using maps and drawings where appropriate.</li> <li>• Describe the current operational condition of Thilafushi, including the tonnage of waste received, method of waste management, operator of the facility, number of staff employed, and difficulties faced.</li> <li>• Describe the need and justification for the proposed facility and the methodology employed.</li> <li>• Provide detailed description of the proposed facilities. Describe the level of waste treatment that will occur.</li> <li>• Describe the methodology for air quality measurement.</li> <li>• Describe how hazardous waste are going to be processed.</li> <li>• Describe how electronic waste is going to be processed.</li> <li>• Describe how plastic is going to be processed.</li> <li>• Describe how all organic and inorganic waste is going to be processed.</li> <li>• Describe the steps involved from waste collection to transport to delivery to final location.</li> <li>• Describe the lessons learnt that was adopted from current operations at regional waste management facility at Vandh00.</li> <li>• Describe the operations of the RWMF including waste catchment area to be serviced by the facility, and waste type, volumes and composition to be received at the facility. Indicate the project life span,</li> <li>• Identify the emission releases likely to be of concern and the environmental aspects of the project area which may potentially be impacted by the proposal.</li> <li>• Describe the type of incinerator plant to be installed including specifications, performance characteristics and operational flow diagrams. Provide details of the ash disposal cells including capacity, dimensions, design specifications and phased development plans.</li> <li>• Describe the lifetime of the sanitary landfill site, for how many years is the sanitary landfill designed.</li> <li>• Provide requirements for new infrastructure to service the project such as water supply and sewerage infrastructure. Describe details of all equipment and vehicles that are going to be procured for the new operations.</li> <li>• Provide details of the amount of energy that will be generated from the waste to energy component and how it will be utilized.</li> </ul>	<p>Task 1 refers to various requirements covered under Phase 1 and Phase 2, including rehabilitation of the existing dumpsite.</p> <p>The draft EIA is intended to be submitted for the ADB approval process. Therefore, Section I and Section II of the draft EIA report discuss items related to the WTE Plant only. The draft EIA does not include detailed discussions on the activities under Phase 1 and rehabilitation of the existing dumpsite (although background information is included).</p> <p>Since the project will be awarded as a DBO contract, many of detailed information required are not completely described.</p> <p>In a separate submission to Maldives EPA, Ministry of Environment may submit additional document that would discuss compliance with the other</p>

<ul style="list-style-type: none"> <li>• Describe the model of management that will be adopted for the operations.</li> <li>• Justify the final elevation of structures (including as ash disposal cells) with reference to the height above the mean high tide, highest annual tides and risk of flood inundations during seasonal high tide regimes.</li> <li>• Describe the existing condition of the site and how Thilafushi is going to be restored.</li> <li>• Describe all project inputs and outputs. Including equipment and resources required both for construction and operational phase. Provide a detailed schedule of the project.</li> <li>• Describe how this project facilitates to achieve the 3R concept of waste management. That is reduce, reuse and recycle concept.</li> </ul>	<p>required items under Task 1.</p>
<p><b>Task 2. Description of the Environment</b> - Assemble, evaluate and present baseline data on the relevant environmental characteristics of the study area, focused on the marine, terrestrial and air environment. Aspects of the environment shall be described to the extent necessary for assessment of the environmental impacts of the proposed development. The extent and quality of the available data shall be characterized indicating significant information deficiencies and any uncertainties associated with the prediction of impacts.</p> <p>This section should provide details of the environment in the vicinity of the proposed development site. Data collection methodology used to describe the existing environment shall be detailed. All survey locations, sampling points, reef transects, vegetation transects, manta tows and soil sampling sites shall be referenced with Geographic Positioning System (GPS). All marine water samples shall be taken at a depth of 1m below the mean sea level or mid water depth for shallow areas. Baseline data collection shall focus on key issues needing to be examined for the EIA Consideration of likely monitoring requirements shall be borne in mind during survey planning, so that the data collected is suitable for use as a baseline for impacts monitoring.</p> <p>All available data from previous studies, if available shall be presented. Information required includes the following:</p>	<p>Compliance in Section V.</p>
<p><u>Physical environment:</u></p>	

- Describe the meteorology (rainfall, wind, waves and tides), sea currents, surface hydrology, climatic and oceanographic conditions in the area, and bathymetry of the hot-water outfall location.
- Describe the existing air quality within project site at Thilafushi and at the nearest islands. Ambient Air Quality measuring the following parameters: Particulate matter (PM10, PM2.5), Sulphur dioxide (SO2), Oxides of nitrogen (NOx), Methane (CH4), Carbon monoxide (CO), Cadmium (Cd), Lead (Pb), Mercury (Hg), Hydrocarbons (HCs). Measurements should be made from all locations from which data was taken in 2011 ELA report.
- Dispersion model for air pollution taking into account wind direction.
- Describe noise sources contributing to ambient noise levels (day/night) at the nearest and adjacent islands.
- Sensitive noise receptors adjacent to all project components shall be identified and typical background noise estimated based on surveys at representative sites. A justification for an ambient noise baseline (dBA) at the nearest and adjacent inhabited islands shall be provided. Ambient Noise should be measured from the facility location, harbor location and also from the waste transfer road location.
- An indication of the quality and quantity of water resources in the vicinity of the project site should be given including spatial and temporal monitoring to accurately characterize baseline groundwater characteristics and present water uses. Groundwater quality measuring following parameters pH, color, odor, turbidity, Electrical Conductivity, nitrate, phosphate, chloride, total dissolved solids, mercury, lead, arsenic, manganese, cadmium, iron, Total Coliform and polycyclic aromatic hydrocarbons. From all locations from which water quality was assessed in 2011 and from the reclaimed areas following 2011.
- Marine water quality should be assessed. The following parameters needs to be investigated. This includes Temperature, pH, salinity, Total Suspended Solids (TSS), phosphate, nitrate, ammonia, sulphate, Biological Oxygen Demand (BOD), Chemical Oxygen Demand (COD), Arsenic and Total Coliform. Assessment should be undertaken at all waste transfer routes and from locations from which data was taken in 2011 report.
- Currents data should be measured from the harbor and channel locations and from the lagoon. Comparisons should be made with the data collected from 2011 EIA report. Dispersion model of waste in water should be presented, taking into account currents.

Biological environment:

<ul style="list-style-type: none"> <li>• Description of the terrestrial environment of the site including current condition of the site,</li> <li>• Assessment of the marine environment should be undertaken from all locations from which data was taken in 2011 ELA report. This assessment should cover coral cover and fish census information.</li> <li>• Plankton Assessment from 5 different locations around Thilafushi.</li> <li>• Areas of special sensitivity including coral reefs and marine protected areas near Thilafushi shall be marked on a map and described. This shall include environmentally sensitive areas, protected areas and significant dive sites.</li> </ul>	
<u>Socio-cultural environment:</u>	
<ul style="list-style-type: none"> <li>• Describe the natural features and landscapes of the project site which may have a cultural significance.</li> <li>• Describe the visual amenity from the nearest and adjacent islands to Thilafushi.</li> <li>• Describe any Structures on the project site which may have cultural or religious significance.</li> <li>• Provide details of the land use plan in Thilafushi. This shall refer to current and future envisioned development projects.</li> </ul>	
<u>Hazard Vulnerability</u>	
<ul style="list-style-type: none"> <li>• Vulnerability of proposed project area to flooding and storm surges need be described.</li> </ul>	
<p><b>Task 3. Legislative and regulatory considerations</b> — Identify the pertinent legislation, regulations and standards, and environmental policies that are relevant and applicable to the proposed project, and identify the appropriate authority jurisdictions that applies to the project. Outline the pertinent policies, regulations and standards governing project location, land use, environmental quality, and public health and safety. Relevant sections of the regulations need to be highlighted and how the project complies with these sections indicated. Specific attention needs to be given to the waste management regulation and waste policy and how the project complies with these documents and how the relevant approvals will be attained.</p>	Compliance in Section III.
<p><b>Task 4. Determination of Potential impacts of proposed project</b> — Identify the major issues of environmental and social concern and indicate their relative importance to the design of the project. Distinguish construction and postconstruction phase impacts, significant positive and negative impacts, and direct and indirect impacts. Identify impacts that are cumulative, unavoidable or irreversible. Particular attention shall be given to impacts associated with the following:</p>	Compliance in Section VI.

<p><u>Site preparation, construction and commissioning:</u></p> <ul style="list-style-type: none"> <li>• RWMF construction impacts including a description of the relevant parts and nature of the works, an indicative construction timetable, including expected commissioning and start-up dates and hours of operation, and a description of major work programs for the construction phase, including an outline of construction methodologies.</li> <li>• Commissioning impacts — including a description of the regional waste management facility commissioning process.</li> </ul>	
<p><u>Incinerator operation:</u></p> <ul style="list-style-type: none"> <li>• Describe solid waste management activities during operations, with particular reference to waste collection, transport, sorting, incinerator loading, and disposal of incinerator ash.</li> <li>• Characteristics of any hazardous materials resulting from or involved in the project, indicating appropriate management strategies (e.g. handling, storage, treatment, disposal).</li> <li>• Provide an inventory of projected annual emissions for each relevant greenhouse gas, with total emissions expressed in 'CO2 equivalent' terms.</li> </ul>	
<p><u>Air Quality:</u></p> <ul style="list-style-type: none"> <li>• Characterize the nature of emissions to air likely to be produced during the incineration process including flue gas composition, volumes, expulsion height, ejection velocity and temperature.</li> <li>• Describe the pollution control equipment, techniques and the features of the incinerator designed to suppress or minimize emissions to air.</li> <li>• Air dispersion modelling outcomes which estimate the effect of the expected emissions from the proposed incinerator on ambient air quality within the air shed with particular reference to the nearest and adjacent islands. The air dispersion modelling exercise shall evaluate the extent and concentration of following pollutants which are typical constituents of solid waste combustion: sulfur dioxide, nitrogen oxides (as nitrogen dioxide), TSP, PM2.5 and PM 10. Air emissions shall be stated in respect stack and ground level concentrations, using a dispersion model.</li> </ul>	
<p><u>Ground Water</u></p> <ul style="list-style-type: none"> <li>• Provide details of potential impacts on the quality of ground and marine waters. Reference shall be made to leachate from ash disposal, the potential of wastewater to contaminate ground and marine water, and impact on current and future potential groundwater usage from the Thilafushi.</li> </ul>	

<ul style="list-style-type: none"> <li>Describe the pollution control equipment and design features of the proposed development for prevention and minimization of contamination of groundwater resources.</li> </ul>	
<u>Natural Environment</u>	
<ul style="list-style-type: none"> <li>The proximity of the facility to any sensitive areas shall be described. Describe measures to be taken to avoid and minimize potential adverse impacts of the proposal on sensitive terrestrial and aquatic environments.</li> <li>Describe potential issues relevant to sensitive areas, or areas which may have low resilience to environmental change arising from the construction, operation of the project including clearing, salvaging or removal of vegetation. Areas of special sensitivity include coral reefs, marine protected areas and communities. The capacity of the environment to assimilate discharges/emissions shall be assessed. Short-term and long-term effects shall be considered with comment on whether the impacts are reversible or irreversible. The discussion shall cover all likely direct and indirect environmental harm due to the project on flora and fauna particularly sensitive areas.</li> <li>If construction and operation of the project are likely to cause adverse impacts on sensitive areas or areas which may have low resilience to environmental change describe environmental offsets that would counterbalance the impact on these values.</li> </ul>	
<u>Noise Amenity,</u>	
<ul style="list-style-type: none"> <li>Describe the impacts of noise generated during the construction and operation of the proposed facility on nearest and adjacent islands. An analysis of noise impacts shall include the estimated noise levels generated by the proposed development assessed against typical background levels on the islands, and the impact of noise at all potentially sensitive receivers compared with an acceptable international standard.</li> <li>If noise is likely to cause an adverse impact propose measures to minimize or eliminate these effects, including details of any screening, lining, enclosing or bunding of facilities, or timing schedules for construction and operations.</li> </ul>	
<u>Socio-cultural:</u>	

<ul style="list-style-type: none"> <li>• Describe the impacts of the proposed development on the natural features and landscapes of the project site which may have socio - cultural significance. Use sketches, diagrams, elevation drawings to portray the near views and far views of the completed structures and their surroundings from visually sensitive locations.</li> <li>• Describe measures to be taken to avoid and minimize potential adverse impacts of the proposal on visual amenity. Justify the proposed development with particular reference to potential for visual amenity.</li> <li>• Describe the impact of the proposed development on any structures which may have cultural or religious significance. Describe measures to be taken to avoid, manage or mitigate potential impacts on these structures during construction and operation of the proposed development.</li> <li>• The methods used to identify the significance of the impacts shall be outlined. One or more of the following methods shall be utilized in determining impacts; checklists, matrices, overlays, networks, expert systems and professional judgment. Justification shall be provided to the selected methodologies. The report shall outline the uncertainties in impact prediction and also outline all positive and negative/short and long-term impacts. Identify impacts that are cumulative and unavoidable.</li> </ul>	
<p><b>Task 5. Alternatives to proposed project</b> — Describe alternatives including the "no action option" should be presented. Determine the best practical environmental options. Alternatives examined for the proposed project that would achieve the same objective including the "no action alternative" which represents current conditions.</p> <p>This section shall include a comparison of the technologies and methods for management and control of contaminants which may potentially impact on the environment including alternatives for ash disposal. All alternatives shall be compared according to international standards and commonly accepted standards as much as possible. Mitigation options shall be specified for each component of the proposed project.</p> <p>A cost benefit analysis needs to be presented in this section for the different alternative methods of waste management proposed. Analysis from environmental, social and economic perspective needs to be presented.</p>	<p>Compliance in Section IV</p>
<p><b>Task 6. Environmental Management Plan (mitigation 'monitoring)</b> — The Project's environmental management plan (EMP) shall consists of a set of mitigation, monitoring, and institutional measures to be taken during implementation and operation to eliminate adverse environmental and social impacts, offset them, or reduce them to acceptable levels. In cases where impacts are unavoidable</p>	<p>Compliance in Section IX. However, specific details on institutional arrangements are yet to be agreed upon between ADB and the</p>

<p>arrangements to compensate for the environmental effect shall be given. The plan shall include off-set measures if mitigation measures are not feasible, cost-effective, or sufficient. Specifically, the EMP shall:</p>	<p>Government of Maldives.</p>
<p><u>Mitigation and management of negative impacts</u></p>	
<ul style="list-style-type: none"> <li>• Identify and summarize all anticipated significant adverse environmental impacts (coral reef and marine environment, air and groundwater (as applicable));</li> <li>• Describe each mitigation measure, including the type of impact to which it relates and the conditions under which it is required, together with designs, equipment descriptions, and operating procedures, including: <ul style="list-style-type: none"> <li>- General operating procedures for managing and mitigation risks to the environment from general facility, operations including waste collection, transport, incinerator loading, hazardous waste handling, fuel, transfer and storage, litter management disposal of incinerator ash and residues,</li> <li>- Manufacturer's operational guidelines specifically outlining safety and emission control procedures as well, as recommended maintenance practices.</li> <li>- General operating procedures for implementing back-up measures that will act in the event of failure of primary measures to minimize the likelihood of adverse air impacts.</li> </ul> </li> <li>• Estimate any potential environmental impacts of these measures;</li> <li>• Provide linkage with any other mitigation plans required for the project.</li> </ul>	
<p><u>Monitoring</u></p>	
<ul style="list-style-type: none"> <li>• Provide (a) a specific description, and technical details, of monitoring measures, including the parameters to be measured, methods to be used, sampling locations, frequency of measurements, detection limits (where appropriate), and definition of thresholds that will signal the need for corrective actions; and (b) monitoring and reporting procedures to; <ul style="list-style-type: none"> <li>- (i) Ensure early detection of conditions that necessitate particular mitigation measures, and</li> <li>- (ii) Furnish information on the progress and results of mitigation. Specifically, the plan shall address physical groundwater quality, air emissions, coral reef and marine environment (as applicable).</li> </ul> </li> </ul>	
<p><u>Capacity Development and Training</u></p>	
<p>Specifically, the EMP shall provide a specific description of institutional arrangements who is responsible for carrying out the mitigation and monitoring measures (e.g., for operation, supervision,</p>	



<p>enforcement, monitoring of implementation, remedial action, financing, reporting, and staff training). EMP shall cover steps to strengthen environmental management capability in the agencies responsible for its implementation.</p>	
<p><u>Implementation Schedule and Cost Estimates</u></p>	
<p>The EMP shall provide (a) an implementation schedule for measures that shall be carried out as part of the project, showing phasing and coordination with overall project implementation plans; and (b) the capital and recurrent cost estimates and sources of funds for implementing the EMP. This shall be presented for mitigation, monitoring, and capacity development required for the implementation of the EMP.</p>	
<p><b>Task 8. Stakeholder Consultation</b> — The stakeholder consultation process shall provide opportunities for stakeholders, community involvement and education. It may include interviews with individuals, public communication activities, interest group meetings, production of regular summary information and updates (i.e. newsletters), and other consultation mechanisms to encourage and facilitate active stakeholder consultation. Stakeholders consultation should cover Ministry of Environment and Energy, Greater Male' Investment Limited, WAMCO, EPA, STELCO, Maldives Energy Authority (MEA), Energy Department (MEE), Waste Department (MEE), nearby resorts, Male' City Council, Ministry of Housing and Infrastructure, existing businesses in Thilafushi, existing workers of the facility, NGOs and the general public shall be consulted. Stakeholder consultation processes (community engagement) for all parts of the EIA shall be integrated. Sufficient information about the development and the consultation process shall be provided to the community at an early stage and in accessible and culturally appropriate ways. Information about the development should inform the community about the benefits, disadvantages, trade-offs, potential issues and implications as required, enabling them to formulate their views. Information about the consultation processes conducted and their results shall be provided including:</p> <p>The methodology adopted, a list of stakeholders consulted during the program and how their involvement was facilitated,</p> <p>the processes conducted to date and the future consultation strategies and programs including those during the operational phase of the project,</p> <p>Recommendations on how the project might address concerns raised during public consultation.</p> <p>List of those who are consulted including their names and contacts should be provided in the EIA report,</p>	<p>Compliance in Section VII.</p>

<p><b>Task 8. Climate Change Risk Assessment</b> — Review of literature on climate change specific to the Maldives shall be carried out. Following this, climate change considerations shall be suggested for the project, including sea level rise, tropical cyclonic winds, storm surges, probable maximum precipitation. Climate change adaptation considerations for the design shall be discussed.</p>	<p>Compliance with this task is covered across the different sections of the EIA report, but not explicit because the assessment is yet to be undertaken through a CVRA.</p> <p>Since the project will be awarded under a DBO contract, the risks due to climate change will be integrated in the final detailed design that is to be undertaken during design phase.</p>
<p><u>Presentation</u>- The environmental impact assessment report, to be presented in digital format, shall be concise and focus on significant environmental issues. It shall contain the findings, conclusions and recommended actions supported by summaries of the data collected and citations of or any references used in interpreting those data. The environmental assessment report shall be organized according to, but not necessarily limited by, the outline given in the Environmental Impact Assessment Regulations, 2012 and relevant amendments.</p>	<p>Yet to be complied.</p>
<p>Timeframe for submitting the EIA report — The developer shall submit the completed EIA report within 6 months from the date of this Term of Reference.</p>	

## Comparative Analysis of Maldives Framework and ADB Safeguard Policy Statement

(A) ADB Safeguard Policy Statement	(B) Corresponding Legal Provisions of the draft of the Law on EIA <sup>1</sup>	(C) Extent of Equivalence <sup>2</sup>	(D) Recommended Gap-filling Measures
Policy Principle 1: Use a screening process for each proposed project, as early as possible, to determine the appropriate extent and type of environmental assessment so that appropriate studies are undertaken commensurate with the significance of potential impacts and risks.			
Key element (1) Use a screening process to determine the appropriate extent and type of environmental assessment	The <b>EIA regulations</b> , in particular Part III elaborates the process by which screening is used to identify proposals that have little or no environmental impact that are separated by projects that require an in-depth study. Schedule D of the EIA regulations list of projects that need to undertake an EIA because of likely severity of impacts. Proposals not listed in Schedule D are required to submit a Development Proposal Screening Form (Schedule C 1 of EIA Regulations) that is submitted to the Ministry of Environment where a decision is made either to approve the project or determine if further information is required through the preparation of an IEE needs (Schedule C 3 of EIA Regulations provides the Development Proposal Screening Decision Form). For projects falling under Schedule D an EIA application needs to be submitted along with TORs for the EIA to the Ministry of Environment for approval with or without proposed revisions. An EIA then should be prepared based on the TORs approved by the Ministry of Environment	Full Equivalence	None required
Policy Principle 2: Conduct an environmental assessment for each proposed project to identify potential direct, indirect, cumulative, and induced impacts and risks to physical, biological, socioeconomic (including impacts on livelihood through environmental media, health and safety, vulnerable groups, and gender issues), and physical cultural resources in the context of the project's area of influence. Assess potential trans-boundary and global impacts, including climate change. Use strategic environmental assessment where appropriate.			

<sup>1</sup> There are relevant provisions of the Environment Protection and Preservation Act of 1993, Environmental Protection Regulations of 2007 that deal with environmental assessment and management..

<sup>2</sup> "Full Equivalence" denotes that the Maldives legal requirement(s) are in complete harmony with the corresponding ADB Safeguard Objective, Scope and Trigger, Policy Principle or Key Element thereof. "Partial Equivalence" denotes that the Maldives legal requirement is in partial harmony with the corresponding ADB Safeguard Objective, Scope and Trigger, Policy Principle or Key Element; and "No Equivalence" denotes that no Maldives legal requirement can be found that corresponds to the particular ADB Safeguard Objective, Scope and Trigger, Policy Principle or Key Element.

(A) ADB Safeguard Policy Statement	(B) Corresponding Legal Provisions of the draft of the Law on EIA <sup>1</sup>	(C) Extent of Equivalence <sup>2</sup>	(D) Recommended Gap-filling Measures
Key element (1)  Identify indirect as well as direct impacts	<b>Schedule E of the EIA Regulations</b> requires that the direct and indirect environmental impacts on bio-physical, economic and human environment, including impacts on human well-being be assessed	Full compliance	None required
Key element (2) Identify cumulative impacts	The <b>EIA Regulations</b> , defines “EIA” as a means of identifying, predicting, evaluating and mitigating the biophysical, social, cumulative, economic and other relevant effects of a proposed development and “Cumulative Impacts” as the contained effect on the environment of two or more activities, or parts of projects, including synergistic projects  Similarly, the EIA Regulations require the project proponent to provide information on other similar projects in the area and IEEs and EIAs done for those projects	Full equivalence.	None required
Key element (3) Identify induced impacts	<b>The EIA Regulations</b> requires the assessment of indirect impacts, which are defined as “indirect results...as those caused by an action or actions and are later in time or further removed in distance, but are still reasonably foreseen, and includes growth-regulating effects and other effects to induced changes in the patterns of land-use, population density or growth rate and related effects on air, water and other natural systems, including ecosystems”	Full equivalence	None required
Key element (4) Identify physical impacts	<b>Schedule E of the EIA Regulations</b> requires that the direct and indirect environmental impacts on bio-physical, economic and human environment, including impacts on human well-being be assessed and that includes the description and direct and indirect impacts on the following: <ul style="list-style-type: none"><li>- Soil, relief, landforms, land use and drainage systems</li><li>- Surrounding infrastructure and drainage; and</li><li>- Beach systems, including composition, stability, tide and wave dynamics</li></ul>	Full Equivalence.	None required
Key element (5)	<b>Schedule E of the EIA Regulations</b> requires that the direct and indirect environmental impacts on bio-physical, economic and human environment, including the impacts on the following biological elements:	Full Equivalence.	None required

(A) ADB Safeguard Policy Statement	(B) Corresponding Legal Provisions of the draft of the Law on EIA <sup>1</sup>	(C) Extent of Equivalence <sup>2</sup>	(D) Recommended Gap-filling Measures
Identify biological impacts	<ul style="list-style-type: none"> <li>- Flora, fauna, rare or endangered species, sensitive habitats of ecological importance, including mangroves and wetlands; and</li> <li>- Marine environment, including sandy and rocky bottoms, coral reefs and sea grass beds</li> </ul>		
Key element (6)  Identify socioeconomic impacts (including on livelihood through environmental health and safety, vulnerable groups, and gender issues)	<p>In the <b>EIA Regulations</b>, “EIA” is defined as a means of identifying, predicting, evaluating and mitigating the biophysical, social, cumulative, economic and other relevant effects of a proposed development and “the Human Environment” as the natural and physical environment and the relationships of people.</p> <p><b>Schedule C.1 of the EIA Regulations Part 3</b> requires the EIA to identify and assess the impacts on public well-being, public health, public safety, public transport, employment and economic status.</p>	<p>Partial Equivalence</p> <p>There is no reference in the EIA legislation regarding need to assess impacts on vulnerable groups and gender issues.</p>	<p>For full equivalence, the EIA Regulations should include assessment of the impact on vulnerable groups and gender related impacts.</p>
Key element (7)  Identify impacts on physical cultural resources	<p><b>Part II (2) of the EIA Regulations</b> requires EIAs and IEEs to consider effects of development programs on:.....(d) material assets and cultural heritage.</p> <p><b>Schedule E of the EIA Regulations</b> requires description of natural, economic and human environment, that includes among other things.....socio-economic characteristics....., including unique cultural characteristics.</p>	Full equivalence	None required
Key element (8)  Identify impacts in the context of the project’s area of influence	<p>There is reference to defining the boundaries of the area affected by the development project, but no specific reference to the context of the project’s area of influence, although the <b>EIA regulations</b> refers to induced impacts relating to changes patterns of land-use, population density or growth rate and related effects on air, water and other natural systems, including ecosystems, that might extend beyond the boundaries of the project area</p>	Full equivalence	None required
Key element (9)  Assess potential trans-boundary impacts	<p>There is no explicit reference to “assessment of trans-boundary impacts” in the legal framework.</p>	No Equivalence.	<p>For full compliance, new or revised legislation/regulations should require assessment of trans-boundary impacts</p>
Key element (10)  Assess potential global impacts, including climate change	<p><b>Part II Section 4 of the EIA Regulations</b> requires that project proponents take into account all policies and legislation, including commitments as Party to relevant International Conventions and Protocols</p>	Full Equivalence	None required

(A) ADB Safeguard Policy Statement	(B) Corresponding Legal Provisions of the draft of the Law on EIA <sup>1</sup>	(C) Extent of Equivalence <sup>2</sup>	(D) Recommended Gap-filling Measures
Key element (11) Use strategic environmental assessment	There is no explicit reference to conduct of strategic environmental assessment in the legislation	No equivalence	To achieve full compliance the EIA regulations or similar legislation should require the conduct of SEAs, including assessment of plans, programs and policies
Policy Principle 3: Examine alternatives to the project's location, design, technology, and components and their potential environmental and social impacts and document the rationale for selecting the particular alternative proposed. Also consider the no-project alternative.			
Key element (1) Examine alternatives to the project's location, design, technology.	<p><b>Schedule E of the EIA regulations</b> discusses the need for consideration of alternatives such as:</p> <ul style="list-style-type: none"> <li>(i) To identify and describe at least 3 alternatives, one of which should be the no-development option, define clear criteria to evaluate the alternatives, and determine the preferred alternative;</li> <li>(ii) Discuss whether the project be undertaken elsewhere, perhaps an alternate locations with less likely impacts; and</li> <li>(iii) Include discussion of alternative ways in which the project can may be carried out to cause less harm to the environment.</li> <li>(iv) Discuss the preferred alternative and why it was selected</li> </ul>	Full equivalence	None required
Key element (2) Consider the no-project alternative	<p><b>Schedule E of the EIA regulations</b> requires the need to:</p> <ul style="list-style-type: none"> <li>(i) To identify and describe at least 3 alternatives, one of which should be the no-development option, define clear criteria to evaluate the alternatives, and determine the preferred alternative;</li> </ul>	Full equivalence	None required
Policy Principle 4: Avoid, and where avoidance is not possible, minimize, mitigate, and/or offset adverse impacts and enhance positive impacts by means of environmental planning and management. Prepare an environmental management plan (EMP) that includes the proposed mitigation measures, environmental monitoring and reporting requirements, related institutional or organizational arrangements, capacity development and training measures, implementation schedule, cost estimates, and performance indicators. Key considerations for EMP preparation include mitigation of potential adverse impacts to the level of no significant harm to third parties, and the polluter pays principle.			
Key element (1) Avoid, and where avoidance is not possible, minimize, mitigate, and/or offset adverse impacts	<p><b>The EIA Regulations</b> recognizes the following explicit mitigation actions to emanate from the EIA process:</p> <ul style="list-style-type: none"> <li>(a) Avoiding the impact altogether by not taking a certain action or a part of an action</li> <li>(b) Minimizing negative impacts by limiting the degree and magnitude of the action and its implementation</li> </ul>	Full equivalence	None required

(A) ADB Safeguard Policy Statement	(B) Corresponding Legal Provisions of the draft of the Law on EIA <sup>1</sup>	(C) Extent of Equivalence <sup>2</sup>	(D) Recommended Gap-filling Measures
and enhance positive impacts by means of environmental planning and management	<ul style="list-style-type: none"> <li>(c) Optimizing the positive impacts of development</li> <li>(d) Rectifying the impact by repairing, rehabilitating or restoring the affected environment</li> <li>(e) Reducing or eliminating the impact over time by conservation operations during the life of the action; and</li> <li>(f) Compensating for the impact by replacing or providing substitute resources or environments</li> </ul>		
Key element (2) Prepare an environmental management plan (EMP)	<b>Schedule E of the EIA Regulations “Contents of an IEE of EIA study”</b> outlines the Content of an IEE study or EIA study report that development proponents are expected to prepare and submit to the Ministry of Environment for review and provision of environmental clearance of a development project, that includes a report with proposed measures to mitigate adverse environmental impacts.	Full equivalence	None required
Key Element (3) Prepare an environmental management plan (EMP) that includes the proposed... environmental monitoring and reporting requirements	<p><b>Schedule E of the EIA Regulations “Contents of an IEE of EIA study” under title “Environmental Monitoring”</b> requires the preparation of an environmental monitoring plan that includes provisions for on-site monitoring during (i) site preparation; (ii) construction/implementation and (iii) decommissioning phases, as well as the longer-term maintenance requirements</p> <p><b>Schedule M of the EIA Regulations “Format for Environmental Monitoring Reports”</b> requires the submission of summary reports at 2 monthly intervals and a final report at the end of the decommissioning phase or as specified in the Environmental Decision Statement to be submitted to the Ministry</p>	Full Equivalence	None required
Key Element (4) Prepare an environmental management plan (EMP) that includes... related institutional or organizational arrangements	<p><b>Schedule I of the EIA Regulations “Review of IEE or EIA study”</b></p> <p>Number 7: “Mitigation” requires the mitigation measures or “EMP” Plan to define in specific, practical terms the costs, manpower, equipment, timing and technology needed</p>	Partial Equivalence  While, the EMP is required to provide for manpower requirements for its implementation, it is not explicit in terms of requiring institutional or organization arrangements for its implementation	To attain full equivalence, the EMP should explicitly require the definition of institutional or organization arrangement
Key Element (5) Prepare an environmental management plan (EMP) that includes the	<p><b>Schedule I of the EIA Regulations “Review of IEE or EIA study”</b></p> <p>Number 7: “Mitigation” requires an assessment of institutional capacity to carry out mitigation measures</p>	Partial Equivalence  The requirement for capacity development and training for	To attain full equivalence, the legislation should made explicit reference for including capacity building and training

(A) ADB Safeguard Policy Statement	(B) Corresponding Legal Provisions of the draft of the Law on EIA <sup>1</sup>	(C) Extent of Equivalence <sup>2</sup>	(D) Recommended Gap-filling Measures
proposed... capacity development and training measures		implementation of EMP is implicit, rather than explicit in the legislation	needs in the EMP
Key Element (6) Prepare an environmental management plan (EMP) that includes the proposed ... implementation schedule	<b>Schedule I of the EIA Regulations “Review of IEE or EIA study”</b> Number 7: “Mitigation” requires the mitigation measures or “EMP” Plan to define in specific, practical terms the costs, manpower, equipment, <u>timing</u> and technology needed	Full Equivalence	None required
Key Element (7) Prepare an environmental management plan (EMP) that includes the proposed... cost estimates	<b>Schedule I of the EIA Regulations “Review of IEE or EIA study”</b> Number 7: “Mitigation” requires the mitigation measures or “EMP” Plan to define in specific, practical terms the <u>costs</u> , manpower, equipment, timing and technology needed	Full Equivalence	None required
Key element (8) Prepare an environmental management plan (EMP) that includes the proposed ... performance indicators	<b>Schedule M of the EIA Regulations “Format for Environmental Monitoring Reports”</b> is comprehensive, including requirements for monitoring and reporting on (i) implementation of mitigation measures; (ii) monitoring results, including date, time frequency and duration; (iii) presentation of environmental quality performance and standards; (iv) presentation of monitored parameters, etc.	Full Equivalence	None required
Key Element (9) Key considerations for EMP preparation include mitigation of potential adverse impacts to the level of no significant harm to third parties, and the polluter pays principle.	The legislation is implicit in terms of the requirement to avoid or minimizing the impact on the environment or human health and safety	Partial Equivalence  There is no explicit reference to the polluter play principle	To attain full equivalence, the legislation should explicitly made requirement for ensuring that the developer or polluter pay if there is damage to the environment or third party
Policy Principle 5: Carry out meaningful consultation with affected people and facilitate their informed participation. Ensure women’s participation in consultation. Involve stakeholders, including affected people and concerned nongovernment organizations, early in the project preparation process and ensure that their views and concerns are made known to and understood by decision makers and taken into account. Continue consultations with stakeholders throughout project implementation as necessary to address issues related to environmental assessment. Establish a grievance redress mechanism to receive and facilitate resolution of the affected people’s concerns and grievances regarding the project’s environmental performance.			
Key element (1) Carry out meaningful	<b>Schedule E of the EIA Regulations</b> lists the Public Consultation requirements as follows:	Partial equivalence	For full equivalence, the EIA Regulations should explicitly



(A) ADB Safeguard Policy Statement	(B) Corresponding Legal Provisions of the draft of the Law on EIA <sup>1</sup>	(C) Extent of Equivalence <sup>2</sup>	(D) Recommended Gap-filling Measures
consultation with affected people and facilitate their informed participation	<p>That the IEE and EIA process and report should include:</p> <ul style="list-style-type: none"> <li>(a) A list of persons consulted including persons in statutory bodies, atolls and island offices, community groups and NGOs, local residents, local fishermen, tourism operators and others likely to be affected by the proposed development</li> <li>(b) Information on how, when and where consultations were conducted, e.g. stakeholder meetings in affected area, individual meetings, questionnaires; and</li> <li>(c) Summary of outcome of consultations, including the main concerns identified.</li> </ul>	There is no clear timeline established when consultation should occur, if consultation should take place throughout project implementation and the means for resolution of any affected person's concerns	identifying the different stages at which consultation should take place (e.g. early in EIA process, before finalization of EIA and during project implementation and monitoring) as well as means to address people's concerns and grievances
Key element (2) Ensure women's participation in consultation	There is no explicit reference to women's participation in the consultative process, although reference to consultation in the EIA regulations.	No equivalence	For full equivalence the EIA Regulations should explicitly require consultation and participation of women in the EIA process and during project implementation
Key element (3) Involve stakeholders, including affected people and concerned nongovernment organizations, early in the project preparation process.	<p>While there is explicit reference in <b>Schedule E of the EIA Regulations</b> of the requirements for involving stakeholders and affected people as outlined below, it does not specify the stages (including early in project preparation process) that consultation is mandatory:</p> <p>That the IEE and EIA process and report should include:</p> <ul style="list-style-type: none"> <li>(a) A list of persons consulted including persons in statutory bodies, atolls and island offices, community groups and NGOs, local residents, local fishermen, tourism operators and others likely to be affected by the proposed development</li> <li>(b) Information on how, when and where consultations were conducted, e.g. stakeholder meetings in affected area, individual meetings, questionnaires; and</li> <li>(c) Summary of outcome of consultations, including the main concerns identified.</li> </ul>	<p>Partial equivalence</p> <p>There is no reference in the legislation to the stages and timing of consultations</p>	To attain full equivalence, the EIA Regulations should explicitly identifying the different stages at which consultation should take place, including early in the project preparation process
Key element (4) Establish a grievance redress mechanism	There is no explicit reference to establishment of a grievance redress mechanism at the project level.	No equivalence	For full equivalence the EIA Regulations should specify mechanisms for addressing people's grievances both during the EIA process and during project implementation
Policy Principle 6: Disclose a draft environmental assessment (including the EMP) in a timely manner, before project appraisal, in an accessible place and in a form and language(s) understandable to			

(A) ADB Safeguard Policy Statement	(B) Corresponding Legal Provisions of the draft of the Law on EIA <sup>1</sup>	(C) Extent of Equivalence <sup>2</sup>	(D) Recommended Gap-filling Measures
affected people and other stakeholders. Disclose the final environmental assessment, and its updates if any, to affected people and other stakeholders.			
Key element (1) Disclose a draft environmental assessment (including the EMP) in a timely manner, before project appraisal, in an accessible place.	The EIA Regulations require public consultations, and the invent that the project is complex and sufficiently controversial, the Ministry of Environment can request additional public consultation. This would take place before the EA report is finalized.	Partial equivalence  There is no guidance on the disclosure of draft EA (and EMP), including timing, location and language	To achieve full equivalence, the EIA Regulations should clearly specify the timing, location, language and other specifics regarding the disclosure of the draft EA (and EMP)
Key element (2) Disclose the final environmental assessment, and its updates if any, to affected people and other stakeholders	There is no guidance in the legislation regarding the disclose of the final EA report and EMP, although the decision of approval or environmental clearance has to be disclosed	No equivalence	For full equivalence, the EIA Regulation should explicitly specify the need for disclosure of the final EA and EMP reports in an accessible location and in a language that is understandable to the affected people and other stakeholders
Policy Principle 7: Implement the EMP and monitor its effectiveness. Document monitoring results, including the development and implementation of corrective actions, and disclose monitoring reports.			
Key element (1) Implement the EMP and monitor its effectiveness.	<b>The EIA Regulations, Schedule J “Environment Decision Statement”</b> issued to the developer by the Ministry of Environment, Item 2 (i) (ix) requires that all mitigation measures proposed in the EIA report for the construction phase and operational phase as outlined in page/s (as per the EIA Report) shall be fully implemented.	Full equivalence	None required
Key element (2) Document monitoring results, including the development and implementation of corrective actions, and disclose monitoring reports.	<b>The EIA Regulations, Part IV Item 13 “Environmental Monitoring and Mitigation</b> has the following instructions:  (i) The proponent shall fund and conduct environmental monitoring and implementing mitigation measures for the development proposal if specified and required by virtue of the Environmental Decision Statement  (ii) The proponent shall regularly submit summary environmental monitoring reports.....  (iii) The proponent shall maintain records of all monitoring data and on request make these available to the Ministry of Environment  (iv) The proponent shall submit a final environmental monitoring and mitigation report to the	Partial equivalence  There is no requirement for public disclosure of the monitoring results, disclosure is limited to submission to government agencies	For full equivalence, the EIA Regulations should specify requirement for public disclosure of monitoring results

(A) ADB Safeguard Policy Statement	(B) Corresponding Legal Provisions of the draft of the Law on EIA <sup>1</sup>	(C) Extent of Equivalence <sup>2</sup>	(D) Recommended Gap-filling Measures
	<p>Ministry of Environment when the project is completed or at such time as may be specified in the Environment Decision Statement</p> <p>(v) The Ministry of Environment may request to put in place necessary additional measures based on the finding of the monitoring reports</p>		
<p>Policy Principle 8: Do not implement project activities in areas of critical habitats, unless (i) there are no measurable adverse impacts on the critical habitat that could impair its ability to function, (ii) there is no reduction in the population of any recognized endangered or critically endangered species, and (iii) any lesser impacts are mitigated. If a project is located within a legally protected area, implement additional programs to promote and enhance the conservation aims of the protected area. In an area of natural habitats, there must be no significant conversion or degradation, unless (i) alternatives are not available, (ii) the overall benefits from the project substantially outweigh the environmental costs, and (iii) any conversion or degradation is appropriately mitigated. Use a precautionary approach to the use, development, and management of renewable natural resources.</p>			
<p>Key Element (1)</p> <p>Do not implement project activities in areas of critical habitats, unless (i) there are no measurable adverse impacts on the critical habitat that could impair its ability to function, (ii) there is no reduction in the population of any recognized endangered or critically endangered species, and (iii) any lesser impacts are mitigated.</p>	<p><b>The EIA Regulations</b> defines natural environment as:</p> <ul style="list-style-type: none"> <li>(i) Natural features consisting of physical and biological formations or groups of such formations</li> <li>(ii) Geological and physiological, geomorphical, lithostratigraphical, palaeontological and hydrological functions and precisely delineated areas which constitute the habitat of threatened species of fauna and flora; and</li> <li>(iii) Natural sites of precisely delineated areas of value from the point of view of science, scenic value, conservation or natural beauty.</li> </ul> <p><b>The EIA Regulations Schedule B</b> further requires development to ensure that economic development is sustainable and that any development project assess the “presence or absence of critical ecosystems” that would “Environmental Sensitive Areas” (ESA) that have been identified by the Ministry of Environment. If such an ESA has been identified in the development area, that that site should be either removed for consideration for future development or that development could take place, taking into consideration the conservation of the sensitive area, there by mitigating the negative impacts.</p>	Full Equivalence	None required
<p>Key Element (2)</p> <p>If a project is located within a legally protected area, implement additional programs to promote and enhance conservation aims of the protected area</p>	<p><b>The EIA Regulations Schedule B</b> further requires development to ensure that economic development is sustainable and that any development project assess the “presence or absence of critical ecosystems” that would “Environmental Sensitive Areas” (ESA) that have been identified by the Ministry of Environment. If such an ESA has been identified in the development area, that that site should be either removed for consideration for future development or that development could take place, taking into consideration the conservation of the sensitive area, there by mitigating the negative impacts.</p> <p>However <b>Schedule B of the EIA Regulations</b> clarifies that if a site/island or its surrounding reef is part of the island/reef ecosystem included in the ESA sites listed for special protection, such sites should not be</p>	Partial Equivalence	To attain full equivalence, the legislation should be explicit if development can take place in protected areas or ESAs, and if so under what conditions and what added measures are necessary for enhancing conservation of the area

(A) ADB Safeguard Policy Statement	(B) Corresponding Legal Provisions of the draft of the Law on EIA <sup>1</sup>	(C) Extent of Equivalence <sup>2</sup>	(D) Recommended Gap-filling Measures
	considered for any development. Also, any site/island selected for development must have at least a 20 m space (measured from the seaward edge inland) for maintenance of an undisturbed band of vegetation that could serve as a “no-development” buffer zone, or else it should be removed from any development activity		
Key Element (3) In an area of natural habitats, there must be no conversion or degradation, unless (i) alternatives are not available; (ii) the overall benefits from the project substantially outweigh the environmental costs, and (iii) any conversion or degradation is appropriately mitigated	While, the legislation recognizes the need to ensure that development is excluded from specially designed environmentally sensitive sites, <b>the EIA Regulations</b> calls for evaluation of alternatives ways to development that cause less harm of the environment (that is defined as fauna, flora and natural habitats....)	Partial equivalence  There is no explicit requirement for evaluating cost and benefits of damaging the environment (including natural habitats) in decision-making on conversion or degradation of natural habitats	To attain full equivalence, the legislation should specify the options for conversion and/or degradation of natural habitats including assessment of costs and benefits of conversion and mitigation options
Key Element (4) Use a precautionary approach to the use, development, and management of renewable natural resources	<b>Schedule B of the EIA Regulations</b> states that development that is in harmony with the natural environment is the preferred approach for the Maldives and environment is defined as the fauna, flora, natural habitat and the human environment. However, there is no specific reference to use of a precautionary approach to management of renewable natural resources	No Equivalence	To attain full equivalence, the legislation should require the explicit use of a precautionary approach to use and management of renewable natural resources
Policy Principle 9: Apply pollution prevention and control technologies and practices consistent with international good practices as reflected in internationally recognized standards such as the World Bank Group’s Environmental, Health and Safety Guidelines. Adopt cleaner production processes and good energy efficiency practices. Avoid pollution, or, when avoidance is not possible, minimize or control the intensity or load of pollutant emissions and discharges, including direct and indirect greenhouse gases emissions, waste generation, and release of hazardous materials from their production, transportation, handling, and storage. Avoid the use of hazardous materials subject to international bans or phaseouts. Purchase, use, and manage pesticides based on integrated pest management approaches and reduce reliance on synthetic chemical pesticides.			
Key element (1) Apply pollution prevention and control technologies and practices consistent with international good practices.	The main piece of legislation that provides regulations for the protection and prevention of pollution is the <b>Environment Protection and Preservation Act of 1993</b>  Under section 1 of Act, requires the Government and citizens to give special attention to the protection of its environment including both sea and the atmosphere. The relevant Government authorities shall also provide guidelines for the protection and preservation and everyone is required to respect such guidelines.  Under section 7(a), any type of wastes, oils, poisonous gases or any substance that may have harmful	Partial equivalence  While the EPPA does not make reference to international standards of pollution management	For full equivalence, guidelines are required as stipulated by the EPP Act to manage and deal with the pollution of air, water, land based on internationally recognized standards

(A) ADB Safeguard Policy Statement	(B) Corresponding Legal Provisions of the draft of the Law on EIA <sup>1</sup>	(C) Extent of Equivalence <sup>2</sup>	(D) Recommended Gap-filling Measures
	effects on the environment shall not be disposed of within the territory of the Maldives. In cases where the disposal of such substances becomes absolutely necessary, they shall be disposed of only within those areas designated for such purposes by the Government. If such waste is to be incinerated, appropriate precautions should be taken to avoid any harm to the health of the population. Similarly, the Act also states that wastes that are harmful to human health and the environment shall not be disposed of anywhere within the territory of the country and permission should be obtained from the relevant authority at least 3 months in advance of any trans-boundary movement of such wastes through the territory of the Maldives.		
Key Element (2) Adopt cleaner production processes and good energy efficiency practices	<b>Schedule E of the EIA Regulations “Project Description”</b> requires the project proponent to identify measures to be adopted to promote sustainable development, including cleaner production, renewable energy systems) during the implementation and operational phases of the project	Full Equivalence	None required
Key Element (3) Avoid pollution, or, when avoidance is not possible, minimize or control the intensity or load of pollutant emissions and discharges, including direct and indirect greenhouse gases emissions, waste generation, and release of hazardous materials from their production, transportation, handling, and storage.	<p><b>Environment Protection and Preservation Act</b> in Article 7 and 8 address the issues related to waste disposal and hazardous toxins.</p> <p><b>Article 7 “Waste disposal, Oil and Poisonous Substances”</b> states that</p> <ul style="list-style-type: none"> <li>(a) Any types of waste oil, poisonous gases or any substance that may be harmful on the environment shall not be disposed within the territory of the country</li> <li>(b) In case, where the disposal of substances stated in (a) becomes absolutely necessary, they shall be disposed within the areas designated by the government. If such wastes are incinerated, appropriate precautions should be taken to avoid harm to the health of the population</li> </ul> <p><b>Article 8 Hazardous/Toxic or Nuclear Wastes</b> states that such wastes that is harmful to human health and the environment shall not be disposed in the territory of the country, Permission is required for any transboundary movement of such wastes through the territory of the Maldives</p>	<p>Partial Equivalence</p> <p>There is no recognition of load minimization and control, including measures for generation, release, handling and storage</p>	To attain full equivalence, the legislation should require avoidance and control of emission and discharge loads and handling, production and storage of such materials
Key Element (4) Avoid the use of hazardous materials subject to international bans or phase-outs	The legislation (Environmental Protection and Preservation Act) refers to disposal of hazardous wastes and transboundary movement of such wastes, but is silent on its use and phase-outs	Partial Equivalence	To attain full equivalence, the legislation should deal explicitly with the use of hazardous materials on the basis of international norms and phase out schedules
Key Element (5) Purchase, use, and	There is no specific legislation that governs the purchase, use and management of pesticides in the	No Equivalence	To attain full equivalence, the legislation should provide

(A) ADB Safeguard Policy Statement	(B) Corresponding Legal Provisions of the draft of the Law on EIA <sup>1</sup>	(C) Extent of Equivalence <sup>2</sup>	(D) Recommended Gap-filling Measures
manage pesticides based on integrated pest management approaches and reduce reliance on synthetic chemical pesticides.	Maldives.  The Environment Protection and Preservation Act deals more broadly with the impacts of development related activities on the environment (fauna, flora, natural resources, etc.) and on the health and well being of the people. The direct and indirect impacts on air, water, and other natural systems (that likely refers to soil, renewable and non-renewable natural resources.		guidance on the purchase, use and management (production, transport, storage, handing, disposal) of chemicals use in agriculture
Policy Principle 10: Provide workers with safe and healthy working conditions and prevent accidents, injuries, and disease. Establish preventive and emergency preparedness and response measures to avoid, and where avoidance is not possible, to minimize, adverse impacts and risks to the health and safety of local communities.			
Key Element (1) Provide workers with safe and healthy working conditions and prevent accidents, injuries, and disease.	<p><b>Articles 73 -76 of The Employment Act of 2008</b>, provides coverage of measures for the safety and protection of employees at the work place..... Such measures shall include:-</p> <ul style="list-style-type: none"> <li>i. implementation of a safe work place and procedures, procurement of secure tools and machinery for carrying out work, and ensuring the continued safety of the same;</li> <li>ii. provide safe materials to work with;</li> <li>iii. provide protective equipment and safety equipment in the event that the nature of work is such that it is not possible to eliminate or control health hazards arising out of the work;</li> <li>iv. provide education and training to employees on the use of protective gear and safety equipment, and disseminate to employees information on all issues of related concern;</li> <li>v. conduct regular health checks for employees engaged in work involving chemical or biological materials that may cause a hazard to physical health or employees involved in any work that may cause physical ill health;</li> <li>vi. provide or arrange for appropriate medical care for employees injured while carrying out employment; and</li> <li>vii. arrange the facilitation of first aid to employees in emergencies or accidents.</li> </ul> <p>74. The following are duties imperative upon every employee:-</p> <ul style="list-style-type: none"> <li>i. maintenance of safe work practices at work to avoid danger to the safety and well being of the employee and co-workers which may be caused by inattentiveness to safety and security measures;</li> <li>ii. assist the employer and co-workers in maintenance of measures designed to ensure health and safety in the work place;</li> <li>iii. use safety equipment and protective gear as instructed in accordance with the training and education provided for use of such equipment and gear;</li> <li>iv. report to the employer any damage, loss of or destruction of protective gear or safety equipment;</li> <li>v. inform the employer or his designated supervisor immediately of the occurrence of any incident which the employee believes may cause danger and which the employee is unable to resolve;</li> <li>vi. inform the employer or his designated supervisor of any accidents or damage sustained occurring at</li> </ul>	Full equivalence	None required

(A) ADB Safeguard Policy Statement	(B) Corresponding Legal Provisions of the draft of the Law on EIA <sup>1</sup>	(C) Extent of Equivalence <sup>2</sup>	(D) Recommended Gap-filling Measures
	work or related to work.		
<p>Key Element (2)</p> <p>Establish preventive and emergency preparedness and response measures to avoid, and where avoidance is not possible, to minimize, adverse impacts and risks to the health and safety of local communities</p>	<p><b>The Disaster Management Act of 2006</b> recognizes that it is the state responsibility to protect its people, their property and the natural and built environment they live in from natural and man-made disasters as well as requiring the government to act to manage risks, ensure preparedness, relief and recovery through capacity building, and establishing partnerships with organized local communities and international organizations, as well as preparing a national disaster management plan and national emergency operations plan.</p> <p>The intent is to promote an integrated and coordinated system of disaster management with emphasis on prevention and mitigation, communication, public awareness, knowledge, community participation, etc.</p>	Full Equivalence	None required
<p>Policy Principle 11: Conserve physical cultural resources and avoid destroying or damaging them by using field-based surveys that employ qualified and experienced experts during environmental assessment. Provide for the use of “chance find” procedures that include a pre-approved management and conservation approach for materials that may be discovered during project implementation.</p>			
<p>Key Element (1)</p> <p>Conserve physical cultural resources and avoid destroying or damaging them by using field-based surveys that employ qualified and experienced experts during environmental assessment.</p>	The <b>EIA regulations</b> requires the need to conserve and protect cultural resources	<p>Partial equivalence</p> <p>The legislation lacks mention of the need to use field-based surveys and qualified experts during the EIA process</p>	To attain full equivalence, the legislation should require the use of field based surveys and qualified experts to assess impacts on cultural resources during EIA preparation
<p>Key Element (2)</p> <p>Provide for the use of “chance find” procedures that include a pre-approved management and conservation approach for materials that may be discovered during project implementation</p>	None	There is no guidance on how to deal with “chance finds”	For full equivalence, the EIA regulations or other legislation should provide for the use of “chance find” procedures

## **ENVIRONMENTAL AUDIT OF THE THILAFUSHI RECLAMATION PROJECT**

### **I. INTRODUCTION**

1. ADB Safeguard Policy Statement (SPS) requires that for projects involving facilities and/or business activities that already exist or are under construction, the borrower/client will undertake an environment compliance audit, including on-site assessment, to identify past or present concerns related to impacts on the environment. The objective of the compliance audit is to determine whether actions were in accordance with ADB's safeguard principles and requirements for borrowers/clients and to identify and plan appropriate measures to address outstanding compliance issues.

2. The proposed Waste-to-Energy (WTE) Facility Project at the island of Thilafushi in Maldives will be financed by ADB together with Asian Infrastructure Investment Bank (AIIB). This WTE Facility Project is part of Phase 2 of the Government of Maldives initiative to set up an integrated Regional Waste Management Facility (RWMF) for Zone 3. As part of the environmental impact assessment (EIA) of the WTE Facility Project, all past and present projects associated with the RWMF have been assessed if any of these is/are considered existing or associated facility/ies per definition of ADB SPS. Evaluation showed that the RWMF project component named as "Reclamation of 15 hectares of land at Thilafushi for development of the Regional Waste Management Facility (RWMF) for Zone 3" (Reclamation Project) has been identified as an existing facility relative to the WTE Facility Project. Therefore, an environmental audit is required.

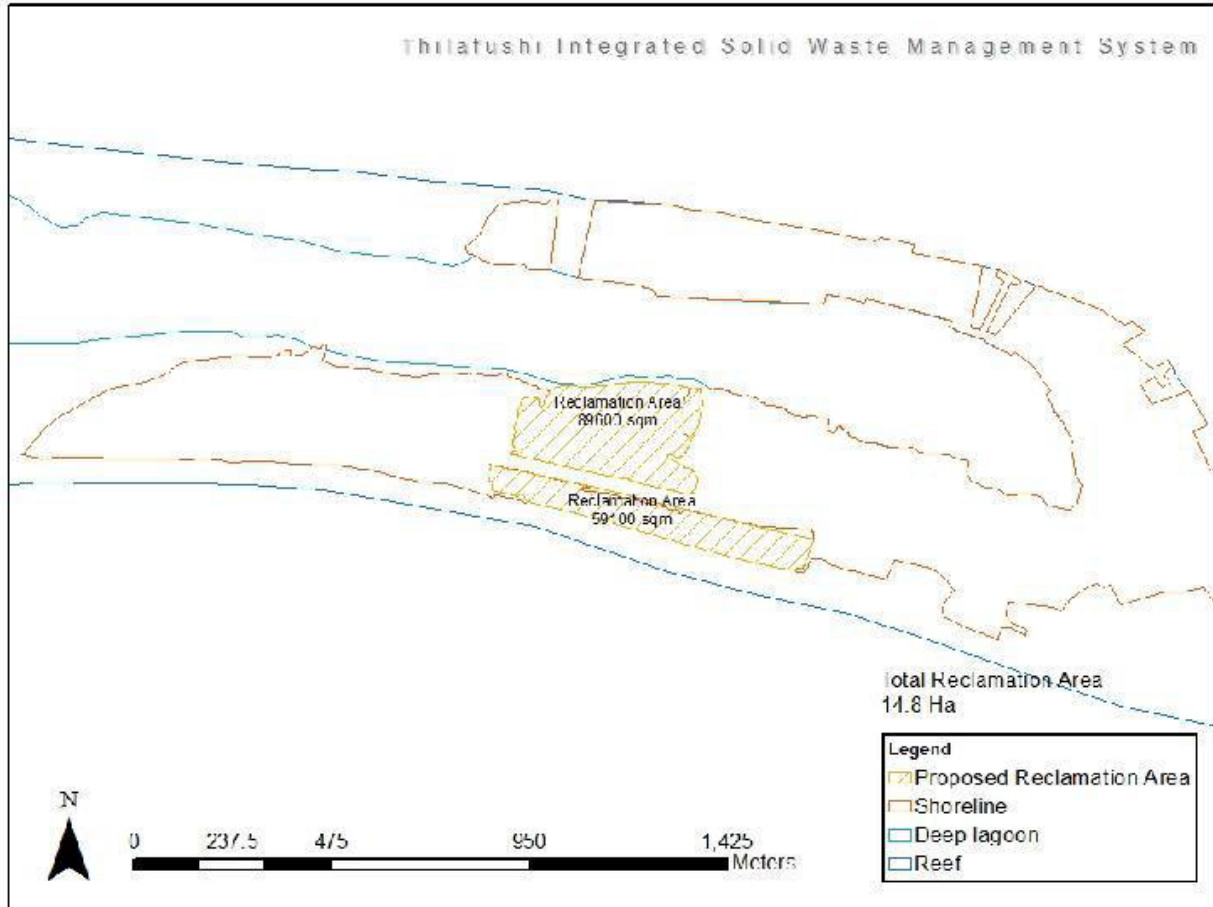
3. As such, an environmental audit has been carried out for the Reclamation Project. Since the Reclamation Project has been completed, the methodology adopted for this audit is documentary review in nature. The environmental safeguard documents of the project were reviewed to identify if it has complied with the relevant national laws, rules and regulations, and to determine if there were issues identified during the implementation of the project that remained outstanding or relevant to the present. The audit was also supplemented by visit to the completed project site (the reclaimed land) and interviews with the people who have been involved in the project implementation.

### **II. DESCRIPTION OF THE LAND RECLAMATION PROJECT**

4. The Reclamation Project involved a dredging and a reclamation component to create the additional land in Thilafushi Island. The reclaimed land is planned as additional site for the various components of the RWMF, including the WTE Facility Project, which this environmental audit has been carried out for.

5. The material for the reclamation was obtained from dredging in the deep seas around Thilafushi Island. The project was designed to reclaim a total area of 15 hectares with an estimated volume of 525,000 cubic meters of dredged materials. The project was also designed to elevate the reclaimed land to a height of +2.0m from mean sea level. The design of the Reclamation Project also included a coastal protection component to protect the created land from erosion. The coastal protection was built by building a revetment using geo-textile containers. Geo-textiles, bags and tubes were filled with sand and placed on the boundary of the reclaimed land as a revetment. The revetment was constructed to a height of +2.5 m from mean sea level. Figure below shows the area that was reclaimed.

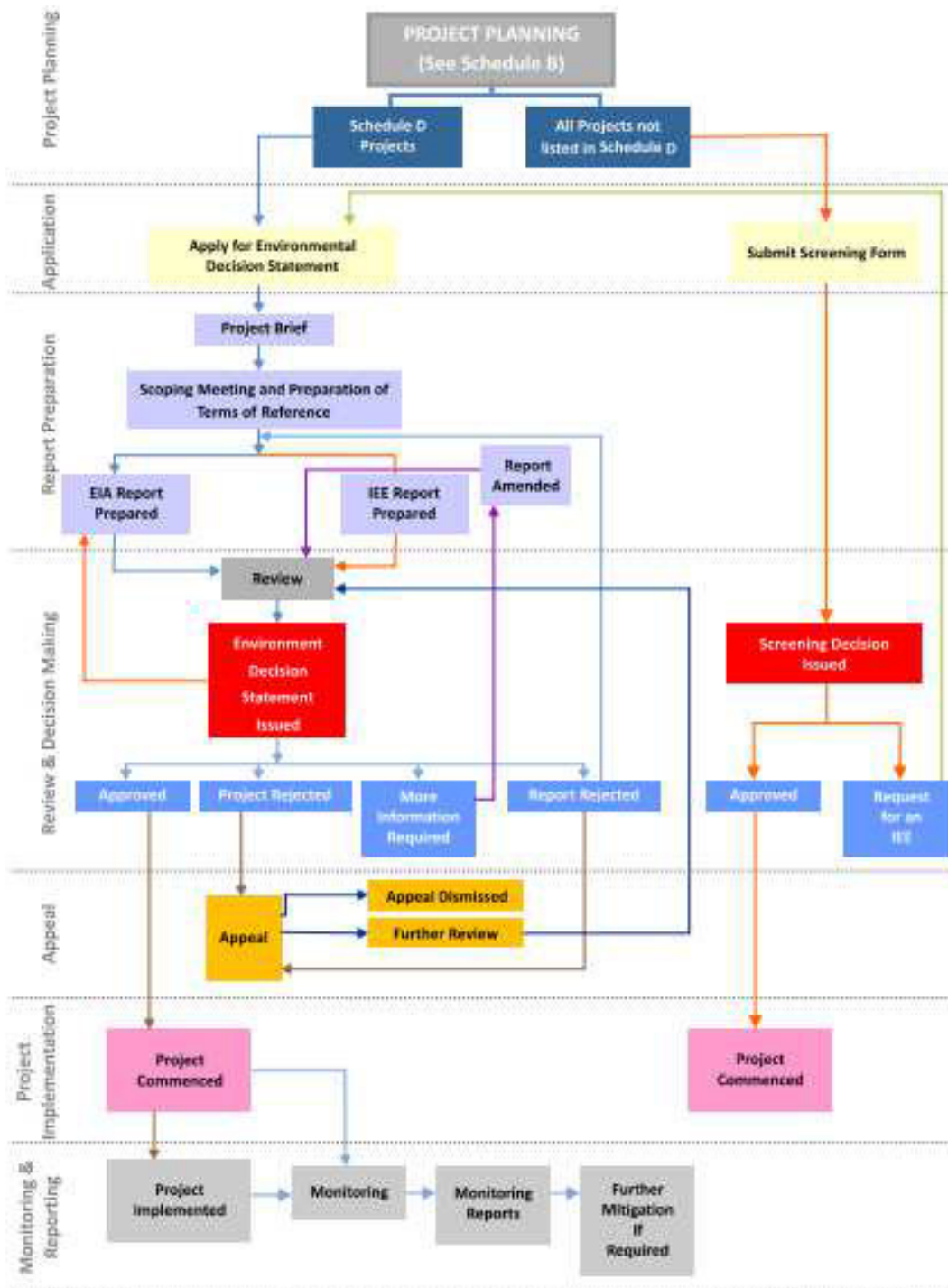




### III. ENVIRONMENTAL COMPLIANCE OF THE PROJECT

6. **Environmental Impact Assessment.** In 2017, an environmental impact assessment (EIA) was undertaken for the project. The EIA process was based on the requirements of EIA Regulation (2012/R-27), the Government of Maldives governing EIA regulation for all projects in the country. This regulation provides the detailed guidelines outlining the EIA process, including the roles and responsibilities of proponent (in this case the Ministry of Environment) and consultant undertaking the EIA. In summary, the project took all the necessary steps in order to finish the EIA and secure approval from the Maldives Environmental Protection Agency (EPA). The following illustration depicts the steps followed:

**FLOW CHART OUTLINING THE PROCESS FOR THE ISSUANCE OF AN ENVIRONMENTAL DECISION STATEMENT**



7. As a result, an EIA report was prepared and submitted to the Maldives EPA. A copy of the EIA report is available to public through the Maldives EPA website. The EIA report is also available from the Ministry of Environment. The front cover of this EIA report is attached as Annex 1 to this audit document.

8. On 17 December 2017, the Maldives EPA issued an approval of the EIA through Environmental Decision Statement No. 203-EIARES/438/2017/180. A copy of this approval document is attached as Annex 2 of this audit document.

9. On 21 February 2018, the contract for the project was awarded to Maldives Transport and Contracting Company Plc. After the award, significant development happened when the proposed methodology under the project was changed due to economic and technical issues. In particular, the initial plan to use Cutter Suction Dredger (CSD) was changed to use of Trailing Suction Hopper Dredger (TSHD). Accordingly, among many other reasons, use of TSHD was deemed more economical compared to use of CSD due to reduced reclamation time. Consequently, the reduction of reclamation time was also deemed as tantamount to having lesser environmental impacts arising from the activities. In view of this, an addendum to the EIA was prepared and submitted to Maldives EPA for approval.

10. On 07 May 2018, the Maldives EPA issued an approval of the First Addendum to the EIA through Environmental Decision Statement No. 203-EIARES/438/2018/87. Accordingly, the mitigation measures proposed in the initial EIA were sufficient for the project. The front cover of the Addendum to the EIA is attached as Annex 3 of this audit document. Also, a copy of the approval document of the First Addendum to the EIA is attached as Annex 4 of this audit document.

11. **Compliance with the conditions of the EIA.** The Environmental Decision Statement provides the conditions with which the proponent should comply with during the implementation of the Reclamation Project. Below is a summary of these conditions and the corresponding compliance by the proponent:

Conditions	Status of Compliance
1. In the event the project activity has not commenced within one (1) year from the date of issue, or if the duration of this Environmental Decision Statement has not been extended, this Environmental Decision Statement shall be considered null and void. In order to extend the duration of this Environmental Decision Statement, the Proponent shall write to the Minister for an extension according to Clause 14 of the 2 <sup>nd</sup> Amendment to the Environmental Impact Assessment Regulations 2012.	Complied. The project has been completed prior to the expiry of the Environmental Decision Statement.
2. In the event the project activities has been delayed for more than one (1) year due to unforeseen circumstances, the Ministry shall have the discretion to extend the duration of the Environmental Decision Statement, or to terminate it. In such circumstances the proponent shall write to the Minister for an extension clearly stating out the reasons for the delay.	Complied. The project has been completed prior to the expiry of the Environmental Decision Statement.
3. The Minister, or his designate, may issue a cessation order requiring persons working on	Complied.

<p>a Development Proposal to cease working until the order is withdrawn, if:  (a) This Environmental Decision Statement has been withdrawn or;  (b) There has been a breach of the conditions of this Environmental Decision Statement.</p>	
<p>4. It is the Developer's responsibility to undertake all project activities in accordance with the relevant laws and regulations of the Maldives.</p>	<p>Complied. The Developer has not been issued any notices or violation (or similar forms) and the project was completed without any breach of relevant laws and regulations.</p>
<p>5. The Developer shall submit environmental monitoring report as outlined in Paragraph viii of this Environmental Decision Statement. Failure to submit the requisite monitoring report may result in the suspension or revocation of the permit under this Decision Statement.</p>	<p>Complied. One Environmental Monitoring Report have been submitted and reviewed as part of this audit. The monitoring report confirmed that overall the environmental performance of the project is acceptable and further monitoring was recommended.</p>
<p>6. The Developer is aware that under the National Environment Protection Act (Law No. 4/93) and the Environmental Impact Assessment Regulations the Ministry reserves the right to terminate any activity without compensation if found that such an activity has caused significant, irreversible impacts on the environment.</p>	<p>Complied. No termination of activities happened.</p>
<p>7. All mitigation measures proposed in the EIA report for all the phases of the project shall be fully implemented.</p>	<p>Complied. No termination of activities happened. It is viewed that all mitigation measures have been implemented.</p>
<p>8. The environmental monitoring program outlined in the Environmental Impact Assessment Report shall be undertaken and implemented and summary environmental monitoring reports shall be submitted to the Ministry.</p>	<p>Complied. Environmental Monitoring Reports and Physical Progress Reports have been prepared and submitted to the Ministry.</p>
<p>9. The date of expiry stated in this Environmental Decision Statement is the duration given to commence the project activities approved under this Environmental Decision Statement.</p>	<p>Complied. The project was accomplished within the duration of the Environmental Decision Statement.</p>
<p>10. Once the project activities have started, the Proponent must inform the Environmental Protection Agency, the date of commencement of project activities.</p>	<p>Complied. Accordingly, this activity was monitored closely by the Maldives EPA.</p>

#### IV. CONCLUSION

12. The Reclamation Project has long been accomplished prior to this environmental audit. No actual dredging activities was observed as part of this audit. However, based on all documents and records reviewed, statutory requirements were complied with and that the necessary

environmental impact assessment was undertaken and approved by the government. There is an indication that the environmental performance of the reclamation project was satisfactory, and that the development activities did not cause any significant adverse impacts to the environment.

Annex 1

## **ENVIRONMENTAL IMPACT ASSESSMENT**

Reclamation of 15 hectares of land at Thilafushi for development of  
the Regional Waste Management Facility for Zone 3

**DRAFT**

June 2017

Proposed by  
Ministry of Environment and Energy

Prepared by  
Ahmed Jameel (EIA P07/2017)  
Ibrahim Faiz (EIA P05/2017)  
Akeed Ahmed (EIA T/2017)

For Water Solutions Pvt. Ltd



Annex 2













x. Once the project activities have started, the Proponent must inform the Environmental Protection Agency, the date of commencement of project activities.

Date of Issue: 17<sup>th</sup> December 2017

تاریخ صدور: 17 دسمبر 2017

Date of expiry: 17<sup>th</sup> December 2018

تاریخ ساقط ہونے کا دن: 17 دسمبر 2018

Name: Yazeed Ahmed

نام: یازید احمد

Designation: Director, Environment Assessment

مقام: ڈائریکٹر، ماحولیات کی جانچ

Signature:

مستور:

**FIRST EIA ADDENDUM TO**  
**Reclamation of 15 hectares of land at Thilafushi for development of**  
**the regional waste management facility for zone 3, Kaafu Atoll,**  
**Maldives**

**PROPONENT**  
**MINISTRY OF**  
**ENVIRONMENT**  
**AND ENERGY**

**Prepared By:**  
Firdous Hussain: EIA  
P21/2016  
Maldives Transport and  
Contracting Company Plc

April 2018

## Annex 4



**مذكرة قرار الموافقة على تقييم الأثر البيئي  
APPROVAL OF ENVIRONMENTAL IMPACT ASSESSMENT**

رقم القرار: 203-EIARES/438/2017/180

مذكرة قرار الموافقة على تقييم الأثر البيئي رقم 180/2017/438-203-ع.إ.أ.ر.ع.م.م. رقم 31 الصادر في 30 نوفمبر 2017م بشأن الموافقة على تقييم الأثر البيئي لمشروع إنشاء وتطوير مرافق إدارة النفايات الإقليمية في ثيلافوشي (المنطقة الثالثة)، كاфу Atoll، والتي تم تقديمها للتقييم في 20 نوفمبر 2017م من قبل وزارة البيئة والطاقة. المستشارين البيئيين لهذا المشروع هما: **السيد أحمد جميل (EIA P07/2017)** و **السيد إبراهيم فايز (EIA P05/2017)**.

*This Environmental Decision Statement is issued for the purpose of communicating the decision regarding the Environmental Impact Assessment for Reclamation of 15 hectares of Land for Development of Regional Waste Management Facility at Thilafushi ( Zone III), Kaafu Atoll, which was submitted for evaluation on 20<sup>th</sup> November 2017 by Ministry of Environment and Energy. The EIA consultants of this project are Mr. Ahmed Jameel (EIAP07/2017) and Mr. Ibrahim Faiz ( EIA P05/2017).*

1. This Environmental Decision Statement has been issued on behalf of the Environmental Protection Agency (hereinafter referred to as the Ministry) pursuant to the Environmental Impact Assessment Regulations 2012 (2012/R-27) to advise that the Ministry has decided that the proposed Development Proposal can proceed according to the Environmental Impact Assessment Report.

1. مذكرة قرار الموافقة على تقييم الأثر البيئي رقم 180/2017/438-203-ع.إ.أ.ر.ع.م.م. رقم 31 الصادر في 30 نوفمبر 2017م بشأن الموافقة على تقييم الأثر البيئي لمشروع إنشاء وتطوير مرافق إدارة النفايات الإقليمية في ثيلافوشي (المنطقة الثالثة)، كاфу Atoll، والتي تم تقديمها للتقييم في 20 نوفمبر 2017م من قبل وزارة البيئة والطاقة. المستشارين البيئيين لهذا المشروع هما: **السيد أحمد جميل (EIA P07/2017)** و **السيد إبراهيم فايز (EIA P05/2017)**.











the Environmental Impact Assessment Regulations the Ministry reserves the right to terminate any activity without compensation if found that such an activity has caused significant, irreversible impacts on the environment.

2012 မှတ်တမ်း အညွှန်းနှင့် မညီညွတ်စွာ  
 အညွှန်း အညွှန်း အညွှန်း အညွှန်း အညွှန်း  
 အညွှန်း အညွှန်း အညွှန်း အညွှန်း အညွှန်း  
 အညွှန်း အညွှန်း အညွှန်း အညွှန်း အညွှန်း  
 အညွှန်း အညွှန်း အညွှန်း အညွှန်း အညွှန်း  
 အညွှန်း အညွှန်း အညွှန်း အညွှန်း အညွှန်း

vii. All mitigation measures proposed in the EIA report for all the phases of the project shall be fully implemented.

vii မြေအောက်ရေ အညွှန်း အညွှန်း အညွှန်း  
 အညွှန်း အညွှန်း အညွှန်း အညွှန်း အညွှန်း  
 အညွှန်း အညွှန်း အညွှန်း အညွှန်း အညွှန်း  
 အညွှန်း အညွှန်း အညွှန်း အညွှန်း အညွှန်း  
 အညွှန်း အညွှန်း အညွှန်း အညွှန်း အညွှန်း

viii. The environmental monitoring program outlined in the Environmental Impact Assessment Report shall be undertaken and implemented and summary environmental monitoring reports shall be submitted to the Ministry.

viii မြေအောက်ရေ အညွှန်း အညွှန်း အညွှန်း  
 အညွှန်း အညွှန်း အညွှန်း အညွှန်း အညွှန်း  
 အညွှန်း အညွှန်း အညွှန်း အညွှန်း အညွှန်း  
 အညွှန်း အညွှန်း အညွှန်း အညွှန်း အညွှန်း  
 အညွှန်း အညွှန်း အညွှန်း အညွှန်း အညွှန်း

ix. The date of expiry stated in this Environmental Decision Statement is the duration given to commence the project activities approved under this Environmental Decision Statement.

ix မြေအောက်ရေ အညွှန်း အညွှန်း အညွှန်း  
 အညွှန်း အညွှန်း အညွှန်း အညွှန်း အညွှန်း  
 အညွှန်း အညွှန်း အညွှန်း အညွှန်း အညွှန်း  
 အညွှန်း အညွှန်း အညွှန်း အညွှန်း အညွှန်း

*[Handwritten signature]*



x. Once the project activities have started, the Proponent must inform the Environmental Protection Agency, the date of commencement of project activities.

x. دسٲٲرٲٲر دسٲرٲٲر دسٲرٲٲر دسٲرٲٲر دسٲرٲٲر دسٲرٲٲر  
 ءٲٲٲر دسٲرٲٲر دسٲرٲٲر دسٲرٲٲر دسٲرٲٲر دسٲرٲٲر  
 ءٲٲٲر دسٲرٲٲر دسٲرٲٲر دسٲرٲٲر دسٲرٲٲر دسٲرٲٲر.

<b>Date of Issue:</b> 17 <sup>th</sup> December 2017	قٲٲٲر ءٲٲٲر: 17 ءٲٲٲر 2017
<b>Date of expiry:</b> 17 <sup>th</sup> December 2018	ءٲٲٲر ءٲٲٲر: 17 ءٲٲٲر 2018
<b>Name:</b> Yazeed Ahmed	سٲٲٲر: ءٲٲٲر ءٲٲٲر
<b>Designation:</b> Director, Environment Assessment	ءٲٲٲر: ءٲٲٲر ءٲٲٲر ءٲٲٲر ءٲٲٲر ءٲٲٲر
<b>Signature:</b>	سٲٲٲر:



Annex 5

Google Earth Photo Over Thilafushi Island





## Technical Assistance Consultant's Final Report

---

Project Number: 51077-001

February 2019

### **Maldives: Greater Male Environmental Improvement and Waste Management Project - Market Study on the Reuse of Incinerator Bottom Ash and Construction and Demolition Waste in the Maldives**

This consultant's report does not necessarily reflect the views of ADB or the Government concerned, and ADB and the Government cannot be held liable for its contents. (For project preparatory technical assistance: All the views expressed herein may not be incorporated into the proposed project's design.

Asian Development Bank

## CONTENTS

1. Project.....	5
1.1. Project Description .....	5
1.2. Objective of Technical Assistance .....	7
1.3. Scope of Technical Assistance .....	7
2. Suitable Applications for Incinerator Bottom Ash.....	8
2.1. Cement Manufacturing .....	11
2.2. Concrete Production .....	11
2.3. Masonry and Pavement Block Production .....	13
2.4. Road Construction .....	14
2.5. Land Reclamation .....	17
2.6. Coastal protection systems.....	19
3. Suitable Applications for Construction Demolition Waste.....	20
4. Review of national standards and required material characteristics.....	22
5. Stakeholder Product Acceptance and Product Requirements.....	25
6. Cost of similar construction materials and current demand .....	26
7. Forecasted demand.....	31
8. Sustainable Business Model .....	44
9. Recommendations .....	46
10. References.....	47

## TABLES

Table 1. Breakdown of Waste by Type .....	5
Table 2. Composition of Municipal Solid Waste .....	6
Table 3. Oxides and heavy metals in incinerator bottom ash <sup>2</sup> .....	9
Table 4. Effect on properties of concrete when r-IBA replaced natural aggregates .....	13
Table 5. Effect on properties of concrete when CDW replaced natural aggregates .....	21
Table 7. BS 882:1992 grading requirement for fine aggregates .....	23
Table 6. Leaching limits as set out in Council Decision 2003/33/EC .....	24
Table 8. Estimated composition by weight of CDW .....	30
Table 9. Imports of course aggregates and fine aggregates (sand).....	34
Table 10. Growth of key indicators of construction industry .....	35
Table 11. Forecast of course aggregates for 15 years (2018 - 2033).....	37
Table 12. Forecast of fine aggregates (sand) for 15 years (2018 - 2033).....	38
Table 13. Demand forecast of fine aggregates (sand) required in concrete masonry block production for 15 years (2018 – 2033).....	40
Table 14. Projection of IBA and CDW aggregates generation .....	40
Table 15. Sensitivity analysis of demand for IBA and CDW in concrete masonry block production.....	43
Table 16. Price comparison of sand used for concrete masonry block production and IBA and CDW .....	45

## FIGURES

Figure 1. Global distribution of publications on MIBA in concrete applications <sup>6</sup> .....	9
Figure 2. Results of stakeholder consultations on the reuse of IBA and CDW .....	26
Figure 3. Construction related imports by sector .....	32
Figure 4. Loans and Advances to the Private Sector by Major Sectors .....	32
Figure 5. Building permits .....	33
Figure 6. Growth of construction industry.....	35
Figure 7. Imports of course aggregates and fine aggregates (sand) over 15 years, .....	36
Figure 8. Forecast of course aggregates for 15 years (2018 - 2033).....	37
Figure 9. Forecast of fine aggregates (sand) for 15 years (2018 - 2033) .....	38
Figure 10. Demand forecast of fine aggregates (sand) required in concrete masonry block production for 15 years (2018 – 2033).....	39
Figure 11. Comparison of forecasted sand required for concrete block production against IBA and CDW generated.....	41
Figure 12. Sensitivity analysis of demand for IBA and CDW in concrete masonry block production.....	42

## ABBREVIATIONS

ADB	Asian Development Bank
CDW	Construction Demolition Waste
CIF	Cost, Insurance and Freight
IBA	Incinerator Bottom Ash
IBA (r-IBA)	Recycled Incinerator Bottom Ash
MSW	Municipal Solid Waste
MSWI	Municipal Solid Waste Incinerator
SWM	Solid Waste Management
tpd	Tons per day
WTE	Waste-to-Energy
TA	Technical Assistance
RCA	Recycled Concrete Aggregates
RC	Recycled Aggregates
STO	State Trading Organization



# 1. Project

## 1.1. Project Description

Greater Male' is centrally located in Maldives and is the capital city of the nation. The Male' island and its 32 inhabited islands are categorized as Zone 3 in the National Solid Waste Management Policy. Greater Male' Region lack a proper waste management system. For the last 30 years, waste has been collected, transferred by sea, dumped and burnt at an open dump site at Thilafushi, an island 6km away from Male'. The current practice of waste management poses an environmental and public safety issue. Some waste, often in plastic bags, are lost to the sea during transportation and toxic leachate from the Thilafushi dump site contaminate the ground water. The smoke from burning of waste causes air pollution. The current practice of waste management is not sustainable.

The Greater Male' region (Zone 3) produces 774 tons per day (tpd) of mixed solid waste. The breakdown of waste is given in Table 1 and Table 2 shows the composition of Municipal Solid Waste (MSW). Due to the rapid urbanization and tourism development in Zone 3, it is expected the waste generation would increase to 924 tpd by 2022.

*Table 1. Breakdown of Waste by Type*

<b>Type</b>	<b>Amount</b>	
	<b>(tons per day)</b>	
Construction Demolition		
Waste	530	68%
Household	149	19%
Resort	48	6%
Commercial	27	3%
Airport	9.3	1.2%
Industrial	6	0.8%
Market	2.5	0.3%
Hazardous	1.5	0.2%
End-of-life vehicles	0.65	0.1%

Table 2. Composition of Municipal Solid Waste

<b>Type of Municipal Solid Waste</b>	
Organic	53%
Paper and cardboard	12%
Plastic	11%
Hazardous (medical)	8%
Metal	3%
Glass	3%
Others	11%

As an alternative to the current unsustainable practice of burning mixed solid waste, Greater Male' Environmental Improvement and Waste Management Project (Project), supported by the Asian Development Bank (ADB), is going to strengthen the solid waste management (SWM) in Zone 3. The Project will establish an integrated SWM system including collection, transfer, treatment using advanced waste-to-energy (WTE) technology, disposal, recycling, dumpsite closure and remediation, public awareness in reduce-reuse-recycle (3R), and strengthening institutional capacities for service delivery and environmental monitoring. The Government will implement the Project in two phases;

**Phase 1** includes Construction Demolition Waste (CDW) processing facility (200 tpd capacity).

**Phase 2** will consist of a WTE incineration of 500 tpd of Municipal Solid Waste (MSW) and the flammable fraction of the CDW

The incineration process reduces the waste to energy, Incinerator Bottom Ash (IBA) and fly ash. The fly ash will be disposed in a landfill. The IBA can also be disposed in a landfill. However, it is expected 100 to 125 tpd of IBA would be generated and land scarcity in Zone 3 limits the disposal of IBA in landfills. Alternatively, IBA could be treated further to produce recycled IBA (r-IBA) and reused as a building material.

CDW is mixed waste generated from construction and demolition activities. Soil and sand is not considered as CDW in this report as it is usually reused as backfill material. Disposal of CDW in landfills is also challenging due to land scarcity. CDW can be processed as recycled aggregates that could be used in various applications in the construction industry.

## 1.2. Objective of Technical Assistance

The objective of this assignment is to assess the potential market for IBA and CDW reuse in the Maldives.

## 1.3. Scope of Technical Assistance

The scope of this Technical Assistance (TA) is to conduct a market assessment for potential IBA and CDW reuse in the Maldives. Current use of aggregates with the aim of identifying potential applications, required national standards, costs, and current and projected demand for recycled IBA and CDW in the Maldives is analyzed. Detailed tasks of this assignment include:

- (i) Identify suitable applications for treated IBA and CDW reuse in the Maldives through literature review and surveys.
- (ii) Review applicable national standards for the reuse of treated IBA and CDW for the potential applications as identified in (i) and summarize the required material characteristics (e.g. chemical, physical).
- (iii) Conduct interviews/surveys with key stakeholders to understand their views on potential reuse, product requirements, and willingness to pay for treated IBA and CDW.
- (iv) Collect information on cost and demand of similar construction materials (to IBA and CDW) currently used in the Maldives.

- (v) Conduct a market demand analysis for reusing treated IBA and CDW in the Maldives including projections for next 5, 10 and 15 years
- (vi) Recommend possible ways/alternatives for maximize IBA and CDW demand/reuse and sustainable business models for the Greater Male context.
- (vii) Prepare comprehensive report on the activities (i) to (vi) with key recommendations for IBA treatment and CDW plant design and operation

## 2. Suitable Applications for Incinerator Bottom Ash

Incineration of MSW releases the energy during combustion. The waste reduces in weight by about 70%. IBA accounts for about 80% of the incombustible residue left <sup>1</sup>. The remaining of the residue is fly ash. Incombustible metals, glasses, ceramics, slag and sand mixture form as IBA and is rich in heavy metals, chlorides, oxides and organic pollutants. IBA require removal of ferrous and non-ferrous metals and further treatment to enhance its reusability. The type of treatment process adopted affects the leaching property and consequently the reusability of r-IBA. Common oxides and heavy metals found in IBA are given in Table 3. The composition of the oxides and heavy metals depend on the characteristics of the MSW but SiO<sub>2</sub> is generally the most abundant oxide in IBA<sup>2</sup>.

IBA is similar in its size and appearance to aggregates and hence can be used as a substitute to aggregates in applications aggregates are required. The main factors affecting the reuse of IBA is the suitability of IBA for treatment and processing, the

---

<sup>1</sup> Lynn, C., Dhir, R., & Ghataora, G. (2016). Municipal incinerated bottom ash characteristics and potential for use as aggregate in concrete. *Construction and Building Materials*, 504-517.

<sup>2</sup> Lam, C. H., Ip, A. W., Barford, J. P., & McKay, G. (2010). Use of Incineration MSW Ash: A Review. *Sustainability*, 1943-1968.

attainability of required properties for a given application, and the environmental impact from the reuse of IBA <sup>3</sup>.

Reuse of IBA has been studied for the past 40 years. Lynn, Dhir, & Ghataora (2016) studied 76 publications published since 1979 over 18 countries<sup>4</sup> (Figure 1). Reuse of IBA is most prevalent in Europe. In Asia, reuse of IBA is prevalent in countries like Taiwan, Singapore and Japan where land is scarce.

Table 3. Oxides and heavy metals in incinerator bottom ash<sup>2</sup>

Oxides		Heavy Metals	
SiO <sub>2</sub>	K <sub>2</sub> O	Ag	Mn
Al <sub>2</sub> O <sub>3</sub>	Na <sub>2</sub> O	As	Ni
CaO	SO <sub>3</sub>	Ba	Pb
Fe <sub>2</sub> O <sub>3</sub>	P <sub>2</sub> O <sub>5</sub>	Cd	Se
MgO	TiO <sub>2</sub>	Co	Zn
		Cr	Sn
		Cu	Sr
		Hg	V

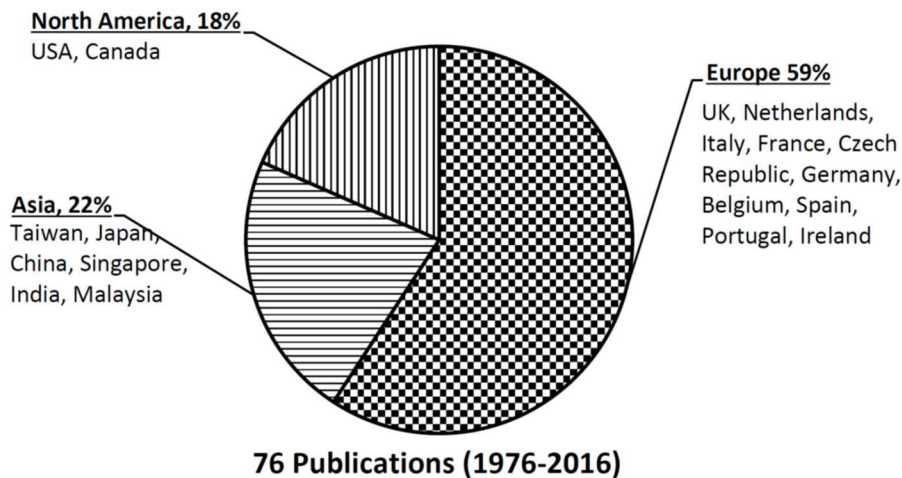


Figure 1. Global distribution of publications on MIBA in concrete applications<sup>4</sup>

<sup>3</sup> Lam, C. H., Ip, A. W., Barford, J. P., & McKay, G. (2010). Use of Incineration MSW Ash: A Review. *Sustainability*, 1943-1968.

<sup>4</sup> Lynn, C., Dhir, R., & Ghataora, G. (2016). Municipal incinerated bottom ash characteristics and potential for use as aggregate in concrete. *Construction and Building Materials*, 504-517.

There are two main literature that had collected the fragmented studies done and reviewed them in a single work. The work of Lam, Ip, Barford, and McKay<sup>5</sup> categorized the utilization of IBA and fly ash into seven different applications; cement and concrete production, road construction, glasses and ceramics, agriculture, stabilizing agent, adsorbents and zeolite production. Incinerator fly ash is utilized as a stabilizing agent and in zeolite production. Since the scope of this TA is only IBA, applications for incinerator fly ash will not be discussed. Lynn, Dhir, & Ghataora, (2016) had reviewed 76 publications and focused the work on the reuse of IBA as aggregates in concrete applications<sup>6</sup>. Additionally, there is literature that support the utilization of IBA in land reclamation works in Singapore and Japan. The utilization of r-IBA as raw materials in glass, ceramic and blasting grit production is supported by studies<sup>5</sup>. However, there is no glass and ceramic production industry in Maldives and hence reuse of r-IBA for glass and ceramic production is not a practical application in Maldives.

Existing literature was reviewed and the following utilizations of r-IBA are evaluated to determine their potential in Maldives.

- i. Cement manufacturing
- ii. Concrete production
- iii. Masonry and pavement block production
- iv. Road construction
- v. Land reclamation
- vi. Coastal protection systems

---

<sup>5</sup> Lam, C. H., Ip, A. W., Barford, J. P., & McKay, G. (2010). Use of Incineration MSW Ash: A Review. *Sustainability*, 1943-1968.

<sup>6</sup> Lynn, C., Dhir, R., & Ghataora, G. (2016). Municipal incinerated bottom ash characteristics and potential for use as aggregate in concrete. *Construction and Building Materials*, 504-517.

## 2.1. Cement Manufacturing

Calcareous materials like limestone and argillaceous materials like shale and clay are raw materials for cement production. These raw materials provide the reactants CaO, SiO<sub>2</sub>, Fe<sub>2</sub>O<sub>3</sub> and Al<sub>2</sub>O<sub>3</sub> required for cement production. These oxides are also present in IBA (Table 3). Hence, IBA can be used as a substitute raw material in cement manufacturing<sup>7</sup>. However, corrosion of the cement kiln due to chloride ions and heavy metals in IBA can limit its reusability in cement manufacturing. Treatment of IBA is essential to reduce the effects of chloride and heavy metals. Pan, Huang, Kuo, and Lin used the washing treatment process and the cement produced conformed to the Chinese National Standards of Type II cement <sup>8</sup>, suggesting the technical feasibility of utilizing treated IBA in cement production.

Maldives does not have a cement manufacturing industry. However, exporting the treated IBA to a cement manufacturer in an Asia is a possible option that could be explored. The requirements of Basel Convention on the Control of Transboundary Movements of Hazardous Wastes and Their Disposal should be met for exporting the treated IBA.

## 2.2. Concrete Production

Treated IBA can be used as coarse aggregates and fine aggregates in concrete. The physical characteristics of IBA is an important factor that defines the properties of concrete made using IBA.

One of the physical properties of IBA that influence other physical properties of IBA and consequently the properties of concrete made with treated IBA is porosity. The porosity of IBA is higher than that of natural aggregates. Consequently, the absorption of IBA is

---

<sup>7</sup> Lam, C. H., Ip, A. W., Barford, J. P., & McKay, G. (2010). Use of Incineration MSW Ash: A Review. *Sustainability*, 1943-1968.

<sup>8</sup> Pan, J. R., Huang, C., Kuo, J.-J., & Lin, S.-H. (2008). Recycling MSWI bottom and fly ash as raw materials for Portland cement. *Waste Management*, 1113-1118.

higher. An averaged value of the water absorption is 9.7% and ranges over 2.4 – 15.0 %<sup>9</sup>. The porosity and absorption influence the bond between the cement paste and IBA. Aggregates are used as a fill material for concrete and can take up three quarters of the volume of concrete. Hence the high porosity and absorption of IBA used in concrete increases the porosity and absorption of the hardened concrete.

The high porosity of IBA contributes to the low specific gravity of IBA. The average specific density of IBA is 2.32<sup>8</sup>. This is comparably less than the typical specific density of natural aggregates. The specific density of natural aggregates is between 2.6 and 2.7<sup>10</sup>. The specific density depends on the treatment process as well.

Table 4 summarizes Lynn, Dhir, and Ghataora's review of the 76 publications focusing on the reuse of IBA in concrete<sup>9</sup>. As observed from Table 4, the performance of concrete produced with IBA is lower than concrete with natural aggregates. The workability is reduced due to high absorption of IBA. The compressive strength and tensile strength is lower. The current construction practices are very traditional in Maldives. It is a common practice to add water on site to the concrete mix to improve the workability. However, uncontrolled addition of water can further reduce the compressive strength of concrete. A reduction in compressive strength is translated to a reduction in flexural tensile strength of concrete. Concrete with lower tensile strength is susceptible to early cracking. Furthermore, the presence of chloride ions in IBA with close proximity to the reinforcing steel increases the risk of reduced durability. The existing literature lack a focus on long-term durability.

The practical utilization of IBA in concrete applications is in the early stages<sup>9</sup>. Due to the poor performance of concrete with IBA as aggregates, unreliable workmanship and the associated risks and lack of long-term durability studies, the reuse of r-IBA in structural concrete applications in Maldives is not recommended.

---

<sup>9</sup> Lynn, C., Dhir, R., & Ghataora, G. (2016). Municipal incinerated bottom ash characteristics and potential for use as aggregate in concrete. *Construction and Building Materials*, 504-517.

<sup>10</sup> Neville, A. M., & Brooks, J. J. (2010). *Concrete Technology*. Harlow: Pearson Education Limited.



Table 4. Effect on properties of concrete when r-IBA replaced natural aggregates

Property of Concrete	Change in property when aggregates replaced with IBA
Slump	Reduces
Cohesiveness	Remains cohesive
Segregation	No segregation
Bleeding	Bleeding reduces
Setting time	Increases
Compressive strength	Decreases
Tensile strength	Decreases
Elastic modulus	Decreases
Shrinkage	Increases
Creep	No significant change
Absorption	Increases
Chloride corrosion	Higher risk
Sulfate attack	No expansion due to sulfate attack
Carbonation resistance	Carbonation depth decreases

### 2.3. Masonry and Pavement Block Production

Concrete masonry blocks are extensively used in the construction industry. They are mainly used in non-load bearing masonry walls. Concrete masonry blocks used for majority of projects are locally produced. Sand quarried from lagoons are used as fine aggregates in block production. Use of local quarried sand is not a sustainable use of natural resources. Furthermore, the chloride content of the blocks due to the sand quarried from the sea floor can be high. However, supply of local quarried sand is limited and hence some large-scale block producers depend on imported sand.

The unit weight of masonry blocks with IBA is less than normal masonry blocks. This is due to the lower specific gravity of IBA. Since, the absorption of IBA is higher, the water demand during production is higher. The compressive strength of masonry and pavement

blocks with IBA is lower. However, since the strength demanded from masonry products is lower, the target strength is achieved in non-load bearing, load bearing, paving and interlocking blocks<sup>11</sup>. Fire resistance performance is comparable to the products made with natural aggregates and no adverse shrinkage cracking is observed when IBA is used as a fine aggregate. Additionally, concrete paving blocks made with IBA exhibited excellent slip resistance and can be classified as having low potential for slip as per BS EN 1333<sup>11</sup>.

Furthermore, full-scale operations had been conducted with masonry and pavement blocks made with IBA. There has been reports of spalling in projects carried out in the nineties. This is due to corrosion of the ferrous metal in IBA. However, with advanced treatment methods, the problem of spalling can be easily resolved. Most of the full-scale operations can be deemed successful<sup>11</sup>.

Quality of masonry and pavement blocks made with IBA as aggregates is slightly inferior to similar products with natural aggregates. However, the requirements of masonry and pavement products is less than those of structural concrete. Therefore, review of literature suggests that the performance of the products with IBA can be of acceptable standards<sup>11</sup>.

Concrete masonry blocks are extensively used in non-structural applications in Maldives and the reuse of r-IBA is a more sustainable use of materials than the current use of chloride rich quarried sand. Therefore, utilization of r-IBA in concrete masonry and pavement block production has high potential in Maldives.

## 2.4. Road Construction

Reuse of IBA in road construction is one of the applications where IBA is utilized most in Europe. The research of IBA utilization in road construction is well progressed and

---

<sup>11</sup> Lynn, C., Dhir, R., & Ghataora, G. (2016). Municipal incinerated bottom ash characteristics and potential for use as aggregate in concrete. *Construction and Building Materials*, 504-517.

translated to field applications in countries like Belgium, Denmark, Germany and Netherlands<sup>12</sup>.

A typical road cross-section has the wearing course as top surface, the base course and then the sub-base layer. Interlocking concrete blocks has been mostly used for the wearing course layer in Maldives though the use of bituminous asphalt in new roads is increasing. The sub-base layer is constructed on the subgrade, compacted natural soil as the foundation for the road. The base course and the sub-base is constructed with graded aggregates. Treated IBA can replace the natural aggregates used for the base course and sub-base layer<sup>12</sup>. IBA can be used in unbound form, hydraulically bound or bitumen bound form.

Hydraulically bound IBA is often stabilized with cement or lime when used in base layers. Singh and Kumar studied the geotechnical properties of MSWI ash mixed with cement<sup>13</sup>. The particle sizes of the MSWI ash used by Singh, et.al ranges from 75 microns to 1.18mm and suggests the study used IBA. Singh, et.al found that the California Bearing Ratio (CBR) value, Unconfined Compressive Strength (UCS) and Split Tensile Strength (STS) of MSWI increases when mixed with cement and suggests the MSWI mixed with cement can be used as an alternative material for road bases. However, the study of Singh, et.al did not focus on the environmental impacts of MSWI when used in ground works. A similar study in China also indicate the IBA mixed with cement satisfy the strength requirements for use on base and sub-base layers of heavy highway traffic<sup>14</sup>. However, the use of cement can increase the cost of the road construction.

Lynn, Ghataora, and Dhir had done an evaluation of the global experimental data on the use of IBA in road construction<sup>15</sup>. The analysis confirms that unbound IBA meets the grading requirement after standard processing and can be compacted well with

---

<sup>12</sup> Lam, C. H., Ip, A. W., Barford, J. P., & McKay, G. (2010). Use of Incineration MSW Ash: A Review. *Sustainability*, 1943-1968.

<sup>13</sup> Singh, D., & Kumar, A. (2017). Geo-environmental application of municipal solid waste incinerator ash stabilized with cement. *Journal of Rock Mechanics and Geotechnical Engineering*, 370-375.

<sup>14</sup> Tang, Q., Gu, F., Chen, H., Lu, C., & Zhang, Y. (2018). Mechanical Evaluation of Bottom Ash from Municipal Solid Waste Incineration Used in Roadbase. *Advances in Civil Engineering*.

<sup>15</sup> Lynn, C. J., Ghataora, G. S., & Dhir, R. K. (2017). Municipal incinerated bottom ash (MIBA) characteristics and potential for use in road pavements. *International Journal of Pavement Research and Technology*, 185-201.

performance similar to that of sandy gravel. Unbound IBA meets the requirements of a material suitable for sub-base and is widely used in Denmark and Netherlands. IBA bound with a stabilizing agent like cement or lime can be processed to satisfy the requirements of a sub-base or base-course material by adjusting the binder content. Laboratory results of hydraulically bound IBA shows low density and elastic modulus. However, performance measured in full-scale projects suggests hydraulically bound IBA can be satisfactorily used despite lower laboratory results. Additionally, there are full-scale projects that provides evidence that low contents of IBA can be used to form bituminous bound bases and wearing course layers.

Environmental impact of the IBA used in road construction is as important as the mechanical properties. Lynn, Ghataora, and Dhir, had done an evaluation of global literature published on the environmental impacts of IBA as a road construction material<sup>16</sup>. Lynn, Ghataora, and Dhir's analysis concluded that IBA in unbound form poses the highest risk of leaching heavy metals and contaminants to the ground water but the risk could be minimized by treatment prior to utilization<sup>16</sup>. However, IBA bound with cement or bitumen restricts the leaching and the leachate concentrations were below the utilization and water quality limits. Therefore, the environmental impacts of the reuse of IBA in road construction does not limit its utilization.

Roads in most islands in Maldives are not leveled and paved. Only the capital city Male', Hulhumale' and Villimale' have all the roads paved, either with interlocking concrete paving blocks or asphalt. Some of the larger islands like Laamu Atoll Gan, Seenu Atoll Gan and Fuvahmulah have the main road paved with asphalt. The islands without paved roads create an opportunity for the reuse of IBA. Currently, there are eight road development projects in eight different islands in the tender phase. Similarly, future airport developments are potential applications for the utilization of IBA. However, according to Regional Airports there are no long-term development plans and the recent increase in new airports was politically rationalized.

---

<sup>16</sup> Lynn, C. J., Ghataora, G. S., & Dhir, R. K. (2018). Environmental impacts of MIBA in geotechnics and road applications. *Environmental Geotechnics*, 31-55.

## 2.5. Land Reclamation

The utilization of IBA in land reclamation is published in literature. However, this application is only limited to countries like Singapore and Japan where land is scarce.

In Singapore, IBA and marine clay originating from excavation works are solid wastes. It was proposed to use a mixture of stabilized IBA and marine clay as a fill material for land reclamation<sup>17</sup>. The mechanical properties and environmental impact assessments were tested. The literature concluded the reuse of IBA and marine clay matrix is feasible from both geotechnical and environmental perspective<sup>18</sup>. However, it should be highlighted that the polymer-based cementitious stabilizer Chemlink SS-331H is a proprietary product.

In Japan, approximately 78% of MSW that is disposed in coastal landfill sites is MSWI ash and 20% of the MSW is disposed in coastal landfills, mostly located in port areas of Tokyo, Nagoya and Osaka<sup>19</sup>. Various studies had showed the geotechnical properties of the landfills improved. Nguyen, Inui, Ikeda, and Katsumi had taken waste mixture samples just before being disposed at coastal landfill site in Osaka Bay area and studied the time dependent geotechnical properties of waste mixtures submerged in landfill leachate or seawater. The composition of the waste mixture was approximately 50% of MSWI ash, 30% of gravel materials like slags, and 20% surplus soil. The study concluded that the shear strength increases and deformation decreases with time and hence waste mixture layers studied could be used as foundation layers with adequate bearing capacity after closure of the coastal landfill sites<sup>20</sup>.

---

<sup>17</sup> Guo, L., & Wu, D. -Q. (2018). Study of leaching scenarios for the application of incineration bottom ash and marine clay for land reclamation. *Sustainable Environment Research*, 396-402.

<sup>18</sup> Guo, L., & Wu, D.-Q. (2017). Study of recycling Singapore solid waste as land reclamation filling material. *Sustainable Environment Research*, 1-6.

<sup>19</sup> Nguyen, L. C., Inui, T., Ikeda, K., & Katsumi, T. (2015). Aging effects on the mechanical property of waste mixture in coastal landfill sites. *Soils and Foundations*, 1441-1453.

<sup>20</sup> Nguyen, L. C., Inui, T., Ikeda, K., & Katsumi, T. (2015). Aging effects on the mechanical property of waste mixture in coastal landfill sites. *Soils and Foundations*, 1441-1453.

Land reclamation activities had rapidly increased over the last five years with several islands being reclaimed as a solution to land scarcity. Sand for reclamation is quarried from borrow sites in lagoons.

The reuse of IBA as a landfill material can be a potential alternative to the use of natural sand dredged from the lagoons. However, large quantities of sediments are required for some land reclamation projects and IBA generated might not be adequate for a single project. However, there is the opportunity for blending stabilized IBA with natural sediments during land reclamation. Further research is required to support the reuse of IBA as a blended material in land reclamation.

The duration and frequency of land reclamation is different to IBA generation. Frequency of reclamation projects are discrete and the duration is relatively shorter compared to the large volume of sediments mobilized. However, IBA generation is more continuous and subjected to maturation period as well. If r-IBA is planned to use, large volumes of IBA might be required to be stored for a long period of time. Therefore, even though the reuse of IBA in land reclamation or land filling might be a technically potential application, there might be operational limitations.

## 2.6. Coastal protection systems

Maldives being a coastal country, reuse of IBA in coastal protection systems can be a potential application. However, literature review revealed that the reuse of IBA in coastal protection systems is an area where there is a gap in literature.

One of the applications for reuse of IBA can be in concrete for quay walls and jetties. However, these are structural applications and due to inadequate performance of concrete with IBA, reuse of IBA in construction of quay walls and jetties is not recommended.

Crushed rocks are commonly used as revetments and breakwaters in Maldives. Alternatively, tetrapods made from concrete can be used and since it is not a structural application IBA can be used as aggregates in tetrapod production. However, durability is a concern and require further research to fully validate this application. A solution to ensure durability can be to design a tetrapod with an inner core made of compacted and hydraulically bound IBA and a more durable shell made of concrete with natural aggregates.

An alternative to tetrapod could be geo-bags. Currently sand, often sourced close to the project site is used as a fill material. Since, IBA can be used in road base layers with acceptable leachate performances, stabilized IBA can potentially be used as a fill material for geo-bags. However, this application is subjected to further research and the intermittent frequency of coastal protection projections should be considered.

### 3. Suitable Applications for Construction Demolition Waste

Recycling of CDW is practiced widely in some countries. In some countries, approximately 90% of the CDW are recycled<sup>21</sup>. BS 8500 (2002) defines two types of aggregates; Recycled Concrete Aggregates (RCA) and Recycled Aggregates (RC). RCA should have minimum 95% crushed concrete and RC is defined as 100% masonry based crushed aggregates. The quality of both types of CDW aggregates is poor compared to natural aggregates. This is primarily due to the mortar adhered to the natural aggregates. The production method influence the quality and composition of CDW aggregates.

Acceptability of CDW aggregates depends on the properties of fresh and hardened concrete incorporating CDW aggregates more than the properties of CDW aggregates itself. Table 5 summarizes the properties of fresh and hardened concrete with CDW aggregates compared to concrete with natural aggregates. As observed from Table 5 the properties of concrete with CDW aggregates is lower than conventional concrete. However, Brito and Saikia had proved that when the partial replacement ratio is less than 30%, the properties of CDW incorporated concrete is comparable to that of conventional concrete and both normal and high-strength concrete could be prepared using CDW aggregates<sup>21</sup>. Furthermore, Brito and Saikia claim that properties of concrete with CDW aggregates could be improved through the mix design<sup>21</sup>.

Compared to IBA, CDW aggregates has more potential for reuse in structural concrete in Maldives. The majority of buildings have a concrete frame as the structural form and quay walls and jetties are made of concrete as well. RCA can be used to produce structural concrete and RC can be incorporated into concrete masonry block making. However, since construction of most residential buildings follow traditional methods and concrete is mostly batched volumetrically on site, the risk is high for the reuse of CDW as aggregates in concrete of residential buildings. The risk can be reduced when concrete mixes are designed and tested and batched using a batching plant. Currently, there are very few

---

<sup>21</sup> Brito, J. d., & Saikia, N. (2013). *Recycled Aggregate: Use of Industrial, Construction and Demolition Waste*. London: Springer



ready-mix concrete producers. Additionally, many old buildings that are being demolished had used sand quarried from lagoons and coral fragments as aggregates. Consequently, the concrete is rich in chloride ions and had caused severe corrosion in old buildings and is one of the main reasons for demolition. Hence, reuse of aggregates made from old buildings constructed using coral fragments would lead to corrosion and would not be accepted by consultants in the industry. Therefore, CDW aggregates should be used in Maldives with caution.

*Table 5. Effect on properties of concrete when CDW replaced natural aggregates*

<b>Property of Concrete</b>	<b>Change in property when aggregates replaced with IBA</b>
Workability	Reduces
Density	Lower
Air-content	Increases
Bleeding	Reduces
Compressive strength	Lower
Split tensile strength	Lower
Flexural strength	Lower
Modulus of Elasticity	Lower
Creep	Increases
Drying shrinkage	Increases
Water absorption	Increases
Chloride permeability	Increases

#### 4. Review of national standards and required material characteristics

Construction Act of 2017 (Act No. 4/2017) and Environment Protection and Preservation Act of 1993 (Act No. 4/93) are the two legislations that could be related to IBA and CDW.

Environment Protection and Preservation Act confers power on a ministry responsible for environment to formulate policies and regulations. Environment Protection and Preservation Act briefly states in clause 7 and 8 that waste, oil and toxic material should be disposed in areas designated by the government, should not damage the environment and if waste burning is adopted it should not harm human health. Ministry of Environment has formulated a National Solid Waste Management Policy in 2008 and revised it in 2015. Ministry of Environment has also issued a Waste Management Regulation (Regulation No. 2013/R-58). Consultation with relevant staff of Ministry of Environment revealed that there are no specific environmental national standards related to IBA and CDW. However, clause 3.1 of Annex 1 of Waste Management Regulation states that International standards should be referred to in cases where there are no national standards. There are no universal standards. Standards differ in each country and reflect factors unique to the specific country. Table 7 shows European Union's minimum waste acceptance criteria for the different categories of waste<sup>22</sup>.

Construction Act sets the general principles and confers the power on the ministry to issue regulations to control production, import, testing and use of construction materials. However, currently there are no regulations formulated. Material testing and ensuring compliance to specifications is not widely practiced in Maldives. In circumstance where testing is conducted, only the grading of aggregates and compressive strength of concrete and sometimes masonry blocks is tested. However, when used in non-load bearing walls compressive strength of blocks is not critical. There is no specific standard followed by all the professionals in the construction industry. Some of the standards

---

<sup>22</sup> Liu, A., Lin, W. Y., & Wang, J. Y. (2015). A review of municipal solid waste environmental standards with a focus on incinerator residues. *International Journal of Sustainable Built Environment*, 165–188.

followed include Australian Standards, British Standards, Indian Standards and standards of American Society for Testing and Materials (ASTM). There are no specific national standards on IBA or CDW. The grading requirements often followed in Maldives is given in Table 6.

*Table 6. BS 882:1992 grading requirement for fine aggregates*

<b>Sieve size</b>	<b>Percentage by mass passing sieve</b>
10 mm	100
5 mm	89-100
2.36 mm	60-100
1.18 mm	30-100
600 μm	15-100
300 μm	5-70
150 μm	0-150*

\* For crushed rock sands the permissible limit is increased to 20%



## 5. Stakeholder Product Acceptance and Product Requirements

Stakeholders were identified and interviewed individually. Maldives National Association of Construction Industry (MNACI), contractors, masonry block producers and consultants were interviewed. There were challenges in arranging interviews as some were not available for the interview. Twelve participants were interviewed. Three main questions were asked after a brief explanation of the project, potential applications of r-IBA and processed CDW, and the characteristics and performance of IBA and CDW in various applications. Figure 2 shows the results of the interview. The general response was good with 75% viewing the reuse of IBA and CDW as a good initiative and 65% were willing to buy and use the product. However, almost all the participants imposed a condition on the willingness to buy or use the product. The willingness of potential stakeholders was subjected to the compliance with standard requirements. Some of the participants (25%) view that if the performance of the product made using IBA or CDW satisfy the standards and is similar to the performance of product made with natural aggregates the price of IBA or CDW could be similar to that of natural aggregates. However, 35% of the participants believe the price of IBA or CDW should be 40 – 60% of the price of natural aggregates. A quarter of the participants did not respond to the price question.

It was observed that most of the contractors believe the use of IBA or CDW depend on the approval of consultants and did not suggest any product requirements, other than strength. However, consultants had given additional requirements such as absorption percentage and grading. In general, all participants believed that IBA and CDW aggregates should conform to international standards.

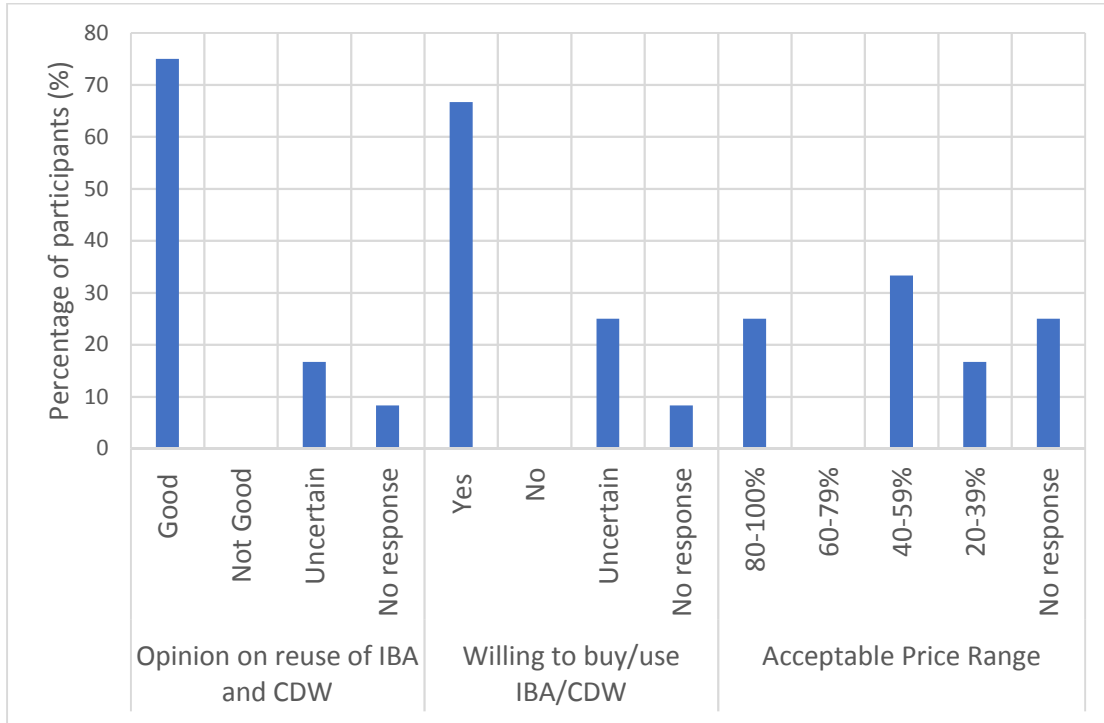


Figure 2. Results of stakeholder consultations on the reuse of IBA and CDW

## 6. Cost of similar construction materials and current demand

IBA and CDW are substitute products for coarse and fine aggregates used in construction industry. Hence, the demand for IBA and CDW products are expected to be similar to the demand for aggregates. Aggregates is one of the major materials used in construction. The current demand for aggregates should be reflected by the demand in the construction industry. Hence, the trends in the construction industry was first analyzed. The gauges used to determine the current demand is the construction related imports, loans to construction industry, and the building permits issued.

The construction industry is performing progressively as indicated by the gauges. In the first quarter of year 2018, loans for construction of residential housing, guest houses and new resorts observed an annual increase of 19%. During the first half of year 2018 the annual growth in credit to construction industry was registered as 23% and the growth maintained in the third quarter.

Construction related imports is another indicator of the demand in construction industry. The construction related imports increased 51% during the first half of the year 2018 and during the third quarter the growth was 39%. Statistics provided by Maldives Customs Service shows that about 792,800 tons of coarse aggregates and 495,300 tons of fine aggregates (sand) were imported to Maldives in year 2018 (Table 9). The value of imports of aggregate amounts to USD 48.9 million.

The demand for masonry blocks was captured through interviews. Maldives National Association of Construction Industry (MNACI), one of the largest contractors in Maldives and one of the current major suppliers of concrete masonry blocks to the Greater Male' Region were interviewed. Attempts to access archived information of Maldives Road Development Corporation was not successful. Maldives Road Development Corporation, before its recent liquidation, used to be one of the largest concrete masonry and pavement block production facility in the country. Currently, there are several block producers. Majority of block production facilities operate on a small scale and production is limited to approximately 1000 to 3500 blocks per day. Some of the large contractors operate their own production facilities and produce quantities sufficient for their own projects. Small scale block producers use local sand while in large-scale production, imported manufactured sand is used but local sand is also used to a limited extent.

The composition of the masonry block varies. Some production facilities had adopted a volumetric ratio of 1 units of cement to 5 or 6 units of sand while some production facilities can increase the sand content. Hollow rectangular blocks and solid rectangular blocks are manufactured in Maldives. The width of the blocks currently produced in the market is four inches.

The market rate of unit cost of local sand is approximately USD/kg 0.015. The typical market rate of four inch hollow blocks produced using local sand is USD 0.39 per block, though USD 0.34 per block is available from some of the large-scale producers. The unit price of four inch solid blocks produced using local sand is US 0.52. However, unit price of four-inch masonry hollow blocks produced using imported manufactured sand is USD

0.97. The average production rate of one of the major suppliers interviewed is 15,000 blocks per day. Considering the known masonry block producers in Male' and Hulhumale' and their observed production, it is estimated that approximately 83,000 blocks are produced per day in Male' and Hulhumale'. Estimating 3.5 kg of sand is required per block, production at this rate requires approximately 291 tpd of sand in Male' and Hulhumale'. Adopting 20% as the optimum aggregate replacement level<sup>23</sup>, it is estimated 58 tpd of r-IBA are required. The estimated IBA generation of 100 – 125 tpd is more than the quantity required as of year 2019. The demand for r-IBA could be increased through means of government controls on the use of local sand quarried from lagoons.

The current CDW generation is 530 tpd. The proportion that could be recycled and reused is 482 tpd<sup>24</sup>. However, the CDW processing facility proposed to be implemented has a capacity of 200 tpd. The composition of the CDW (Table 8) shows 42.6% of CDW arriving at Male' waste transfer station is concrete and 41% is sand and soil, and 8.1% is rock and gravel resulting from excavation<sup>23</sup>. It is assumed that sand and soil from excavation works will be reused for backfill and landscape works and thus is excluded from the scope of the TA. Therefore, the recycled concrete yield of the processing facility operating at maximum capacity can be estimated as 85 tpd (42.6% of CDW). However, to be conservative for demand estimation purposes, the yield of recycled aggregates is assumed to be same as 200 tpd, the maximum capacity of the processing plant.

There is no data in the feasibility study<sup>23</sup> that suggests concrete and masonry walls are identified separately. On the contrary it seems structural concrete and masonry walls are identified as a single group of concrete. The properties of aggregates derived from structural concrete and concrete masonry walls differ significantly and would influence the potential application for reuse of CDW and the corresponding demand. Additionally, many old buildings that are being demolished had used sand quarried from lagoons or

---

<sup>23</sup> Lynn, C., Dhir, R., & Ghataora, G. (2016). Municipal incinerated bottom ash characteristics and potential for use as aggregate in concrete. *Construction and Building Materials*, 504-517.

<sup>24</sup> Water Solutions and Kocks Ingenieure. (2018). *Feasibility Study for an Integrated Solid Waste Management System for Zone III and Preparation of Engineering Design of the Regional Waste Management Facility at Thilafushi*.



beaches and coral fragments as aggregates. Consequently, the concrete is rich in chloride and had caused severe corrosion and cracking in old buildings. One of the main reasons for demolition is structural damage due to corrosion. Reuse of aggregates made from old buildings constructed using coral fragments would lead to corrosion. Given the uncertainty, it is recommended the concrete processed at the CDW processing plant to be crushed and used as sand for concrete masonry block making. Therefore, it can be assumed that 200 tpd of sand would be generated as recycled concrete.

Approximately 291 tpd of sand is required for block production in Male' and Hulhumale'. The current demand for sand (fine aggregates) in block production is less than the generation of 200 tpd of recycled aggregates and 100 – 125 tpd IBA, out of which 58 tpd can be used for replacement of sand.

Table 8. Estimated composition by weight of CDW<sup>25</sup>

### Estimated Composition by Weight for All Loads

<b>Paper</b>	<b>0.5%</b>		<b>Roofing</b>	<b>0.0%</b>
Unwaxed OCC	0.5%		Roofing	0.0%
RC Paper	0.0%		RC Roofing	0.0%
<b>Plastic</b>	<b>0.5%</b>		<b>Insulation</b>	<b>0.0%</b>
Non-bag Film	0.5%		Insulation	0.0%
Polystyrene Packaging	0.0%		RC Insulation	0.0%
Rigid Plastic	0.0%		<b>Wood</b>	<b>7.1%</b>
RC Plastic	0.0%		Clean Recyclable Lumber, Pallets, Crates	7.1%
<b>Metal</b>	<b>0.2%</b>		Other Untreated & Recyclable Wood	0.0%
Major Appliances	0.0%		Painted, Stained, Treated Wood	0.0%
HVAC Ducting	0.0%		RC Wood	0.0%
Other Ferrous & Non-Ferrous	0.0%		<b>Gypsum</b>	<b>0.0%</b>
RC Metal	0.2%		Clean Gypsum Board	0.0%
<b>Organic</b>	<b>0.0%</b>		Painted Gypsum Board	0.0%
Prunings, Trimmings, Branches, Stumps	0.0%		RC Gypsum	0.0%
RC Organic	0.0%		<b>Misc. C&amp;D</b>	<b>0.0%</b>
<b>Carpet</b>	<b>0.0%</b>		<b>Glass</b>	<b>0.0%</b>
Carpet	0.0%		<b>Electronics</b>	<b>0.0%</b>
Carpet Padding	0.0%		<b>HHW</b>	<b>0.0%</b>
RC Carpet	0.0%		<b>Special</b>	<b>0.0%</b>
<b>Aggregates &amp; Dirt</b>	<b>91.8%</b>		<b>Mixed Residue</b>	<b>0.0%</b>
Dirt, Sand, Soil	41.0%			
Concrete	42.6%			
Asphalt Paving	0.0%			
Brick, Ceramic, Porcelain	0.0%			
Rock, Gravel	8.1%			
RC Aggregates & Dirt	0.0%			
			<b>TOTAL</b>	<b>100.0%</b>

<sup>25</sup> Water Solutions and Kocks Ingenieure. (2018). *Feasibility Study for an Integrated Solid Waste Management System for Zone III and Preparation of Engineering Design of the Regional Waste Management Facility at Thilafushi.*

## 7. Forecasted demand

The long-term demand is captured using the same three gauges; the construction related imports, loans to construction industry, and the building permits issued. Historic data was obtained and analyzed to see long-term trends. Future projections were done based on historic data and the current situation of the Greater Male' region.

Statistics published by Maldives Monetary Authority shows rapid growth in construction-related imports over last five years<sup>25</sup> (Figure 3). However, a sudden decline in imports was observed in year 2009. This is because of the Global Financial Crisis in year 2009. Despite global recovery from the financial crisis, significant growth in years 2011 to 2012 was not observed because of the restrictions imposed by India on imports of aggregates. Prior to year 2009, construction industry had been experiencing rapid growth for five to six years. The growth in the construction industry since year 2013 is due to numerous public sector investment programme (PSIP) infrastructure projects, private sector investment in real-estate and expansion in tourism sector. As observed from Figure 3, consumption of construction materials is increasingly observed in private and tourism sector. This suggests the growth in resort development and residential property construction.

Loans to construction industry over recent years exhibit industry growth and support the trend observed from construction-related imports. Credit to tourism sector and construction industry has been increasing since second quarter of year 2015 (Figure 4). Growth in tourism sector is mainly due to lending for construction of guesthouses and new resort development. The growth in lending to the construction industry is due to lending for residential and housing purposes<sup>26</sup>.

---

<sup>26</sup> Maldives Monetary Authority. (2018). *Annual Report 2017*

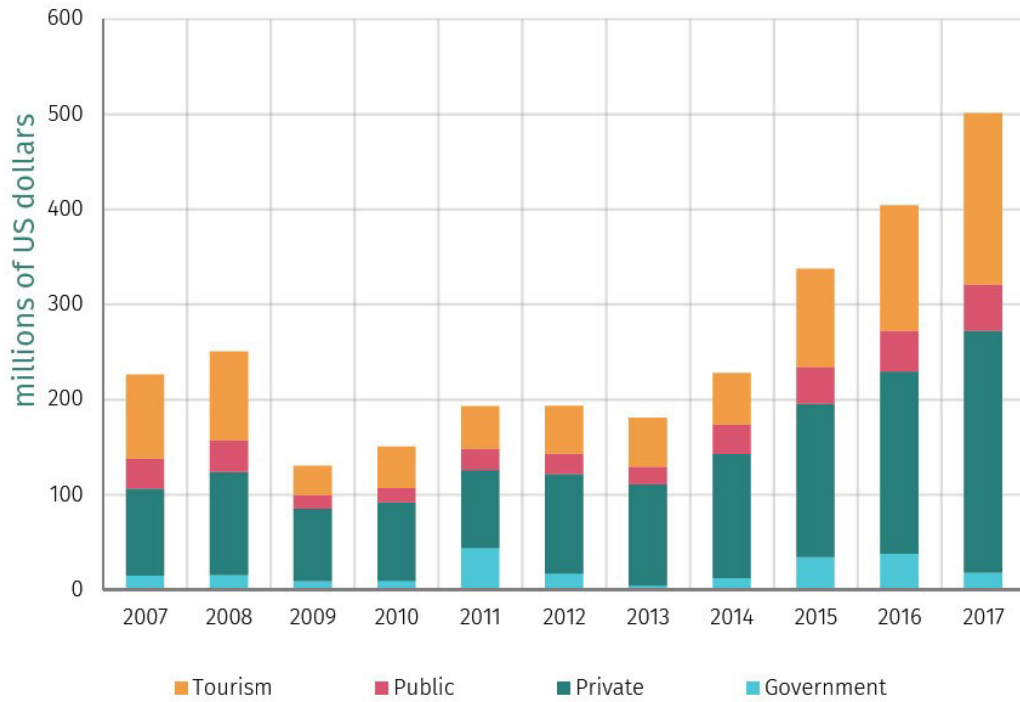


Figure 3. Construction related imports by sector<sup>27</sup>

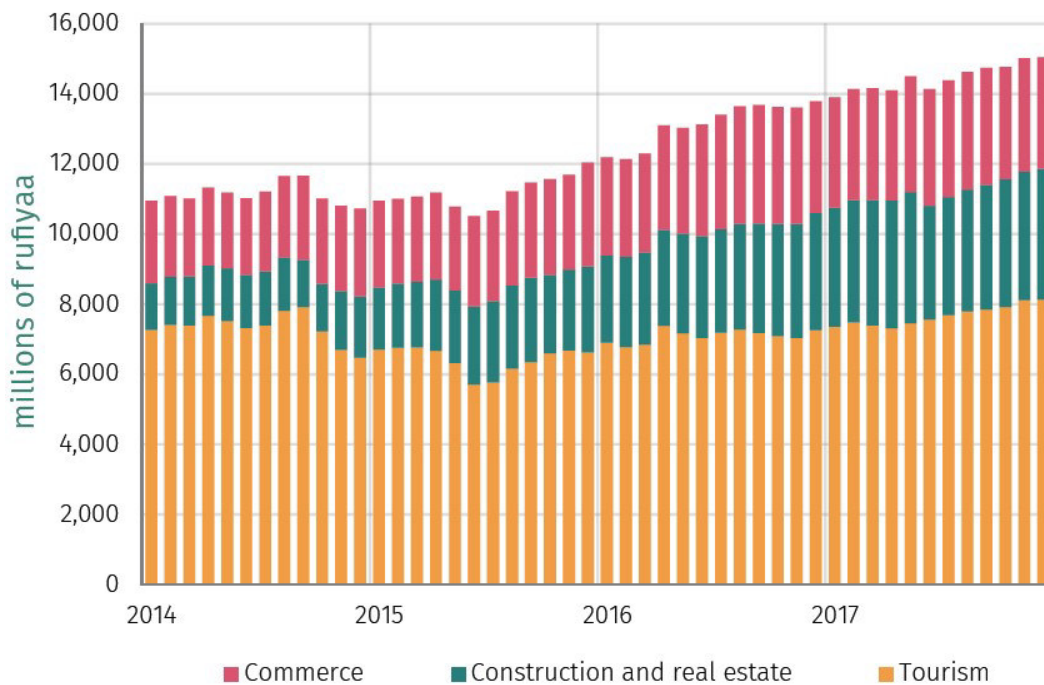


Figure 4. Loans and Advances to the Private Sector by Major Sectors<sup>27</sup>

<sup>27</sup> Maldives Monetary Authority. (2018). Annual Report 2017

Building permits is a key indicator of activity in construction industry. There are two types of permits; a permit given to commence construction and a permit given to use the building following completion of construction. Permits are well documented in Male' and Hulhumale'. Building permits available for the last fifteen years is collected and historic trends analyzed (Figure 5). Construction industry prior to year 2009 was a very robust industry with construction permits more than 500 permits annually. The industry was experiencing double digit growth rates<sup>28</sup>. However, the industry came to a halt in year 2009 due to the Global Financial Crisis and it is estimated to have contracted sharply by 16% in 2009 due to delays in major resort development projects owing to declines in capital inflows. Growth for the five years following year 2009 may have been affected by political instability and restrictions in availability of aggregates from India<sup>29</sup>. Since year 2013, with the increase in supply of aggregates, construction of residential buildings has been rapidly increasing and construction activity is similar to the trend observed before the financial crisis.

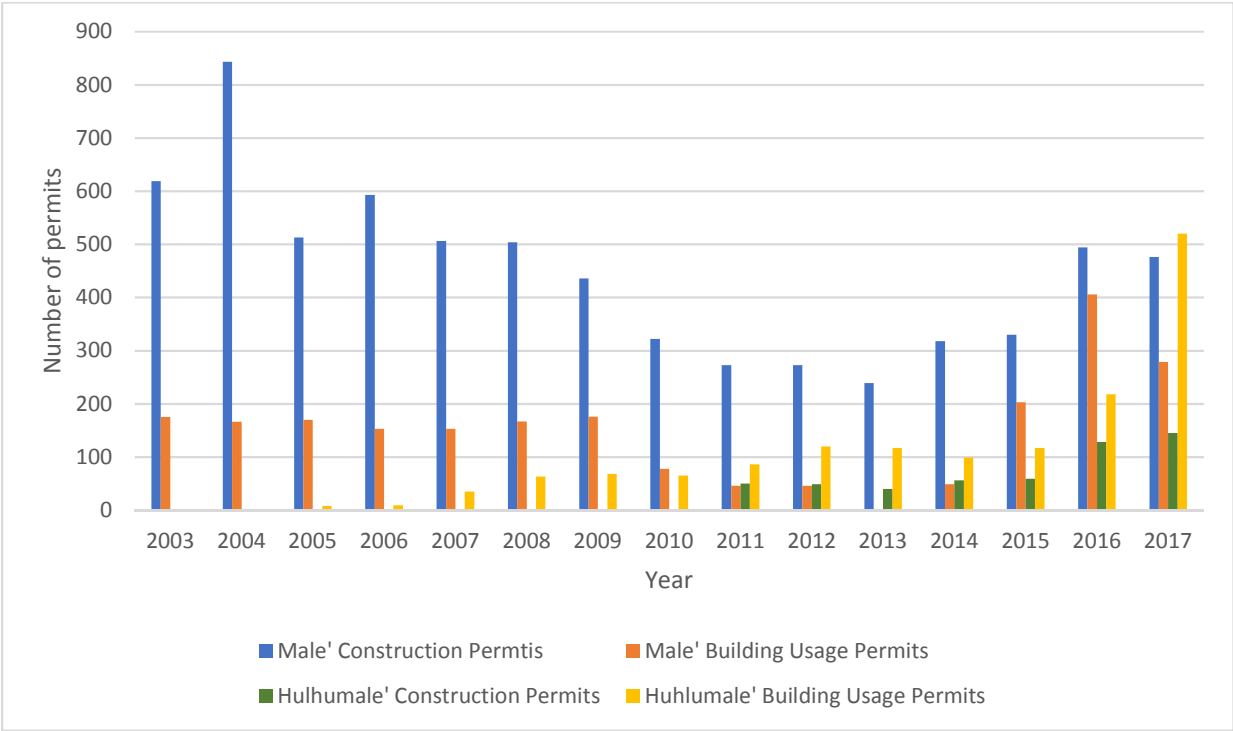


Figure 5. Building permits<sup>30</sup>

<sup>28</sup> Maldives Monetary Authority. (2010). *Annual Report 2009*.

<sup>29</sup> Maldives Monetary Authority. (2014). *Annual Report 2013*.

<sup>30</sup> National Bureau of Statistics, 2004 - 2017

Table 9. Imports of course aggregates and fine aggregates (sand)<sup>31</sup>

Year	Aggregates		Sand	
	Quantity (t)	CIF (MVR)	Quantity (t)	CIF (MVR)
2004	159,426	59,094,523	186,889	57,867,960
2005	191,518	76,128,976	245,979	86,542,799
2006	184,765	82,932,844	258,055	88,612,134
2007	355,762	186,032,748	432,665	200,161,633
2008	327,331	162,881,687	368,997	166,039,942
2009	184,180	86,776,242	165,230	63,140,895
2010	204,082	85,637,549	120,016	53,566,753
2011	267,540	136,810,147	153,877	88,147,309
2012	242,781	138,694,729	84,535	59,297,401
2013	180,492	147,359,782	133,699	105,190,451
2014	270,519	201,915,402	185,217	151,766,876
2015	536,523	344,320,685	226,981	155,857,347
2016	555,891	315,681,933	474,183	168,811,604
2017	803,326	425,625,230	330,156	177,082,708
2018	792,798	413,483,330	495,321	340,574,712

Historic data suggests that the construction industry has been a robust industry. The industry has potential growth due to the undeveloped reclaimed Gulhifalhu island and the recently reclaimed Hulhumale' phase 2. The relative annual growth rates of the last decade, (Figure 6) shows a positive growth. The exception is the year following Global Financial Crisis, where industry experienced a decline. The rate of growth is estimated by finding the average of the percentage growth of the three key indicators in years 2013 – 2017 (Table 10). Over the recent five years, the construction activity in Greater Male' Region has been restored close to the situation before the financial crisis. This is observed from the number of building permits in Figure 5. The average growth in construction related imports, credit to construction industry and construction permits is 22%, 26% and 17%, relatively. The average growth of these three key indicators is 22%.

<sup>31</sup> Maldives Customs Service (2018)

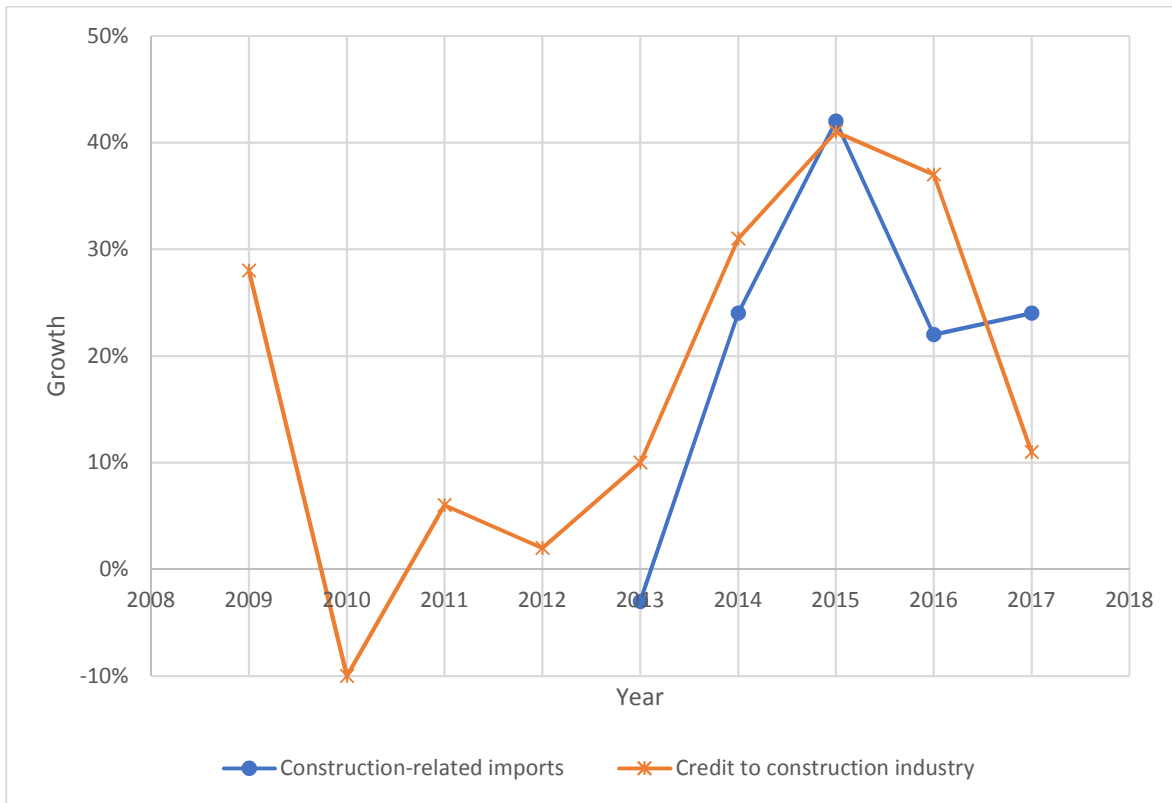


Figure 6. Growth of construction industry relative to preceding year

Table 10. Growth of key indicators of construction industry

Year	Construction-related imports	Credit to construction industry	Construction Permits	Building usage Permits
2017	24%	11%	0%	28%
2016	22%	37%	60%	95%
2015	42%	41%	4%	116%
2014	24%	31%	34%	26%
2013	-3%	10%	-13%	-30%
2012	-	2%	0%	26%
2011	-	6%	0%	-8%
2010	-	-10%	-26%	-41%
2009	-	28%	-13%	6%

Future total demand in aggregates were estimated based on historic import quantities. The data was obtained from Maldives Customs Services. Quantities of aggregates and sand (fine aggregates) imported to Maldives over last 15 years is shown in Figure 7. It is

believed the import quantity of sand obtained is only for river or natural sand and there might be quantities imported in various other names. The trend observed in aggregate imports mirrors the trend observed in the key indicators of the construction industry.



Figure 7. Imports of course aggregates and fine aggregates (sand) over 15 years <sup>32</sup>

Future demand projections are estimated based on historic values using exponential smoothing. Data since year 2011 is taken because Global Financial Crisis is an considered as an extreme and rare event and considering the two years following year 2009 would have affected the accuracy of the forecast. Figure 8 and Table 11 shows the demand forecast of aggregates in the industry for the next 15 years. Figure 9 and Table 12 shows the demand forecast of sand in the industry for the next 15 years. These are the total demand of the industry for aggregates and sand.

<sup>32</sup> Maldives Customs Service (2018)



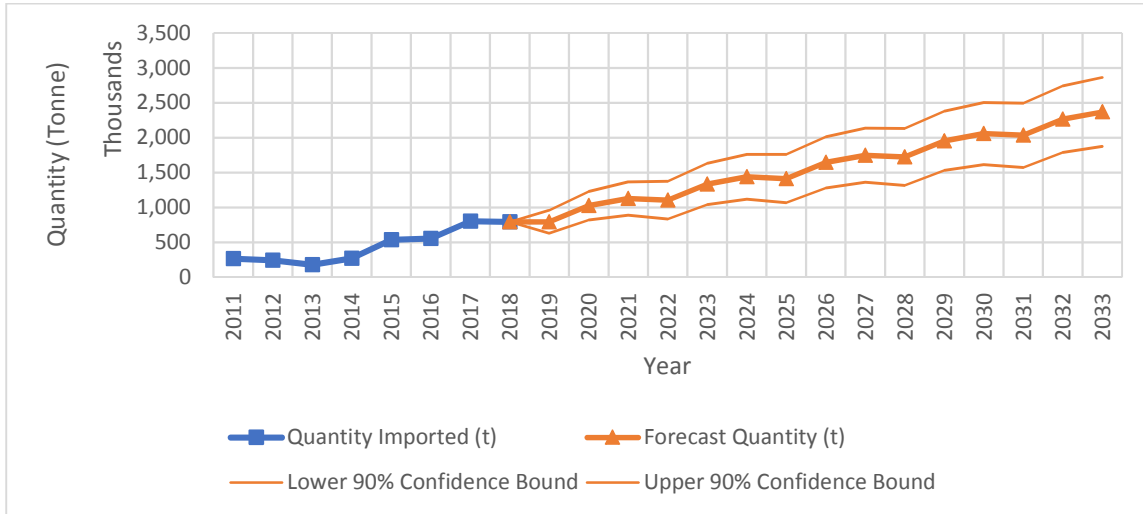


Figure 8. Forecast of course aggregates for 15 years (2018 - 2033)

Table 11. Forecast of course aggregates for 15 years (2018 - 2033)

Year	Quantity Imported (t)	Forecast Quantity (t)	Lower 90% Confidence Bound (t)	Upper 90% Confidence Bound (t)
2011	267,540			
2012	242,781			
2013	180,492			
2014	270,519			
2015	536,523			
2016	555,891			
2017	803,326			
2018	792,798	792,798	792,798	792,798
2019		794,590	630,542	958,638
2020		1,025,770	820,513	1,231,027
2021		1,128,784	889,223	1,368,346
2022		1,104,500	834,815	1,374,185
2023		1,335,679	1,038,913	1,632,446
2024		1,438,694	1,117,056	1,760,333
2025		1,414,410	1,069,571	1,759,249
2026		1,645,589	1,279,015	2,012,163
2027		1,748,604	1,361,461	2,135,747
2028		1,724,320	1,317,546	2,131,094
2029		1,955,499	1,529,999	2,380,999
2030		2,058,514	1,615,032	2,501,996
2031		2,034,230	1,573,378	2,495,082
2032		2,265,409	1,787,819	2,743,000
2033		2,368,424	1,874,620	2,862,227

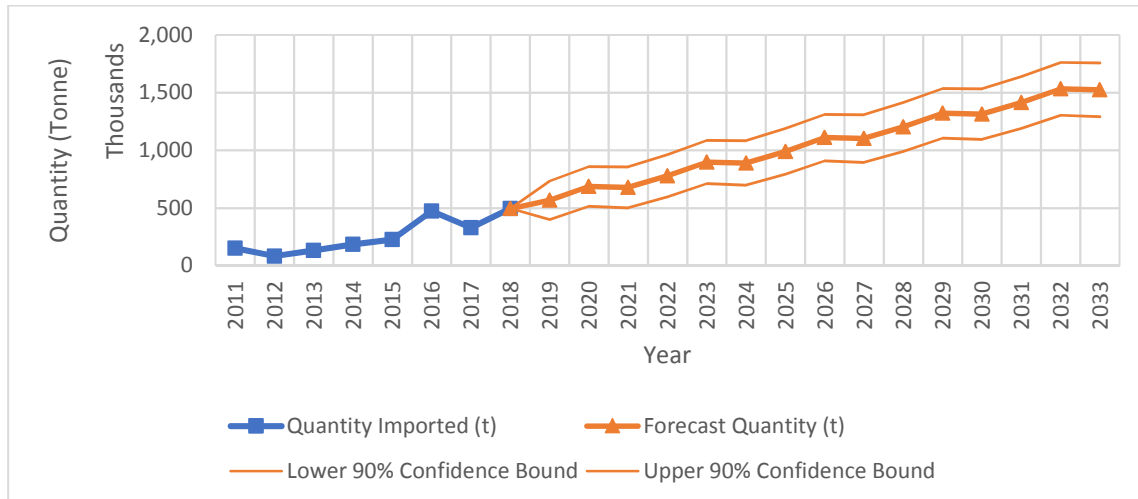


Figure 9. Forecast of fine aggregates (sand) for 15 years (2018 - 2033)

Table 12. Forecast of fine aggregates (sand) for 15 years (2018 - 2033)

Year	Quantity Imported (t)	Forecast Quantity (t)	Lower 90% Confidence Bound (t)	Upper 90% Confidence Bound (t)
2011	153,877			
2012	84,535			
2013	133,699			
2014	185,217			
2015	226,981			
2016	474,183			
2017	330,156			
2018	495,321	495,321	495,321	495,321
2019		568,631	401,394	735,869
2020		688,224	515,758	860,690
2021		680,146	502,565	857,726
2022		779,772	597,143	962,401
2023		899,364	711,822	1,086,906
2024		891,286	698,919	1,083,653
2025		990,912	793,766	1,188,059
2026		1,110,505	908,692	1,312,317
2027		1,102,427	896,018	1,308,835
2028		1,202,053	991,080	1,413,026
2029		1,321,645	1,106,204	1,537,086
2030		1,313,567	1,093,715	1,533,419
2031		1,413,193	1,188,952	1,637,434
2032		1,532,786	1,304,240	1,761,332
2033		1,524,708	1,291,904	1,757,511

There is no historic data available to use exponential smoothing to forecast the sand required for concrete masonry block making. The current demand is approximately 291 tpd of sand for block production in Male' and Hulhumale'. The demand of sand required for concrete masonry block making in the next 15 years is forecasted by assuming a linear growth equal to the estimated industry growth rate of 22%. However, computing growth at a rate of 22% for 15 years result in an exponential growth and is not realistic. Hence, linear growth at 22% is only computed for five years and used as historical values to use exponential smoothing to forecast for the next 10 years. The forecasted demand is shown in Figure 10 and the quantities are given in Table 13. The projected quantity of IBA and recyclable CDW is estimated in the feasibility study (Table 14). The projected IBA and recyclable CDW quantities are compared with the forecasted demand of sand required in block production (Figure 11). The quantity of CDW aggregates is initially more than the forecasted demand of sand used in block production. However, since year 2021, the demand of sand, including the lower bound, is more than the total IBA and CDW recyclables generated.

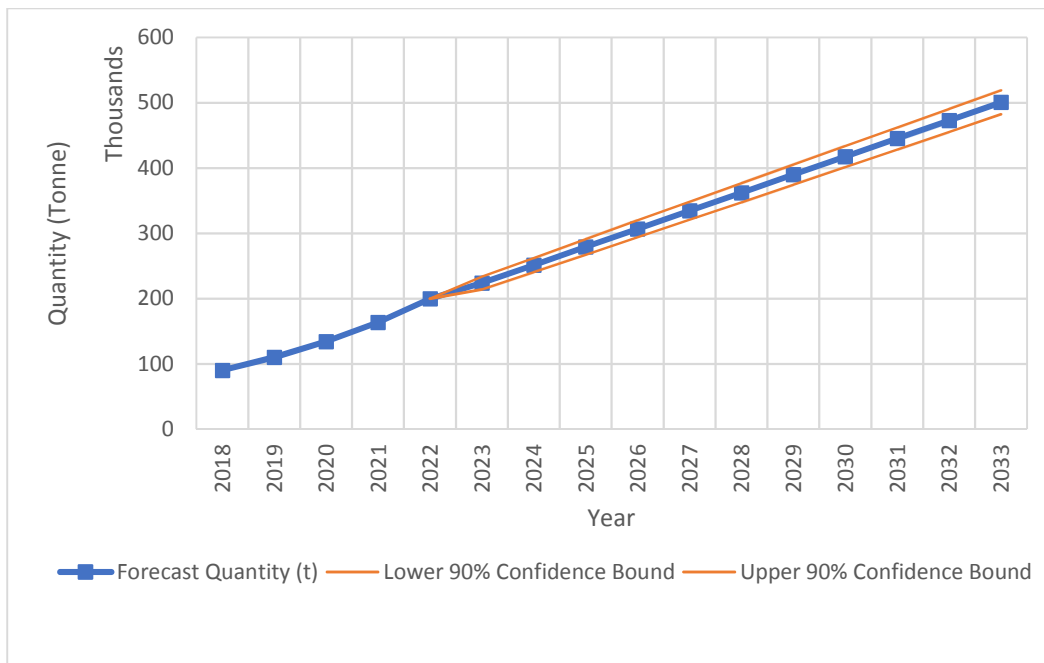


Figure 10. Demand forecast of fine aggregates (sand) required in concrete masonry block production for 15 years (2018 – 2033)

Table 13. Demand forecast of fine aggregates (sand) required in concrete masonry block production for 15 years (2018 – 2033)

Year	Forecast Quantity (t)	Lower 90% Confidence Bound (t)	Upper 90% Confidence Bound (t)
2018	90,210		
2019	110,056		
2020	134,269		
2021	163,808		
2022	199,845	199,845	199,845
2023	223,809	214,076	233,542
2024	251,494	240,607	262,380
2025	279,178	267,246	291,110
2026	306,862	293,965	319,760
2027	334,547	320,748	348,346
2028	362,231	347,583	376,880
2029	389,916	374,462	405,370
2030	417,600	401,377	433,823
2031	445,285	428,325	462,244
2032	472,969	455,301	490,637
2033	500,653	482,301	519,006

Table 14. Projection of IBA and CDW aggregates generation (Feasibility Study, 2017)

Year	Recyclables of CDW	IBA generated
2018	151572	
2019	153664	
2020	155787	
2021	157944	
2022	160134	
2023	162358	43125
2024	164617	43125
2025	166911	43125
2026	169242	43125
2027	171608	43125
2028	174012	43125
2029	176454	43125
2030	178934	43125
2031	181453	43125
2032	184012	43125
2033	186611	43125

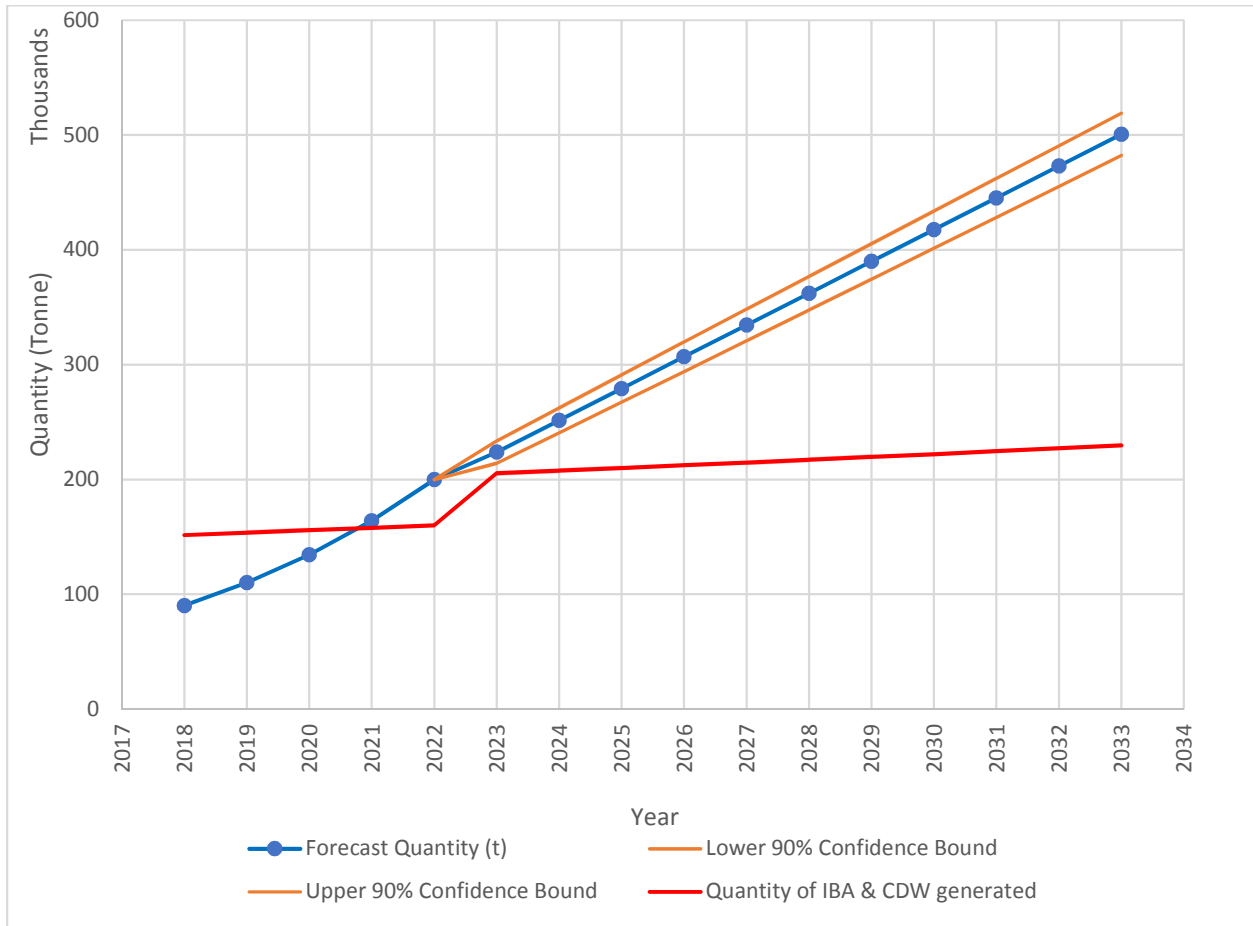


Figure 11. Comparison of forecasted sand required for concrete block production against IBA and CDW generated

A sensitivity analysis was done to evaluate consumption of IBA and CDW in various market share scenarios. The Figure 11 represents IBA and CDW consumptions when 100% market penetration is adopted. Three alternative scenarios were considered; 90%, 80% and 60% of the market share (Figure 12 and Table 15), instead of the 100% market share represented in Figure 11. When 100% market penetration is possible, all the IBA and CDW generated can be consumed by the block production industry. However, when market share reduces to 90% of the forecasted demand, not all IBA and CDW that is generated is consumed in year 2023. Similarly, when market share reduces to 80% of the forecasted demand, there are some IBA and CDW left over in years 2023 and 2024. When the market share reduces to 60% of the forecasted demand, there are some IBA and CDW left over in years 2023 to 2028. The left over IBA and CDW could be used for

other purposes like screeds as suggested by the participants interviewed. It is recommended to try to achieve 100% market share. This can be achieved easily by drastically reducing the price of IBA and CDW. IBA and CDW are substitute products to natural aggregates and price is the driving factor that drives demand in substitute products.

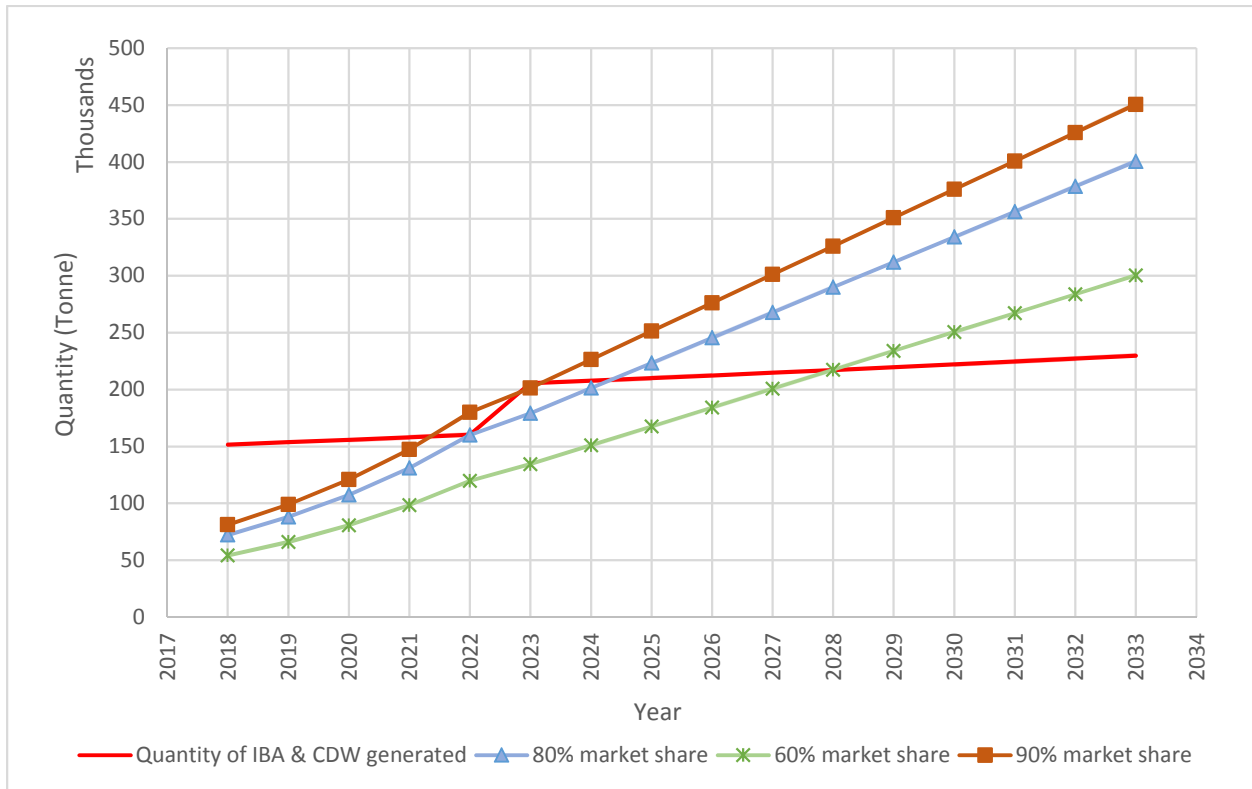


Figure 12. Sensitivity analysis of demand for IBA and CDW in concrete masonry block production

Table 15. Sensitivity analysis of demand for IBA and CDW in concrete masonry block production

Year	90% market share				80% market share				60% market share			
	20% IBA (t)	Unused IBA (t)	80% CDW (t)	Unused CDW (t)	20% IBA (t)	Unused IBA (t)	80% CDW (t)	Unused CDW (t)	20% IBA (t)	Unused IBA (t)	80% CDW (t)	Unused CDW (t)
2018			81,189	70,383			72,168	79,404			54,126	97,446
2019			99,051	54,613			88,045	65,619			66,034	87,630
2020			120,842	34,945			107,415	48,372			80,561	75,226
2021			147,427	10,517			131,046	26,898			98,285	59,659
2022			179,861	0			159,876	258			119,907	40,227
2023	40,286	2,839	161,143	1,215	35,809	7,316	143,238	19,120	26,857	16,268	107,428	54,930
2024	45,269	0	181,075	0	40,239	2,886	160,956	3,661	30,179	12,946	120,717	43,900
2025	50,252	0	201,008	0	44,668	0	178,674	0	33,501	9,624	134,005	32,906
2026	55,235	0	220,941	0	49,098	0	196,392	0	36,823	6,302	147,294	21,948
2027	60,218	0	240,874	0	53,527	0	214,110	0	40,146	2,979	160,582	11,026
2028	65,202	0	260,807	0	57,957	0	231,828	0	43,468	0	173,871	141
2029	70,185	0	280,739	0	62,387	0	249,546	0	46,790	0	187,160	0
2030	75,168	0	300,672	0	66,816	0	267,264	0	50,112	0	200,448	0
2031	80,151	0	320,605	0	71,246	0	284,982	0	53,434	0	213,737	0
2032	85,134	0	340,538	0	75,675	0	302,700	0	56,756	0	227,025	0
2033	90,118	0	360,470	0	80,105	0	320,418	0	60,078	0	240,314	0

## 8. Sustainable Business Model

The reuse of IBA and CDW as an exported alternative raw material in cement manufacturing, in structural concrete, as a fill material for road bases and sub-base layers, and fill material for land reclamation can be technically feasible as suggested by literature review. However, the financial feasibility or technical uncertainties in the Maldives context limits the reuse of IBA and CDW in many applications that might be viable in other countries.

Considering the logistics involved, the quantity of IBA available for exporting to a cement manufacturer is too small to achieve economies of scale. Similarly, uncertainties in the characteristics of CDW and low performance of IBA replaced concrete limits the reuse of IBA and CDW in structural concrete. The reuse of IBA in road construction is practiced widely in Europe and IBA is used for land reclamation in Japan port areas. However, due to the intermittent frequency and the large volumes of materials required for road and reclamation projects, the reuse of IBA or CDW is not viable for such projects in Maldives.

Concrete masonry block making is an application that has potential for the reuse of IBA and CDW aggregates in Maldives. Based on literature review, the replacement of sand with IBA is technically feasible. The performance of the blocks with r-IBA meets the required standards. Moreover, the demand forecast of sand required in 2023, the planned year to commence incineration of waste, is greater than the amount of IBA generated. Hence, all the IBA produced can be utilized. Similarly, it is recommended to crush CDW to sand size particles and reuse it for masonry block making. The forecasted demand of sand required for block production and the CDW aggregates generated become equal in year 2020, and then the demand is higher than supplied by CDW aggregates. Hence, all the CDW produced can be utilized in the block making industry, assuming 10% market penetration.

There are two business options. The first option is the CDW processing plant operator adopting forward integration and become either a supplier of IBA and CDW aggregates as raw materials to the market or starting a block production business. The consultant



does not recommend the first option because the amount of IBA and CDW aggregates generated is much less than the market demand. To create a demand for the product, the operator should ensure reliability of the availability of the product in quantities demanded by the market. This concern was raised by one of the large contractors interviewed. The contractor noted he would be willing to purchase IBA and CDW at a lower cost for his block production if a continuous stream of raw materials is ensured. The contractor highlighted that IBA and CDW depends on the availability of waste, which can be variable, and hence questioned the reliability of the availability. Furthermore, IBA and CDW would probably be used to replace part of the natural sand used. Hence, contractors or block producers would like to get all the required sand from one place. In such cases, the operator might be required to get into the business of importing sand.

The second option is to use an intermediately aggregate supplier like State Trading Organization (STO) instead of directly selling it to the market. This option is more recommendable because it eliminates the risks and costs associated with trading with the market directly. STO is one of the major aggregates supplier and has established customer bases and distribution networks. Hence, adopting the second option is financially more attractive.

Table 16 shows the price comparison of different types of sand used for block production. The price of IBA and CDW aggregates are the prices suggested by the consultant in the feasibility study. As observed the unit price of IBA and CDW aggregates are significantly cheaper. Since the materials are substitute goods, a drastic reduction in price would increase the demand for the IBA and CDW aggregates, provided the performance is assured.

*Table 16. Price comparison of sand used for concrete masonry block production and IBA and CDW*

	<b>Price (MRV/Mg)</b>	<b>Price (USD/Mg)</b>
Sand (fine aggregates)	794.18	51.5
Local sand	225	14.59
IBA	77.1	1 – 5
CDW aggregates	33.55	1 – 2.18

## 9. Recommendations

Concrete masonry block and pavement block production is a potential application for utilization of IBA and CDW in Maldives. Use of IBA and CDW in non-structural applications such as use in floor screed concrete could be a potential market too.

The demand forecast shows the generation of IBA and CDW could be less than the demand required by the block production industry, provided 100% market penetration is possible. It is recommended that Government should promote the use of IBA and CDW through campaigns to assure the technical and safety suitability of the waste products.

The general response of stakeholders consulted is promising and many are willing to accept the product if the price is significantly lower than natural aggregates and the performance of the product meets the standards, often international standards.

There are no existing local standards directly related to IBA or CDW, mainly because these are new products in the Maldivian market. However, new regulations governing the reuse of IBA and CDW should be expected soon as Ministry of Environment is in the process of formulating environmental regulations to IBA and CDW. Hence, it is suggested that treating of IBA and CDW is critical to ensure the characteristics and performance confirms to international best practices and consequently the acceptance of r-IBA and processed CDW as a building material in Maldives.

It is recommended to introduce the products to the market through intermediately aggregates supplier. Additionally, the price should be significantly lower than natural aggregates to drive the demand for IBA and CDW.

## 10. References

- Brito, J. d., & Saikia, N. (2013). *Recycled Aggregate: Use of Industrial, Construction and Demolition Waste*. London: Springer.
- Guo, L., & Wu, D. -Q. (2018). Study of leaching scenarios for the application of incineration bottom ash and marine clay for land reclamation. *Sustainable Environment Research*, 396-402.
- Guo, L., & Wu, D.-Q. (2017). Study of recycling Singapore solid waste as land reclamation filling material. *Sustainable Environment Research*, 1-6.
- Lam, C. H., Ip, A. W., Barford, J. P., & McKay, G. (2010). Use of Incineration MSW Ash: A Review. *Sustainability*, 1943-1968.
- Liu, A., Lin, W. Y., & Wang, J. Y. (2015). A review of municipal solid waste environmental standards with a focus on incinerator residues. *International Journal of Sustainable Built Environment*, 165–188.
- Lynn, C. J., Ghataora, G. S., & Dhir, R. K. (2017). Municipal incinerated bottom ash (MIBA) characteristics and potential for use in road pavements. *International Journal of Pavement Research and Technology*, 185-201.
- Lynn, C. J., Ghataora, G. S., & Dhir, R. K. (2018). Environmental impacts of MIBA in geotechnics and road applications. *Environmental Geotechnics*, 31-55.
- Lynn, C., Dhir, R., & Ghataora, G. (2016). Municipal incinerated bottom ash characteristics and potential for use as aggregate in concrete. *Construction and Building Materials*, 504-517.
- Maldives Monetary Authority . (2014). *Annual Report 2013*.
- Maldives Monetary Authority. (2010). *Annual Report 2009*.
- Maldives Monetary Authority. (2018). *Annual Report 2017*.
- Neville, A. M., & Brooks, J. J. (2010). *Concrete Technology*. Harlow: Pearson Education Limited.
- Nguyen, L. C., Inui, T., Ikeda, K., & Katsumi, T. (2015). Aging effects on the mechanical property of waste mixture in coastal landfill sites. *Soils and Foundations*, 1441-1453.
- Pan, J. R., Huang, C., Kuo, J.-J., & Lin, S.-H. (2008). Recycling MSWI bottom and fly ash as raw materials for Portland cement. *Waste Management*, 1113-1118.
- Singh, D., & Kumar, A. (2017). Geo-environmental application of municipal solid waste incinerator ash stabilized with cement. *Journal of Rock Mechanics and Geotechnical Engineering*, 370-375.
- Tang, Q., Gu, F., Chen, H., Lu, C., & Zhang, Y. (2018). Mechanical Evaluation of Bottom Ash from Municipal Solid Waste Incineration Used in Roadbase. *Advances in Civil Engineering*.
- Water Solutions and Kocks Ingenieure. (2018). *Feasibility Study for an Integrated Solid Waste Management System for Zone III and Preparation of Engineering Design of the Regional Waste Management Facility at Thilafushi*.

## Fly Ash Management Plan (Handling of Air Pollution Control Residues) Greater Male Waste-to-Energy Project

### 1 Generation of Air Pollution Control Residues

As per Employer's Requirements (ERQ) of the envisaged DBO Contract, the Air Pollution Control (APC) system shall consist of a semi-dry or dry system that will generate hazardous residues containing the acid and organic flue gas components and heavy metals in a soluble form which require careful handling. The volume of APC residues depends on the type of absorbent used to clean the flue gases. According to a preliminary mass balance prepared during the feasibility study around 50 kg APC residues per tonne of waste will be generated. In total, approx. 8,500 tonnes are expected to be generated every year if the facility runs at full capacity. According to the European BAT Reference Document for Waste Incineration (BREF) Document that is to be applied, APC residues including the fly ash that is retained by the APC system must not be commingled with the boiler ash and the bottom ash.

APC residues are regarded in all countries that are incinerating waste as hazardous due to their heavy metal content in an easily leachable form. Subject to the absorbent and, of course, the type of waste incinerated, the composition of the APC residues may be characterised as listed in Table 1 (heavy metals highlighted in dark grey).

Table 1: Components of the residues of a semidry/dry APC system<sup>1</sup>

Element	Content in mg/kg
Ca	110,000 – 350,000
K	5,900 – 40,000
Mg	5,000 – 14,000
Na	7,600 – 29,000
Si	36,000 – 120,000
Cl	62,000 – 380,000
S	1,400 – 25,000
Al	12,000 – 83,000
Fe	2,600 – 71,000
As	18 – 530
Ba	51 – 14,000
Cd	140 – 300
Cr	73 - 570
Cu	16 – 1,700
Hg	0.1 – 51
Mn	200 – 900
Mo	9 – 29
Ni	19 – 710
Pb	2,500 – 10,000
Sb	300 – 1,100
V	8 – 62

<sup>1</sup> according to Chandler, Eighmy, Hartlém, Hjelmar, Kosson, Sawell, von der Sloot, Vehlow: Municipal solid waste incinerator residues (1997), cited in Management of APC residues from WtE Plants, ISWA 2008

Zn	7,000 – 20,000
----	----------------

Besides the combustion conditions in the furnace (2 sec, 850°C), the homogeneity of the conditions across the furnace cross section and a sufficient turbulence in the post combustion chamber is an important parameter to control the dioxin and furan contents of the APC residues. Measurements in UK from 2004 revealed concentration between 800 and 1,750 ng TEQ/kg while eluates did not show a significant level above background contamination which was between 0.4 and 2 pg/l<sup>2</sup>.

## 2 Envisaged APC residue treatment and other nations current disposal practices

Because no worldwide methodology or guideline on how to deal with APC residues in an environmentally sound and technically feasible manner has been established, most nations do follow their own approach which again is subject to the local conditions such as availability of disposal sites, national legislation and the costs of the APC residue treatment.

In Germany, APC residues from dry/semi-dry system are usually stored in old salt mines as backfilling material (only if water ingress can be ruled out). Facilities in France with bicarbonate as absorbent apply an extraction of heavy metals at pH 9 and thus try to reuse the bicarbonate (which yet contains chloride) from the so obtained brine. As disposal option for the heavy metals, hazardous waste landfills are used. Dutch facility uses big bags with inlet liners and douses the APC residues during unloading with water to trigger pozzolanic reactions. By this, the APC residues solidify while the inlet liners of the big bags prevent water seepage into the big bags.

In the USA, APC residues are stored mostly in hazardous waste landfills. Some facilities use the bottom ash to stabilise the APC residues (due to pozzolanic effect of bottom ash after dousing with water).

Some Japanese facilities (appr. 30) vitrify both the bottom ash and APC residues, thus obtaining a highly concentrated and salt-rich residue (which is difficult to handle though). Costs for this kind of treatment are significant and can be as high as \$500/tonne of residue.

Deliberately, a stabilisation/solidification of the APC residues or any other treatment method was not explicitly prescribed to allow the DBO Contractor to develop a solution that meets the local requirements. Adding cement, for example, can, subject to the absorbent used in the APC system, triple the amount of residues to be landfilled which may be a costly undertaking in the Maldives. Hence, other pozzolanic reaction inducing additives have to be selected if the Contractor opts for such a solution. Space requirements for storing the stabilised bricks while they undergo the transformation was another factor which cannot be ignored. A plant to process around 25 tonnes per day requires 40mx20m, most of the space for storage to allow the bricks to solidify – up to 8 weeks.

---

<sup>2</sup> Testing of residues from incineration of municipal solid waste, UK Environment Agency, 2004

Whether and to what extent, the DBO Contractor will use the residues after the bottom ash treatment to trigger a pozzolanic reactions, shall be left to the sole discretion of the Contractor which is in line with the general principles of a DBO contract to stimulate the competition of the bidders to present the technically most robust but an economically attractive solution.

Because the Maldives do not have a comprehensive environmental regulatory framework yet, the European standards that according to the BREF Document do require a separate handling of the bottom ash and the APC residues are regarded as the best option to maximise the reuse of the bottom ash and to concentrate the toxic substances within the smallest volume of residues, i.e. the APC residues. Since the BREF Document does not define the landfilling and the treatment of the APC residues and a DBO Contractor may have a preference for the one or other treatment option, it shall be left to the DBO Contractor to develop the solution against the standards that are defined in the ERQ.

During the design review, the Contractor has to provide the full documentation of for the APC residue handling. In the event it does not meet good international industrial practice or does not achieve the desired design standards, the Employer has any right to request modification.

### 3 Design Build Requirements as per ERQ

To avoid any impact to the environment and to the Contractor's personnel safety, the Contractor's design shall consider the following for conveying and loading APC residues:

- APC residues shall not be mixed with bottom or boiler ash prior to the bottom ash treatment.
- APC residues shall be conveyed in closed conveying systems that end up in storage silos whose exhaust air can be dedusted via a central dedusting system.
- The top of the bag filter housing shall be enclosed and shall be connected to the central dedusting system (while pulling/replacing bag-filter hoses).
- Discharging the APC residues from the silos into water-tight jumbo bags (with inlet) or into the transfer vehicles shall be carried out via dust-tight discharging chutes.
- APC residues shall be treated by either stabilization/solidification or via triggered pozzolanic reaction prior to landfilling to limit the leachability of heavy metals.

The ERQ request the Contractor to design and construct the landfill for the APC residues according to the European Landfill Directive 1999/31/EC and its latest amendment 2018/850/EC. The design of the landfill – i.e. whether a single compartment or different compartments for the APC residues and the remaining bottom ash – shall be subject to the design considerations of the Contractor. In any case, the Contractor shall take account of the following:

- The barrier system shall encompass an artificially completed/reinforced geological barrier (thickness shall be not less than 0.5 m) that can offer an equivalent protection as defined in the European Landfill Directive 1999/31/EC for hazardous wastes. An impermeable artificial liner for at least the compartment that is designated for the APC residues shall be provided. Given that Maldivian soils do not offer a geological barrier having a hydraulic conductivity of less than  $10^{-9}$  m/s and a thickness of more

than 5 m, the artificial geological barrier is the only way to apply to multi-barrier system.

- The compartment, if any, for the residues from the bottom ash processing shall be provided with an artificially completed geological barrier. Its thickness shall not be less than 0.5 m and shall meet the hydraulic resistance requirements for non-hazardous waste as stipulated in the European Landfill Directive.
- The barrier system shall be designed to allow minimizing the leachate generation by dividing the compartments into cells that will accommodate waste subsequently according to the filling plan of the landfill.
- The lower level of the engineered barrier shall be no deeper than 1.5 meters above mean sea level and in accordance with the applicable environmental standards;
- Prior to construction, the Contractor shall prepare a test pad to demonstrate the effectiveness of the proposed engineered barrier.
- In the design of the Contractor, a composite cover system shall be included (see also operational requirements).

For the leachate management, the Contractor shall take into consideration the following:

- The design shall warrant a minimized leachate generation applying means, such as, but not limited to, constructing a shed above the hazardous waste compartment, separating not contaminated water from leachate by installing gate valves, constructing bunds to control the leachate flows, etc.
- The design of the Contractor shall take account of that leachate from different compartments for APC residues and residues from the bottom ash processing are collected and treated so that the leachate discharge standards are met any time. Applying strictest discharge standards is the only way to control the APC residue disposal in the Maldives case.
- The Contractor shall design and build or organize a system for the safe collection, transport and disposal of the LTP concentrate.
- Subject to its design, the Contractor shall re-inject the concentrate after the leachate treatment in the air pollution control system or shall evaporate it. In the latter case, the residues shall be disposed on the landfill so that no accumulation of the highly soluble material is to be concerned.
- Monitoring wells to detect any potentially escaping leachate shall be installed.

## 4 Requirements during Operation Service Period

Focusing on the APC residues, during landfilling the Contractor shall consider:

- APC revenues shall be disposed safely to landfill meeting the European standards (1999/31/EC) as defined for hazardous waste. Safe disposal means that APC residues shall be unloaded either into water-tight jumbo bags in a semi-solid state (after dousing with water) or shall be stabilized/solidified. Given that APC residues are the only type of hazardous waste, no acceptance tests are needed.
- The Contractor shall dispose of all APC residues and any other residual wastes (i.e. excluding bottom ash for recycling and valuable wastes to be exported for reuse) to the dedicated landfill cells located within the Site, in accordance with the approved

Residual Waste Plan which requests the Contractor to assign the landfill areas for the disposal of the APC residues.

- The method of APC residue disposal shall be as detailed in the Contractor's approved Operation and Maintenance Plan and the Contractor's approved Annual Residual Waste Plan. The Contractor shall arrange all APC disposal as necessary to achieve the most efficient use of the available landfill volume.
- The Contractor shall minimize the generation of leachate by applying control measures including, but not limited to, closing gate valves where appropriate, covering landfill areas that are not needed as working face with impermeable liners, preparing an optimized Residual Waste Plan.
- During the Operation Service Period, the Contractor shall prepare a closure plan that shall include the following:
  - A stability calculation of the envisaged final shape of the landfill body demonstrating its stability considering appropriate friction and slippage coefficients of the materials landfilled and the cover layers applied.
  - A contour layer to smoothen the final shape of the landfill body.
  - A complementary dual cover system for the hazardous APC residues so that in the event one layer fails the other layer can withstand the ingress of water. In the event a mineral layer is applied, the layer shall provide a calculated percolation rate similar to a mineral layer of at least 0.5 m thickness having a permeability coefficient of not greater than  $5 \times 10^{-10}$  m/s at a constant water head of 0.3 m. If a geomembrane is used, its thickness shall be not less than 2.0 mm.
  - A leakage control system shall be applied for the dual cover system.
  - A sufficiently dimensioned drainage layer (thickness  $\geq 0.3$  m, permeability coefficient  $> 5 \times 10^{-3}$  m/s).
  - A recultivation layer incl. a natural vegetal cover (thickness  $> 0.5$  m) that meets the local conditions
- The leakage control system shall be operated after closure of the landfill (sub)cells. Samples shall be taken every quarter and fingerprint analyses shall be carried out.
- Samples from the monitoring wells shall be analyzed regularly (at least once per quarter) for parameters such as PAHs, phenols, cadmium, chromium (hexavalent and total), copper, iron, lead, mercury, nickel, zinc.

Requirements towards the APC residues handling and the components necessary to retain APC residues include:

- The Contractor shall handle and dispose of all APC residues and ensure that processing is conducted in a manner that prevents fugitive emissions and escape of dust.
- Bag filter hoses shall be replaced only if the central dedusting system is operational.
- Unloading the silos shall be carried out using dust-tight unloading chutes only.
- The area around the APC residues silo shall be kept clean at all times and spills shall be dealt with immediately.
- The driver of the APC residues transport vehicle shall be required to use personal protective equipment during loading and unloading to prevent the inhalation of dust and fumes.





Environmental and Social Impact Assessment for the Regional Solid Waste Management Facility (RSWMF) Thilafushi

## Marine Survey Report



Thilhafushi house reef. Photo by: Water Solutions

**Prepared by:** Abdul Aleem (EIA P03/2019), Mohamed Umar (EIA P02/2019) & Abdulla Fazeel



23<sup>rd</sup> September 2019

---

## Contents

1	Introduction.....	4
2	Scope of work.....	4
3	Methodology.....	4
3.1	Benthic Survey .....	7
3.1.1	Surveys in April 2018 .....	7
3.1.2	Reef profile Survey in September 2019 .....	7
3.1.3	Manta Tow survey in September 2019 .....	7
4	Data Processing methodology.....	7
5	Results of the marine survey.....	9
5.1	Status of site 1 (M1) .....	9
5.2	Status of site 2 (M2) .....	10
5.3	Status of site 3 (M3) .....	11
5.4	Status of site 4 (M4) .....	12
5.5	Status of site 5 (M5) .....	13
5.6	Status of site 6 (M6) .....	14
5.7	Status of site 7 (M7) .....	15
5.8	Observation during the marine survey in 2019.....	16
5.9	Status of site M8.....	17
5.10	Status of site M9 .....	18
5.11	Status of site M10 .....	19
5.12	Manta Tow between M9 and M10.....	20
5.12.1	Protected marine species .....	20
5.12.2	Reef Aesthetics .....	20
5.13	Fish Diversity and Abundance (April 2018).....	20
5.14	Fish Diversity and Abundance (September 2019) .....	23
5.14.1	Plankton tows.....	24
6	Conclusion .....	28

---

## List of Figure

Figure 1: Marine surveyed locations with coordinates in 23 <sup>rd</sup> – 24 <sup>th</sup> April 2018 and 1 <sup>st</sup> September 2019 .....	5
Figure 2: Marine surveyed locations with coordinates in 23 <sup>rd</sup> – 24 <sup>th</sup> April 2018 and 1 <sup>st</sup> September 2019 .....	5
Figure 3: Marine surveyed locations on 1 <sup>st</sup> September 2019 .....	6
Figure 4: Plankton tows and water sampled location on 23 <sup>rd</sup> – 24 <sup>th</sup> April 2018 .....	6
Figure 18: Percentage benthic composition at site 1(M1) at depths of 5 and 10 meters $\pm$ Standard Error (SE) (23 <sup>rd</sup> April 2018). .....	9
Figure 19: Photos taken from site 1 at depths of 5 and 10 meters (M1) (23 <sup>rd</sup> April 2018). .....	9
Figure 20: Percentage benthic composition at site 2 (M2) $\pm$ SE (24 <sup>th</sup> April 2018). .....	10
Figure 21: Photos taken from site 2 (M2) (24 <sup>th</sup> April 2018). .....	10
Figure 22: Percentage benthic composition at site 3 (M3) $\pm$ SE (23 <sup>rd</sup> April 2018). .....	11
Figure 23: Photos taken from site 3 (M3) (23 <sup>rd</sup> April 2018). .....	11
Figure 24: Percentage benthic composition at site 4 (M4) $\pm$ SE (24 <sup>th</sup> April 2018). .....	12
Figure 25: Photos taken from site 4 (M4) (24 <sup>th</sup> April 2018). .....	12
Figure 26: Percentage benthic composition at site 5 (M5) $\pm$ SE (24 <sup>th</sup> April 2018). .....	13
Figure 27: Photos taken from site 5 (M5) (24 <sup>th</sup> April 2018). .....	13
Figure 28: Percentage benthic composition at site 6 (M6) $\pm$ SE (24 <sup>th</sup> April 2018). .....	14
Figure 29: Photos taken from site 6 (M6) (24 <sup>th</sup> April 2018). .....	14
Figure 30: Percentage benthic composition at site 7 (M7) $\pm$ SE (23 <sup>rd</sup> April 2018). .....	15
Figure 31: Photos taken from site 7 (M7) (23 <sup>rd</sup> April 2018). .....	15
Figure 32: Percentage benthic composition at site 2(M2) at a depth of 10 meter $\pm$ standard error (SE). .....	16
Figure 33: Photos compiled from site 2 (M2) at a depth of 10 meters. ....	16
Figure 6: Reef slope characteristics at M8 (1st September 2019). .....	17
Figure 7: Percentage benthic composition at site M8 at depths from ~ 3 to 30 meters $\pm$ Standard Error (SE) (1 <sup>st</sup> September 2019). .....	17
Figure 8: Percentage benthic composition at site M9 at depths from ~ 3 to 30 meters $\pm$ SE (1 September 2019). .....	18
Figure 9: Reef slope characteristics at M9 (1 September 2019). .....	18
Figure 10: Reef slope characteristics at M10 (1 Sept 2019). .....	19
Figure 11: Percentage benthic composition at site M10 $\pm$ SE (1 Sept 2019). .....	19
Figure 34: Abundance of common phylum of zooplankton from sites PKT 1 to PKT 7. ....	25
Figure 35: Total abundance of zooplankton from sites PKT 1 to PKT 7. ....	26
Figure 36: Abundance of copepods from sites PKT 1 to PKT 7. ....	26
Figure 37: Abundance of diatoms and dinoflagellates from sites PKT 1 to PKT 7. ....	27
Figure 38: Total abundance of phytoplankton from sites PKT 1 to PKT 7. ....	27

---

## 1 Introduction

The marine environment survey of Thilafushi covered the shallow lagoon, deep lagoon, reef-flat, and reef slope of the house reef of areas of Thilafushi Island. Thilafushi consists of deep, shallow lagoon, reef flat and reef slope areas. More than half of the shallow lagoon or reef flat area is now reclaimed. The south wing of Thilafushi is wider compared to north wing. The widest reef flat area is on the south wing on the west side of the reef. The enclosed deep lagoon area towards east is well protected with very restricted water movement. This area is used by vessels as a mooring basin. The stagnant water coupled with waste dumping in this area has degraded the lagoon environment on the east side. The deep lagoon of this area has very low visibility, the bottom substrate of the deep lagoon consists mainly of sand. Towards the east of deep lagoon, the bottom substrate is mainly mud and garbage debris.

## 2 Scope of work

The marine survey at Thilafushi has been conducted to cover the marine component of the TOR for the EIA for the Establishment of the Regional Waste Management Center for Zone III issued by EPA. Hence the TOR requested to assemble, evaluate and present baseline data on the relevant environmental characteristics of the study area, focused on the marine environment. Aspects of the environment shall be described to the extent necessary for assessment of the environmental impacts of the proposed development. The extent and quality of the available data shall be characterized indicating significant information deficiencies and any uncertainties associated with the prediction of impacts.

All available data from previous studies, if available shall be presented. Information required includes the following:

*Assessment of the marine environment should be undertaken from all locations from which data was taken in 2011 EIA report. This assessment should cover coral cover and fish census information. Plankton Assessment from 05 different locations around Thilafushi. Areas of special sensitivity including coral reefs and marine protected areas near Thilafushi shall be marked on a map and described. This shall include environmentally sensitive areas, protected areas and significant dive sites.*

## 3 Methodology

A coral reef survey of Thilafushi reef was carried out to establish a baseline of the existing coral reef environment. The baseline assessment assessed the diversity and abundance of coral reef, fish, and significant invertebrates that are commonly associated with the reef environment of Maldives. The method involved determining percentage of various benthic substrate (categories) using standard benthic categories for coral reef benthic substrate sampling as described by Hodgson et.al (2006) in Reef Check Instruction Manual: A Guide to Reef Check Coral Reef Monitoring.

Site selection for the marine survey was based on the location of the WTE, existing dumpsite, and proposed hotwater outfall and seawater intake and as well as control sites for future monitoring purposes. At survey sites M1 to M7 benthic composition and fish abundance was surveyed at depths of 5 meters and 10 meters and at survey sites M8 to M10, surveys were done to a depth of 30 metres along the reef profile. A Manta Tow survey was conducted along 500 metres from M9 to M10 along the reef edge on the southern side of Thilafushi at both 5 and 10 metres. The inner lagoon was not surveyed as the area is not of ecological importance.

The marine benthic and fish surveys at Thilafushi Island was focused on 10 sites. Plankton tows and water samples were done at 7 sites on 23<sup>rd</sup> – 24<sup>th</sup> April 2018. Marine surveys were done at marine sites M1 to M7 on 23<sup>rd</sup> – 24<sup>th</sup> April 2018. Three sites, M8 to M10 were surveyed on 1<sup>st</sup> September 2019 as more detail marine survey was requested to locate the hot water discharge location on southern side of Thilafushi. These three sites were chosen within a 500 m zone on the southern side of Thilafushi as shown in Figure 3. M8 was one of the potential site to locate the hot water discharge outfall.



Figure 1: Marine surveyed locations with coordinates in 23<sup>rd</sup> – 24<sup>th</sup> April 2018 and 1<sup>st</sup> September 2019

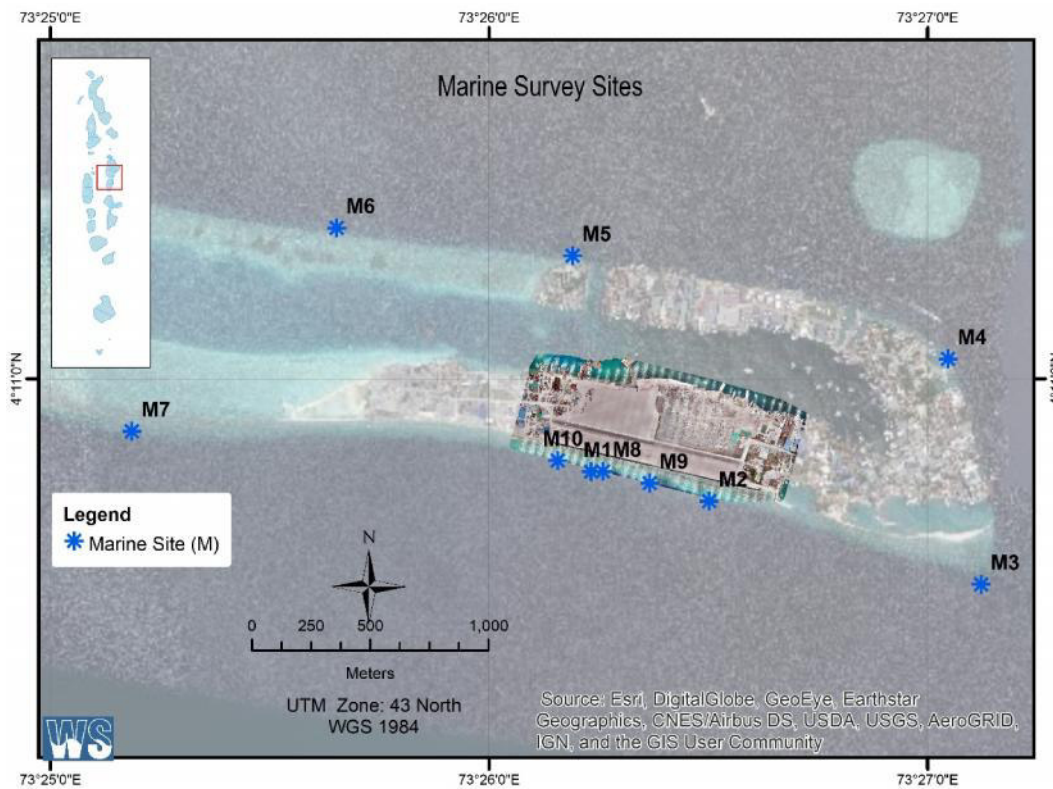


Figure 2: Marine surveyed locations with coordinates in 23<sup>rd</sup> – 24<sup>th</sup> April 2018 and 1<sup>st</sup> September 2019

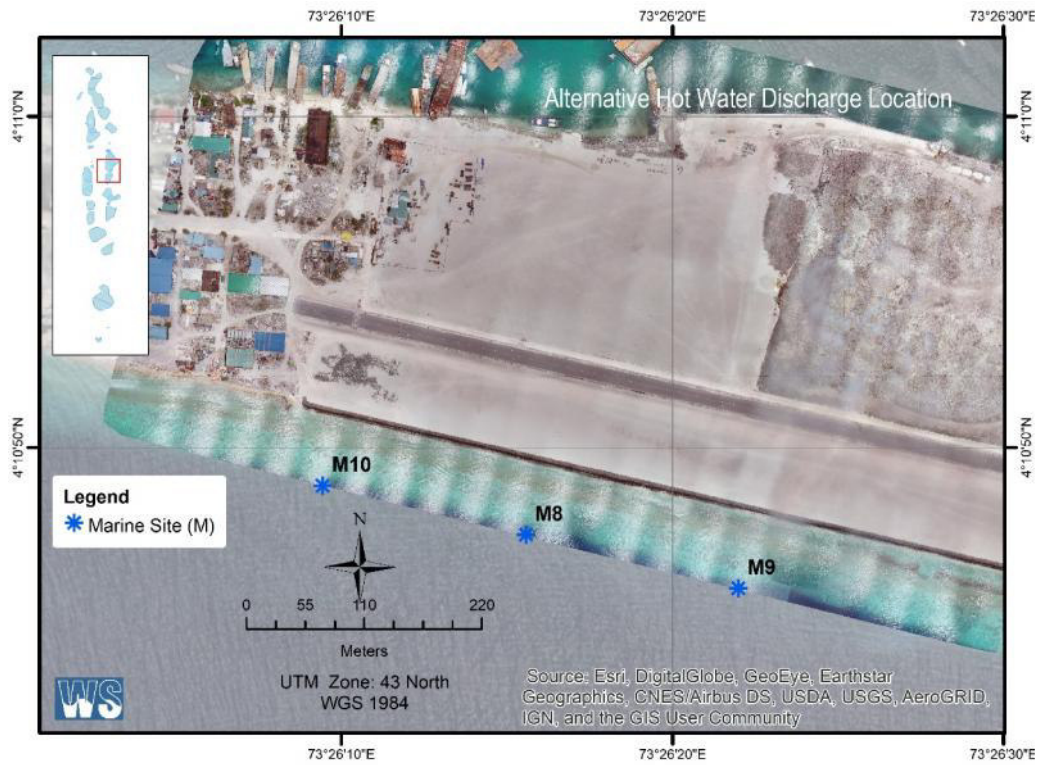


Figure 3: Marine surveyed locations on 1<sup>st</sup> September 2019

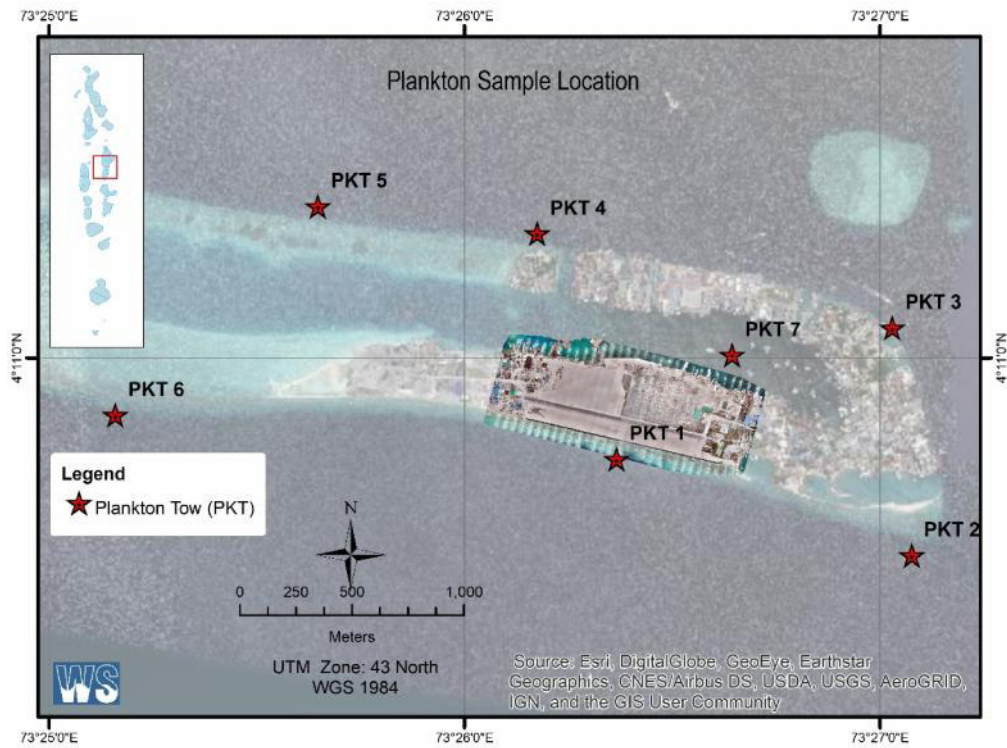


Figure 4: Plankton tows and water sampled location on 23<sup>rd</sup> – 24<sup>th</sup> April 2018

---

### **3.1 Benthic Survey**

All surveys were carried out by underwater SCUBA diving. The marine surveys were carried out by surveyors who had been trained to undertake Reef Check surveys as outlined in the Reef Check Instruction Manual: A Guide to Reef Check Coral Reef Monitoring (2006). Based on the Guide to Reef Check Coral Reef Monitoring (2006) photo quadrat surveys were done in order to measure the benthic composition 10 sites (M1-M10) located on areas on the outer reef around Thilafushi island. At the survey sites M1 to M7 benthic composition and fish abundance was surveyed at depths of 5 meters and 10 meters. At survey sites M8 to M10, marine surveys were done to a depth of 30 metres along the reef profile.

#### **3.1.1 Surveys in April 2018**

The photo quadrat surveys were undertaken at marine site M1 to M7. A transect line of 20 metres at each site is set out, the surveyor then places a half a metre quadrat made from PVC along the transect line and takes a photo directly from vertically above. The second photo is then taken along in the same manner after approximately 1 m away from the first photo. In this manner, photos are taken along the transect line and in total, 10 photos on each transect line are taken. In each of the sites 4 transects were placed in two depths (5 & 10m). The surveys were undertaken on 23-24 April 2018.

#### **3.1.2 Reef profile Survey in September 2019**

Marine survey sites M8 to M10, were three additional sites surveyed using photo quadrat methods. Unlike the conventional reef transect surveys, the three sites were assessed for benthic composition by undertaking photo quadrates from the top reef up to 30 metres, along the reef profile.

Before start of the survey, the starting points were marked using a plastic bottle tied with a rope and weight at its end. The weight rested at the top reef, approximately 5 metres from the reef slope. This allowed the divers to descent from the exact required location up to 30 metres.

Photos were taken using the half metre quadrat made from PVC along the transect line (vertical) and takes a photo directly from above. The second photo is then taken along in the same manner after approximately 1 m below the first photo. In this manner, photos are taken along the transect line.

#### **3.1.3 Manta Tow survey in September 2019**

A Manta Tow survey was conducted along 500 metres from M9 to M10 along the reef edge on the southern side of Thilafushi at both 5 and 10 metres. Manta towed was conducted by swimming along the stretch and recording the observations on an underwater slate. The tow at 5 metres was undertaken with the help of a boat which towed the swimmer along the survey stretch using a rope.

The parameters observed include percentage cover of live coral, other benthic organisms, substrate diversity of the reef in terms of benthic and pelagic life. Overall status of the reef along this stretch was determined based on this survey and the results are outlined below.

## **4 Data Processing methodology**

Analysis of the photos was done using a computer program called, CPCe (Coral Point Count with Excel extensions). This is an internationally recognized software used all over the world to assess the benthic composition of the reefs. In this programme, photographs are analyzed using pre-defined benthic categories. Depending on the type of survey, these categories can be user defined at any given level. Users can have very complex levels ranging from individual coral families or have broader assessment categories. As the objective of this survey was to assess the impact of dredging and reclamation, it made sense to use a broader categories. Hence, benthic categories adopted by the Reef Check protocol were utilized. A text file containing these categories was created and imported to CPCe. The Reef Check protocol allows categorizing life forms followed under the Reef Check protocol, which emphasizes on benthic composition categorizing such as hard corals, sand, rock and others. The emphasis is not on recording corals to their species levels, but rather the general coral and other life forms such as hard and soft corals. This method is more accurate as the percentage of healthy coral cover and other life forms can be more accurately recorded even by a non-experienced surveyor.



---

The following are definition of benthic categories used in this survey.

- **HC:** All living coral including bleached coral; includes fire, blue and organ pipe corals
- **SC:** Include zoanths but not anemones (OT)
- **DC:** Coral that has died within the past year; appears fresh and white or with corallite structures still recognizable
- **ALG:** All macro-algae except coralline, calcareous and turf (record the substrate beneath for these); Halimeda is recorded as OT; turf is shorter than 3cm.
- **SP:** All erect and encrusting sponges (but no tunicates).
- **RC:** Any hard substrate; includes dead coral more than 1 year old and may be covered by turf or encrusting coralline algae, barnacles, etc.
- **RB:** Reef rocks between 0.5 and 15cm in diameter
- **SD:** Sediment composed of particles of less than 0.5cm in diameter; in water, falls quickly to the bottom when dropped.
- **SI:** Sediment that remains in suspension if disturbed; recorded if color of the underlying surface is obscured by silt.
- **OT:** Any other sessile organism including sea anemones, tunicates, gorgonians or non-living substrate.
- **SG:** All types of sea grass observed categorized in the field SG.

Each of the 10 photos from transect are imported, cropped and prepared for analysis. The CPCe program then generates a matrix of random points overlaid on the image for each point to be visually identified. Users can then input the defined categories for each photo and once all the photos are analysed, the results are displayed on a table.

## 5 Results of the marine survey

### 5.1 Status of site 1 (M1)

Site 1 was selected from the Southern rim of the island reef. The site was chosen as the site was adjacent to the proposed waste rehabilitation centre. The substrate at the site is dominated by rock at depths of 5 ( $58 \pm 14.2\%$ ) and 10 ( $64.5 \pm 2.78$ ) meters respectively. Hard coral cover was observed to be moderate at the site at depths of 5 ( $19.5 \pm 5.91$ ) and 10 ( $21 \pm 2.68$ ) meters. Massive porites were the dominating the group of hard coral observed at the site at both the depths. Fishes observed to be abundant at a depth of 5 meters were surgeon fishes, damselfishes and butterfly fishes. Fishes observed to be abundant at a depth of 10 meters were anthias, damselfishes and triggerfishes. The following graph outlines the status of site 1(M1) at depths of 5 and 10 meters.

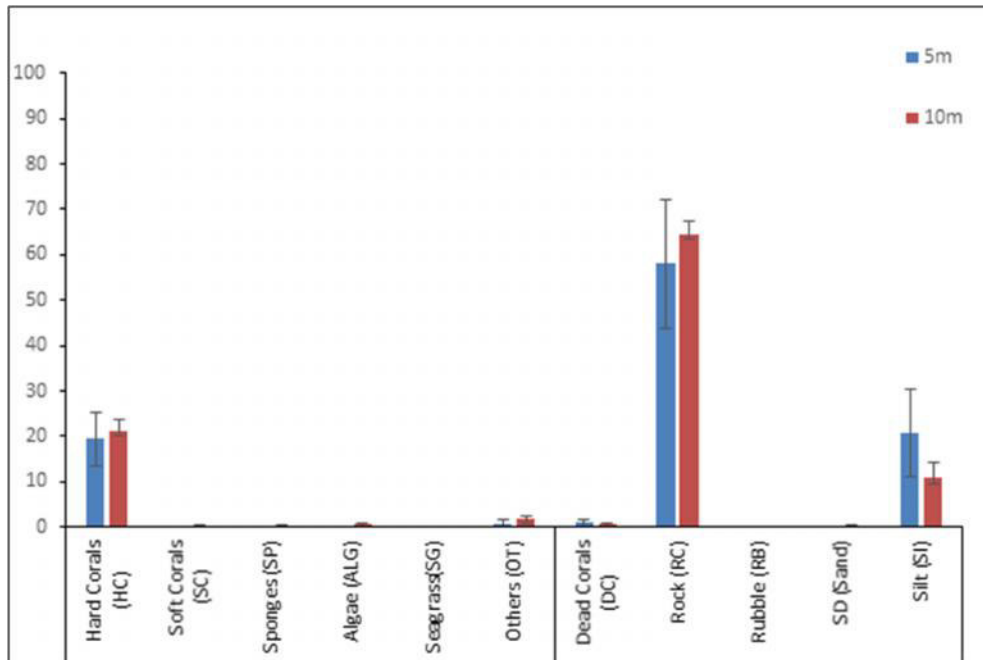


Figure 5: Percentage benthic composition at site 1(M1) at depths of 5 and 10 meters  $\pm$  Standard Error (SE) (23<sup>rd</sup> April 2018).

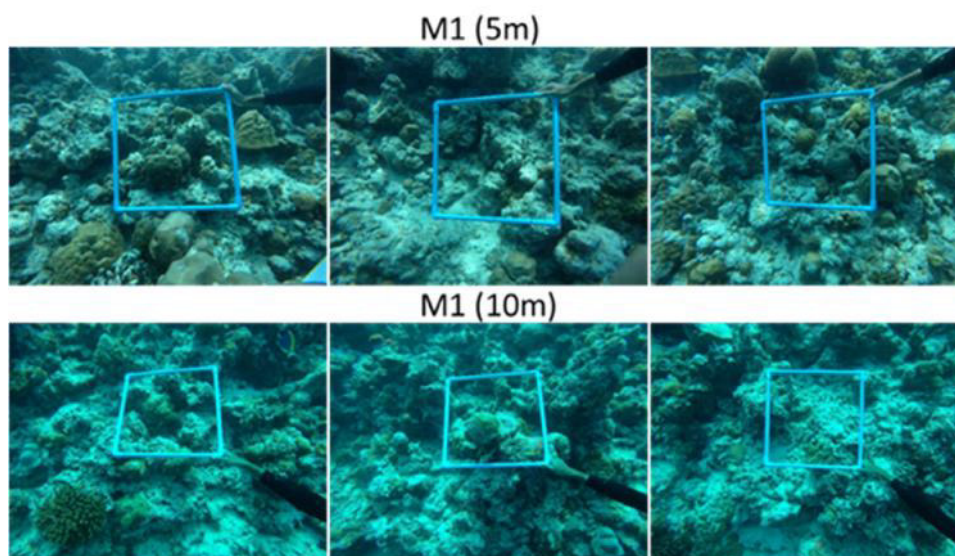


Figure 6: Photos taken from site 1 at depths of 5 and 10 meters (M1) (23<sup>rd</sup> April 2018).

## 5.2 Status of site 2 (M2)

Site 2 was selected from the Southern rim of the island reef east of site 1. The site was chosen as the site was adjacent to the proposed waste rehabilitation centre. The substrate at the site is dominated by rock at depths of 5 ( $71.25 \pm 3.86\%$ ) and 10 ( $63 \pm 6.14\%$ ) meters respectively. Hard coral cover was observed to be moderate at the site at depths of 5 ( $22.25 \pm 2.95\%$ ) and 10 ( $23.25 \pm 5.17\%$ ) meters. Massive porites were the dominating group of hard coral observed at the site at both the depths. Fishes observed to be abundant at depth of 5 meters were anthias, surgeon fishes, damselfishes, parrotfishes, triggerfishes and butterfly fishes. Fishes observed to be abundant at depth of 10 meters were anthias, damselfishes, butterfly fishes and triggerfishes. The following graph outlines the status of site 2(M2) at depths of 5 and 10 meters.

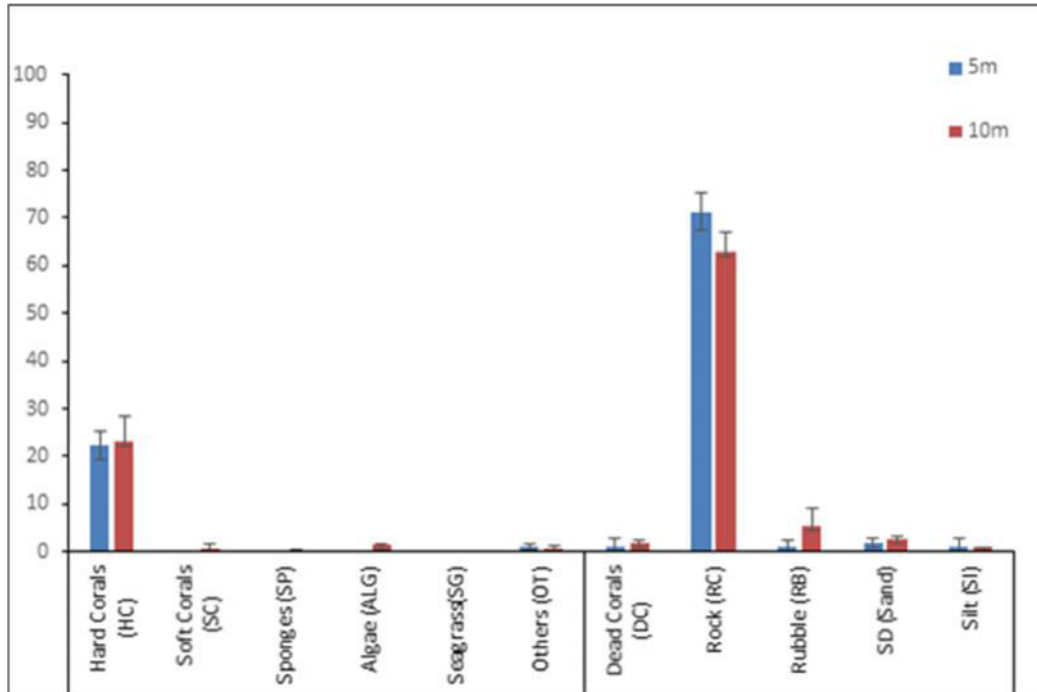


Figure 7: Percentage benthic composition at site 2 (M2)  $\pm$  SE (24<sup>th</sup> April 2018).

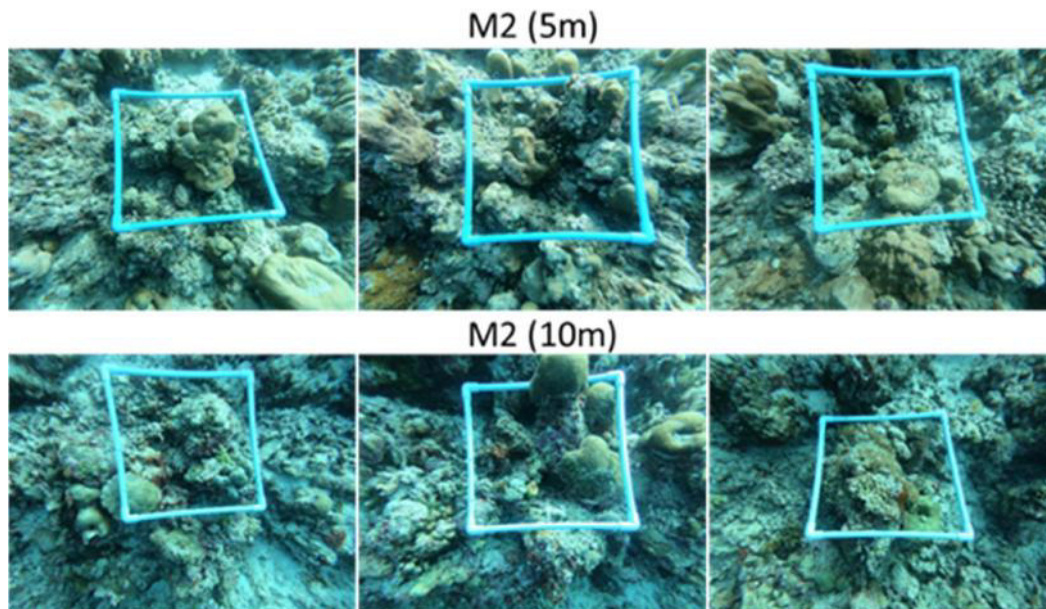


Figure 8: Photos taken from site 2 (M2) (24<sup>th</sup> April 2018).

### 5.3 Status of site 3 (M3)

Site 3 was selected from the Southern eastern corner of the island reef. The site was chosen as a control site as well as to get a broader understanding of the ecological baseline around the reef. The substrate at the site is dominated by rock at depths of 5 ( $76.25 \pm 2.10\%$ ) and 10 ( $65.75 \pm 2.46\%$ ) meters respectively. Hard coral cover was observed to be moderate at the site at depths of 5 ( $17 \pm 2.48$ ) and 10 ( $16.5 \pm 0.65$ ) meters. Massive porites were the dominating group of hard coral observed at the site at both the depths. Fishes observed to be abundant at a depth of 5 meters were surgeon fishes and jacks and trevallies. Fishes observed to be abundant at a depth of 10 meters were anthias, damselfishes and triggerfishes. The following graph outlines the status of site 3(M3) at depths of 5 and 10 meters.

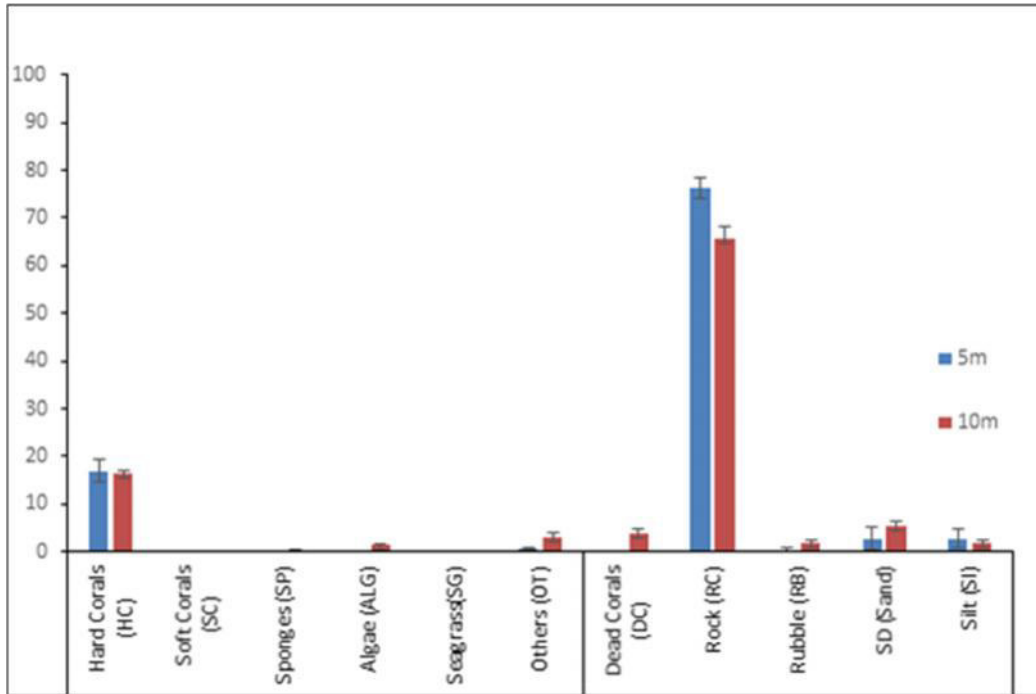


Figure 9: Percentage benthic composition at site 3 (M3) ± SE (23<sup>rd</sup> April 2018).

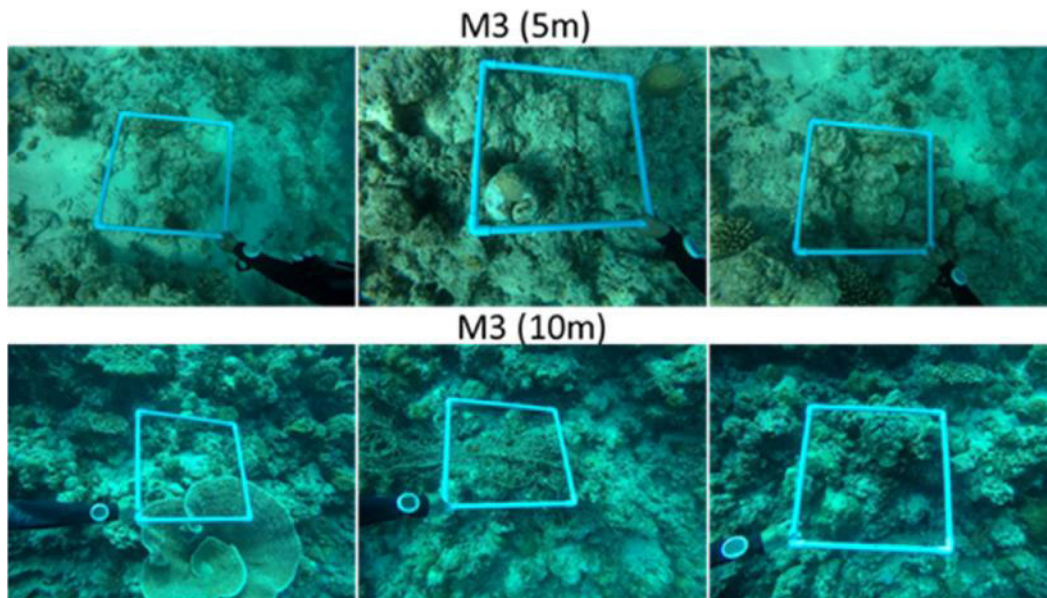


Figure 10: Photos taken from site 3 (M3) (23<sup>rd</sup> April 2018).

### 5.4 Status of site 4 (M4)

Site 4 was selected from the North-eastern rim of the island reef. The site was chosen as a control site as well as to get a broader understanding of the ecological baseline around the reef. The substrate at the site is dominated by rubble at depths of 5 ( $67 \pm 4.49\%$ ) and 10 ( $60 \pm 6.42\%$ ) meters respectively. Hard coral cover was not observed at the site at depths of 5 and 10 meters. Fishes observed to be abundant at a depth of 5 meters were surgeon fishes, butterfly fishes and fusiliers. Fishes observed to be abundant at a depth of 10 meters were only fusiliers. The following graph outlines the status of site 4(M4) at depths of 5 and 10 meters.

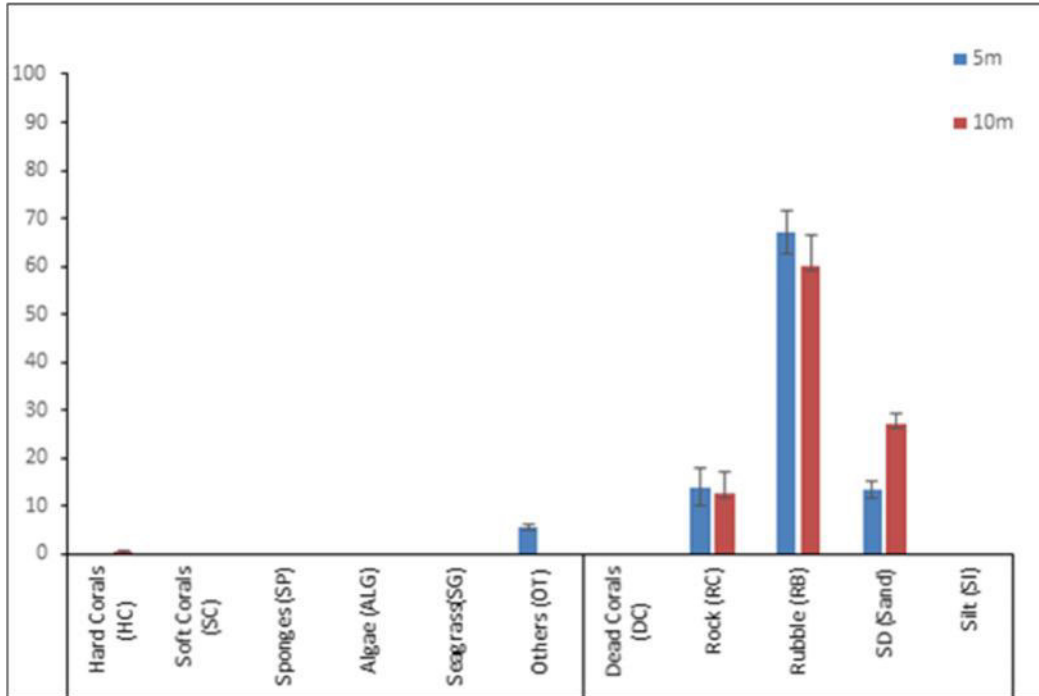


Figure 11: Percentage benthic composition at site 4 (M4)  $\pm$  SE (24<sup>th</sup> April 2018).

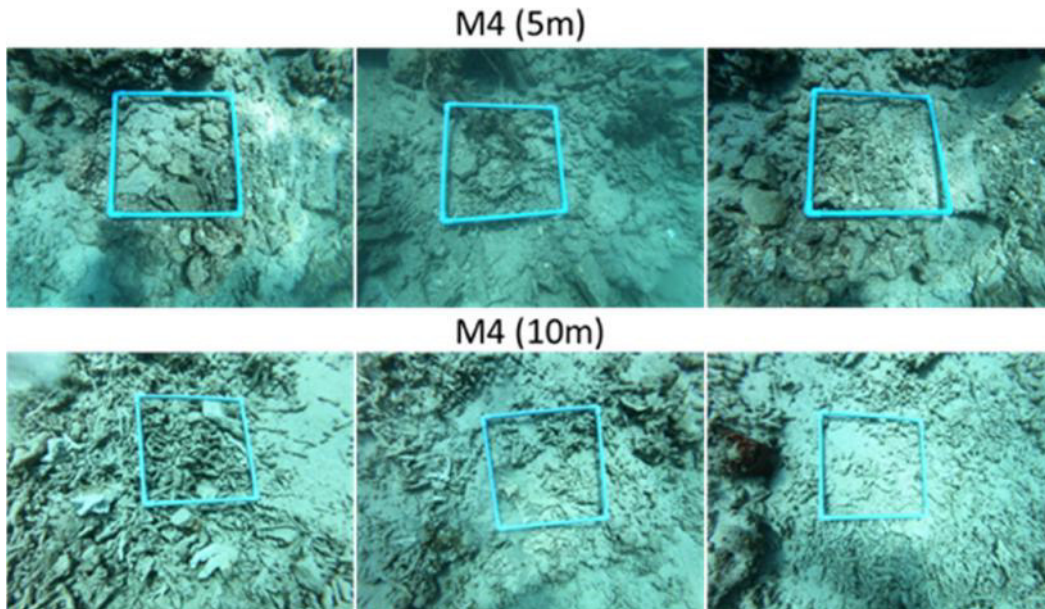


Figure 12: Photos taken from site 4 (M4) (24<sup>th</sup> April 2018).

### 5.5 Status of site 5 (M5)

Site 5 was selected from the Northern rim of the island reef close proximity to the entrance channel. The site was chosen as a control site as well as to get a broader understanding of the ecological baseline around the reef. The substrate at the site is dominated by rock at depths of 5 ( $46.75 \pm 6.28\%$ ) and 10 ( $51.5 \pm 5.81\%$ ) meters respectively. Hard coral cover was observed to be low at the site at depths of 5 ( $5 \pm 1.58$ ) and 10 ( $4.25 \pm 0.75$ ) meters. Massive porites were the dominating group of hard coral observed at the site at both the depths. Fishes observed to be abundant at a depth of 5 meters were surgeon fishes and parrotfishes. Fishes observed to be abundant at a depth of 10 meters were surgeon fishes, damselfishes and triggerfishes. The following graph outlines the status of site 5(M5) at depths of 5 and 10 meters.

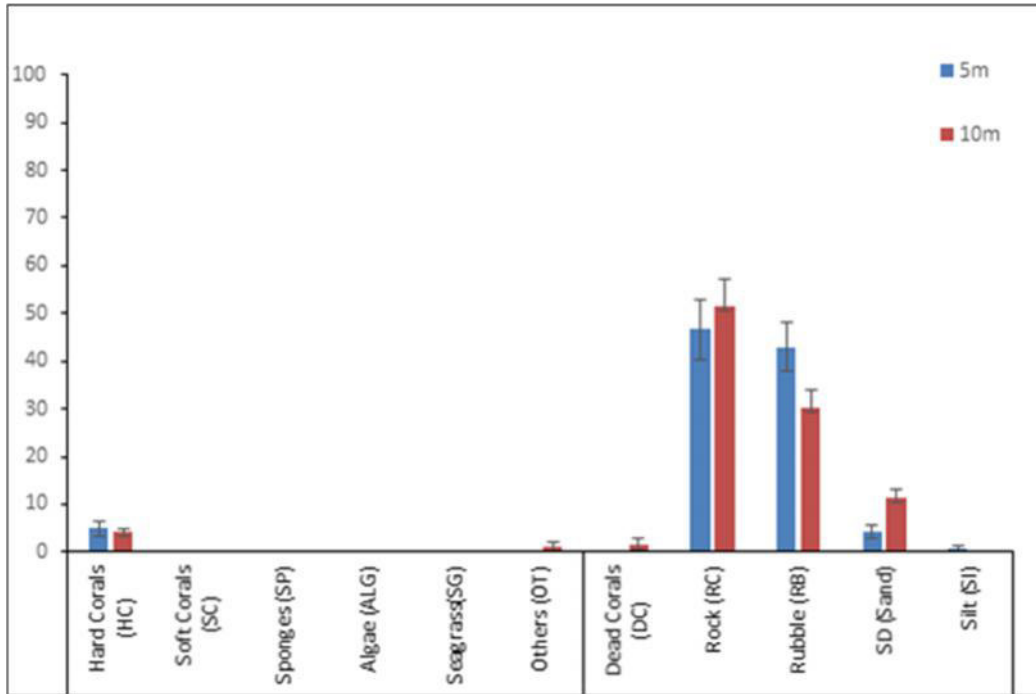


Figure 13: Percentage benthic composition at site 5 (M5)  $\pm$  SE (24<sup>th</sup> April 2018).

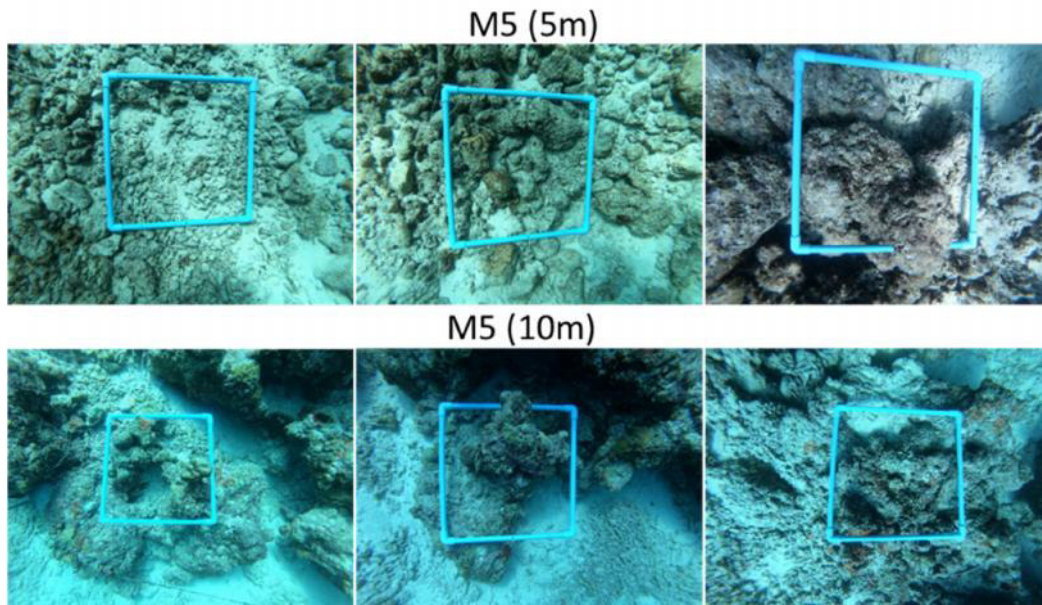


Figure 14: Photos taken from site 5 (M5) (24<sup>th</sup> April 2018).

## 5.6 Status of site 6 (M6)

Site 6 was selected from the Northern rim of the island reef west of site 5. The site was chosen as a control site as well as to get a broader understanding of the ecological baseline around the reef. The substrate at the site is dominated by rock at depths of 5 ( $80.5 \pm 4.19\%$ ) and 10 ( $36.5 \pm 5.85\%$ ) meters respectively. Hard coral cover was observed to be low at the site at depths of 5 ( $8.75 \pm 2.53$ ) and 10 ( $14 \pm 2.58$ ) meters. Particular group of hard corals were not observed to dominate the substratum. A diverse group of corals from groups such as *Acropora*, *Pocillopora* and *Porites* were observed at the site. Fishes observed to be abundant at a depth of 5 meters were surgeon fishes, wrasses, triggerfishes, damselfishes and butterfly fishes. Fishes observed to be abundant at a depth of 10 meters were surgeon fishes, damselfishes, triggerfishes and butterfly fishes. The following graph outlines the status of site 6(M6) at depths of 5 and 10 meters.

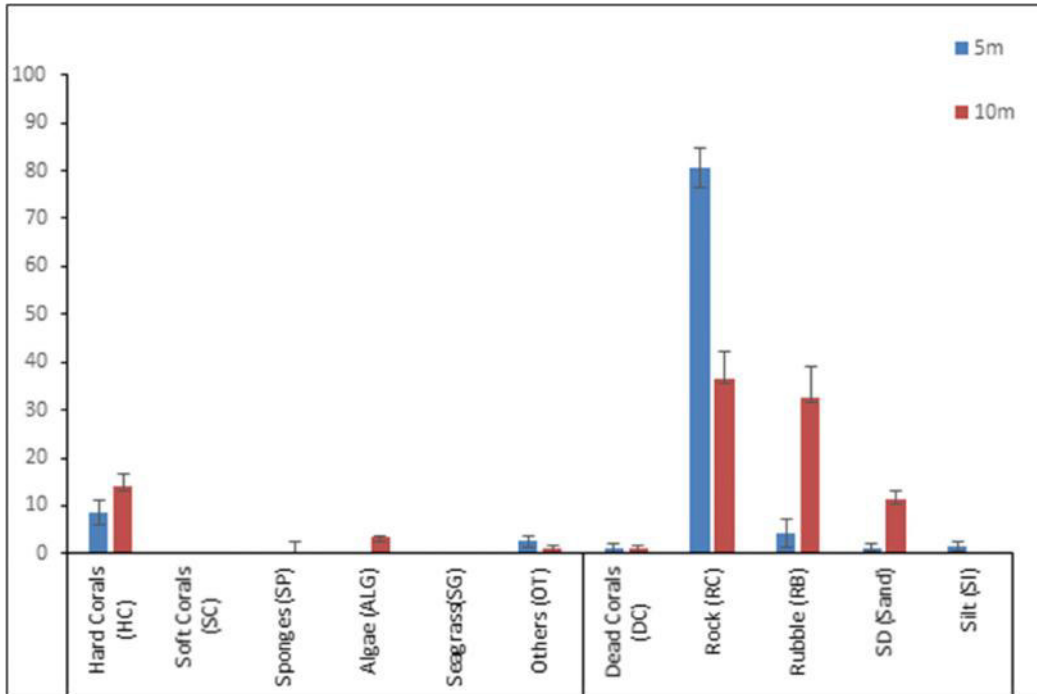


Figure 15: Percentage benthic composition at site 6 (M6)  $\pm$  SE (24<sup>th</sup> April 2018).

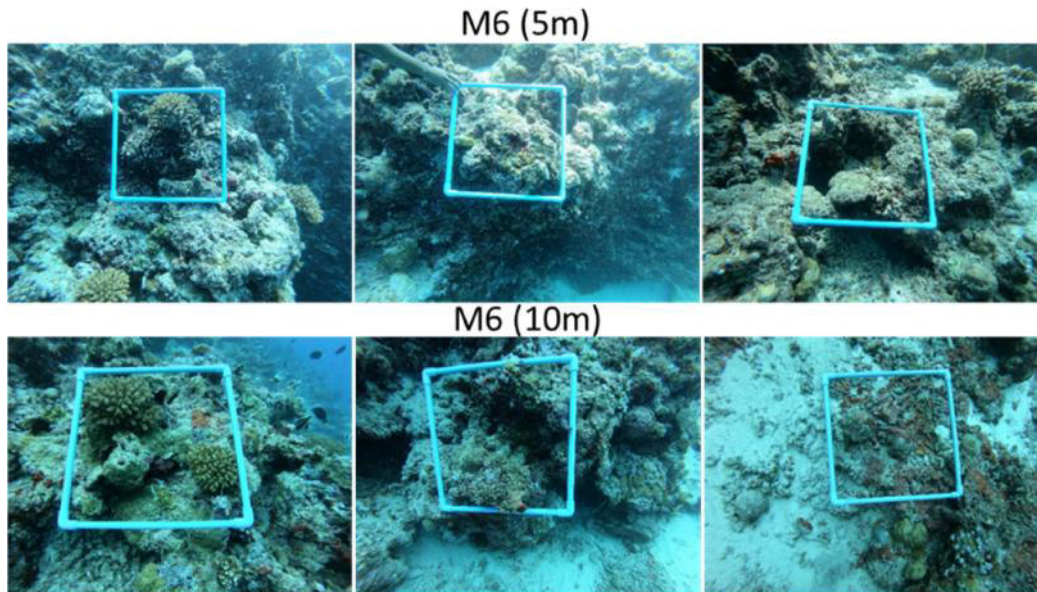


Figure 16: Photos taken from site 6 (M6) (24<sup>th</sup> April 2018).

### 5.7 Status of site 7 (M7)

Site 7 was selected from the Southern rim of the island reef west of site 1. The site was chosen as a control site as well as to get a broader understanding of the ecological baseline around the reef. The substrate at the site is dominated by rock at depths of 5 ( $76 \pm 5.87\%$ ) and 10 ( $77.75 \pm 3.33\%$ ) meters respectively. Hard coral cover was observed to be low at 5 meters ( $5 \pm 1\%$ ) and moderate in 10 meters ( $17.5 \pm 3.2$ ). Massive porites were the dominating group of hard coral observed at the site at both the depths. Fishes observed to be abundant at a depth of 5 meters were surgeon fishes, damselfishes and butterfly fishes. Fishes observed to be common at a depth of 10 meters were surgeon fishes. The following graph outlines the status of site 7(M7) at depths of 5 and 10 meters.

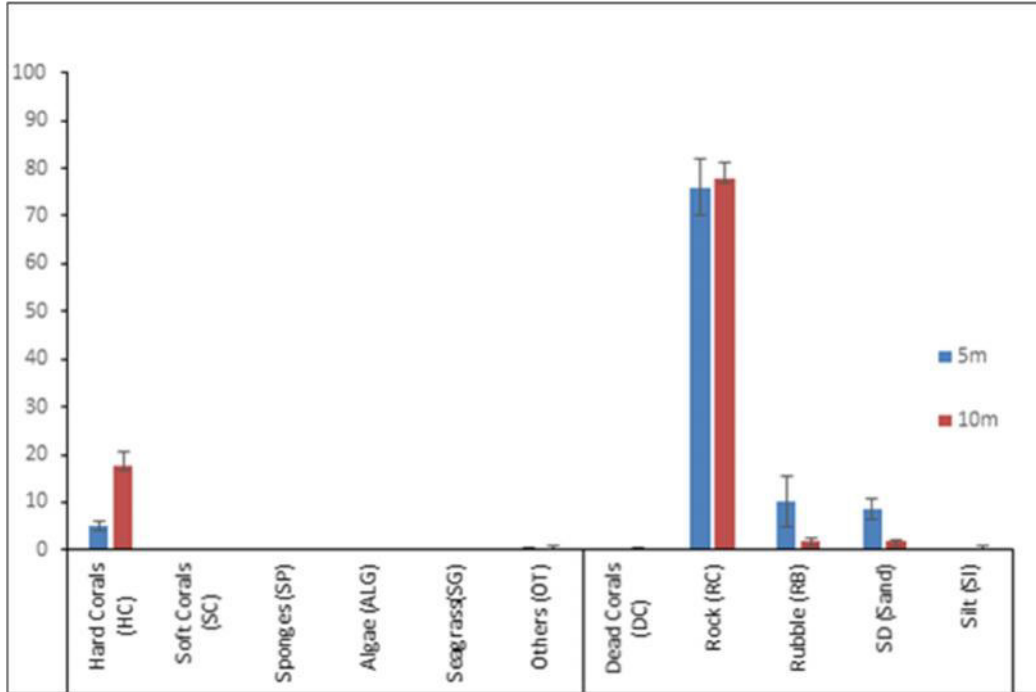


Figure 17: Percentage benthic composition at site 7 (M7)  $\pm$  SE (23<sup>rd</sup> April 2018).

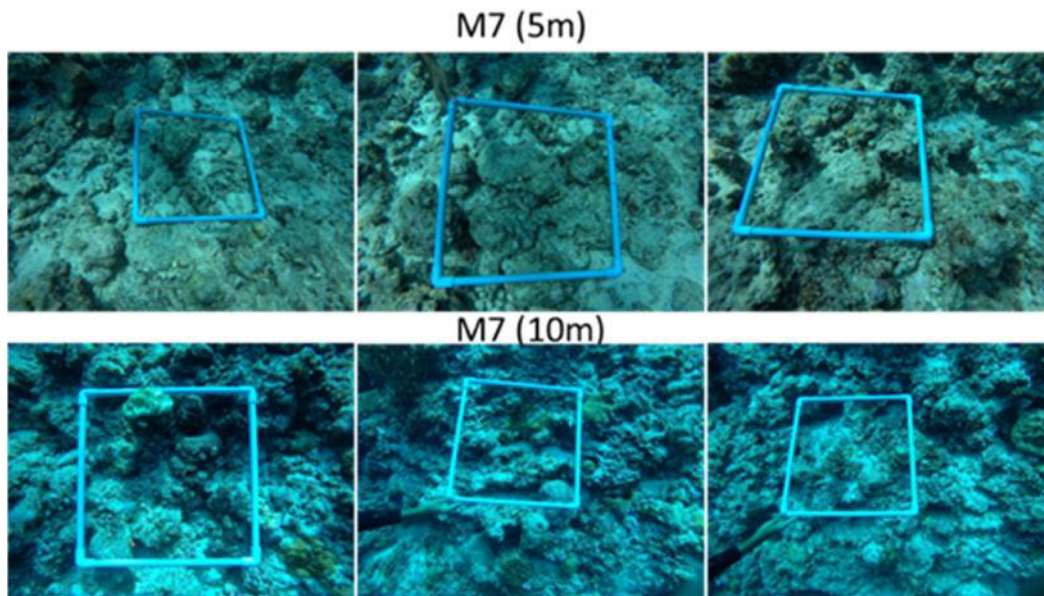


Figure 18: Photos taken from site 7 (M7) (23<sup>rd</sup> April 2018)



### 5.8 Observation during the marine survey in 2019

The highest coral cover was observed at the depth of 10 meters in site M2 adjacent to the current waste dumping area. The results are highlighted in the figure below. Therefore there is the possibility the leachate from land fill are not having negative impacts on the reef at site M2.

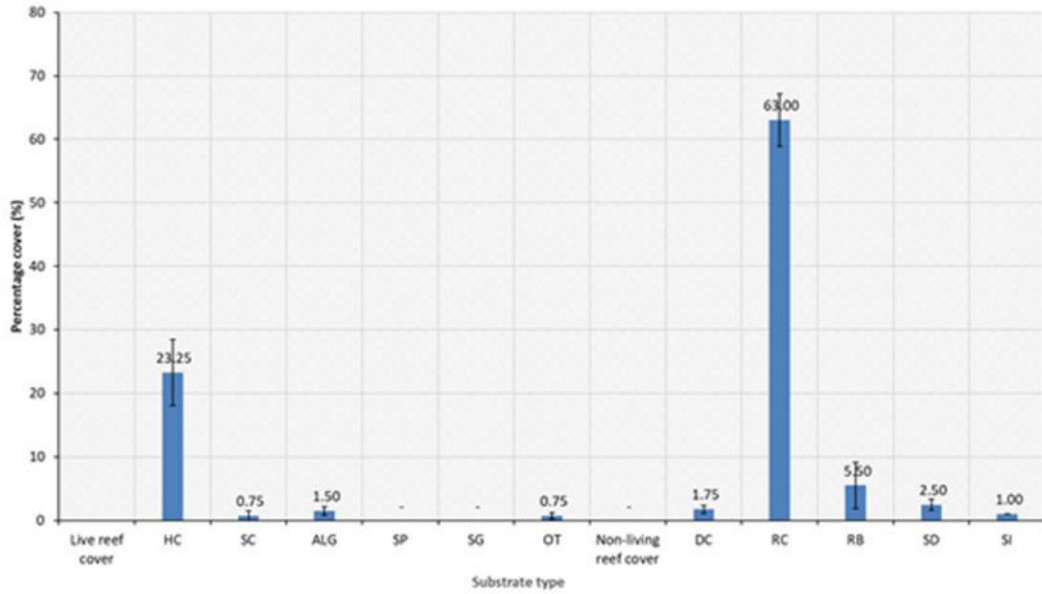


Figure 19: Percentage benthic composition at site 2(M2) at a depth of 10 meter  $\pm$  standard error (SE).

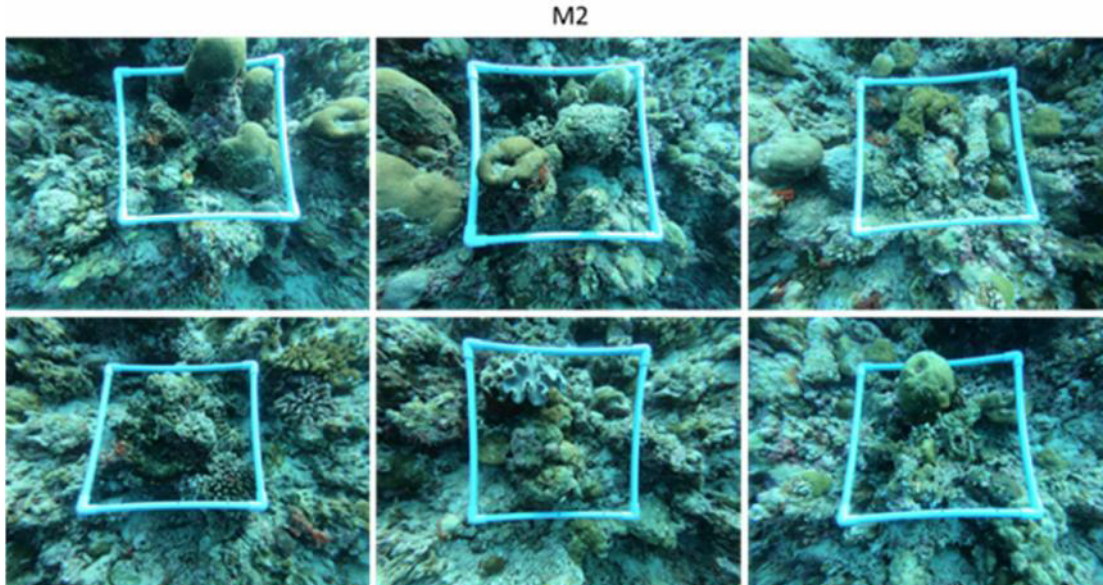


Figure 20: Photos compiled from site 2 (M2) at a depth of 10 meters.

## 5.9 Status of site M8

Site M8 was selected from the Southern rim of the island reef. The site was chosen as this is the proposed location for the hot water discharge outfall. The substrate at the site is dominated by silt along the entire transect line ( $43 \pm 11.69\%$ ). Hard coral cover was observed to be low ( $8 \pm 2.71$ ). Massive porites were the dominating the group of hard coral observed at the site. Fishes observed to be very rare. It is to be noted that just a week prior to the survey, due to the severe weather, this entire stretch of reef has been hit by strong waves causing the sediments on the western side of the Thilafuhi to be spread along most part of the southern side. This has resulted in large areas of the reef being covered with silt. The following image illustrates the reef slope characteristics at site M10.

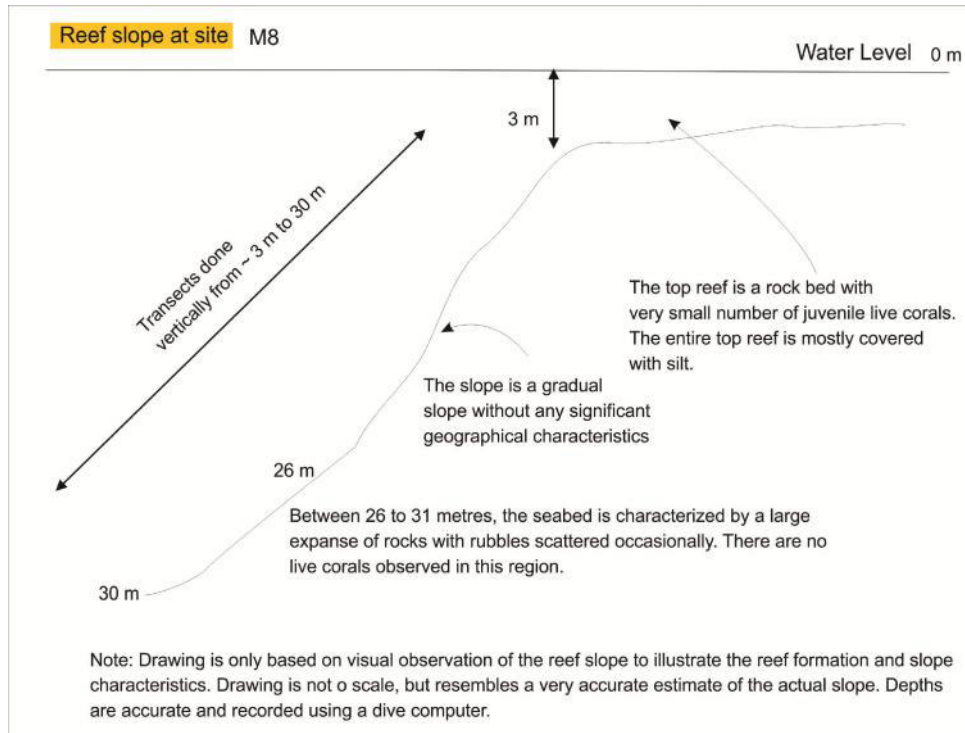


Figure 21: Reef slope characteristics at M8 (1st September 2019).

The following graph outlines the status of site M8.

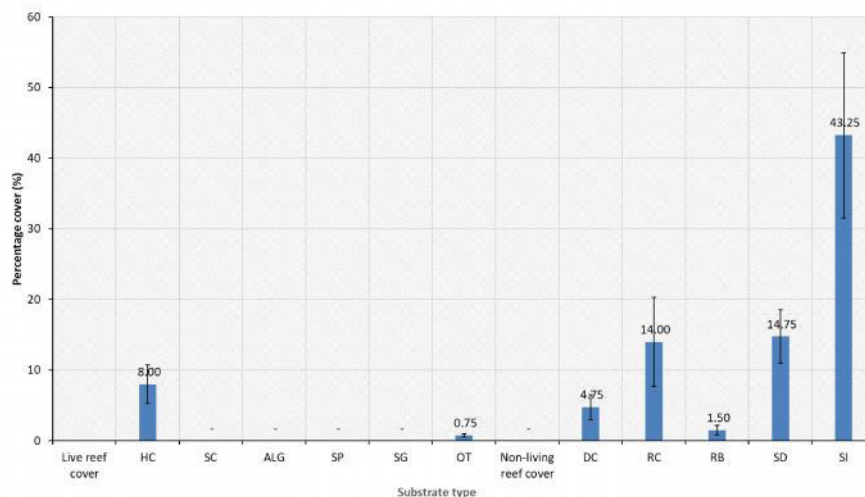


Figure 22: Percentage benthic composition at site M8 at depths from ~ 3 to 30 meters  $\pm$  Standard Error (SE) (1<sup>st</sup> September 2019).

### 5.10 Status of site M9

Site M9 was also selected from the Southern rim of the island reef east of site 1. The substrate at the site is dominated by silt (64.5 ± 3.77%). Hard coral cover was observed to be low along the surveyed depths from approximately 3 to 30 metres (10.75 ± 3.22). Massive porites were the dominating group of hard coral observed at the site. Fishes observed were very low and includes anthias and surgeon fishes (refer to the fish census table for details). The following graph outlines the status of site M9.

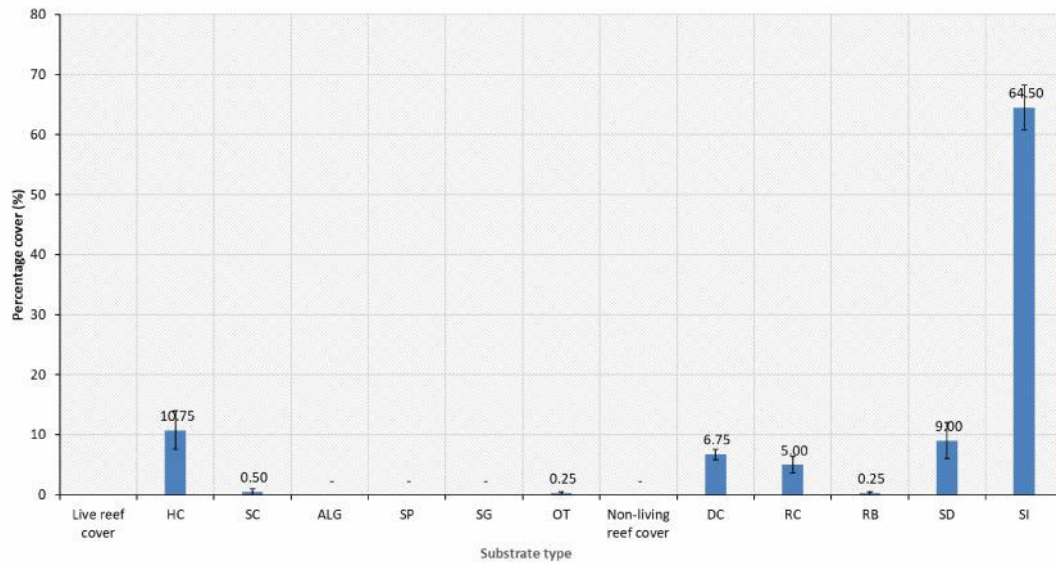


Figure 23: Percentage benthic composition at site M9 at depths from ~ 3 to 30 meters ± SE (1 September 2019). The following image illustrates the reef slope characteristics at site M9.

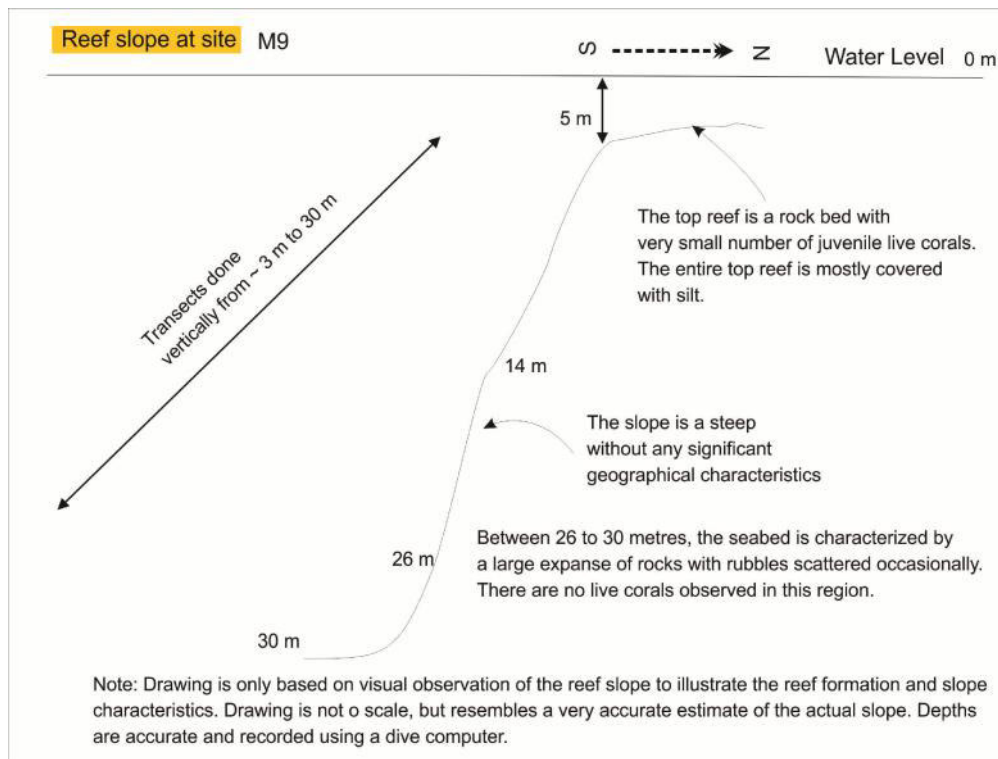


Figure 24: Reef slope characteristics at M9 (1 September 2019).

### 5.11 Status of site M10

Site M10 was also selected from the Southern side of the island reef. The following image illustrates the reef slope characteristics at site M10.

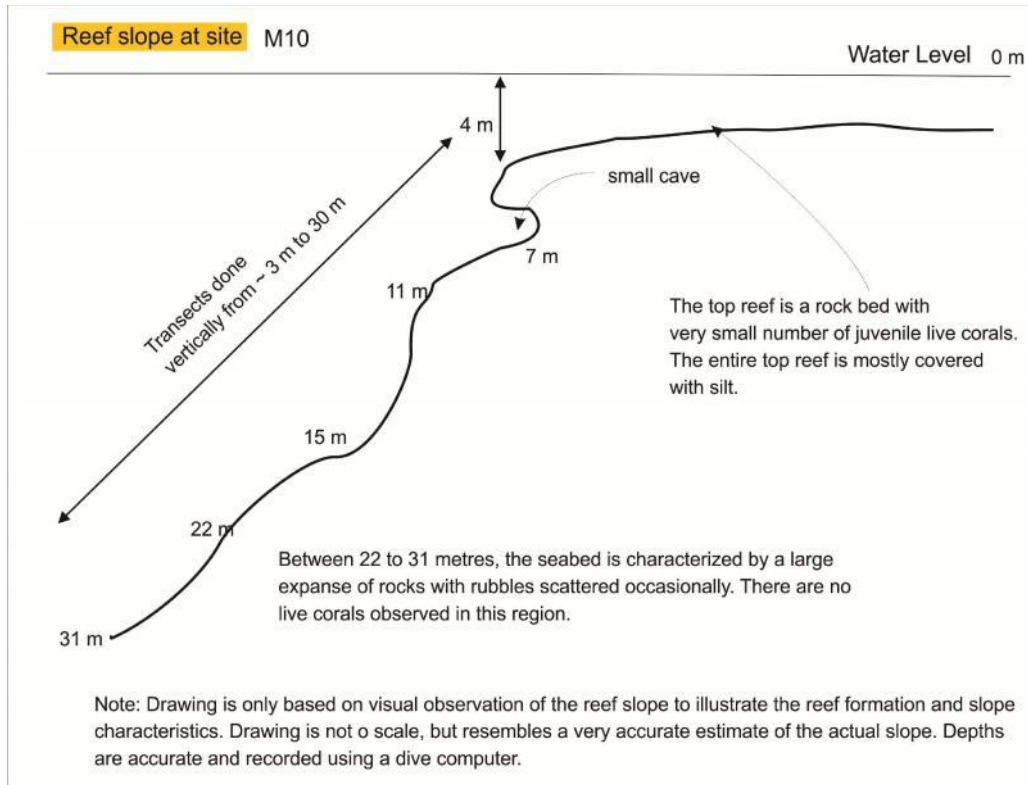


Figure 25: Reef slope characteristics at M10 (1 Sept 2019).

The substrate at the site is dominated by silt ( $58.50 \pm 4.57\%$ ). Hard coral cover was observed to be moderate ( $23.75 \pm 7.43$ ). Massive Porites were the dominating group of hard coral observed at the site. Fishes observed to be very low. The following graph outlines the status of site M10.

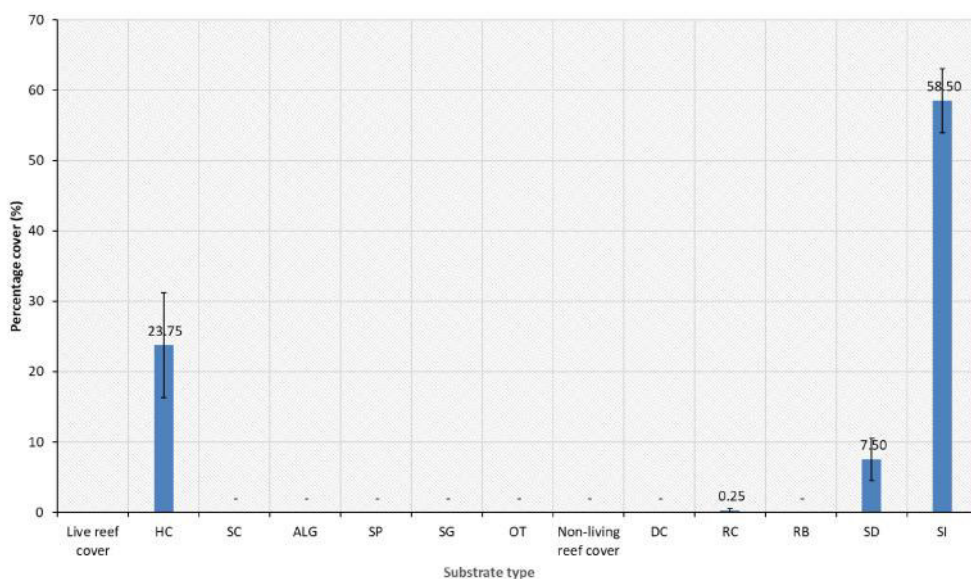


Figure 26: Percentage benthic composition at site M10  $\pm$  SE (1 Sept 2019).

## 5.12 Manta Tow between M9 and M10

The following table outlines the results of the Manta Tow survey that was carried out on 1<sup>st</sup> September from M9 to M10

Table 1: Manta Tow survey results of approximate substrate cover around the reef edge

	Live Coral cover %	Dead coral cover %	Soft corals cover %	Rock cover %	Rubble cover %	Silt cover %	Benthic diversity	Fish diversity
<u>5 metres</u>								
	5	8	-	15	2	70	low	low
<u>10 metres</u>								
	10	6	-	27	7	50	Low	low

The Manta Tow survey showed that coral reef system along the surveyed stretch is not in very good conditions in term of percentage live coral cover, diversity of corals, benthic and pelagic life. The overall live coral cover of the reef system appeared to be approximately 5% at 5 metres and approximately 10% at 10 metres. The reef substrate at both these depths were dominated by silt. Abundance and diversity of fish was also lower along the stretch. The live coral cover was highest at 10 metres. The corals in most abundance were massive type coral head belonging to the genus Porites.

### 5.12.1 Protected marine species

During the Manta tow survey, no protected marine species such as sharks or were observed and recorded.

### 5.12.2 Reef Aesthetics

This attribute was assessed by visual observations based on the observer's judgment and experience of the relative merits of a reefs in the Maldives. This value judgment incorporated coral cover, diversity of life forms, fish life, reef structure and general appeal. The following categories were used to determine aesthetics of the reef system:

- a. Very poor (mostly dead corals, pelagic life not abundant and diversity very low, structure uniform).
- b. b. Poor (Lot of dead corals, pelagic life not abundant and diversity low, some differences in structure).
- c. c. Average (Live corals about 10%, pelagic life abundant, diversity low, some structural variations exists).
- d. d. Good (Live corals about 20% pelagic life abundant, diverse, structural variations exists).
- e. e. Very good (Live corals about 30%, pelagic life abundant, diverse, overhangs, and other structures).
- f. f. Excellent (Live corals over 40%, pelagic life very abundant, very diverse, lots of different structures, overhangs, caves, gullies, and different habitat types exists).

Reef aesthetics of Thilafushi's coral reef system (along the 500 metres) is regarded as very poor, given that substantial level of the reef is covered in silt and poor diversity of life forms. Fish life and abundance are very poor at the time of surveying and generally this stretch of reef can be considered to be very poor.

## 5.13 Fish Diversity and Abundance (April 2018)

The amount and type of fish present at a given site can be a good indicator of the marine environment. For example, increased grazers are generally a sign of increased nutrients in the area, thus decreased coral cover and increased algal cover. 15-minute fish counts were done in sites M1-M7 in depths of 5 and 10m. The counts include Mega fauna in addition to fishes. The fishes were identified to family level, however some protected species such as the napoleon wrasse, were identified to species level. The following table outlines the fish count survey at all the sites.

Table 2: Fish abundances observed at sites 1 to 7 at a depth of 5 and 10 meters.

<b>Family/Subfamily</b>	<b>Site M1</b>		<b>Site M2</b>		<b>Site M3</b>		<b>Site M4</b>		<b>Site M5</b>		<b>Site M6</b>		<b>Site M7</b>	
<b>Depth</b>	<b>5m</b>	<b>10m</b>	<b>5m</b>	<b>10m</b>	<b>5m</b>	<b>10m</b>	<b>5m</b>	<b>10m</b>	<b>5m</b>	<b>10m</b>	<b>5m</b>	<b>10m</b>	<b>5m</b>	<b>10m</b>
Anthias (Anthiadae)	R	A	A	A	R	A	C	-	R	C	C	C	R	-
Surgeonfishes (Acanthuridae)	A	C	A	C	A	C	A	C	A	A	A	A	A	C
Wrasses (Labridae)	C	C	-	C	-	-	C	C	C	C	A	-	C	-
Parrotfishes (Scaridae)	C	C	A	C	R	R	C	R	A	-	C	C	C	-
Triggerfishes (Balistidae)	C	A	A	A	-	A	R	-	C	A	A	A	C	-
Boxfishes (Ostraciidae)	-	-	R	-	-	-	-	-	-	-	-	-	-	-
Damselfishes (Pomacentridae)	A	A	A	A	-	A	C	-	R	A	A	A	A	-
Groupers (Serranidae)	R	-	R	R	R	-	R	-	R	R	R	R	R	-
Moorish idol (Zanclidae)	R	R	R	R	R	R	R	R	C	R	R	R	R	R
Butterflyfishes (Chaetodontidae)	A	C	A	A	C	C	A	C	R	C	A	A	A	-
Goatfishes (Mullidae)	-	-	R	R	-	-	C	C	R	-	R	-	R	-
Hawkfishes (Cirrhitidae)	-	-	R	R	R	-	-	-	R	-	R	-	-	-
Threadfin and Whiptail brems (Scolopsis)	-	-	-	R	-	-	-	-	-	-	-	-	-	-
Octopus (Octopodidae)	-	-	R	-	-	-	-	-	-	-	-	-	-	-
Fusiliers (Caesionidae)	-	-	-	-	-	-	A	A	-	-	-	-	-	-
Rabbitfishes (Siganidae)	-	-	-	-	-	-	R	-	-	-	R	-	-	-
Gobies (Gobiidae)	-	-	-	-	R	-	-	R	R	-	-	-	-	-
Pipefishes and seahorses (Syngnathinae)	-	-	-	-	-	-	R	-	R	R	-	-	-	-
Puffers (Tetraodontidae)	-	-	-	-	R	-	R	-	C	-	R	-	-	-
Emperors or scavengers (Lethrinidae)	-	-	-	-	-	-	-	-	C	-	R	-	-	-
Jacks and Trevalleys (Carangidae)	-	-	-	-	A	-	-	-	R	-	-	-	-	-

Family/Subfamily	Site M1		Site M2		Site M3		Site M4		Site M5		Site M6		Site M7	
	5m	10m	5m	10m	5m	10m	5m	10m	5m	10m	5m	10m	5m	10m
Angelfishes (Pomacanthidae)	-	-	-	-	-	-	-	-	R	-	R	R	-	-
Lizardfishes (Synodontidae)	-	-	-	-	-	-	-	-	R	-	-	-	-	-
Squirrelfishes, soldierfishes (Holocentridae)	-	-	-	-	-	-	-	-	-	-	R	-	-	-
Grunts and Sweetlips (Haemulidae)	-	-	-	-	-	-	-	-	-	R	R	-	-	-
Eels and Morays (Anguilliformes)	-	-	-	-	-	R	-	-	-	-	-	-	-	-
Napoleon Wrasse ( <i>Cheilinus undulatus</i> )	-	-	-	-	-	R	-	-	-	-	-	-	-	-
Sharks & Rays (Elasmobranchii)	-	-	-	-	-	R	-	-	-	-	-	-	-	-
Sea Turtles (Chelonioidea)	-	-	-	-	-	R	-	-	-	-	-	-	-	-

A= Abundant (Meaning that during the 15-minute time swim survey, species counts were recorded more than 50, hence it is difficult to count their numbers). C=Common (Meaning that during the 15-minute time swim survey, they were spotted occasionally and throughout the survey, but their numbers were less than 50). R=Rare (Meaning that during the survey, only few of these species were observed, often 1 or 2)

### 5.14 Fish Diversity and Abundance (September 2019)

The following table outlines the results of the fish counts along the survey points which was conducted from approximately 3 meters up to 30 meters at each site.

Table 3: Fish abundances observed at sites M8, M9 & M10 on 1<sup>st</sup> September 2019.

Family/Subfamily	Site M8	Site M9	Site M10
Anthias (Anthiadae)	-	C	R
Surgeonfishes (Acanthuridae)	R	C	R
Wrasses (Labridae)	-	-	-
Parrotfishes (Scaridae)	R	-	R
Triggerfishes (Balistidae)	-	-	-
Boxfishes (Ostraciidae)	-	-	-
Damselfishes (Pomacentridae)	-	-	-
Groupers (Serranidae)	-	-	-
Moorish idol (Zanclidae)	-	-	-
Butterflyfishes (Chaetodontidae)	-	-	-
Goatfishes (Mullidae)	-	-	-
Hawkfishes (Cirrhitidae)	-	-	-
Threadfin and Whiptail breams (Scolopsis)	-	-	-
Octopus (Octopodidae)	-	-	-
Fusiliers (Caesionidae)	R	-	R
Rabbitfishes (Siganidae)	-	-	-
Gobies (Gobiidae)	R	-	R
Pipefishes and seahorses (Syngnathinae)	-	-	-
Puffers (Tetraodontidae)	-	-	-
Emperors or scavengers (Lethrinidae)	-	-	-
Jacks and Trevallies (Carangidae)	-	-	-

A= Abundant (Meaning that during the 15-minute time swim survey, species counts were recorded more than 50, hence it is difficult to count their numbers). C=Common (Meaning that during the 15-minute time swim survey, they were spotted occasionally and throughout the survey, but their numbers were less than 50). R=Rare (Meaning that during the survey, only few of these species were observed, often 1 or 2).



---

### **5.14.1 Plankton tows**

Plankton are the base of the marine food chain. The phytoplankton and zoo plankton abundances in the area could possibly be affected by the presence of heavy metals. If the plankton community is thriving in these areas the heavy metals maybe bio accumulating in the food chain. Therefore plankton counts were done around Thilafushi Island in order to establish a baseline. A plankton net of 50µm mesh was built to carry out the survey. The plankton tows were carried out at sites where the marine water samples were collected.

#### **5.14.1.1 Data Collection methodology**

A plankton net of opening 0.48 x 0.48 m was tied to a 20m rope and released from a vessel. The net was allowed to drift for 20 meters and then towed towards the boat. Any organisms or particles larger than 50µm gets caught up in the net and collected in the cod end.

#### **5.14.1.2 Data processing methodology**

##### **5.14.1.2.1 Zooplankton**

Analyses of the samples were done using a microscope using a Sedgewick rafter counting chamber. The chamber has a volume of approximately 1ml. The samples collected from the net were approximately 150 – 250ml in volume. For the zooplankton count, the samples were transferred to a beaker diluted to approximately 500 – 900 ml and the volume recorded. The purpose of dilution is to reduce the number of plankton in the optical view of the microscope for ease of counting. Two sub-samples were counted from each sample. To calculate Total count in the sample, the counts in the subsamples were averaged. Thereafter the average value in the sub samples were multiplied with the total Volume in the diluted sample to obtain the Total count in the Sample. From the Total count in the sample and from the opening area of the net and the distance towed, the abundance of zooplankton per meter cube was calculated using the formula,  $Abundance = \frac{\text{Total Count in the Sample}}{\text{Distance towed} \times \text{Opening area}}$ . During the survey the zoo plankton were classified into Rotifera, Protozoa, Chordata, Mollusca, Annelida, Cnidaria, Crustacea and Chaetognatha. Additionally, Copepods were classified into three groups, Calanoida, Cyclopoida and Harpacticoida.

##### **5.14.1.2.2 Phytoplankton**

Analyses of the samples were done using a microscope using a Sedgewick rafter counting chamber. The chamber has a volume of approximately 1ml. The samples collected from the net were approximately 150 – 250ml in volume. For the phytoplankton count, the samples were transferred filtered through a 200µm sieve to remove large zooplankton for ease of counting. Thereafter the sample was transferred to a beaker, and diluted to approximately 500 – 900 ml and the volume recorded. The purpose of dilution is to reduce the number of plankton in the optical view of the microscope for ease of counting. Two sub-samples were counted from each sample. To calculate Total count in the sample the counts in the subsamples were averaged. Thereafter the average value in the sub samples was multiplied with the total Volume in the diluted sample to obtain the Total count in the Sample. From the Total count in the sample and from the opening area of the net and the distance towed, abundance of zooplankton per meter cube was calculated using the formula,  $Abundance = \frac{\text{Total Count in the Sample}}{\text{Distance towed} \times \text{Opening area}}$ .

#### **5.14.1.3 Limitations of the methodology**

The above method gives approximate estimates of abundances for each group/genera of plankton. Using a Sedgewick rafter to count zooplankton limits the subsample volume to 1ml thus, rare groups in plankton would likely not be observed in the counts. The method is reliable to estimate the total abundance of common groups of Zooplankton which are greater than 50µm in size and phytoplankton greater than 50 µm and less than 200µm.

#### **5.14.1.4 Plankton abundance**

##### **5.14.1.4.1 Zooplankton**

###### **5.14.1.4.1.1 Common Phyla**

Crustaceans were observed to be of the highest abundance amongst the zooplankton from all 7 sites. Additionally, the highest abundance of zoo plankton was observed from site 7 (PKT 7). The lowest abundance of zooplankton was observed from site 5. The table and figures below outline the variation in zooplankton abundance between the sites.

Table 4: Abundance of common phyla of zooplankton from sites PKT 1 to PKT 7.

Phyla	Abundance at sites (Individuals/m <sup>3</sup> )						
	PKT 1	PKT 2	PKT 3	PKT 4	PKT 5	PKT 6	PKT 7
Rotifera	174	760	1,270	293	195	814	1,519
Protozoa	260	2,170	1,563	1,172	781	1,628	868
Chordata	347	705	1465	977	391	746	217
Mollusca	87	163	391	NA	98	339	217
Annelida	174	54	98	NA	98	68	NA
Cnidaria	217	380	98	488	NA	NA	NA
Crustacea	3,212	7,378	16,113	9,277	1,465	6,782	21,267
Chaetognatha	43	109	488	98	NA	NA	217
Total Zooplankton	7,769	19,151	37,598	21,582	4,492	17,158	45,573

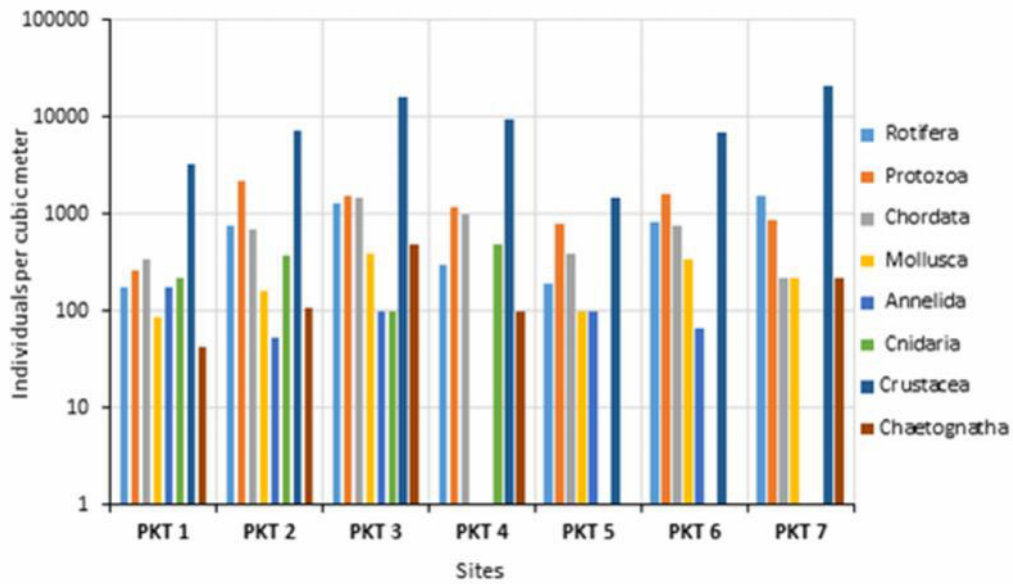


Figure 27: Abundance of common phylum of zooplankton from sites PKT 1 to PKT 7.

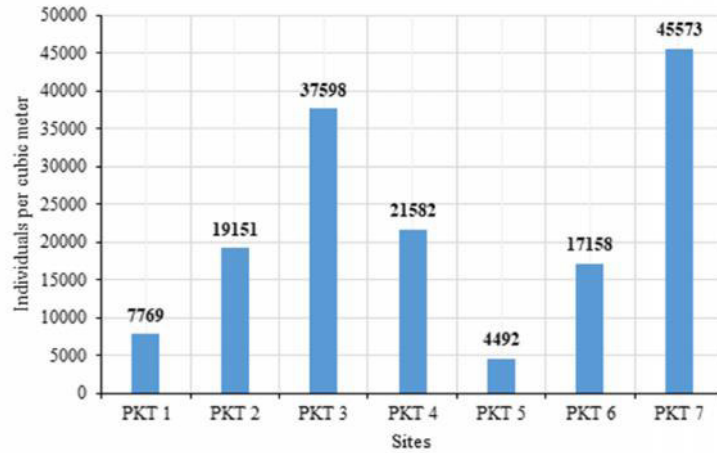


Figure 28: Total abundance of zooplankton from sites PKT 1 to PKT 7.

#### 5.14.1.4.1.2 Copepods

The dominating group of copepods observed in the sites were calanoids. The highest abundance of copepods were observed at site 7 and the lowest abundance of copepods at site 5. The table and figure below outlines the variation in copepod abundance between the sites.

Table 5: Abundance of copepods from sites PKT 1 to PKT 7.

Order	Abundance at Sites (Individuals/m <sup>3</sup> )						
	PKT 1	PKT 2	PKT 3	PKT 4	PKT 5	PKT 6	PKT 7
Calanoida	1693	2767	6543	3516	684	2509	11502
Cyclopoida	260	434	1367	391	195	543	1085
Harpacticoida	391	163	195	684	195	407	651

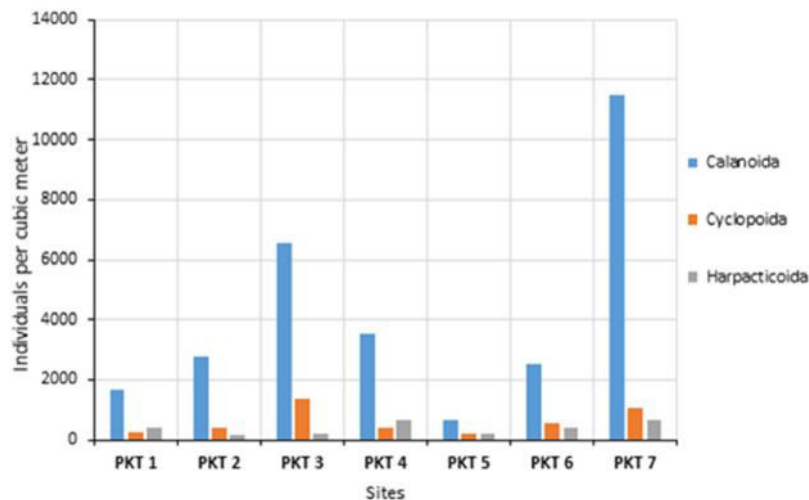


Figure 29: Abundance of copepods from sites PKT 1 to PKT 7.

#### 5.14.1.4.2 Phytoplankton

Diatoms were observed to be of the highest abundance, amongst the phytoplankton from all 7 sites. Additionally, the highest abundance of phytoplankton was observed from site 7 (PKT 7). Additionally,

the lowest abundance of phytoplankton were observed from site 5. The Figures below show the variation in phytoplankton abundance between the sites.

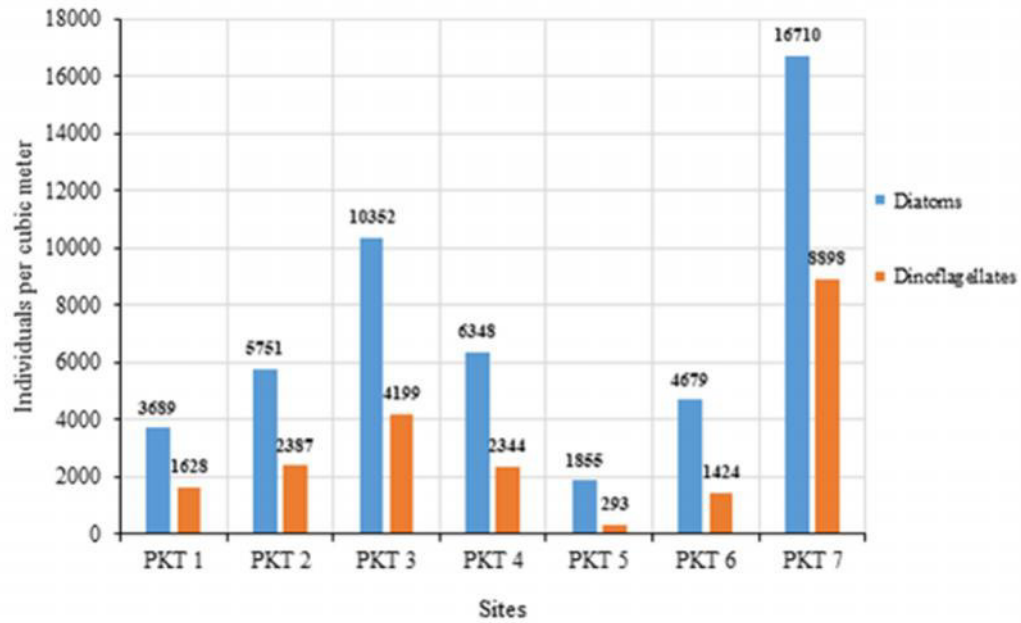


Figure 30: Abundance of diatoms and dinoflagellates from sites PKT 1 to PKT 7.

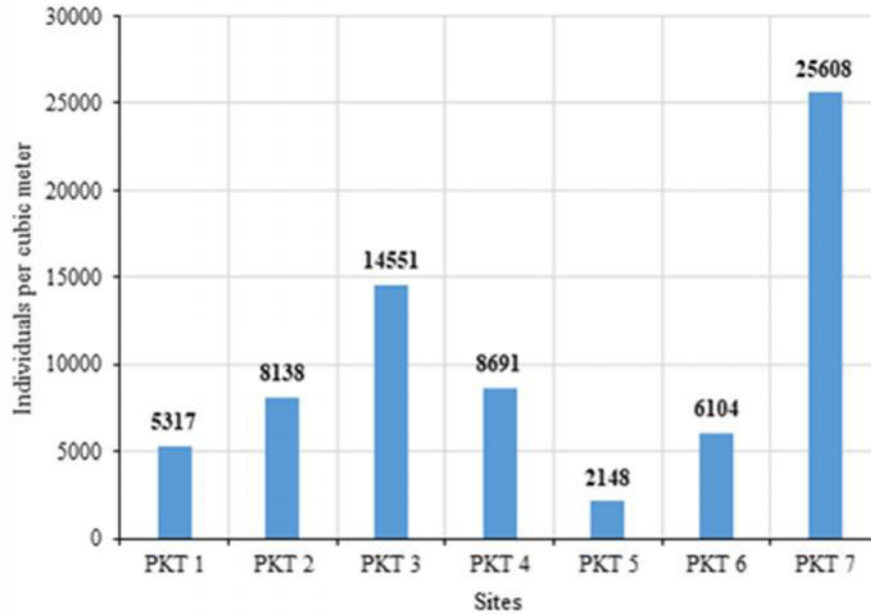


Figure 31: Total abundance of phytoplankton from sites PKT 1 to PKT 7.

---

## 6 Conclusion

The coral reef of Thilafushi has been under a lot of stress over the past two decades from the various industrial activities and developments that have occurred on this once barren reef. Over the years, the coral reef has undergone significant direct and indirect impacts resulting from the evolution of this artificial island that has been reclaimed initially from waste and later expanded in a more ecologically sound manner.

Surveys were undertaken in April 2018 and September 2019 to assess the coral reef and its health. The initial surveys were carried out in April 2018 which indicates that the highest coral cover was prevalent at a depth of 10 meters in site M2. This site is adjacent to the current waste dumping area. Therefore based on this results, there is the possibility that one can conclude that the leachate from land fill is not having a significant negative impacts on the reef at site M2 in terms of coral cover. On the overall, the reef around Thilafushi does not indicate a very healthy reef with average coral cover below 20% in most of the surveyed sites (based on the surveys done in April 2018).

A new set of surveys were conducted in three sites, M8, M9, M10, on 1<sup>st</sup> September 2019. This detail marine survey was carried out along a 500 m coastal stretch of house reef on southern site of Thilafushi between M9 and M10. The results indicate that very few (or none at all) marine species are found at a depth of less than 10 m along this stretch. The survey also revealed further that no significant marine life such as live corals, fishes or other pelagic organisms was found at greater depths from 10 m to 30 m along this stretch of house reef. The marine survey carried out in September 2019 found that the reef profiles at M8, M9 and M10 are very identical and at any of these sites, an outfall could be laid. Geographically, these three sites does not pose major challenges when it comes to laying an outfall pipe. There were no sensitive corals nor benthic cover recorded in any of these sites nor are any odd slope formations there.

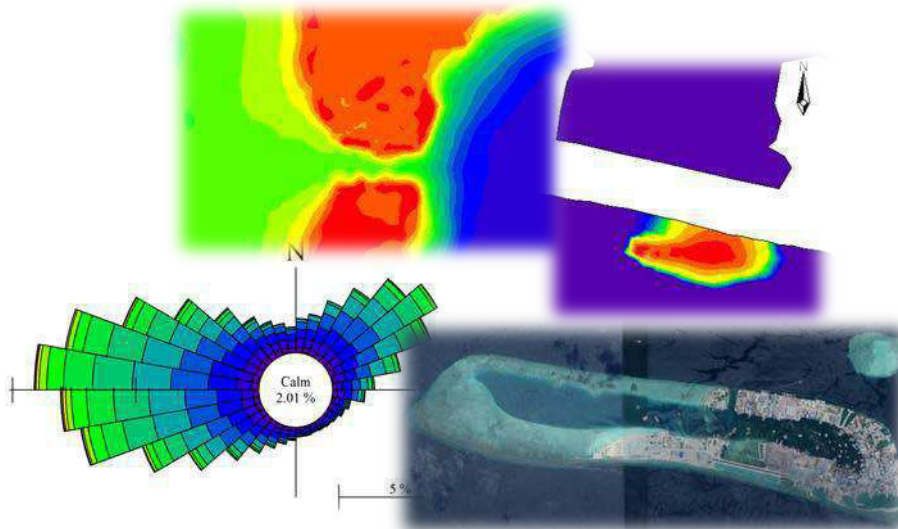
The reef slope at surveyed sites M8, M9 and M10 is characterized by a wall with the majority of the benthic composition being mainly rubble and silt. Along these sites, from a depth of approximately 20 meters and below, there is no live coral cover and the fish life is virtually none existent at the time of the survey on 1<sup>st</sup> September 2019. The southern side of Thilafushi is also exposed to a lot of sedimentation during south-west monsoon, which causes dispersion of sediments along a large area of the reef. This is the reason why the percentage of silt along M8, M9 and M10 were so high during the surveys undertaken in September 2019.

During the surveys in April 2018, one sea turtle was recorded. Sea turtles are very commonly observed throughout the Maldives due to their protected state. Their numbers have grown significantly since they were declared as a protected species in the 1980's. Since then, turtles are observed in a lot of reefs throughout the Maldives. Thilafushi being an artificial island does not possess the right coastal ecology for turtles to lay their eggs and no reports of turtle nests nor eggs have been reported to have been spotted from Thilafushi beaches. Hence, this single observation of a turtle can be confidently declared as an occasional occurrence.



**Water Solutions Pvt. Ltd.**

# **Effluent Dispersion Modelling at Thilafushi Island, Maldives**



## **Final Report**

October 2018



**Lanka Hydraulic Institute Ltd**

<b>Client</b> Water Solutions Pvt. Ltd		<b>Client's Representative</b> Mr. Ahmed Jameel			
<b>Project</b> Effluent Dispersion Modelling at Thilafushi Island, Maldives		<b>Project No.</b> 1808			
<b>Authors</b> Eng. M.S.L. Fernando Eng. (Ms) B.M.V. Basnayake		<b>Date</b> October 2018			
		<b>Approved by</b> Eng. J.K.P. Kurukulasuriya Eng. Dr. K. Raveenthiran			
Revision		By	Checked	Approved	Date
<b>Key words</b> Wind - Wave Transformation Hydrodynamic Thermal Dispersion		<b>Classification</b> <input type="checkbox"/> Open <input type="checkbox"/> Internal <input checked="" type="checkbox"/> Proprietary			
<b>Distribution</b> Water Solutions Pvt. Ltd 1 <sup>st</sup> Floor, Ma.Fas Eri, Ameenee Magu, Malé, Maldives,.		<b>No. of Copies:</b>			
		<b>Soft</b>		<b>Hard</b>	
		01		02	



## Lanka Hydraulic Institute Ltd

177, John Rodrigo Mawatha, Katubedda, Moratuwa, Sri Lanka.  
Tel. Nos. 2650409 / 2650471 / 2650472-3, Fax No. 2650470 - Email: lhi@lhi.lk

## TABLE OF CONTENTS

<b>1</b>	<b>INTRODUCTION .....</b>	<b>1</b>
1.1	Background.....	1
1.2	Objective of the Study.....	2
1.3	Basic Methodology of Study.....	2
<b>2</b>	<b>WIND DATA AND WAVE GENERATION .....</b>	<b>4</b>
2.1	Analysis of UKMO Wind Data .....	4
<b>3</b>	<b>WAVE CLIMATE MODELLING.....</b>	<b>7</b>
3.1	Introduction .....	7
3.2	Model Used – MIKE 21 SW Model System .....	7
3.3	Model Setup.....	8
3.4	Model Results .....	9
<b>4</b>	<b>HYDRODYNAMIC MODELLING.....</b>	<b>15</b>
4.1	MIKE 21 Hydrodynamic Model System .....	15
4.2	MIKE 21 HD Model Set Up .....	15
4.2.1	<i>Model Bathymetry.....</i>	<i>15</i>
4.2.2	<i>Simulation Period .....</i>	<i>16</i>
4.2.3	<i>Boundary Conditions .....</i>	<i>16</i>
4.2.4	<i>Wave and Wind Conditions .....</i>	<i>17</i>
4.3	MIKE 21 HD Model Calibration .....	18
4.4	MIKE 21 HD Results .....	18
<b>5</b>	<b>THERMAL DISPERSION MODELLING .....</b>	<b>20</b>
5.1	Introduction .....	20
5.2	Simulation Scenarios .....	20
5.3	Near Field Modelling .....	22
5.3.1	<i>Cormix Modelling System.....</i>	<i>22</i>
5.3.2	<i>Model Simulations .....</i>	<i>23</i>
5.3.3	<i>CORMIX Model Results .....</i>	<i>23</i>
5.3.4	<i>Discussion .....</i>	<i>25</i>
5.4	Far Field Modelling .....	25
5.4.1	<i>Input Data.....</i>	<i>26</i>
5.4.2	<i>Model Results and Discussion .....</i>	<i>28</i>
<b>6</b>	<b>SUMMARY AND CONCLUSION.....</b>	<b>30</b>

### ANNEX A: Current Speed Vector Plots

### ANNEX B: Heat Dissipation in Near Field (CORMIX)

### ANNEX C: Heat Dissipation in Far Field (MIKE 21 HD)



## LIST OF FIGURES

Figure 1.1: Location of Thilafushi Island .....	2
Figure 2.1: Wind Data Extracted Location .....	4
Figure 2.2: Annual Distribution of Wind .....	5
Figure 3.1: Wave Model Bathymetry - Regional .....	8
Figure 3.2: Wave Model Bathymetry - Local .....	9
Figure 3.3: Annual Wave Height Distribution at 300m Depth .....	13
Figure 3.4: Wave Height Distribution for South-West Monsoon at 300m Depth .....	13
Figure 3.5: Wave Height Distribution for North-East Monsoon at 300m Depth.....	14
Figure 4.1: Bathymetry for Regional Hydrodynamic Model .....	16
Figure 4.2: Bathymetry for Local Hydrodynamic Model.....	16
Figure 4.3: Predicted Tide in North Boundary .....	17
Figure 4.4: Predicted Tide in South Boundary .....	17
Figure 4.5: Calibration with Predicted Tide at Male.....	18
Figure 4.6: Current Extracted Points.....	19
Figure 5.1: Visualization of the Effluent Discharged from the Port and Rising to the Surface at Near-Field Region (3D View) .....	23
Figure 5.2: Visualization of the Effluent Discharged from the Port and Rising to the Surface in a Cross Flow at Near-Field Region. (Plan View) .....	24
Figure 5.3: Visualization of the Effluent Discharged from the Port Spreading at Near-Field Region. (Elevation) .....	24
Figure 5.4: Excess Concentration vs. Downstream Distance.....	25
Figure 5.5: Thermal Dispersion towards West at Scenario NE_N_07.....	29
Figure 5.6: Thermal Dispersion towards East at Scenario NE_N_07.....	29

## LIST OF TABLES

Table 2.1: Directional Distribution of Wind Statistics (Percentage Occurrence for Wind Speed vs Wind Direction) .....	6
Table 3.1: Annual Directional Distribution of Wave Height at 300m Depth (Percentage of Occurrence).....	10
Table 3.2: Annual Directional Distribution of Peak Wave Period at 300m Depth.....	10
Table 3.3: Directional Distribution of Wave Height for South-West Monsoon at 300m Depth (Percentage of Occurrence) .....	11
Table 3.4: Directional Distribution of Peak Wave Period for South-West Monsoon at 300m Depth.....	11
Table 3.5: Directional Distribution of Wave Height for North East Monsoon at 300m Depth (Percentage of Occurrence).....	12
Table 3.6: Directional Distribution of Peak Wave Period for North East Monsoon at 300m Depth.....	12
Table 4.1: Applied Wave/Wind Conditions for the Local Hydrodynamic Model .....	18
Table 4.2: Average Current Condition at Extracted Point.....	19
Table 5.1: Simulation Scenarios .....	21
Table 5.2: Input Excess Temperature for Far-Field Model .....	27

## **1 INTRODUCTION**

Water Solutions Pvt Ltd (WS) is currently assisting Ministry of Environment and Energy (MEE) to undertake an Environmental Impact Assessment (EIA) for Waste Management Project at Thilafushi Island, Maldives. As part of the project, an incinerator is proposed to burn waste material and seawater through an intake will be used to cool condenser. After cooling process, the hot seawater will be re-discharged through an outfall into the sea. As part of the EIA work, the dispersion behaviour of the discharged hot water need to assessed.

Water Solutions Pvt Ltd requested Lanka Hydraulic Institute Ltd (LHI) to submit a proposal for Effluent Dispersion Model study for the proposed cooling system of incinerator, and we, Lanka Hydraulic Institute Ltd (LHI), submitted the proposal in response to the requirements. After reviewing the proposal, LHI was awarded the contract to conduct the Effluent Dispersion Model study for the proposed cooling system of incinerator.

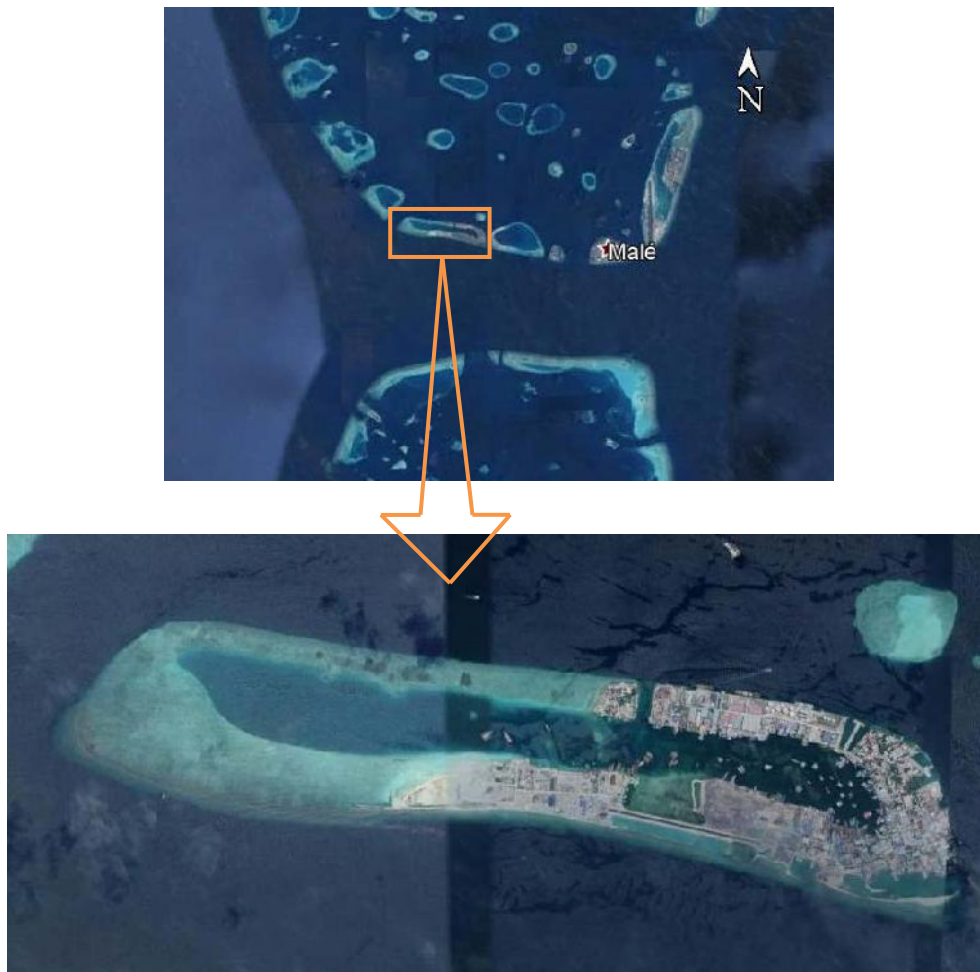
This report includes six chapters. Background of the project and basic methodology used in the study are given in Chapter 1. The details of collected wind data and analysis of it are given in Chapter 2. Wave transformation method and model usage for wave generation are discussed in detail in Chapter 3. In order to assess the water circulation, a set of hydrodynamic models was performed; those methods and results are discussed under Chapter 4. As the main part of study, thermal dispersion modelling system and discussion of its results are presented in Chapter 5. Finally the conclusions are given in Chapter 6.

### **1.1 Background**

The Thilafushi island is located in North Male Atoll, Maldives, and around 7km westwards to Male City (Figure 1.1). Presently, the island is used as the main waste dumping site in the country capital Male and its adjacent inhabited islands and the airport at Hulhule. The Government of the Maldives has identified solid waste disposal as a priority problem and decided to implement a solid waste management plan to minimize the environmental problem.

As a part of the project, an incinerator has been proposed to burn the waste. The cooling system of incinerator will run using sea water as coolant. The dispersion of hot water in marine environment is required to assess with respect to the coastal process of region.

This island is subjected to two monsoon period namely South-West and North-East; South West monsoon is considered as from May to November while North East as from December to April. Energy of swell waves approach from southern Indian ocean may reduce due to diffraction and other interaction of other atoll reefs, and mainly sea waves are affected to the island. Sea currents are developed around the island reef mainly wind, wave and tidal effect.



**Figure 1.1: Location of Thilafushi Island**

## 1.2 Objective of the Study

The discharge of effluent in the coastal area is a sensitive issue in the context of environmental conservation and therefore dispersion of the effluent requires proper assessment to ensure that nearshore coastal environment will not be subjected to pollution and health risk due to discharged effluent. For this purpose it is extremely essential to ensure that effluent constituent is diluted to acceptable levels within the receiving water in the immediate vicinity of discharge point. Secondly, the advection dispersion of the effluent should be favourable to the environment for every monsoon period.

The objective of this modelling task is to simulate the dynamic behaviour of hot water discharged through the outfall, and to assess the impacts on the surrounding areas of the outfalls, near-shore areas and beaches.

## 1.3 Basic Methodology of Study

Since the hot water dispersion is to be assessed for different monsoons and tidal conditions, at the first stage, wave conditions and tidal conditions require to be developed at site location. In

order to develop wave conditions for different monsoon periods at site location, long period wind data was used in a Wind-Wave Transformation Model (MIKE 21 SW). In order to find out current conditions, a Hydrodynamic Model (MIKE 21 HD) was utilised with giving wind/wave condition and tidal variation as input parameters. After that thermal dispersion model, CORMIX was used to find out initial dilution in near field and its results were further applied to the Hydrodynamic Model couple with thermal dispersion tool to assess the dilution in 2D plain.

Main activities of study are given below.

1. Obtain and analyze of UK Met Office (UKMO) wind data at site location.
2. Develop model bathymetries using Admiralty Chart Maps and measured data
3. Find out wave condition near the site using Wind-Wave Transformation Model (MIKE 21 SW)
4. Simulate a regional Hydrodynamic Model using known tidal boundaries in order to find out hydrodynamic conditions at local model boundaries.
5. Simulate local Hydrodynamic Model with applying wind, wave and tidal condition and find out current condition at site for different monsoons.
6. Apply current conditions obtained from Hydrodynamic Model in CORMIX model and find out initial dilution in near field.
7. Simulate again Hydrodynamic Model couple with thermal dispersion tool and applying CORMIX model results to assess the dilution in 2D plain.

## 2 WIND DATA AND WAVE GENERATION

The wind data was obtained based on the hind-cast data from Numerical Weather Prediction Atmospheric Global model of the UK Met Office (UKMO). The available nearest suitable data point (3.984 N, 73.477 E) which located in the South Male Atoll was selected with considering fetch length and open sea area which would be adopted in the wind wave model (Figure 2.1). Real time observational data from satellite wind radar, ship and buoy data were (and are) assimilated into the atmospheric model. This process strives to give the best possible rendition of the 'surface' wind field at analysis or run time, in order to give an optimum forecast. In effect, the atmospheric wind fields represent a hybrid of numerical and real data. It is the analysis time steps of these models of whatever resolution which go to make up the archive on which hind-casts are based.

Wind speed and wind direction for 30 years during January 1986 to June 2016 were utilized for the study. The data set contents 89,112 no of records with the interval of 3 hours. Analyses were carried out to assess the distribution of wind parameters and given in the Figure 2.2 and the Table 2.1.

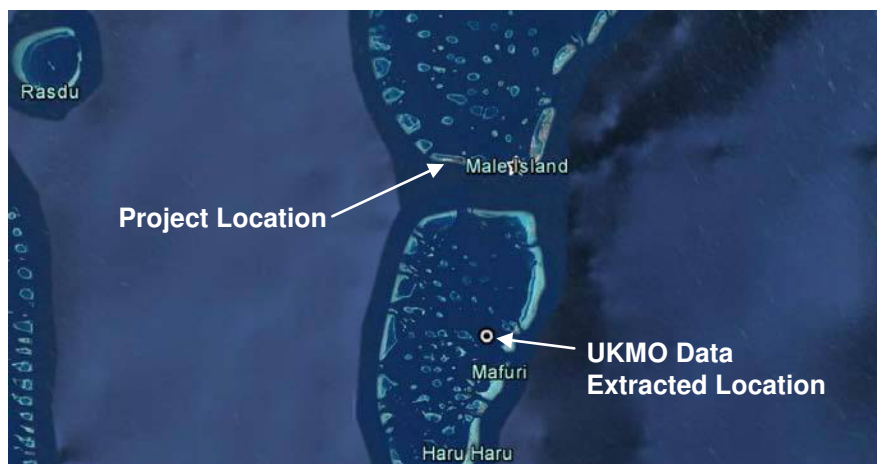


Figure 2.1: Wind Data Extracted Location

### 2.1 Analysis of UKMO Wind Data

Analysis of raw data before apply it in the model is an essential part in wind - wave transformation numerical modelling process to gain an idea about the wind climates of the region. Therefore analyses for UKMO data were carried out based on wind speed and direction.

Figure 2.2 illustrates clearly wind distribution pattern in 360° angle. The length of slices represents the percentage of occurrence while the colour code for the wind speeds. Furthermore, Table 2.1 shows the occurrence of wind by values in different directions and

various speeds. According to the analysis, two dominant wind directions can be observed; i.e. West and North-East. The wind reached from South- East quadrant is negligible.

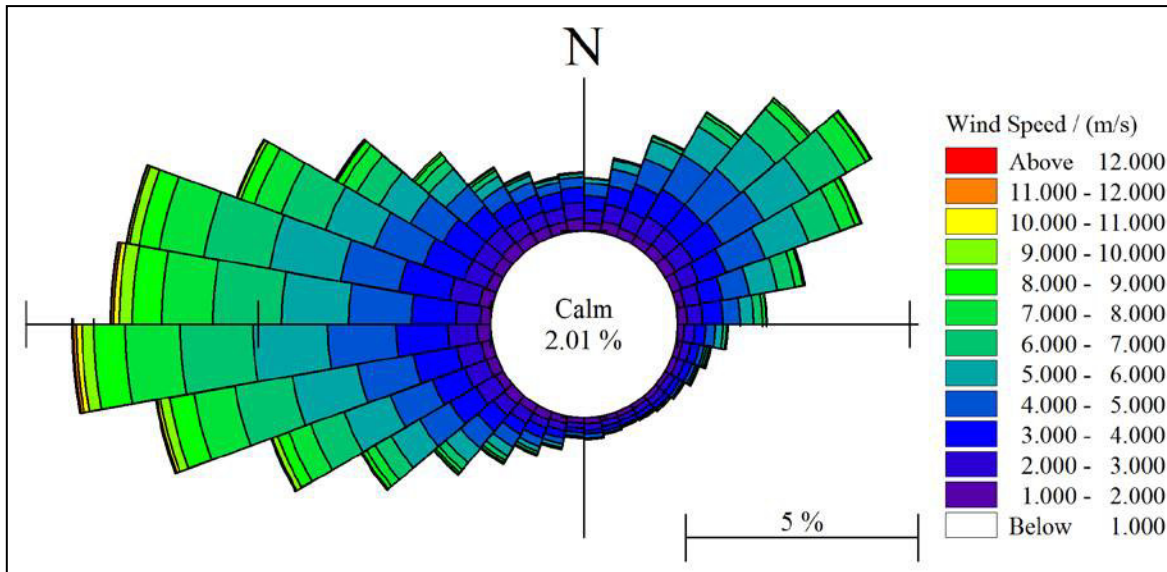


Figure 2.2: Annual Distribution of Wind

**Table 2.1: Directional Distribution of Wind Statistics (Percentage Occurrence for Wind Speed vs Wind Direction)**

Dir (Deg N) Speed (m/s)	0 -- 10	10 -- 20	20 -- 30	30 -- 40	40 -- 50	50 -- 60	60 -- 70	70 -- 80	80 -- 90	90 -- 100	100 -- 110	110 -- 120	120 -- 130	130 -- 140	140 -- 150	150 -- 160	160 -- 170	170 -- 180	180 -- 190	190 -- 200	200 -- 210	210 -- 220	220 -- 230	230 -- 240	240 -- 250	250 -- 260	260 -- 270	270 -- 280	280 -- 290	290 -- 300	300 -- 310	310 -- 320	320 -- 330	330 -- 340	340 -- 350	350 -- 360	Total
0 – 1	0.03	0.06	0.06	0.05	0.06	0.07	0.06	0.04	0.09	0.03	0.03	0.05	0.04	0.06	0.05	0.04	0.05	0.08	0.03	0.06	0.07	0.06	0.06	0.06	0.07	0.06	0.11	0.03	0.08	0.07	0.08	0.06	0.07	0.06	0.06	0.03	2.07
1 – 2	0.17	0.24	0.20	0.21	0.24	0.26	0.21	0.19	0.20	0.14	0.14	0.14	0.10	0.12	0.10	0.10	0.11	0.12	0.11	0.16	0.19	0.18	0.24	0.21	0.23	0.24	0.30	0.23	0.30	0.23	0.27	0.29	0.27	0.24	0.23	0.18	7.07
2 – 3	0.29	0.38	0.43	0.48	0.44	0.45	0.43	0.35	0.34	0.23	0.19	0.16	0.15	0.14	0.13	0.11	0.11	0.13	0.12	0.17	0.19	0.28	0.32	0.49	0.51	0.53	0.64	0.53	0.64	0.54	0.48	0.45	0.39	0.34	0.31	0.29	12.16
3 – 4	0.31	0.40	0.57	0.67	0.67	0.72	0.60	0.49	0.42	0.24	0.19	0.16	0.13	0.10	0.09	0.09	0.09	0.08	0.08	0.16	0.22	0.27	0.44	0.65	0.73	0.96	1.10	0.95	1.13	0.92	0.77	0.58	0.41	0.38	0.35	0.26	16.39
4 – 5	0.26	0.38	0.58	0.86	1.03	1.05	0.90	0.61	0.37	0.20	0.10	0.08	0.07	0.03	0.04	0.04	0.05	0.09	0.08	0.13	0.20	0.31	0.48	0.75	0.97	1.26	1.48	1.36	1.31	1.11	0.82	0.55	0.38	0.29	0.21	0.19	18.62
5 – 6	0.10	0.19	0.42	0.68	0.99	1.13	1.00	0.59	0.30	0.16	0.06	0.05	0.03	0.03	0.03	0.01	0.04	0.05	0.04	0.07	0.11	0.21	0.41	0.70	1.07	1.40	1.63	1.45	1.51	1.15	0.75	0.48	0.23	0.14	0.09	0.08	17.39
6 – 7	0.02	0.04	0.09	0.26	0.69	0.90	0.72	0.39	0.19	0.08	0.05	0.03	0.02	0.01	0.00	0.01	0.02	0.01	0.03	0.04	0.06	0.11	0.20	0.40	0.76	1.24	1.56	1.49	1.43	0.98	0.57	0.25	0.12	0.07	0.03	0.02	12.89
7 – 8	0.00	0.01	0.03	0.08	0.23	0.47	0.35	0.18	0.08	0.03	0.03	0.02	0.01	0.01				0.01	0.02	0.02	0.02	0.06	0.09	0.21	0.50	0.90	1.16	1.07	0.98	0.62	0.33	0.15	0.05	0.03	0.00	0.01	7.78
8 – 9		0.00	0.03	0.02	0.05	0.12	0.11	0.04	0.01	0.01	0.02	0.00							0.01	0.00	0.01	0.02	0.04	0.09	0.25	0.52	0.65	0.62	0.43	0.30	0.14	0.04	0.03	0.02		3.60	
9 – 10				0.02	0.04	0.05	0.03	0.00	0.00	0.00	0.00										0.00	0.01	0.01	0.02	0.12	0.21	0.24	0.28	0.21	0.08	0.04	0.01	0.00			1.39	
10 – 11						0.00	0.01																				0.03	0.06	0.13	0.12	0.06	0.02	0.00				0.47
11 – 12																										0.01	0.02	0.06	0.04	0.02	0.01	0.00	0.01				0.18
12 – 13																										0.01	0.01	0.04	0.01	0.01	0.01	0.00					0.09
13 – 14																									0.00		0.01	0.01									0.02
14 – 15																											0.00										0.00
15 – 16																												0.00									0.00
<b>Total</b>	<b>1.18</b>	<b>1.70</b>	<b>2.42</b>	<b>3.33</b>	<b>4.44</b>	<b>5.22</b>	<b>4.42</b>	<b>2.86</b>	<b>2.00</b>	<b>1.12</b>	<b>0.81</b>	<b>0.69</b>	<b>0.54</b>	<b>0.51</b>	<b>0.44</b>	<b>0.41</b>	<b>0.47</b>	<b>0.58</b>	<b>0.51</b>	<b>0.81</b>	<b>1.08</b>	<b>1.53</b>	<b>2.28</b>	<b>3.60</b>	<b>5.26</b>	<b>7.42</b>	<b>9.13</b>	<b>8.22</b>	<b>8.09</b>	<b>6.03</b>	<b>4.27</b>	<b>2.89</b>	<b>1.95</b>	<b>1.56</b>	<b>1.28</b>	<b>1.06</b>	<b>100</b>



### **3 WAVE CLIMATE MODELLING**

#### **3.1 Introduction**

Wave climate condition is one of main input parameter for the hydrodynamic model. Therefore it is required to develop wave climate conditions for different monsoons in order to set up the hydrodynamic model. The wave data is not available for the desired location on the sea fit for usage. Most of the time wave data measured point is far away from the project location and it has to be transformed to a desired location by a model. In this case, MIKE 21 numerical wave model was used for wind wave generation and transformation process. The objectives of the wave climate modelling of this scheme is establishing nearshore wave climate at the site.

#### **3.2 Model Used – MIKE 21 SW Model System**

MIKE 21 SW includes a new generation spectral wind-wave model based on unstructured mesh. The model simulates the growth, decay and transformation of wind-generated waves and swells in offshore and coastal areas. It includes two different formulations, namely, directional decoupled parametric formulation and fully spectral formulation. The directional decoupled parametric formulation is based on a parameterization of the wave action conservation equation. The parameterization is made in the frequency domain by introducing the zeroth and first moment of the wave action spectrum as dependent variables. The fully spectral formulation is based on the wave action conservation equation, where the directional-frequency wave action spectrum is the dependent variable.

The basic conservation equations are formulated in either Cartesian co-ordinates for small-scale applications or Polar Spherical co-ordinates for large-scale applications.

MIKE 21 SW includes the following physical phenomena:

- Wave growth by action of wind
- Non-linear wave-wave interaction
- Dissipation due to white capping
- Dissipation due to bottom friction
- Dissipation due to depth induced wave breaking
- Refraction and shoaling due to depth variation
- Wave-current interaction
- Effect of time varying water depth and flooding and drying

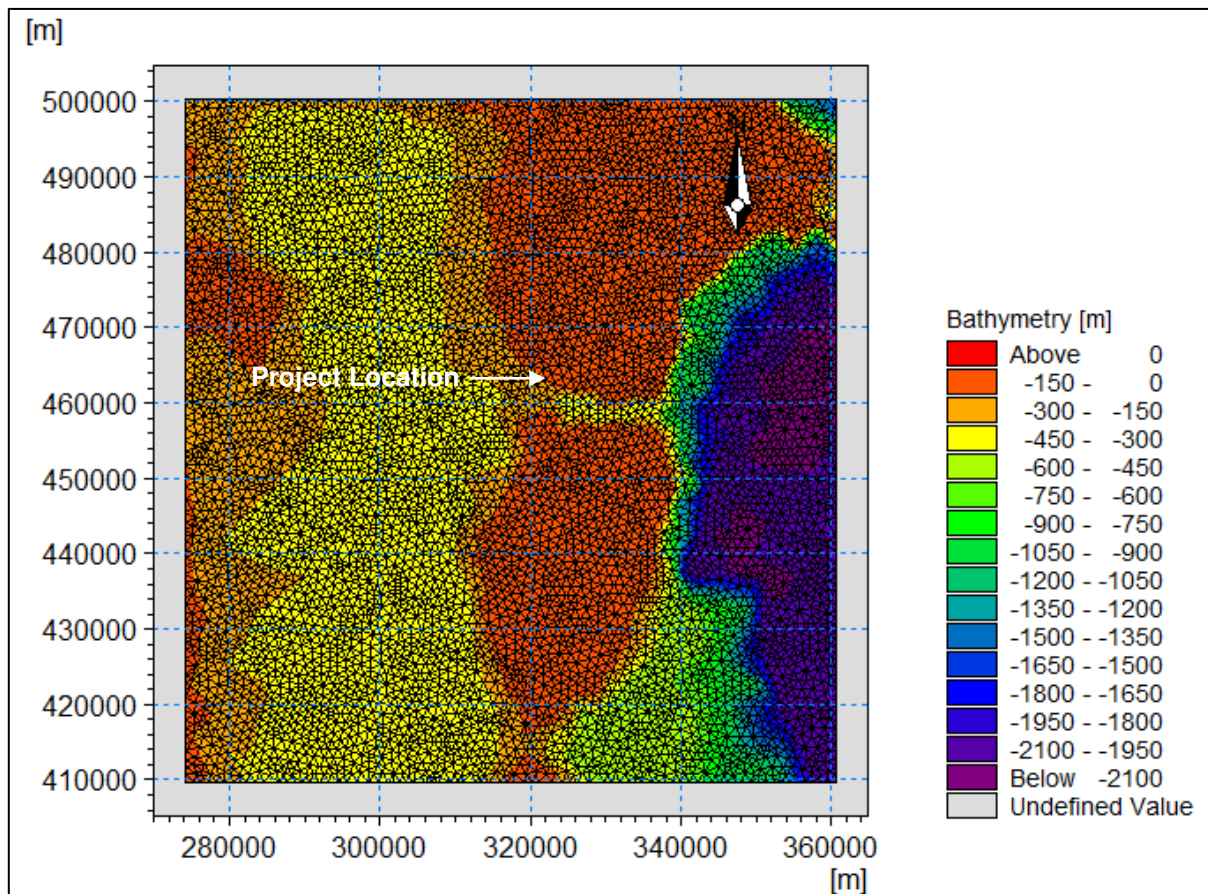
The discretization of the governing equation in geographical and spectral space is performed using cell-centered finite volume method. In the geographical domain, an unstructured mesh

technique is used. The time integration is performed using a fractional step approach where a multi-sequence explicit method is applied for the propagation of wave action.

### 3.3 Model Setup

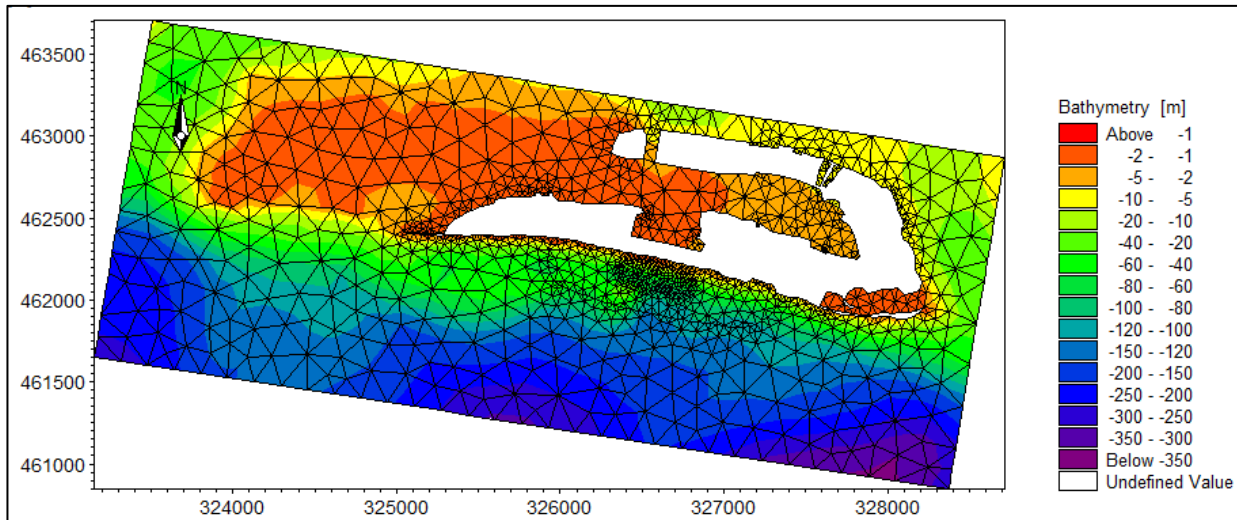
MIKE 21 SW model was used to generate waves and transfer them to the proposed site location base on UKMO wind data. All data set obtained from UKMO; i.e. 3 hour interval data from 1986 to 2016 were transferred to the site location.

The model was established by digitizing from the Admiralty charts No. 1013 & 3323, and near shore bathymetry data which were provided by WS. The preparation of model bathymetry was completed using flexible mesh as a requirement of SW model with reference to the Mean Sea Level. Figure 3.1 shows the regional model bathymetry of MIKE 21 SW model.



**Figure 3.1: Wave Model Bathymetry - Regional**

Additionally, a local model was also incorporated to improve the performance and accuracy of results. Then deep sea wind generated waves were transferred to 300m depth by regional model and then analysed wave data were further transferred to the site location by local model. The selected local model which the offshore boundary laid on around 300m depth is shown in Figure 3.2.



**Figure 3.2: Wave Model Bathymetry - Local**

### 3.4 Model Results

The wave analysis details of results obtained from the regional model at 300m depth are given below. The extracted results were analysed considering different seasons such as annual, South-West and North-East monsoon periods. South West monsoon was considered as from May to November while North East as from December to April. Tables 3.1 to 3.6 indicate the percentage of occurrence of waves, and their average peak wave period corresponding to the wave height and direction while Figures 3.3 to 3.5 graphically illustrate the wave height distribution patten in 360° angle.

**Table 3.1: Annual Directional Distribution of Wave Height at 300m Depth (Percentage of Occurrence)**

Dir (Deg.N) Hs (m)	0 -- 10	10 -- 20	20 -- 30	30 -- 40	40 -- 50	50 -- 60	60 -- 70	70 -- 80	80 -- 90	90 -- 100	100 -- 110	110 -- 120	120 -- 130	130 -- 140	140 -- 150	150 -- 160	160 -- 170	170 -- 180	180 -- 190	190 -- 200	200 -- 210	210 -- 220	220 -- 230	230 -- 240	240 -- 250	250 -- 260	260 -- 270	270 -- 280	280 -- 290	290 -- 300	300 -- 310	310 -- 320	320 -- 330	330 -- 340	340 -- 350	350 -- 360	Total	
0 -- 0.2	0.71	0.88	0.99	1.17	1.36	1.30	1.30	1.05	0.80	0.67	0.47	0.41	0.32	0.33	0.28	0.26	0.25	0.28	0.29	0.36	0.43	0.53	0.62	0.78	0.89	1.01	1.10	1.31	1.20	1.14	1.11	0.98	0.83	0.81	0.73	0.69	27.64	
0.2 -- 0.4	0.19	0.32	0.49	0.99	1.73	2.78	3.30	2.53	1.47	0.76	0.43	0.27	0.23	0.17	0.15	0.13	0.14	0.13	0.15	0.18	0.25	0.37	0.58	1.03	1.52	2.41	2.93	2.76	2.04	1.27	0.72	0.46	0.28	0.19	0.16	0.16	33.67	
0.4 -- 0.6		0.00	0.01	0.02	0.09	0.44	1.06	0.90	0.41	0.18	0.11	0.07	0.03	0.02	0.01	0.01	0.01	0.02	0.02	0.05	0.12	0.22	0.59	1.59	3.40	4.53	4.29	2.76	1.31	0.41	0.14	0.05	0.01	0.01			22.88	
0.6 -- 0.8			0.00	0.00	0.01	0.01	0.03	0.03	0.01	0.00	0.01	0.00	0.00	0.00	0.00			0.00	0.00	0.00	0.01	0.05	0.15	0.52	2.17	3.58	2.84	1.15	0.30	0.04	0.00	0.00	0.00	0.00			10.95	
0.8 -- 1			0.00	0.00	0.00		0.00	0.00	0.00	0.00			0.00		0.00	0.00						0.00	0.03	0.13	0.81	1.56	0.97	0.19	0.03	0.00		0.00		0.00			3.75	
1 -- 1.2			0.00	0.00	0.00	0.00										0.00			0.00				0.00	0.01	0.18	0.42	0.19	0.03	0.00		0.00		0.00				0.85	
1.2 -- 1.4		0.00	0.00		0.00	0.00										0.00	0.00	0.00								0.02	0.11	0.04						0.00	0.00			0.17
1.4 -- 1.6					0.00			0.00	0.00																	0.00	0.01	0.00			0.00	0.00	0.00	0.00				0.03
1.6 -- 1.8				0.00		0.00	0.00		0.00						0.00											0.00	0.00	0.00			0.00	0.00		0.00				0.01
1.8 -- 2					0.00			0.00													0.00		0.00															0.01
2 -- 2.2					0.00	0.00		0.00	0.00										0.00	0.00											0.00			0.00				0.01
Above 2.2		0.00	0.00		0.00	0.00	0.00	0.00	0.00	0.00		0.00	0.00				0.00				0.00		0.00	0.00							0.00		0.00				0.02	
Total	0.90	1.20	1.49	2.19	3.19	4.53	5.69	4.52	2.68	1.61	1.02	0.74	0.58	0.52	0.44	0.39	0.41	0.43	0.46	0.59	0.82	1.15	1.97	4.06	8.98	13.64	12.36	8.20	4.87	2.85	1.97	1.49	1.12	1.02	0.90	0.85	100.00	

**Table 3.2: Annual Directional Distribution of Peak Wave Period at 300m Depth**

Dir (Deg.N) Hs (m)	0 -- 10	10 -- 20	20 -- 30	30 -- 40	40 -- 50	50 -- 60	60 -- 70	70 -- 80	80 -- 90	90 -- 100	100 -- 110	110 -- 120	120 -- 130	130 -- 140	140 -- 150	150 -- 160	160 -- 170	170 -- 180	180 -- 190	190 -- 200	200 -- 210	210 -- 220	220 -- 230	230 -- 240	240 -- 250	250 -- 260	260 -- 270	270 -- 280	280 -- 290	290 -- 300	300 -- 310	310 -- 320	320 -- 330	330 -- 340	340 -- 350	350 -- 360	Average	
0 -- 0.2	1.8	1.9	1.9	1.9	2.0	2.0	2.0	2.0	1.9	2.0	1.9	1.8	1.9	1.9	1.8	1.8	2.1	1.9	1.9	1.8	1.7	1.7	1.8	1.8	1.8	1.8	1.9	1.9	1.9	1.9	1.8	1.8	1.8	1.8	1.7	1.7	1.7	1.9
0.2 -- 0.4	2.3	2.5	2.5	2.5	2.5	2.6	2.7	2.7	2.7	2.7	2.7	2.8	2.8	2.8	2.8	3.0	3.1	3.2	3.0	3.0	3.0	3.0	3.0	3.0	3.0	3.0	3.0	3.0	2.9	2.8	2.7	2.6	2.5	2.4	2.4	2.4	2.8	
0.4 -- 0.6		9.1	7.8	7.0	3.2	3.0	3.1	3.1	3.1	3.2	3.4	3.5	3.3	4.3	7.6	8.5	4.8	8.8	3.6	3.6	3.7	3.8	3.8	3.8	3.8	3.7	3.7	3.6	3.5	3.3	3.4	3.2	3.6	4.9			3.6	
0.6 -- 0.8			11.6	10.9	12.4	8.7	7.3	5.3	6.4	5.2	3.5	6.5	13.3	11.5	13.4			19.9	4.0	9.7	4.2	4.2	4.3	4.3	4.2	4.2	4.1	4.0	3.9	3.7	8.9	14.7	13.5	12.9			4.2	
0.8 -- 1			13.0	14.1	14.7		10.7	12.2	11.0	12.7			11.8	19.4	7.9	7.0							4.7	5.3	4.6	4.6	4.5	4.4	4.3	4.2	4.1		14.2		12.4			4.5
1 -- 1.2			12.3	10.9	15.9	12.2									12.1			12.3					5.0	5.0	4.9	4.8	4.7	4.6	10.9		13.0		16.3				5.1	
1.2 -- 1.4		13.5	12.7		16.6	13.8									13.1	9.8	14.4								5.2	5.1	5.0						14.4	14.0			6.0	
1.4 -- 1.6					16.7			14.1	12.8																5.5	5.3	5.2				11.8	14.3	18.8	18.0			9.2	
1.6 -- 1.8				13.0		14.2	11.2		14.5						21.2											5.4	5.4	11.6		13.6	16.0		15.8				13.4	
1.8 -- 2					15.6			13.0													12.7		18.8														14.8	
2 -- 2.2					12.8	13.4		14.7	16.9										10.9	12.2											19.8			14.2			15.3	
Above 2.2		17.7	15.1		10.1	12.8	16.4	12.8	15.6	19.6		16.8	13.1			20.9					16.4		15.3	15.4							16.2		15.3				16.3	
Average	1.9	2.1	2.3	2.2	2.4	2.5	2.6	2.6	2.6	2.5	2.4	2.3	2.4	2.3	2.5	2.4	2.5	2.5	2.3	2.3	2.4	2.6	3.0	3.3	3.7	3.7	3.5	3.2	2.9	2.5	2.3	2.1	2.0	2.0	1.9	1.8	3.0	

**Table 3.3: Directional Distribution of Wave Height for South-West Monsoon at 300m Depth (Percentage of Occurrence)**

Dir (Deg.N) Hs (m)	0 -- 10	10 -- 20	20 -- 30	30 -- 40	40 -- 50	50 -- 60	60 -- 70	70 -- 80	80 -- 90	90 -- 100	100 -- 110	110 -- 120	120 -- 130	130 -- 140	140 -- 150	150 -- 160	160 -- 170	170 -- 180	180 -- 190	190 -- 200	200 -- 210	210 -- 220	220 -- 230	230 -- 240	240 -- 250	250 -- 260	260 -- 270	270 -- 280	280 -- 290	290 -- 300	300 -- 310	310 -- 320	320 -- 330	330 -- 340	340 -- 350	350 -- 360	Total
0 -- 0.2	0.09	0.09	0.08	0.06	0.07	0.03	0.04	0.05	0.07	0.09	0.08	0.08	0.15	0.21	0.24	0.20	0.25	0.31	0.38	0.49	0.60	0.74	0.84	1.13	1.18	1.17	1.19	1.32	1.04	0.79	0.68	0.45	0.30	0.21	0.19	0.10	15.00
0.2 -- 0.4	0.00		0.01	0.01	0.01	0.01	0.01	0.01	0.01	0.01	0.01	0.01	0.03	0.08	0.13	0.15	0.21	0.22	0.27	0.35	0.45	0.65	1.10	1.88	2.55	3.87	4.13	3.52	2.08	1.11	0.57	0.27	0.13	0.04	0.03	0.02	23.96
0.4 -- 0.6			0.01	0.00	0.00		0.01	0.00		0.00	0.00	0.00		0.01	0.01	0.01	0.02	0.03	0.05	0.10	0.23	0.37	1.07	3.00	6.42	8.04	7.35	4.46	2.04	0.66	0.24	0.06	0.00	0.00			34.20
0.6 -- 0.8			0.01	0.01	0.01	0.01								0.00	0.00				0.00	0.00	0.02	0.08	0.31	1.03	4.22	6.25	4.86	1.94	0.57	0.09	0.01					19.41	
0.8 -- 1				0.00	0.00	0.00	0.01						0.00			0.00						0.00	0.04	0.22	1.24	2.47	1.63	0.33	0.07	0.01						6.03	
1 -- 1.2			0.01	0.00	0.00	0.00												0.00					0.00	0.02	0.19	0.49	0.33	0.05	0.01				0.00			1.10	
1.2 -- 1.4			0.00		0.00											0.00		0.01								0.01	0.11	0.07									0.21
1.4 -- 1.6											0.01															0.01	0.02	0.01				0.00	0.00				0.05
1.6 -- 1.8				0.00			0.00		0.00																		0.00	0.00	0.00								0.02
1.8 -- 2					0.01			0.00																													0.01
2 -- 2.2						0.00			0.00										0.00	0.00																	0.01
Above 2.2			0.00		0.00	0.00			0.00														0.00														0.01
<b>Total</b>	0.09	0.09	0.12	0.08	0.10	0.05	0.07	0.07	0.09	0.11	0.10	0.10	0.18	0.30	0.37	0.37	0.49	0.58	0.70	0.95	1.30	1.85	3.36	7.28	15.82	22.44	19.56	11.61	5.80	2.65	1.49	0.79	0.44	0.25	0.22	0.12	100.00

**Table 3.4: Directional Distribution of Peak Wave Period for South-West Monsoon at 300m Depth**

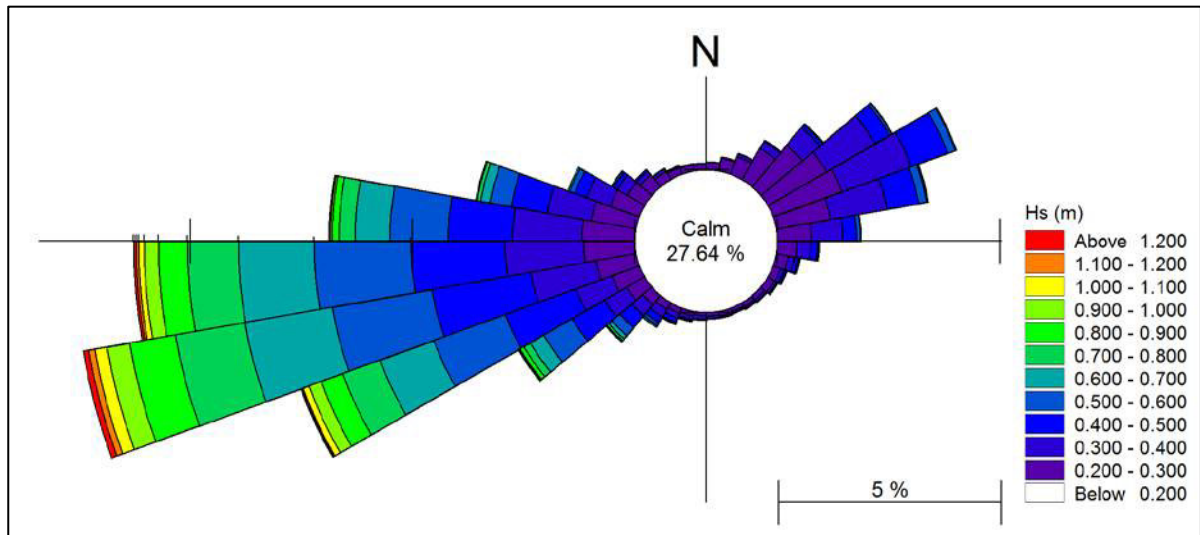
Dir (Deg.N) Hs (m)	0 -- 10	10 -- 20	20 -- 30	30 -- 40	40 -- 50	50 -- 60	60 -- 70	70 -- 80	80 -- 90	90 -- 100	100 -- 110	110 -- 120	120 -- 130	130 -- 140	140 -- 150	150 -- 160	160 -- 170	170 -- 180	180 -- 190	190 -- 200	200 -- 210	210 -- 220	220 -- 230	230 -- 240	240 -- 250	250 -- 260	260 -- 270	270 -- 280	280 -- 290	290 -- 300	300 -- 310	310 -- 320	320 -- 330	330 -- 340	340 -- 350	350 -- 360	Average
0 -- 0.2	1.4	2.5	4.8	2.1	2.4	2.4	1.3	1.4	2.7	1.6	1.8	1.7	2.1	1.9	1.9	1.8	1.8	1.9	1.8	1.8	1.8	1.8	1.8	1.8	1.9	1.9	1.9	1.9	1.9	1.9	1.8	1.8	1.7	2.0	1.6	1.6	1.9
0.2 -- 0.4	2.2		5.3	4.1	6.1	8.6	3.7	10.3	11.5	7.9	2.5	3.7	2.7	2.7	2.8	3.0	2.9	3.1	3.1	3.0	3.0	3.0	3.0	3.0	3.0	3.0	3.0	2.9	2.9	2.8	2.7	2.5	2.4	2.4	2.4	3.0	
0.4 -- 0.6			11.7	9.3	10.1		12.2	7.9		7.9	15.7	8.1		6.8	3.3	5.9	3.8	3.5	3.5	3.7	3.8	3.8	3.8	3.8	3.8	3.8	3.7	3.7	3.6	3.5	3.4	3.2	3.1	3.1	13.0		3.7
0.6 -- 0.8			11.5	9.0	9.9		12.7							11.5	17.2				4.0	4.2	4.2	4.2	4.3	4.2	4.2	4.2	4.1	4.0	3.9	3.7	3.6					4.2	
0.8 -- 1				14.1	16.1		10.7	12.2								7.9							4.6	4.7	4.6	4.6	4.5	4.4	4.3	4.2	4.1						4.5
1 -- 1.2			12.3	10.3	13.1	13.0													12.3				4.9	5.0	4.9	4.8	4.7	4.6	10.9				18.7			5.1	
1.2 -- 1.4			12.7		16.6											13.1		13.5								5.2	5.1	5.0								5.9	
1.4 -- 1.6											14.3															5.5	5.3	5.2			11.8	13.6				8.6	
1.6 -- 1.8				13.0			11.2		14.5																		5.4	5.4	11.6							11.1	
1.8 -- 2					15.6			13.0																												14.7	
2 -- 2.2						13.4			13.1										10.9	12.2																12.6	
Above 2.2			15.8		10.1	12.8			20.0														15.3													11.5	
<b>Average</b>	1.5	2.5	6.8	4.0	6.2	7.1	6.0	4.4	5.8	2.6	3.5	2.0	2.4	2.3	2.3	2.6	2.4	2.5	2.5	2.5	2.6	2.7	3.1	3.3	3.7	3.7	3.6	3.3	3.0	2.7	2.4	2.1	2.0	2.2	1.7	1.7	3.4

**Table 3.5: Directional Distribution of Wave Height for North East Monsoon at 300m Depth (Percentage of Occurrence)**

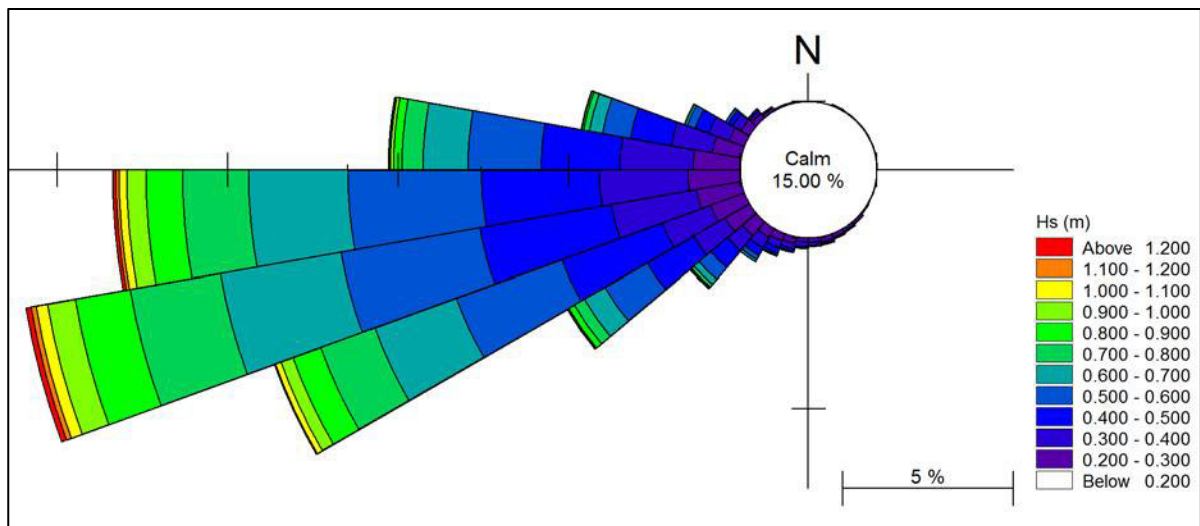
Dir (Deg.N) \ Hs (m)	0 -- 10	10 -- 20	20 -- 30	30 -- 40	40 -- 50	50 -- 60	60 -- 70	70 -- 80	80 -- 90	90 -- 100	100 -- 110	110 -- 120	120 -- 130	130 -- 140	140 -- 150	150 -- 160	160 -- 170	170 -- 180	180 -- 190	190 -- 200	200 -- 210	210 -- 220	220 -- 230	230 -- 240	240 -- 250	250 -- 260	260 -- 270	270 -- 280	280 -- 290	290 -- 300	300 -- 310	310 -- 320	320 -- 330	330 -- 340	340 -- 350	350 -- 360	Total	
0 -- 0.2	1.31	1.73	2.15	2.52	2.85	2.81	2.76	2.01	1.42	1.01	0.65	0.53	0.31	0.28	0.18	0.12	0.16	0.08	0.07	0.07	0.15	0.12	0.07	0.13	0.16	0.20	0.27	0.31	0.33	0.48	0.70	0.87	0.85	0.98	1.04	1.18	30.86	
0.2 -- 0.4	0.62	0.98	1.59	3.31	5.87	9.57	11.03	7.95	4.07	1.84	0.87	0.60	0.33	0.22	0.12	0.07	0.04		0.02	0.01	0.02	0.03	0.02	0.07	0.11	0.20	0.31	0.49	0.55	0.51	0.45	0.53	0.43	0.42	0.42	0.46	54.14	
0.4 -- 0.6		0.01	0.01	0.07	0.34	1.67	4.06	3.32	1.42	0.62	0.33	0.20	0.05	0.01	0.03	0.01			0.00		0.01	0.02	0.00	0.04	0.20	0.21	0.30	0.17	0.13	0.10	0.07	0.03	0.02	0.01		0.01	13.49	
0.6 -- 0.8					0.01	0.01	0.10	0.11	0.01	0.01	0.02	0.00	0.00									0.01	0.00		0.11	0.33	0.18	0.03	0.00		0.00		0.00				0.95	
0.8 -- 1																							0.02	0.02	0.16	0.18	0.02							0.00			0.41	
1 -- 1.2				0.00											0.00											0.01	0.06	0.01			0.00						0.10	
1.2 -- 1.4		0.00																								0.00											0.01	
1.4 -- 1.6																																	0.00	0.00				0.01
1.6 -- 1.8															0.00																0.00	0.00					0.01	
1.8 -- 2																																						
2 -- 2.2																																			0.00			0.00
Above 2.2								0.00	0.00	0.00							0.00																					0.02
Total	1.94	2.73	3.75	5.89	9.08	14.06	17.95	13.40	6.93	3.48	1.87	1.33	0.69	0.52	0.34	0.20	0.20	0.08	0.10	0.09	0.19	0.17	0.13	0.26	0.79	1.13	1.08	1.00	1.02	1.09	1.23	1.44	1.31	1.43	1.45	1.64	100.00	

**Table 3.6: Directional Distribution of Peak Wave Period for North East Monsoon at 300m Depth**

Dir (Deg.N) \ Hs (m)	0 -- 10	10 -- 20	20 -- 30	30 -- 40	40 -- 50	50 -- 60	60 -- 70	70 -- 80	80 -- 90	90 -- 100	100 -- 110	110 -- 120	120 -- 130	130 -- 140	140 -- 150	150 -- 160	160 -- 170	170 -- 180	180 -- 190	190 -- 200	200 -- 210	210 -- 220	220 -- 230	230 -- 240	240 -- 250	250 -- 260	260 -- 270	270 -- 280	280 -- 290	290 -- 300	300 -- 310	310 -- 320	320 -- 330	330 -- 340	340 -- 350	350 -- 360	Average	
0 -- 0.2	1.8	1.9	1.9	1.9	2.0	2.0	2.0	2.0	1.9	2.1	1.8	1.8	1.8	1.8	2.2	1.8	2.4	2.1	2.8	1.9	2.0	1.5	1.9	1.9	1.6	1.8	1.7	1.8	1.9	1.9	1.9	1.8	1.7	1.8	1.8	1.8	1.8	1.9
0.2 -- 0.4	2.3	2.4	2.4	2.4	2.5	2.6	2.7	2.7	2.7	2.7	2.7	2.7	2.9	2.8	2.8	2.9	3.1		2.5	2.6	2.9	2.8	3.1	2.8	3.0	2.9	3.0	2.9	2.9	2.8	2.7	2.6	2.5	2.4	2.4	2.3	2.6	
0.4 -- 0.6		6.5	5.0	2.9	3.0	3.0	3.0	3.1	3.1	3.1	3.2	3.2	3.3	3.2	7.4	7.2			7.6		3.8	3.9	3.7	3.7	3.8	3.7	3.6	3.5	3.4	3.3	3.7	3.1	3.0	2.9		2.8	3.1	
0.6 -- 0.8					3.2	3.3	3.4	3.6	3.4	8.7	3.5	3.6	14.2									4.3	4.5		4.3	4.2	4.1	3.9	3.8		10.0		13.5				4.1	
0.8 -- 1																							6.9	4.8	4.6	4.5	4.4								12.4		4.8	
1 -- 1.2				14.5												12.1										4.9	4.9	4.9			13.0							6.1
1.2 -- 1.4		13.5																																			9.3	
1.4 -- 1.6																																		18.8	18.0		18.4	
1.6 -- 1.8															21.2																13.6	13.3					16.0	
1.8 -- 2																																			14.2		14.2	
2 -- 2.2																																						
2.2 -- 2.4								12.8	11.1	19.6							20.9																					17.5
Average	2.0	2.1	2.2	2.2	2.4	2.5	2.6	2.7	2.6	2.7	2.5	2.5	2.5	2.2	3.1	2.8	3.0	2.1	3.0	2.0	2.2	2.1	3.2	2.7	3.6	3.5	3.1	2.7	2.6	2.4	2.4	2.2	2.1	2.1	1.9	1.9	2.5	



**Figure 3.3: Annual Wave Height Distribution at 300m Depth**



**Figure 3.4: Wave Height Distribution for South-West Monsoon at 300m Depth**

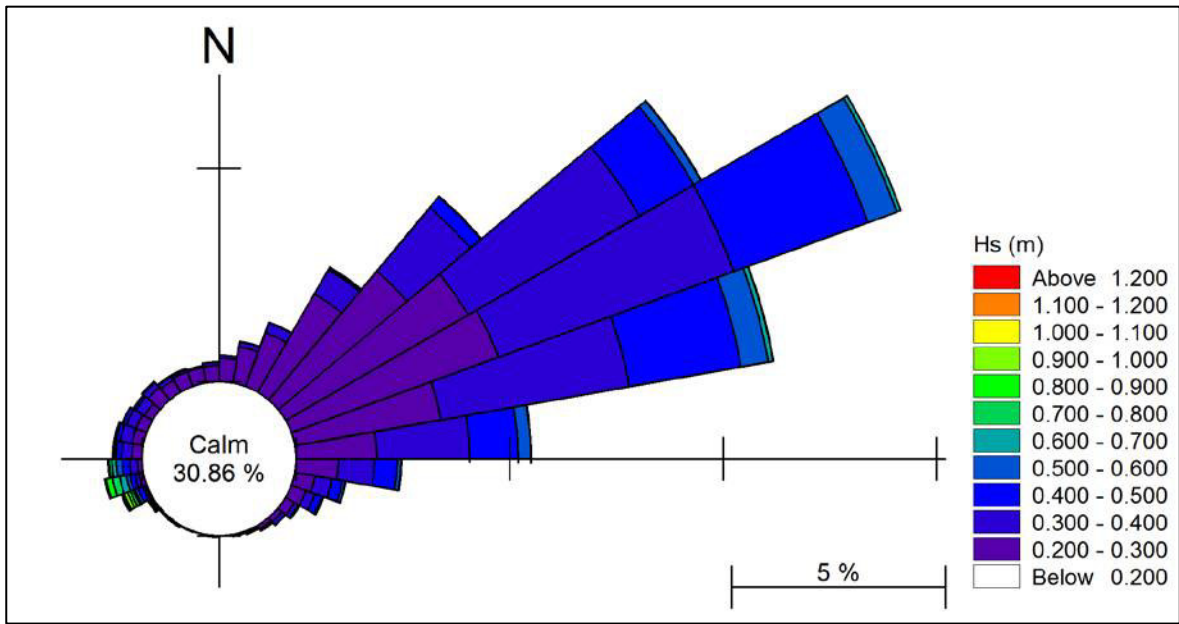


Figure 3.5: Wave Height Distribution for North-East Monsoon at 300m Depth



## **4 HYDRODYNAMIC MODELLING**

In order to compute water circulation with effect of tidal flow, wave and wind in and around the study area, a hydrodynamic model required to be carried out. Hence, the numerical model, MIKE 21 HD was used in this process.

### **4.1 MIKE 21 Hydrodynamic Model System**

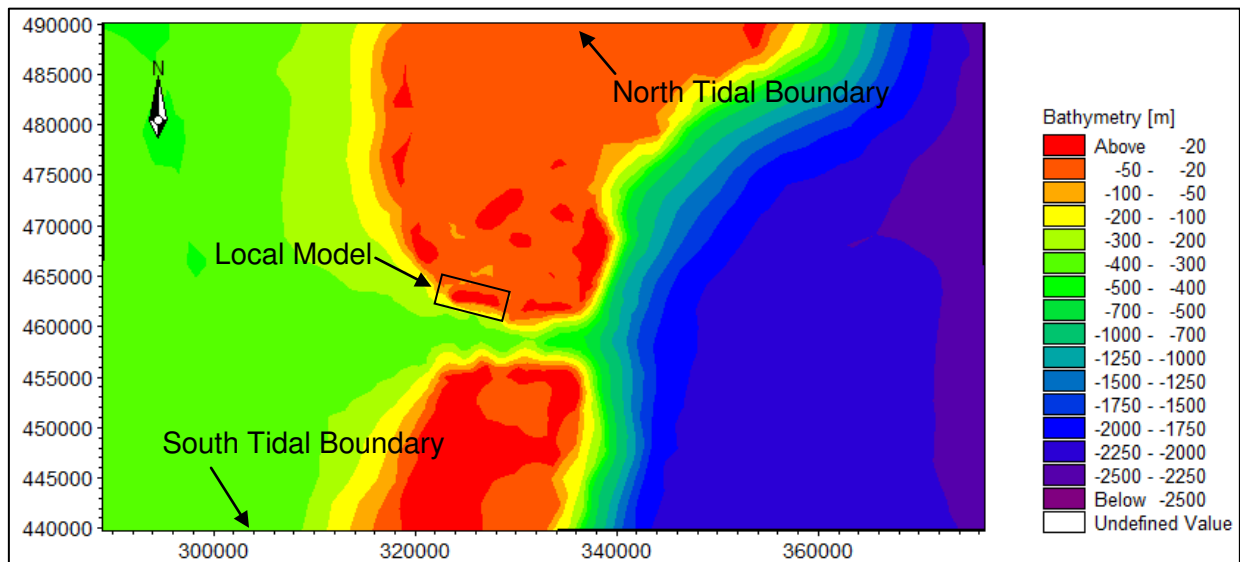
MIKE 21 HD (Flexible Mesh) model developed by Danish Hydraulic Institute was used for the simulation. It is a modelling system for 2D free-surface flows and applicable to the simulation of hydraulic and environmental phenomena in lakes, rivers, estuaries, bays, coastal areas and seas in response to a variety of forcing functions including tide, wind, wave and river flow. The HD module allows you to specify a variety of hydrographic boundary conditions, initial conditions, bed resistance and wind forcing. It also allows you to include different types of sources and sinks as well as a number of different structures. It provides the hydrodynamic basis for the computations performed in the environmental hydraulics and sediment transport modules.

### **4.2 MIKE 21 HD Model Set Up**

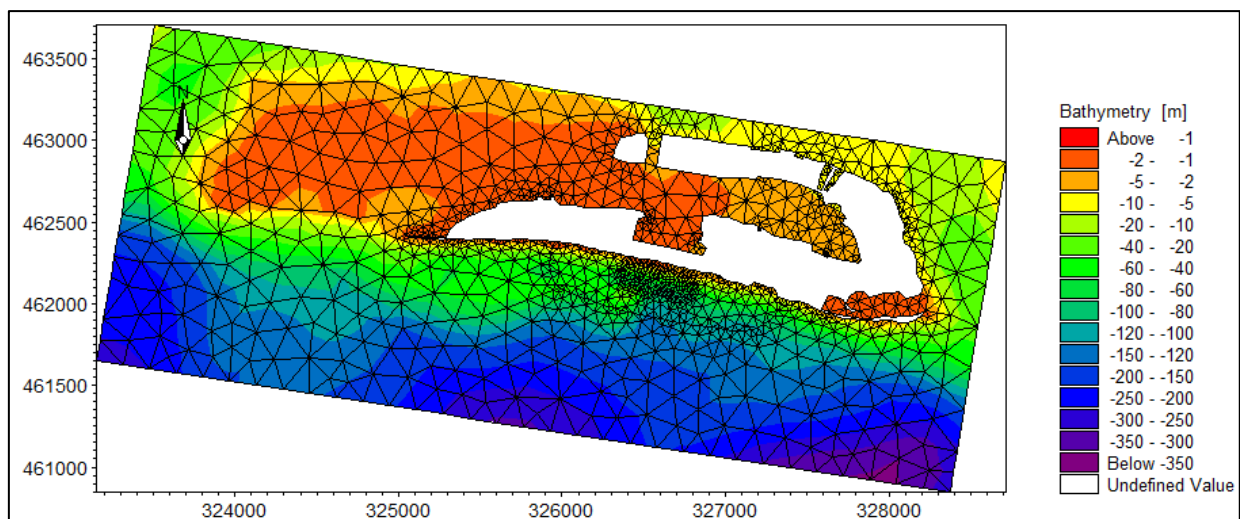
#### *4.2.1 Model Bathymetry*

Same as the wave model, Admiralty charts and bathymetry data provided by the client were used for the development of model bathymetry. Since tidal variation would be applied as main boundary condition for the regional model, availability of tidal data was considered when setting up the model. Tidal boundaries were developed using MIKE 21 Toolbox Tide developer considering 25km away from Thilafushi in North and South directions, and 45km in West and East direction. Therefore the regional model covers the model area of 50km in north-south way and 90km east-west way. Figure 4.1 illustrates the bathymetry of regional model and position of the local model on it. Local model was selected considering the bathymetry, and kept offshore boundary at 300m depth.

Triangular flexible mesh was generated by MIKE 21 Bathymetry Creator Tool while considering finer mesh size for more concern area. The UTM 43 coordinate system was used for (x, y) coordinates and Mean Sea Level (MSL) was used as the elevation datum. The local bathymetry with mesh is given in Figure 4.2.



**Figure 4.1: Bathymetry for Regional Hydrodynamic Model**



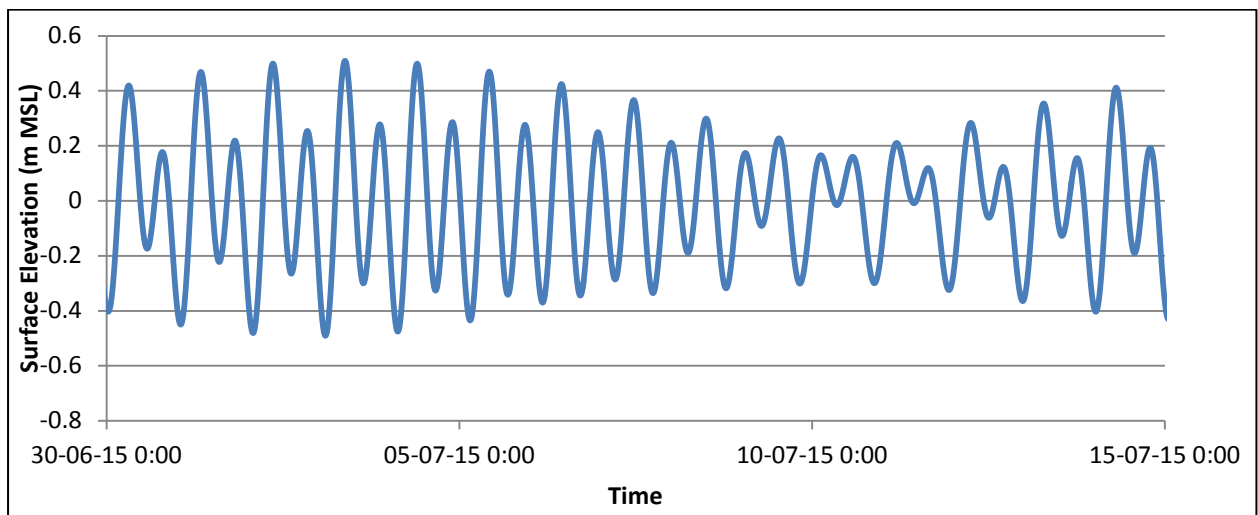
**Figure 4.2: Bathymetry for Local Hydrodynamic Model**

#### 4.2.2 Simulation Period

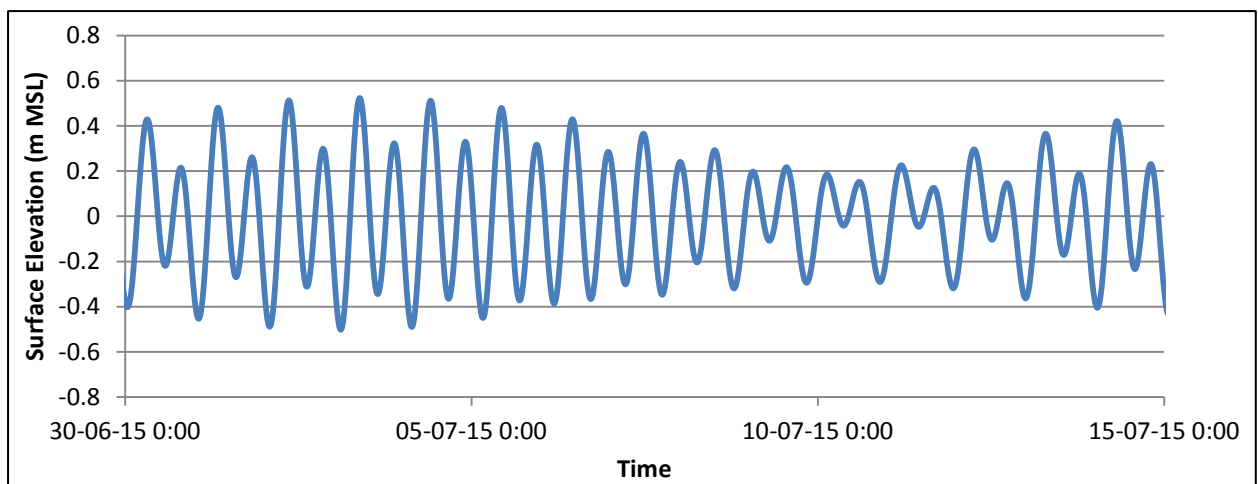
The regional model was run for one month period for each South-West and North-East monsoon and the local model was run for three days for each monsoon which covering spring and neap tide. The regional model was run with the time step of 3s and the local model with 1s.

#### 4.2.3 Boundary Conditions

The tide levels of the boundaries are used as boundary conditions for regional model. Time series of water levels were predicted using MIKE 21 Toolbox Tide developer for north and south tidal boundaries as indicated in Figure 4.1. Representative predicted tidal plots in north and south boundaries for few days in South-West Monsoon are shown in Figures 4.3 and 4.4.



**Figure 4.3: Predicted Tide in North Boundary**



**Figure 4.4: Predicted Tide in South Boundary**

Water levels and discharges extracted from regional model at the boundaries of the local model were used as boundary conditions for the local model.

#### 4.2.4 Wave and Wind Conditions

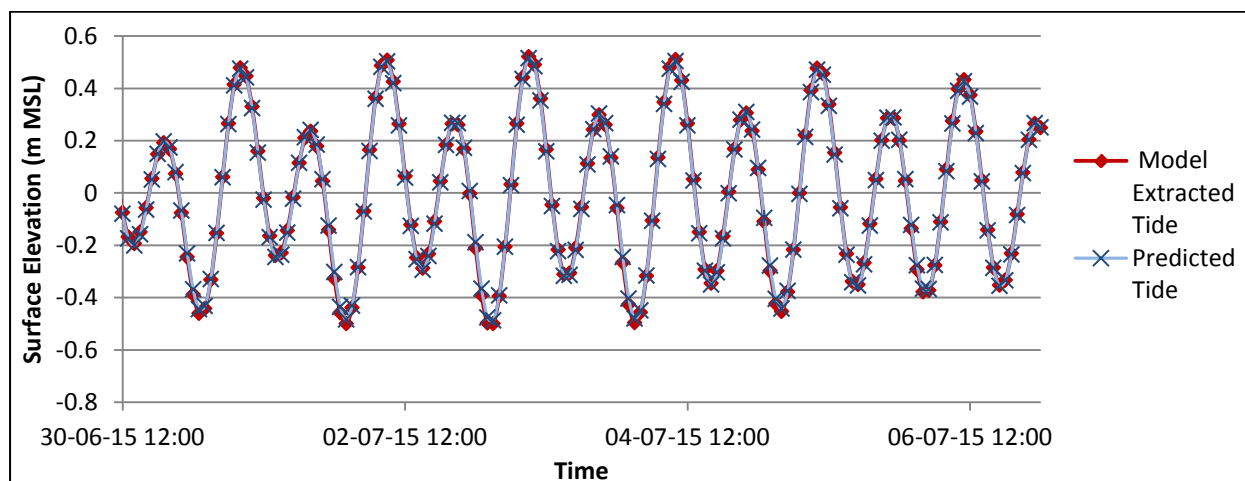
Local model was run for average wave/wind condition for both monsoons. The average condition was selected considering 50% of occurrence line of wave height of the wave data extracted at 300m depth from wave transformation model (MIKE 21 SW). In this process, most dominant directional bands were selected for the calculations (as coloured in Table 3.3 to 3.6). Same as wave, 50% of occurrence line of wind speed of UKMO wind data was selected to obtain corresponding wind speed. The selected wave and wind conditions are given in following table and both wind and wave conditions were applied at the same time in the model for each monsoon.

**Table 4.1: Applied Wave/Wind Conditions for the Local Hydrodynamic Model**

Monsoon	Wave Condition			Wind Condition	
	Hs (m)	Tp (s)	Direction (deg)	Speed (m/s)	Direction (deg)
SW	0.49	3.6	260	5.75	270
NE	0.26	2.4	60	5.02	55

### 4.3 MIKE 21 HD Model Calibration

Calibration was done for predicted tide levels at Male considering the variation of surface elevations. Figure 4.5 shows the water level comparison between model values and predicted tide at male. The bed roughness was used as the calibration parameter and Manning’s Number of 32 was set as the suitable values for the calibration.

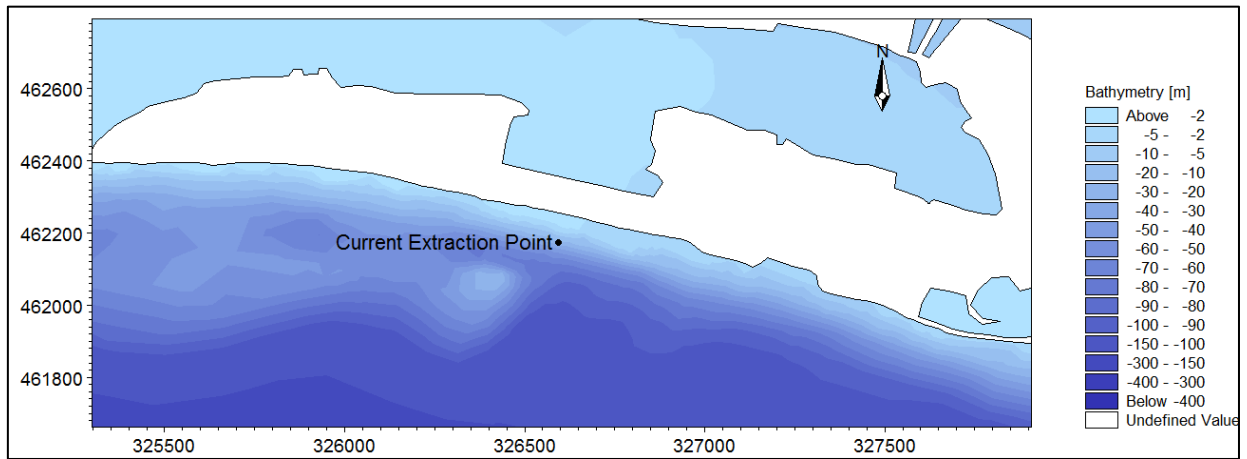


**Figure 4.5: Calibration with Predicted Tide at Male**

### 4.4 MIKE 21 HD Results

The main objective of the HD modelling is to observe the flow pattern in the site area and find out the effective current flow for thermal dispersion at outfall. Hence current speeds and directions were extracted at the outfall location (Figure 4.6) for both monsoon periods and spring and neap tidal conditions. The average current speed and direction for different conditions are given in Table 4.2. Further variations of current pattern at outfall area are given in Annex A.

According to the results, it can be observed that the wave condition is not significantly affected for the current at outfall location; it is basically tide dominant. The direction of current varies almost 180 degree with ebb and flood conditions, but Table 4.2 gives direction values only considering westward current flow condition.



**Figure 4.6: Current Extracted Points**

**Table 4.2: Average Current Condition at Extracted Point**

Monsoon	Tidal Condition	Current Speed (m/s)	Direction (deg)
SW	Neap Tide	0.10	277
	Spring Tide	0.22	280
NE	Neap Tide	0.10	280
	Spring Tide	0.20	271

## **5 THERMAL DISPERSION MODELLING**

### **5.1 Introduction**

The proposed incinerator will use sea water as the coolant and discharge hot water back to the sea. Inevitably, the temperature of water discharged is above the ambient. As temperature is one of the most important environmental variables, discharging water of such temperature will have significant impact to the aquatic organisms and to the local biological and biogeochemistry of the ocean. Impacts of high water temperature discharge are such as:

- Coral bleaching
- Reduction of dissolved oxygen level
- Stimulation of phytoplankton and benthic algal growth
- Alteration in ecosystem which affects the mortality and reproduction
- Alteration of thermal structure of the ocean, current patterns, surface wave patterns

In this modelling process, initial dilution is estimated using a near field model (CORMIX). Thereafter using its results depth average diluted thermal factors are obtained and fed them to a far field model (MIKE 21 HD Thermal Dispersion). Finally spreading of thermal plume in 2D plain can be obtained.

### **5.2 Simulation Scenarios**

Three different flow rates for three different excess temperature are required to consider in the simulations. In order to find out best location (depth) for the outfall, three different depths are proposed for the simulations. In addition, two different monsoon and tidal conditions are also considered. Therefore all together 36 number of scenarios are required to simulate. All simulation scenarios are given in the following table.

**Table 5.1: Simulation Scenarios**

Sc. ID	Monsoon	Tide	Excess Temperature (°C)	Flow Rate (m <sup>3</sup> /h)	Depth at Discharge (m)
NE_S_01	North-East	Spring	2.5	16.56	10
NE_S_02					20
NE_S_03					30
NE_S_04			5	8.28	10
NE_S_05					20
NE_S_06					30
NE_S_07			10	6.21	10
NE_S_08					20
NE_S_09					30
NE_N_01		Neap	2.5	16.56	10
NE_N_02					20
NE_N_03					30
NE_N_04			5	8.28	10
NE_N_05					20
NE_N_06					30
NE_N_07			10	6.21	10
NE_N_08					20
NE_N_09					30
SW_S_01	South-West	Spring	2.5	16.56	10
SW_S_02					20
SW_S_03					30
SW_S_04			5	8.28	10
SW_S_05					20
SW_S_06					30
SW_S_07			10	6.21	10
SW_S_08					20
SW_S_09					30
SW_N_01		Neap	2.5	16.56	10
SW_N_02					20
SW_N_03					30
SW_N_04			5	8.28	10
SW_N_05					20
SW_N_06					30
SW_N_07			10	6.21	10
SW_N_08					20
SW_N_09					30

### **5.3 Near Field Modelling**

The given outfall pipe diameter is 300mm. Accordingly discharge velocity of plume is between 0.065m/s and 0.0244m/s which are significantly low compared to the sea current at location. It will be released close to the sea bottom. Since the density of the heated plume is less it will act as negatively buoyant discharges and tends to move upwards. The initial momentum of the discharge will lead to a very turbulent flow that will attempt to mix the fluid over the full depth available. This mixing will be resisted by the fact that the discharge is buoyant. The mixing will also cause ambient fluid to be entrained into the jet, reducing its momentum and temperature. This initial momentum is very important and generally reduces the excess temperature by a factor of 2 to 3 over a distance of a few meters. Once the discharge momentum has been reduced below a certain limit due to the dilution, the mixing will cease to be the dominant factor and the discharge will transform into what is generally known as a plume. After this the discharge enters the far field. To examine the near field behaviour of the heated plume CORMIX mixing zone model is used.

#### **5.3.1 Cormix Modelling System**

The CORMIX is a mixing zone model and decision support system for environmental impact assessment of regulatory mixing zones resulting from continuous point source discharges (Doneker & Jirka 2007). It is a computer-aided-design (CAD) developed by the Defrees Hydraulic Laboratory at Cornell University, Ithaca, New York, in cooperation of USEPA for studying aqueous pollutant discharges into a range of water bodies, design and mixing zone analysis (Doneker & Jirka 2007). The role of boundary interaction is the emphasis of the system for predicting steady-state mixing behaviour and plume geometry (Doneker & Jirka 2007).

Simulation model selection in CORMIX is controlled by the Graphical user interface (GUI) and mixing zone rule-based expert systems technology. Description of discharge and ambient conditions are specified as input data in the GUI. Based on the inputs, the most appropriate hydrodynamic simulation model is determined. CORMIX employs the length-scaled rule-based system for classification of flow regimes and uses the length scale for predicting the initial dilution. CORMIX simplifies the characteristics of each stage in the steady-state condition and predicts the plume dilution by using some empirical equations (Etemad-Shahidi & Azimi 2007).

CORMIX is applicable to wide range of problems from a simple single submerge pipe discharge into a small stream with rapid cross-sectional mixing to a complicated multiport diffuser installation in deeply-stratified coastal water. However, there is lack of applicability in highly unsteady ambient flow conditions that are prone to locally recirculating flows (Doneker & Jirka 2007).

The main aim is to obtain an estimation of spreading of heated plume around the discharge. The model set up used the excess temperature as a tool to access the change in temperature



level. Based on the requirement, four different water depths were considered for outfall and simulations were carried out accordingly for considering all the relative environmental conditions.

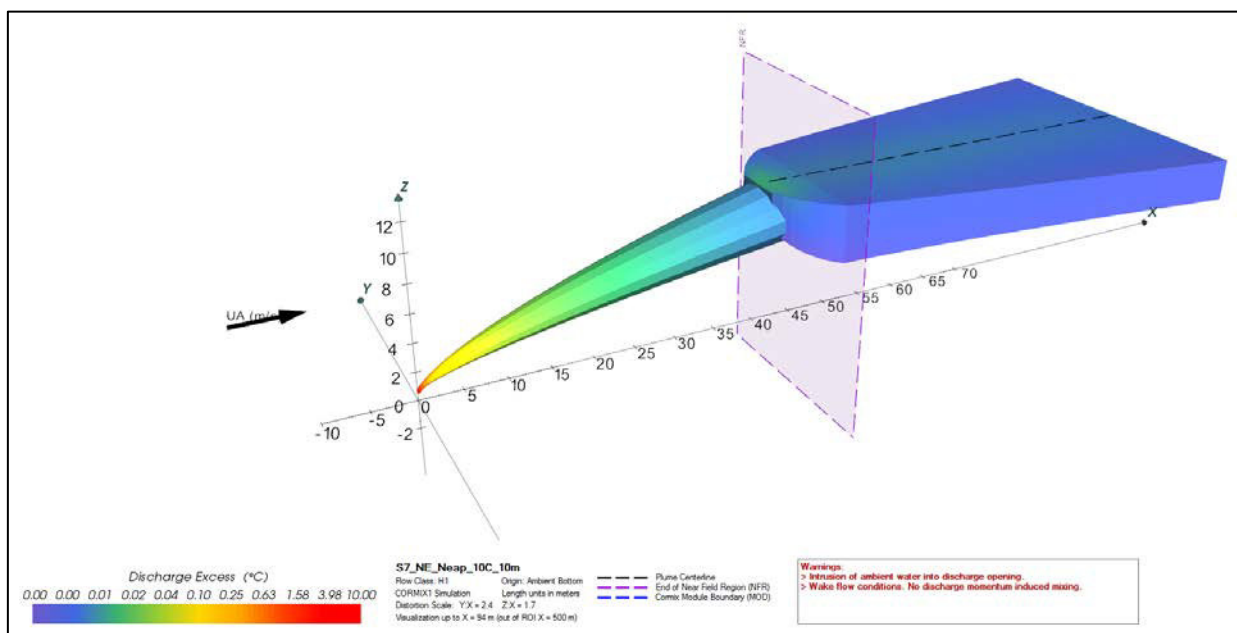
### 5.3.2 Model Simulations

As discussed earlier dilution process can be divided into a primary jet dilution in the so-called **near-field** and a subsequent natural dilution in the **far-field**. The natural dilution (far field) is influenced by waves, currents and environment conditions.

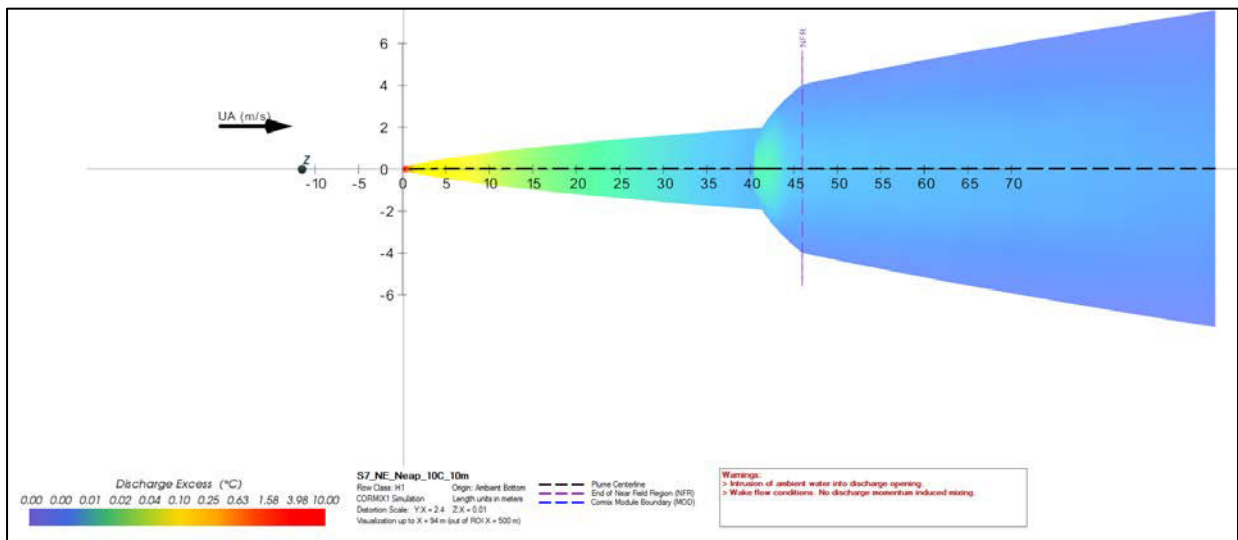
In general near field of an outfall is governed by the initial jet characteristics of the plume and outfall geometry. In this case, horizontal single port discharge is considered in the modelling simulations. The density of effluent was varied from 1017m<sup>3</sup>/kg to 1020m<sup>3</sup>/kg according to the excess temperature and the ambient density of the sea water is considered as 1025m<sup>3</sup>/kg. Ambient temperature level is assumed as 28°C. Simulations were carried out for list of scenarios given in Table 5.1.

### 5.3.3 CORMIX Model Results

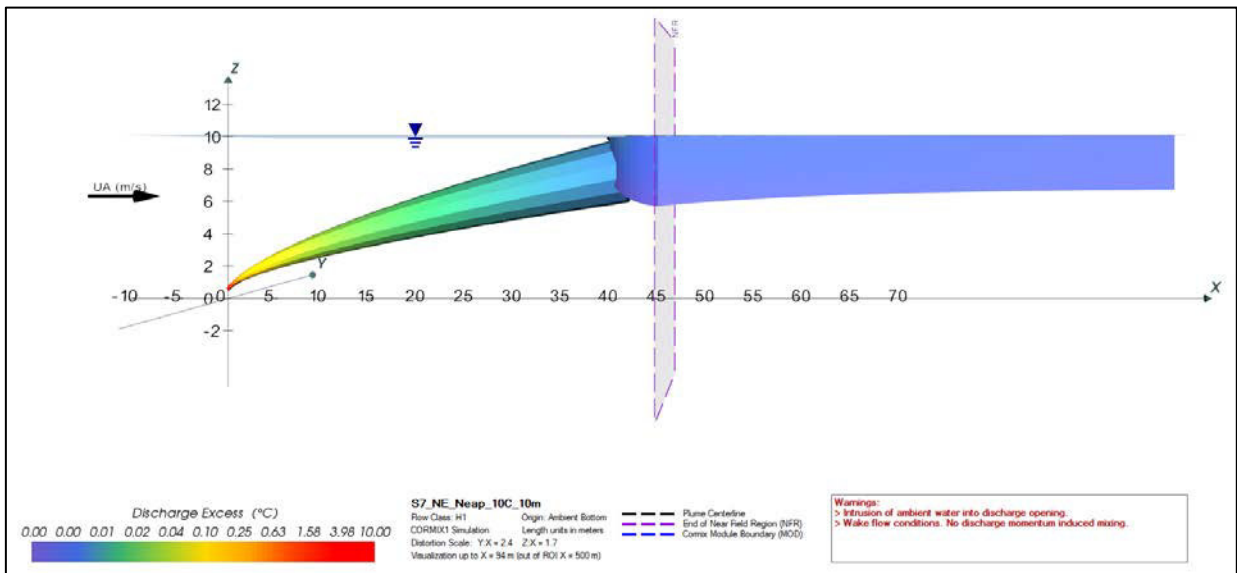
Visualization of the effluent discharged from the port and rising to the surface in a cross flow at near-field region is given below for the simulation of North-East monsoon with neap tide and excess temperature 10°C and depth of discharge 10m (Sc. ID: NE\_N\_07). Both plan view and the elevation of the plume of for this scenario are given below and 3D view plots for rest of simulations are given in Annex B.



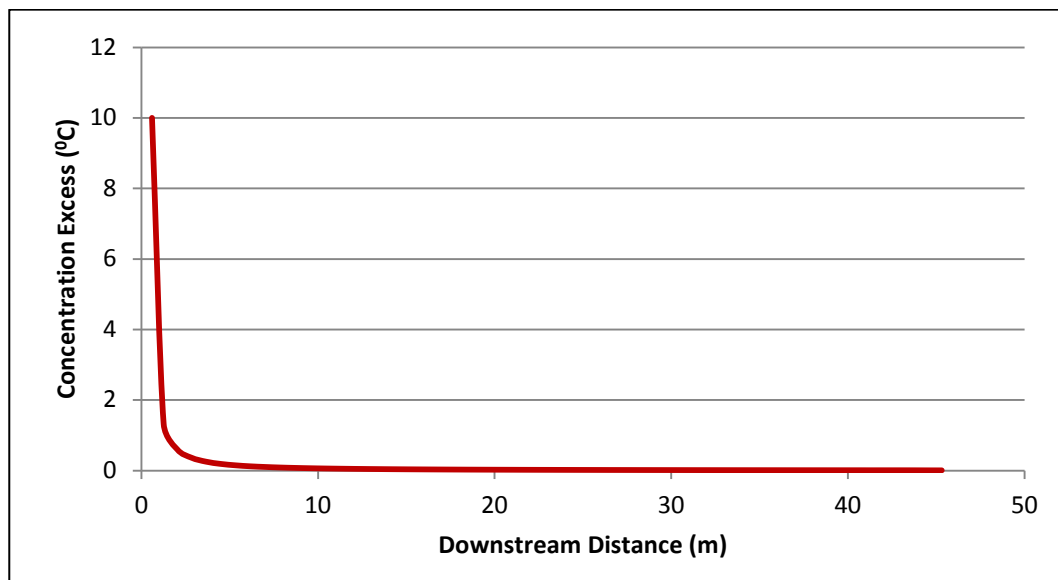
**Figure 5.1: Visualization of the Effluent Discharged from the Port and Rising to the Surface at Near-Field Region (3D View)**



**Figure 5.2: Visualization of the Effluent Discharged from the Port and Rising to the Surface in a Cross Flow at Near-Field Region. (Plan View)**



**Figure 5.3: Visualization of the Effluent Discharged from the Port Spreading at Near-Field Region. (Elevation)**



**Figure 5.4: Excess Concentration vs. Downstream Distance**

### 5.3.4 Discussion

According to the results of above scenario, relatively high influence can be observed with low depth release, high temperature plume and low current speed. Hence plume discharge at 10m depth with 10°C excess temperature at neap tidal condition is the most influence scenario in near-field modelling. There are two scenario which satisfy these condition; scenario IDs of those are **NE\_N\_07** and **SW\_N\_07**. Hence the above selected scenario is one of most influential condition among all scenarios. Even with this most influential condition, high dilution can be observed due to low flow rate of effluent. The excess temperature reduces to less than 1°C within few meters of downstream distance. Therefore effect on coastal environment with this discharge is negligible.

## 5.4 Far Field Modelling

As discussed earlier two models were used to assess the dispersion pattern of the heat plume, one for the near field and one for the far field. The use of the semi-empirical length scale model, CORMIX, for the near field is described in Section 5.3.

As the turbulent plume travels further away from the discharge location, the jet characteristics become less important and three dimensional treatment of thermal dispersion is nearly changed to two dimensional treatments. Then in order to simulate the current phenomena, it is possible to use two-dimensional models. MIKE 21 Hydrodynamic Model combine with Thermal Dispersion Tool has been used for hydrodynamic and thermal dispersion simulation in far field region.

#### **5.4.1 Input Data**

All input parameters used in local hydrodynamic model (as given in Chapter 4) are used for thermal dispersion modelling. Therefore two different monsoon conditions (South-West and North-East) and two different tidal conditions (Spring and Neap) are taken into consideration in the simulation. In addition, heat plume discharge boundary for far-field simulation is established using the near-field model (CORMIX) results. The excess temperature was extracted in mean water depth from CORMIX model and given as an input data for MIKE 21 HD thermal dispersion model. The excess temperature extracted for different scenarios are given in Table 5.2.

**Table 5.2: Input Excess Temperature for Far-Field Model**

Sc. ID	Monsoon	Tide	Excess Temperature (°C)	Flow Rate (m <sup>3</sup> /h)	Depth at Discharge (m)	Excess Temperature at Average Depth(°C)
NE_S_01	North-East	Spring	2.5	16.56	10	0.015
NE_S_02					20	0.002
NE_S_03					30	0.001
NE_S_04			5		10	0.006
NE_S_05					20	0.002
NE_S_06					30	0.001
NE_S_07			10		10	0.011
NE_S_08					20	0.004
NE_S_09					30	0.002
NE_N_01		Neap	2.5	16.56	10	0.015
NE_N_02					20	0.004
NE_N_03					30	0.002
NE_N_04			5		10	0.016
NE_N_05					20	0.004
NE_N_06					30	0.002
NE_N_07			10		10	0.024
NE_N_08					20	0.005
NE_N_09					30	0.002
SW_S_01	South-West	Spring	2.5	16.56	10	0.007
SW_S_02					20	0.002
SW_S_03					30	0.001
SW_S_04			5		10	0.005
SW_S_05					20	0.001
SW_S_06					30	0.001
SW_S_07			10		10	0.007
SW_S_08					20	0.002
SW_S_09					30	0.001
SW_N_01		Neap	2.5	16.56	10	0.016
SW_N_02					20	0.004
SW_N_03					30	0.002
SW_N_04			5		10	0.016
SW_N_05					20	0.004
SW_N_06					30	0.002
SW_N_07			10		10	0.024
SW_N_08					20	0.005
SW_N_09					30	0.002

#### **5.4.2 Model Results and Discussion**

Since the discharge flow rate is considerably low, high dilution can be observed at outfall area. Hence the mean depth excess temperature is very low. However the extracted values were added to the far-field model and obtained the results.

High influence can be observed at low depth discharge same as near-field model, but high heat distribution can also be observed for high effluent flow rate condition even it has low excess temperature. As an example Sc. ID: NE\_S\_01 has excess temperature 2.5°C in the effluent, but it has 16.56m<sup>3</sup>/h flow rate which is comparatively high. Therefore results of this scenario shows high heat distribution. Further scenarios with neap tidal condition shows higher influence with its low current speed than spring tide. According to these conditions high influence scenarios are;

- a) NE\_S\_01
- b) NE\_N\_01
- c) NE\_N\_07
- d) SW\_S\_01
- e) SW\_N\_01
- f) SW\_N\_07

As an example Sc. ID: NE\_N\_07 has been used for further discussion which was critical in near-field model too. Figure 5.5 and 5.6 show the temperature variation in 2D plain for this high influence scenario when current directed westward and eastward respectively. According to the results, the excess temperature level reduces  $5 \times 10^{-6}$  °C within the 90m range from the discharge point for both cases. However  $5 \times 10^{-6}$  °C excess temperature is very low temperature and negligible in coastal environment. Therefore thermal dispersion is very high even in a high influence scenario and it will be a very low effect to the coastal environment. Thermal dispersion plots for all scenarios are given in Annex C.

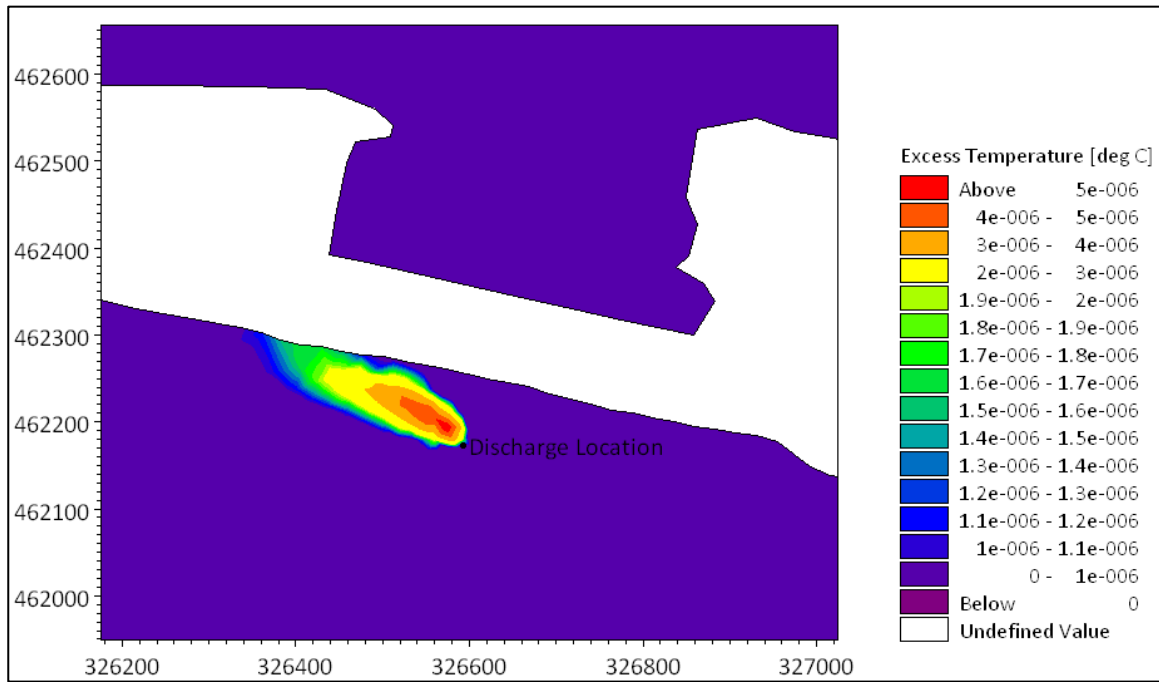


Figure 5.5: Thermal Dispersion towards West at Scenario NE\_N\_07

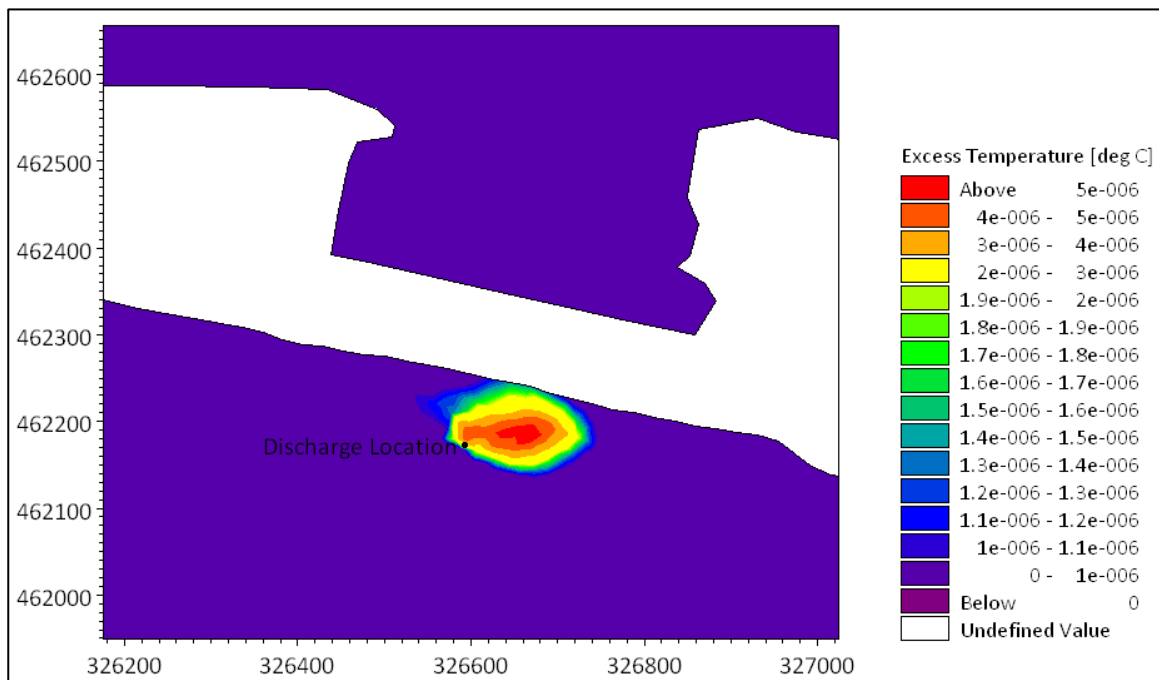


Figure 5.6: Thermal Dispersion towards East at Scenario NE\_N\_07

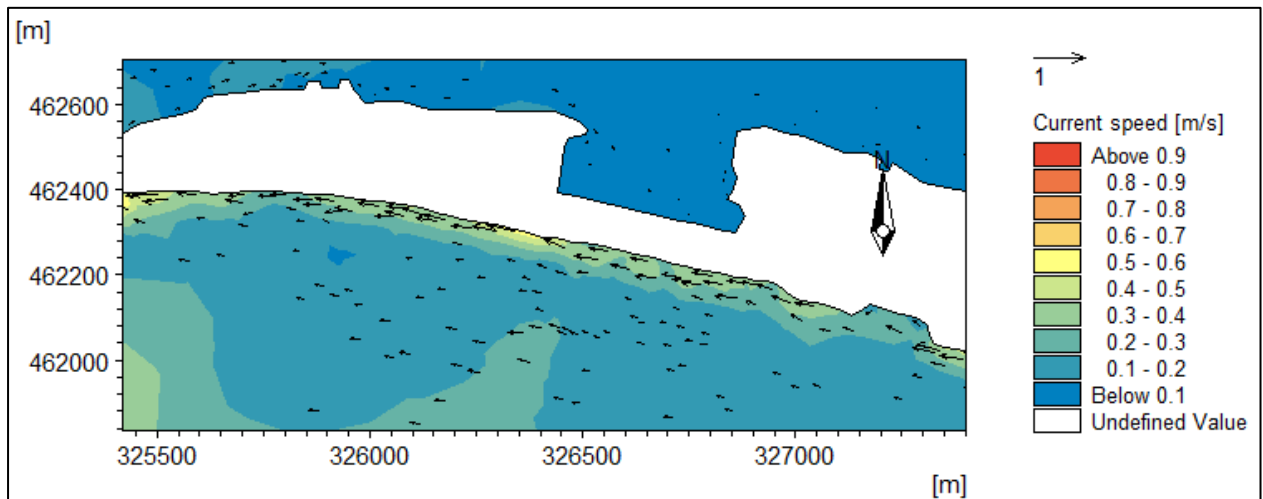
## 6 SUMMARY AND CONCLUSION

- In order to find out thermal dispersion in coastal environment for outfall of hot water plume of a proposed incinerator at Thilafushi Island, a set of numerical model simulation was carried out for different design conditions and seasonal conditions.
- Measured data as well as reliable predicted data were utilized as model inputs, and analysed them before applied to the model.
- MIKE 21 SW model was used to establish the wave condition at site for different monsoon periods (South-West and North-East) and MIKE 21 HD model was used to obtain the current condition at discharge location. Further both spring and neap tidal conditions were simulated separately; and about 0.2m/s and 0.1m/s average current speed were obtained at the discharge point for spring and neap tide respectively. Wave condition was not significantly affected on current condition at discharge point.
- Two modelling system were used thermal dispersion modelling, namely CORMIX model for **near-field** dispersion and MIKE 21 HD coupled with thermal dispersion tool for **far-field** dispersion.
- According to near-field model results,
  - High dilution can be observed due to low flow rate of effluent.
  - High temperature reduction was observed within few meters from released point. Even in one of most influential scenario (Sc. ID: NE\_N\_07) which has low depth of discharge (10m), high excess temperature (10°C) and low current speed (0.1m/s), temperature reduces to 1°C within 3m of range.
- Results obtained from near-field model were used as input parameter for far-field model.
- Far-field model results represent the temperature spreading in 2D plain for different scenarios.
- According to far-field model results,
  - High heat distribution can be observed with high effluent flow rate, but excess temperature is very low and negligible in coastal environment.
  - Same as the near-field model low depth discharge creates some influence comparative to the other conditions.

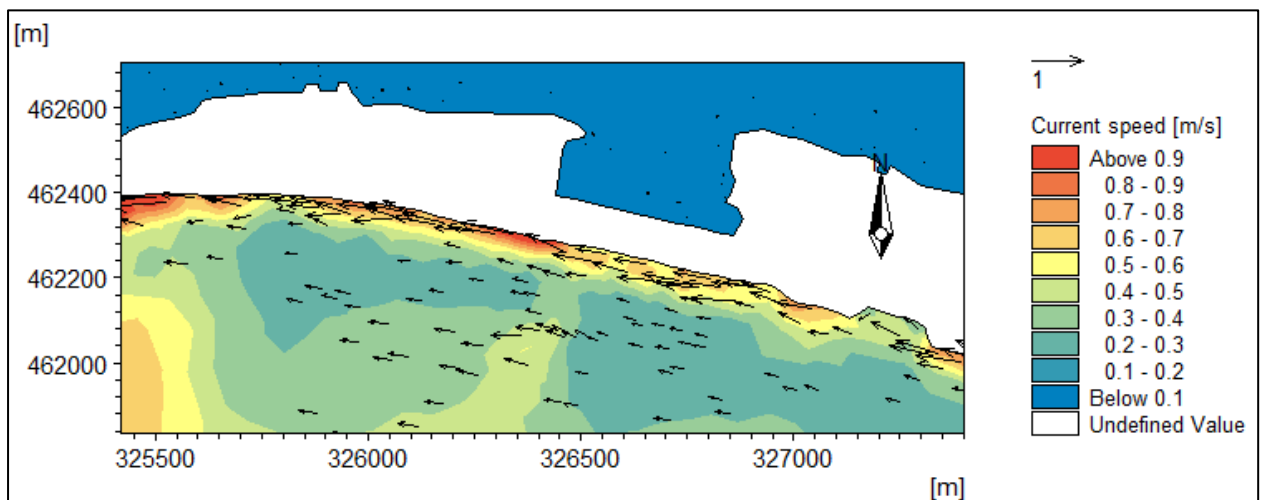


# **ANNEX A**

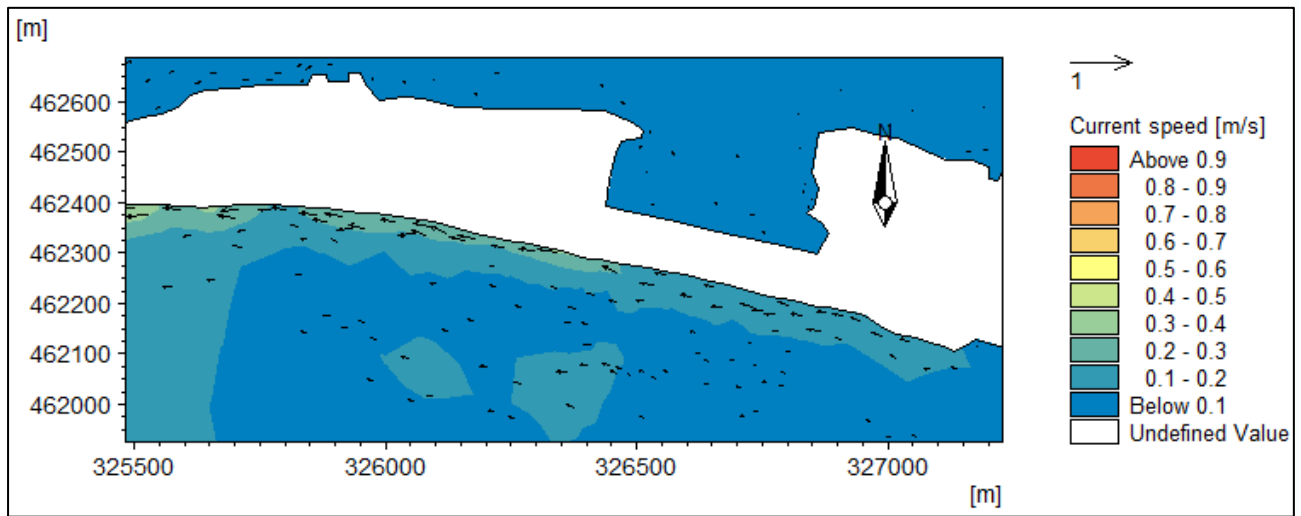
## **Current Speed Vector Plots**



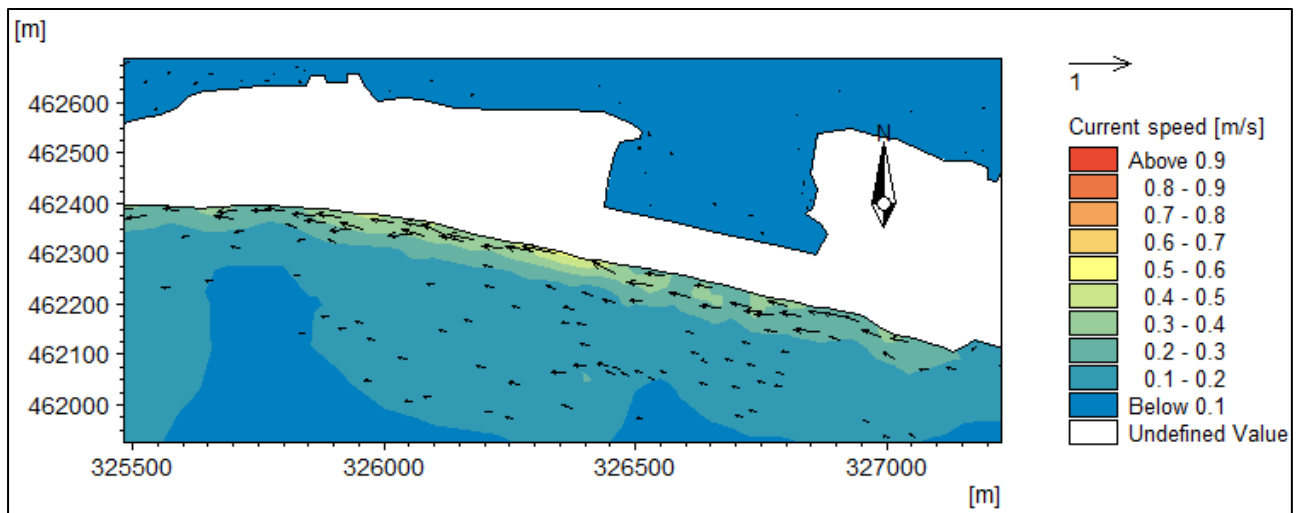
**Figure A.1: SW Monsoon, Spring Tide, Average Condition**



**Figure A.2: SW Monsoon, Spring Tide, Maximum Condition**



**Figure A.3: SW Monsoon, Neap Tide, Average Condition**



**Figure A.4: SW Monsoon, Neap Tide, Maximum Condition**

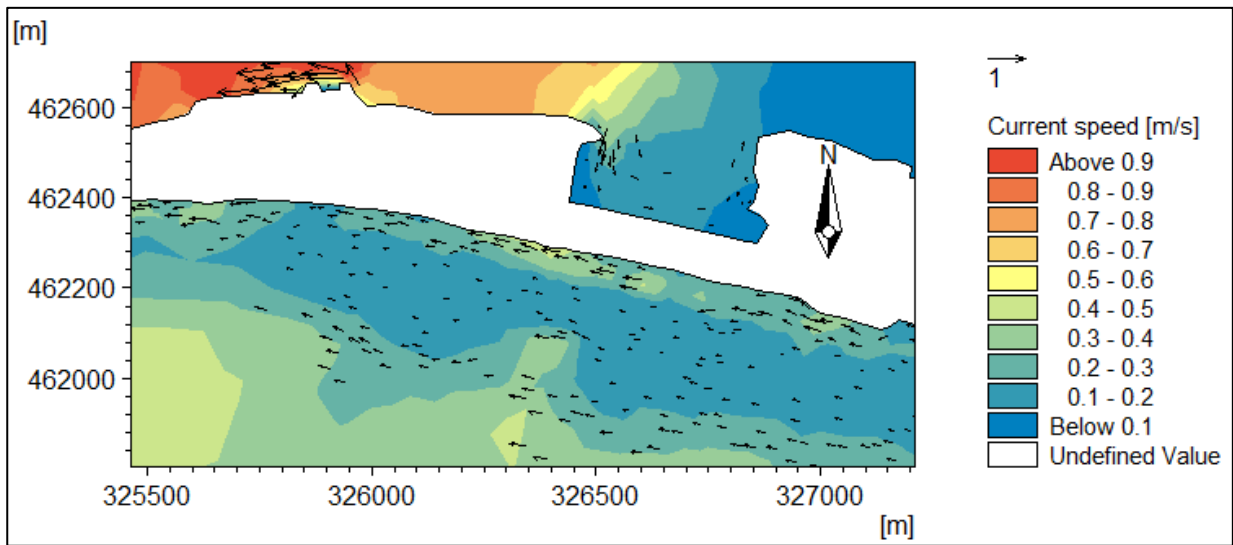


Figure A.5: NE Monsoon, Spring Tide, Average Condition

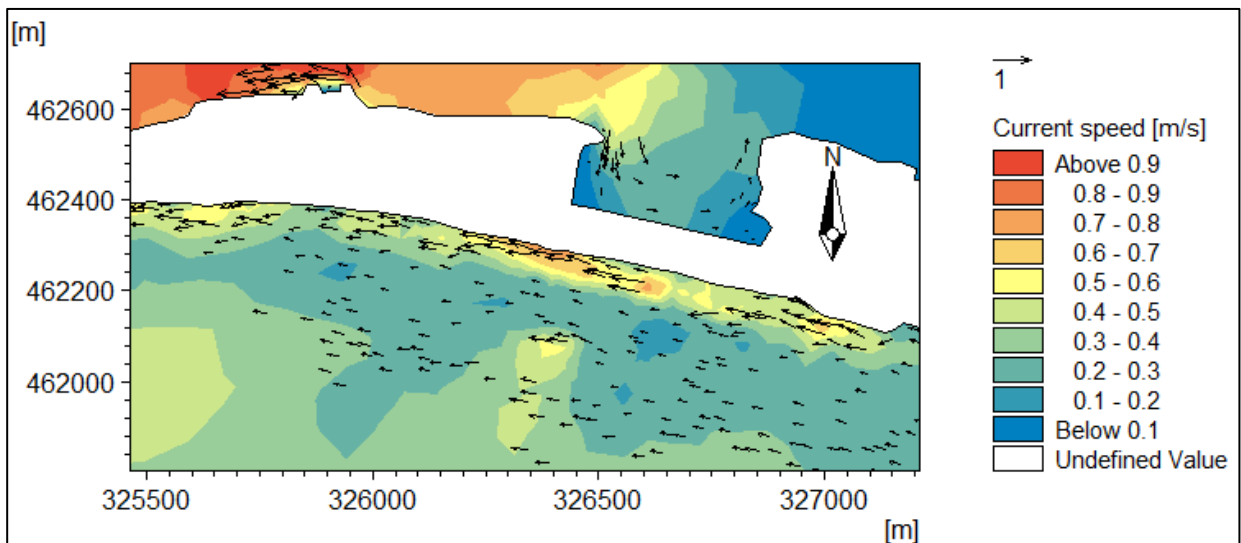


Figure A.6: NE Monsoon, Spring Tide, Maximum Condition

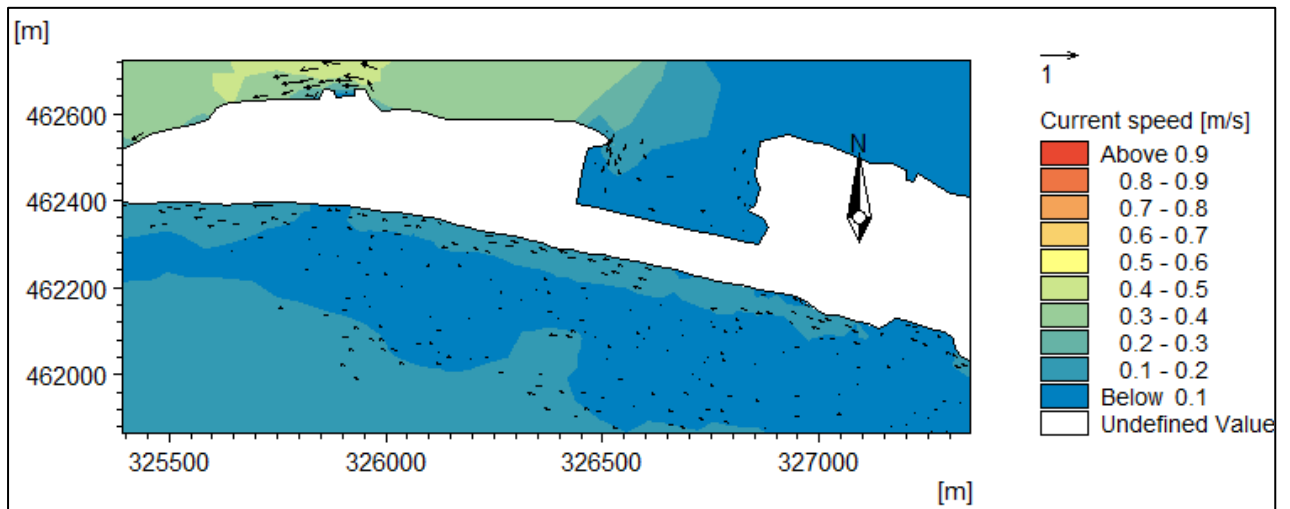


Figure A.7: NE Monsoon, Neap Tide, Average Condition

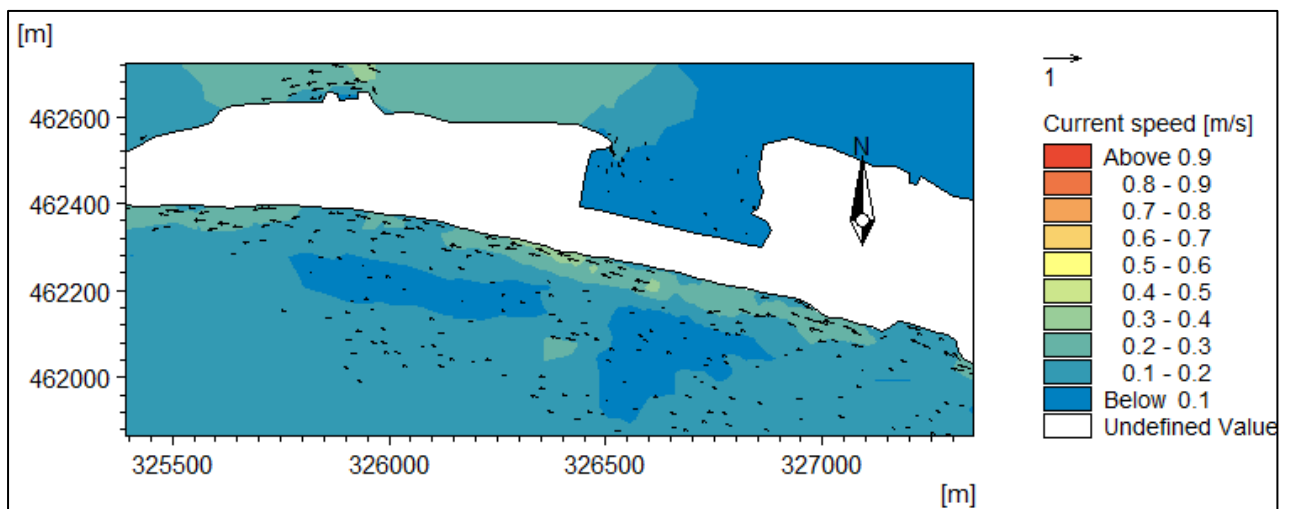


Figure A.8: NE Monsoon, Neap Tide, Maximum Condition

## **ANNEX B**

### **Heat Dissipation in Near Field (CORMIX)**

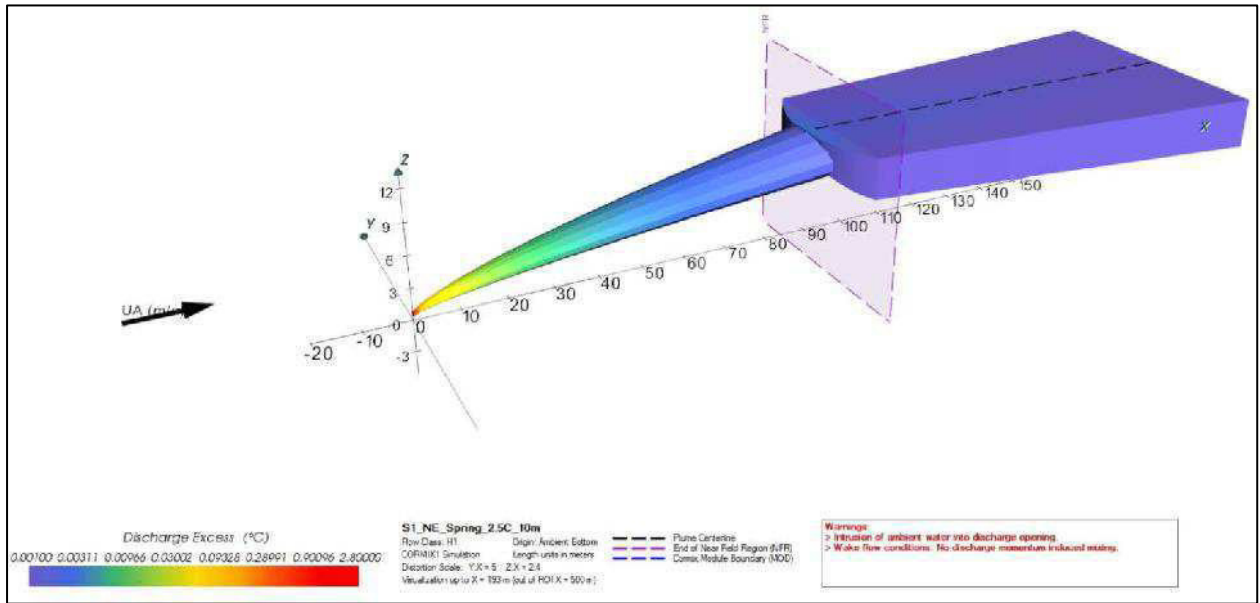


Figure B1: NE\_S\_01\_ (Ex. Temp.=2.5°C, Flow Rate=16.56 m<sup>3</sup>/h, Depth=10m)

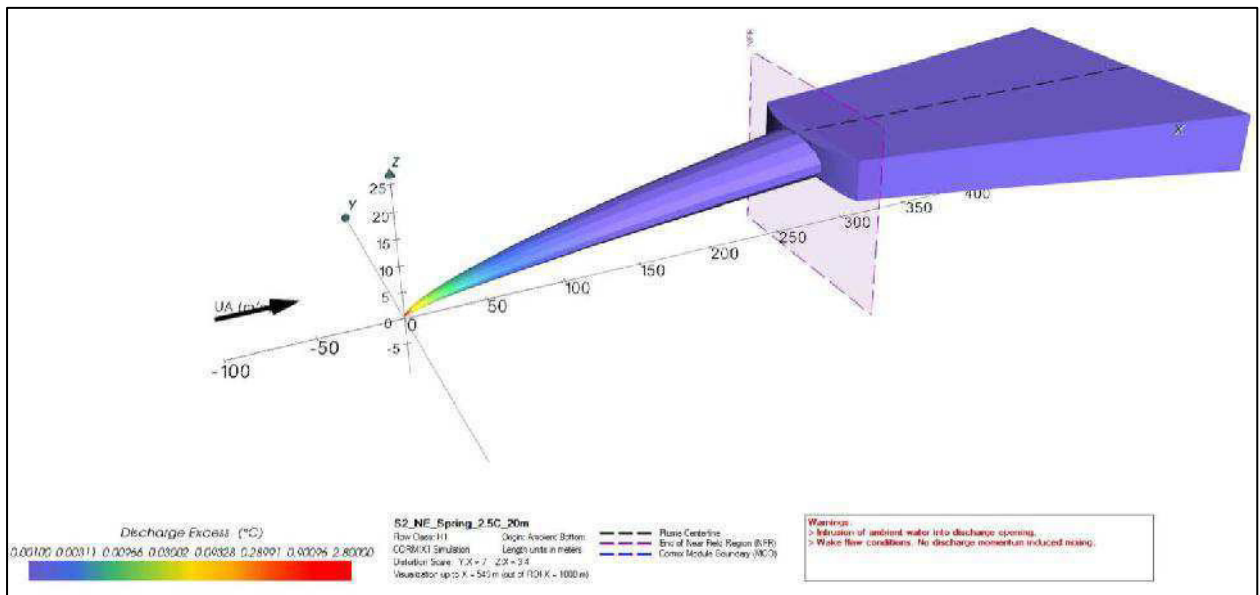


Figure B2: NE\_S\_02\_ (Ex. Temp.=2.5°C, Flow Rate=16.56 m<sup>3</sup>/h, Depth=20m)

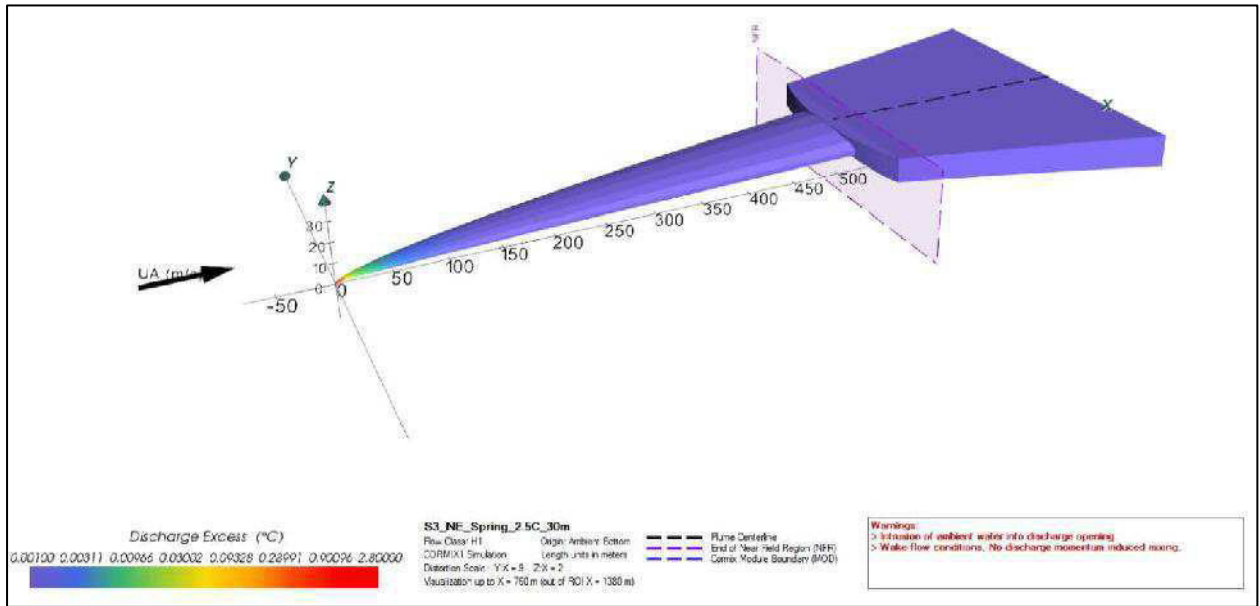


Figure B3: NE\_S\_03\_ (Ex. Temp.=2.5°C, Flow Rate=16.56 m<sup>3</sup>/h, Depth=30m)

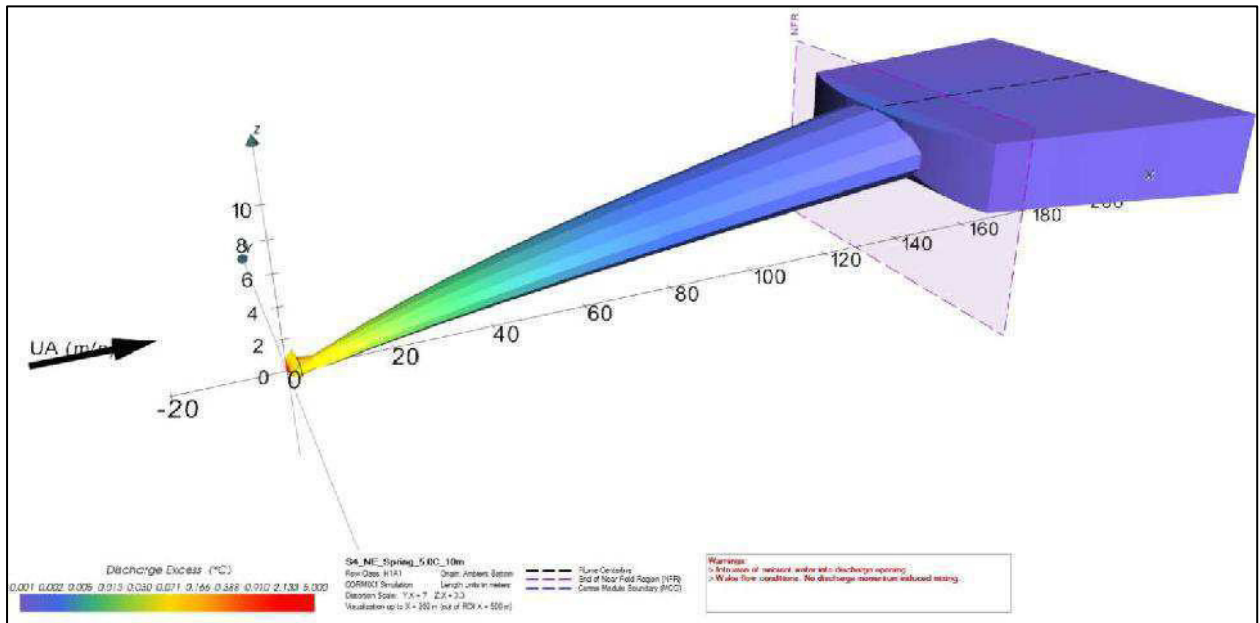


Figure B4: NE\_S\_04\_ (Ex. Temp.= 5°C, Flow Rate=8.28 m<sup>3</sup>/h, Depth=10m)



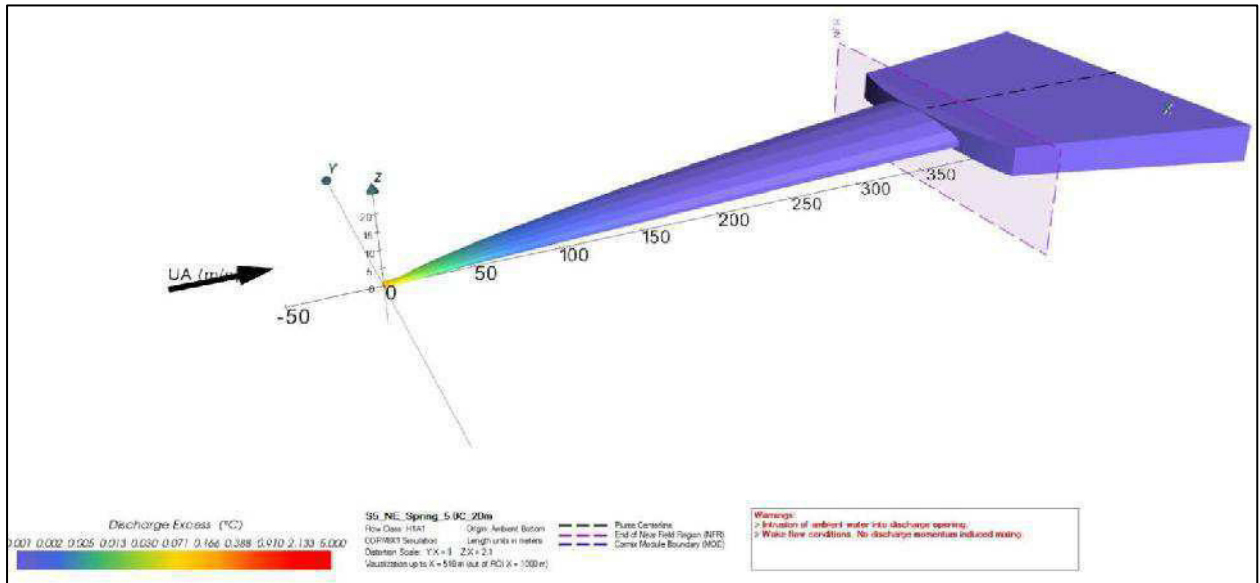


Figure B5: NE\_S\_05\_ (Ex. Temp.= 5°C, Flow Rate=8.28 m<sup>3</sup>/h, Depth=20m)

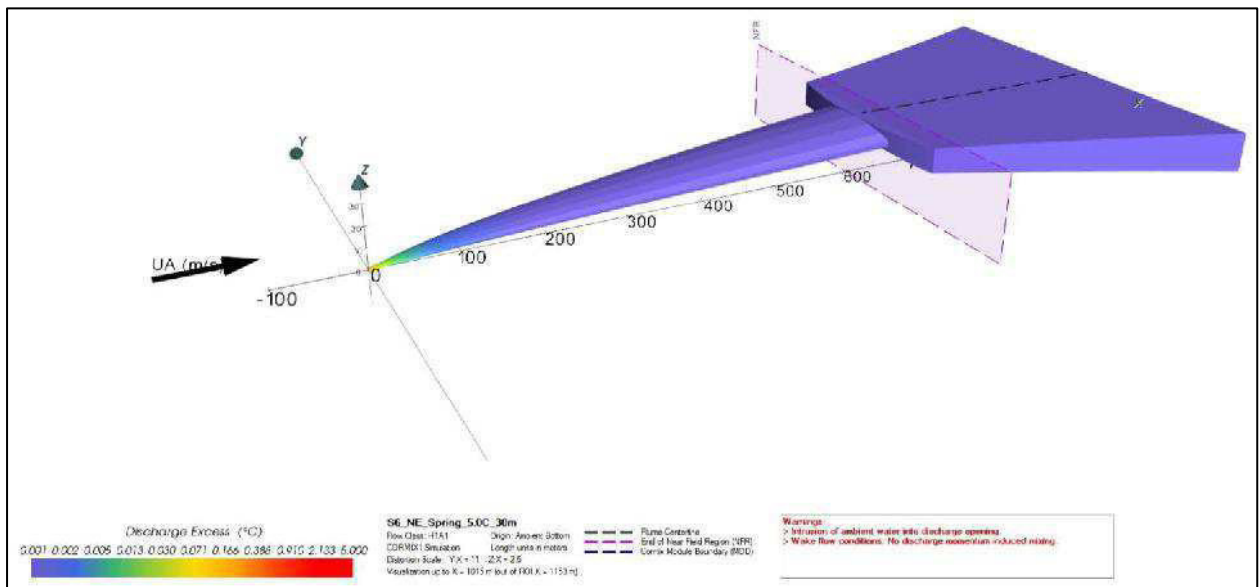


Figure B6: NE\_S\_06\_ (Ex. Temp.= 5°C, Flow Rate=8.28 m<sup>3</sup>/h, Depth=30m)

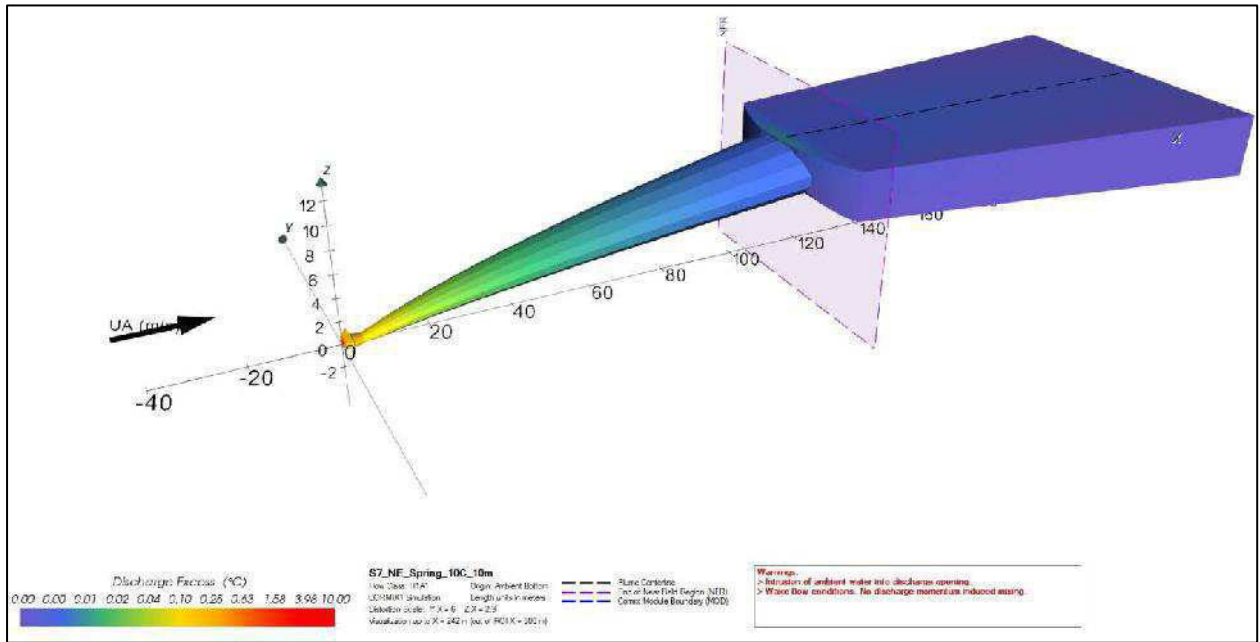


Figure B7: NE\_S\_07\_ (Ex. Temp.= 10°C, Flow Rate=6.21 m<sup>3</sup>/h, Depth=10m)

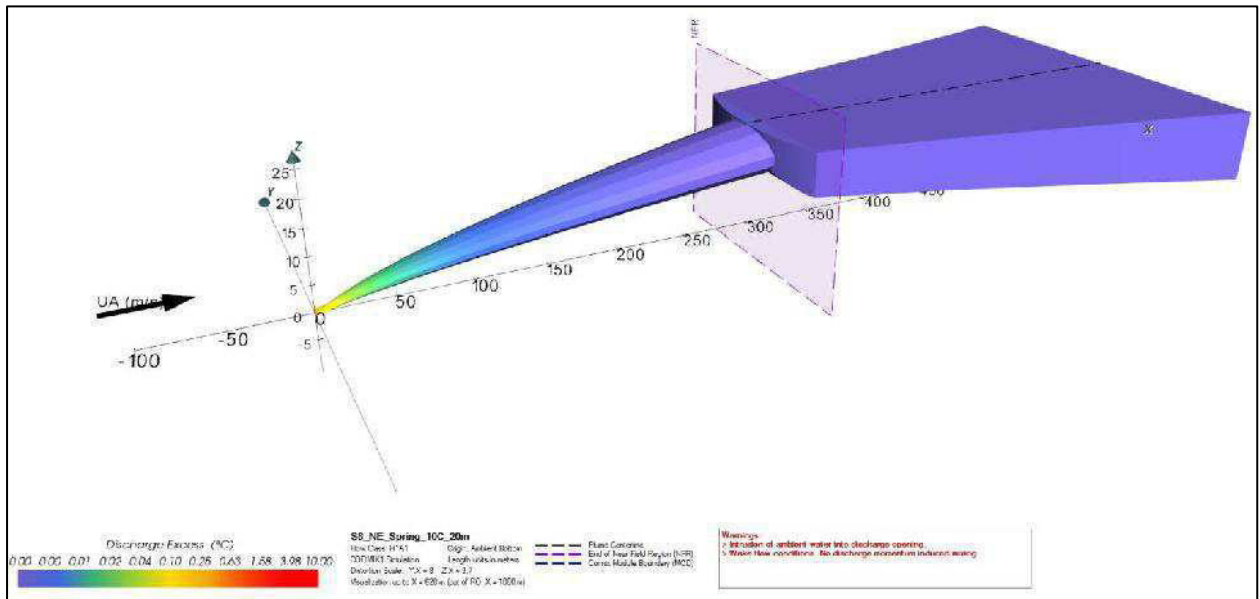


Figure B8: NE\_S\_08\_ (Ex. Temp.= 10°C, Flow Rate=6.21 m<sup>3</sup>/h, Depth=20m)

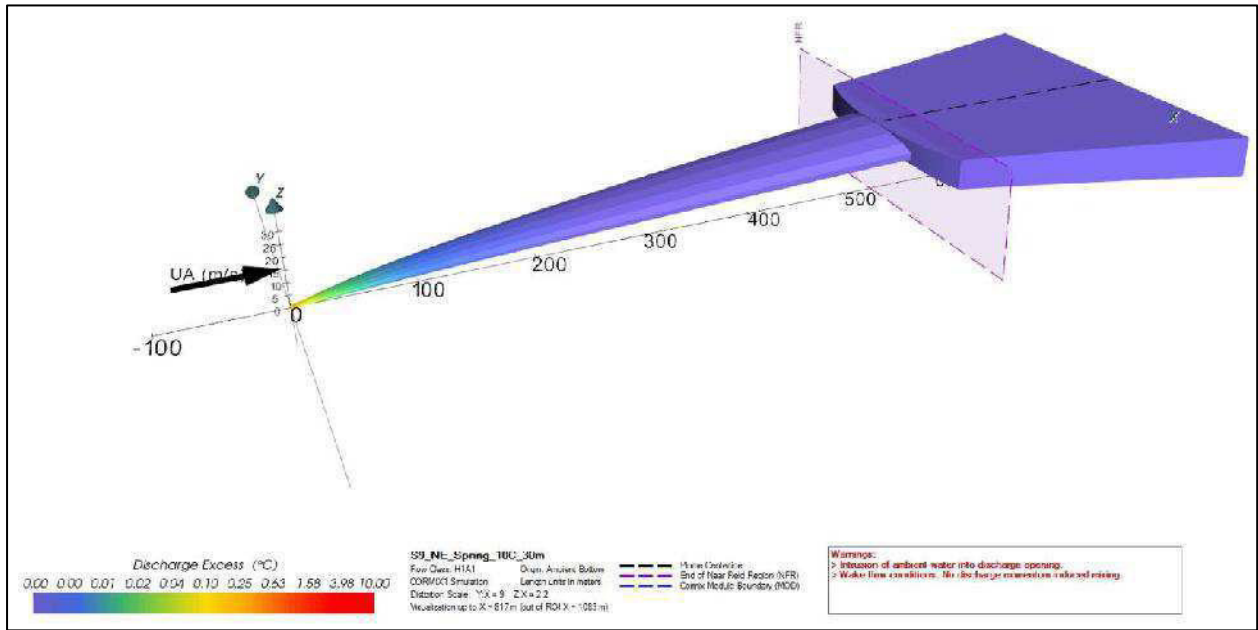


Figure B9: NE\_S\_09\_ (Ex. Temp.= 10°C, Flow Rate=6.21 m<sup>3</sup>/h, Depth=30m)

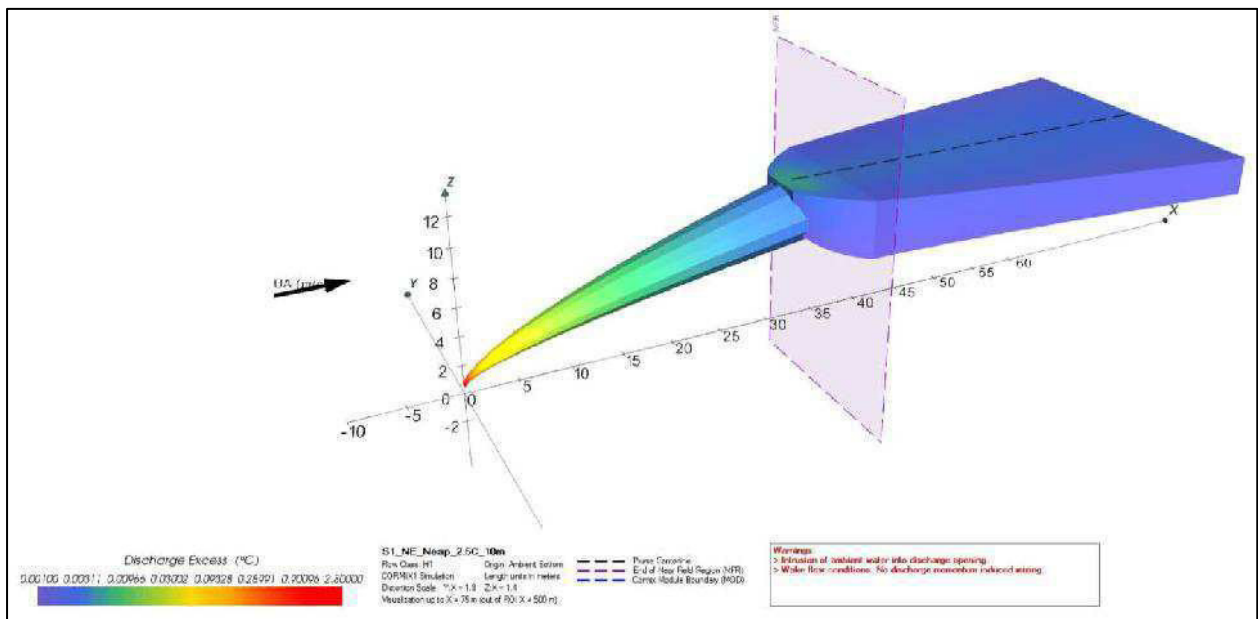


Figure B10: NE\_N\_01\_ (Ex. Temp.= 2.5°C, Flow Rate=16.56 m<sup>3</sup>/h, Depth=10m)

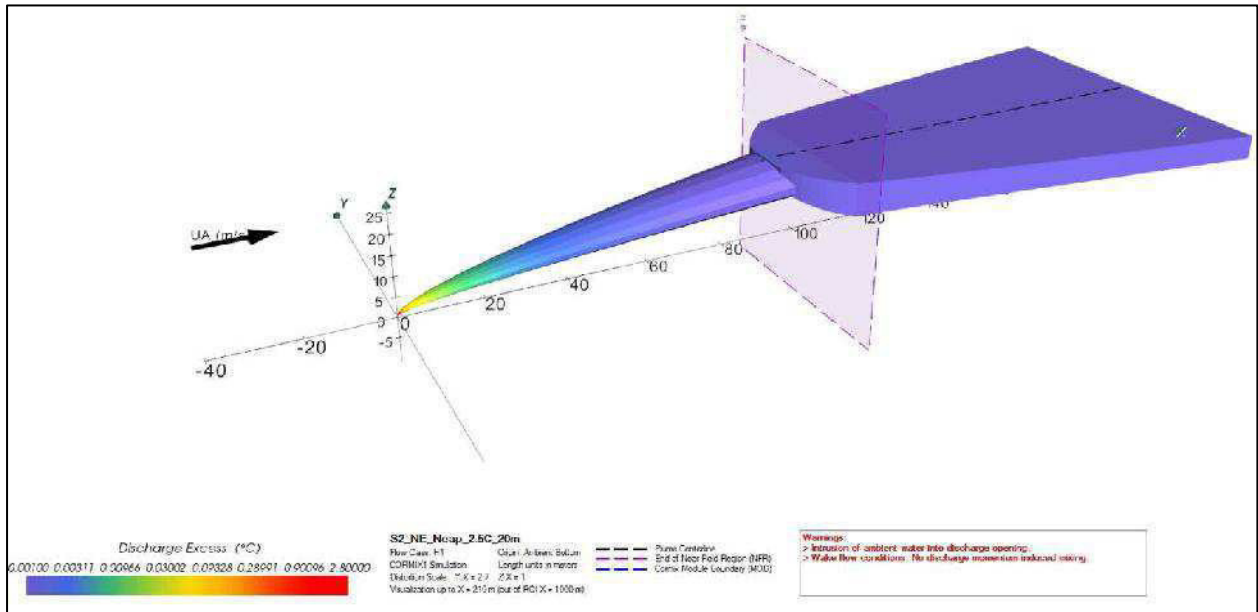


Figure B11: NE\_N\_02\_ (Ex. Temp.= 2.5°C, Flow Rate=16.56 m<sup>3</sup>/h, Depth=20m)

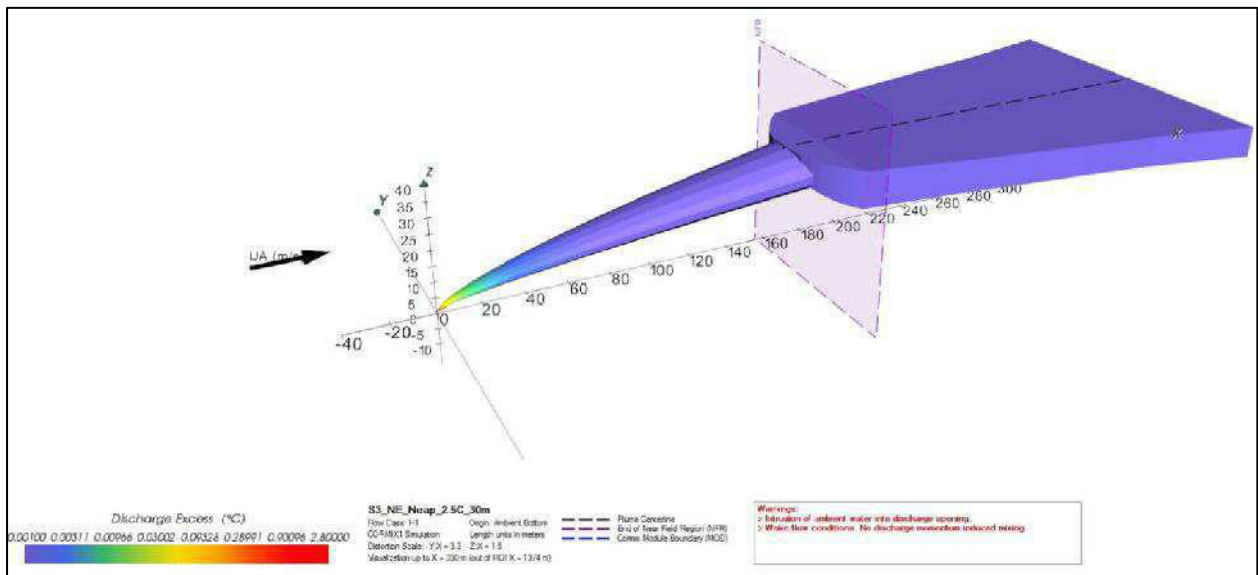


Figure B12: NE\_N\_03\_ (Ex. Temp.= 2.5°C, Flow Rate=16.56 m<sup>3</sup>/h, Depth=30m)

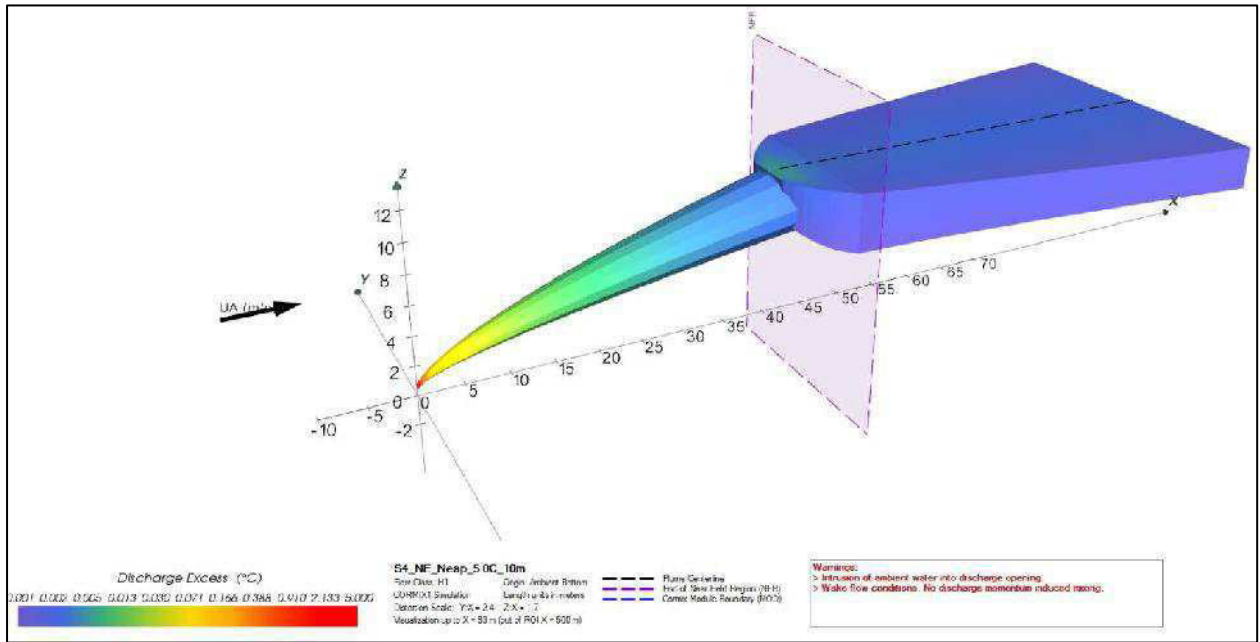


Figure B13: NE\_N\_04\_ (Ex. Temp.= 5°C, Flow Rate=8.28 m<sup>3</sup>/h, Depth=10m)

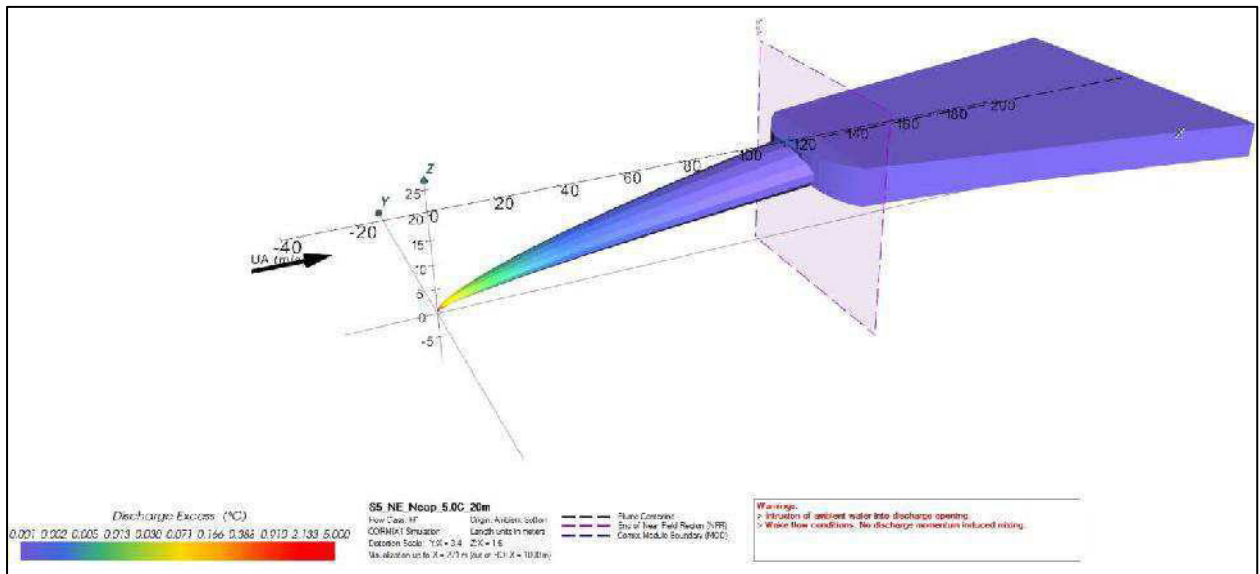


Figure B14: NE\_N\_05\_ (Ex. Temp.= 5°C, Flow Rate=8.28 m<sup>3</sup>/h, Depth=20m)

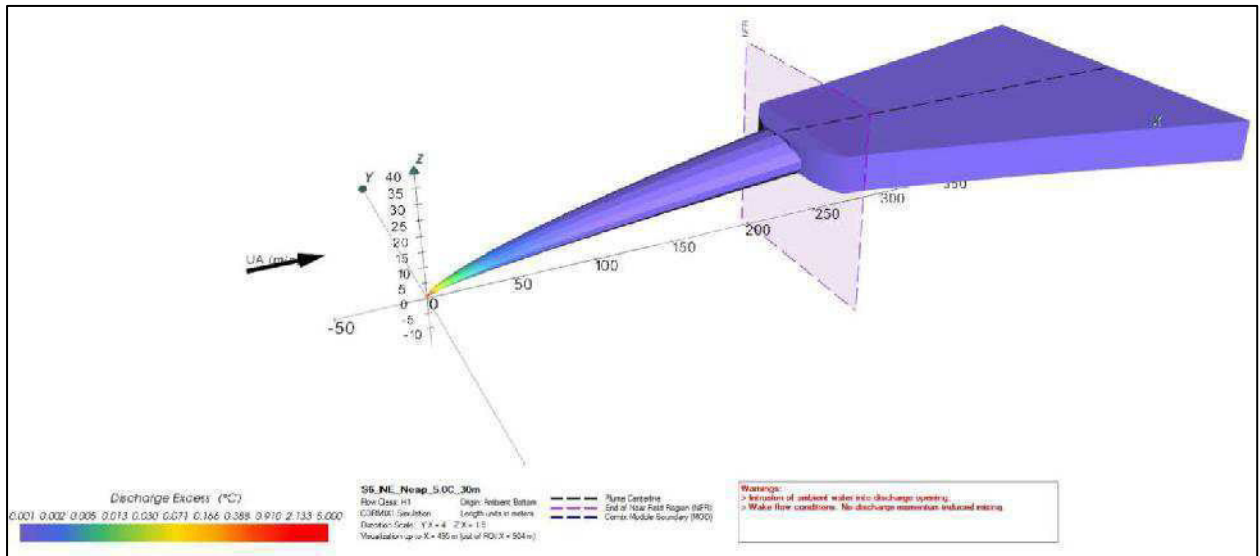


Figure B15: NE\_N\_06\_ (Ex. Temp. = 5°C, Flow Rate=8.28 m<sup>3</sup>/h, Depth=30m)

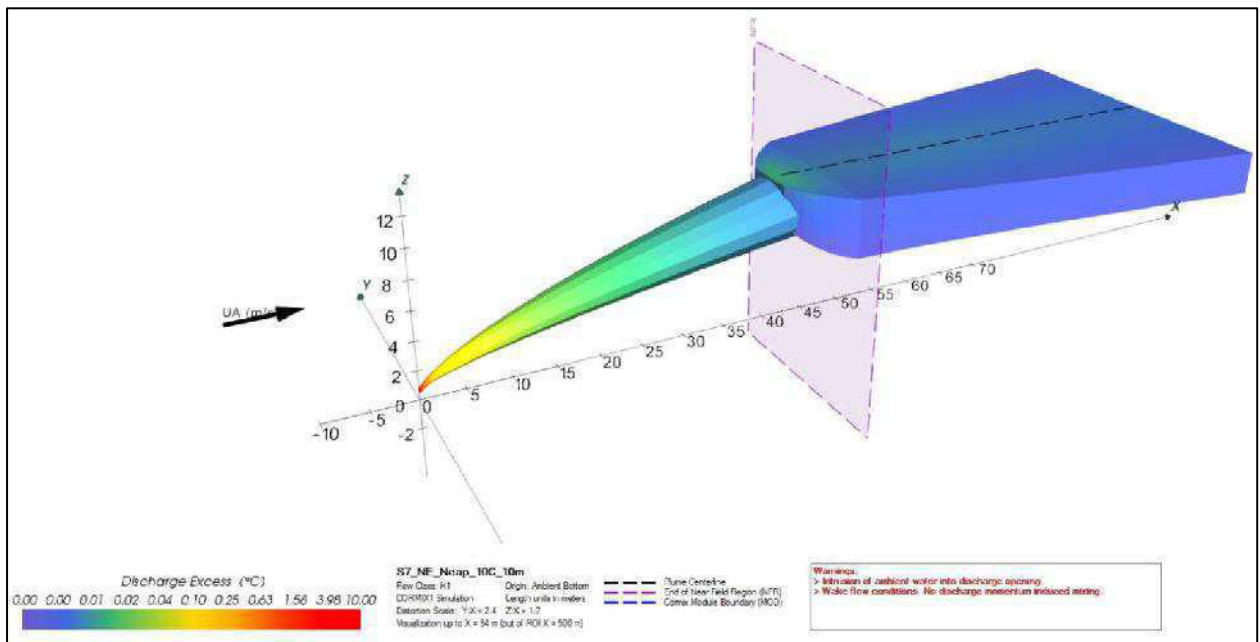


Figure B16: NE\_N\_07\_ (Ex. Temp. = 10°C, Flow Rate=6.21 m<sup>3</sup>/h, Depth=10m)

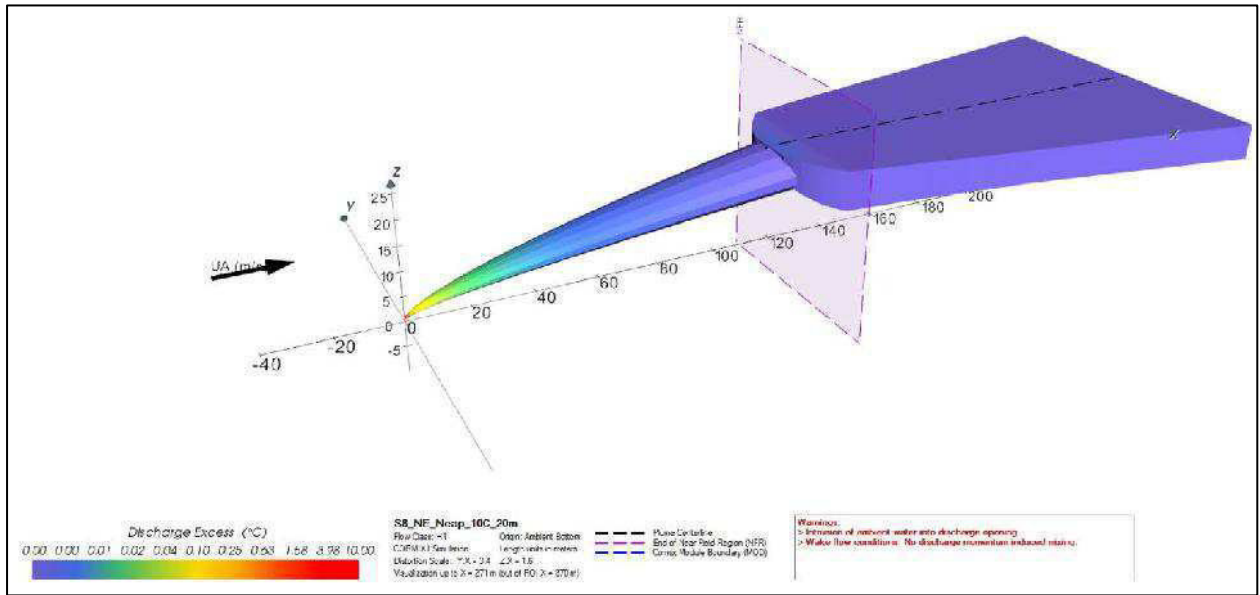


Figure B17: NE\_N\_08\_ (Ex. Temp. = 10°C, Flow Rate=6.21 m<sup>3</sup>/h, Depth=20m)

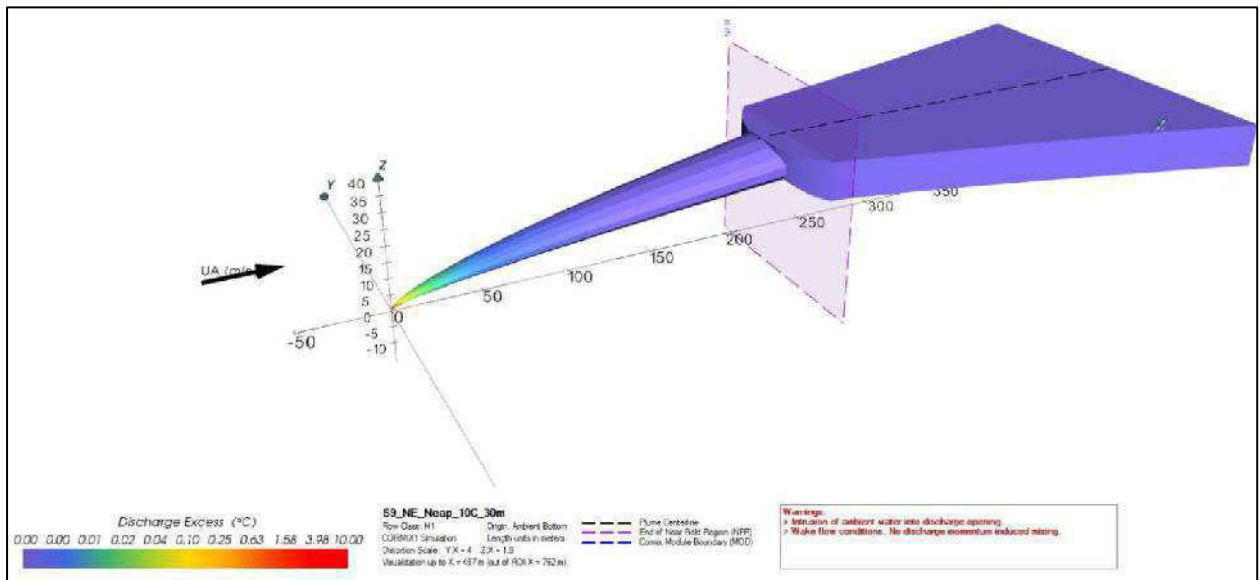


Figure B18: NE\_N\_09\_ (Ex. Temp. = 10°C, Flow Rate=6.21 m<sup>3</sup>/h, Depth=30m)

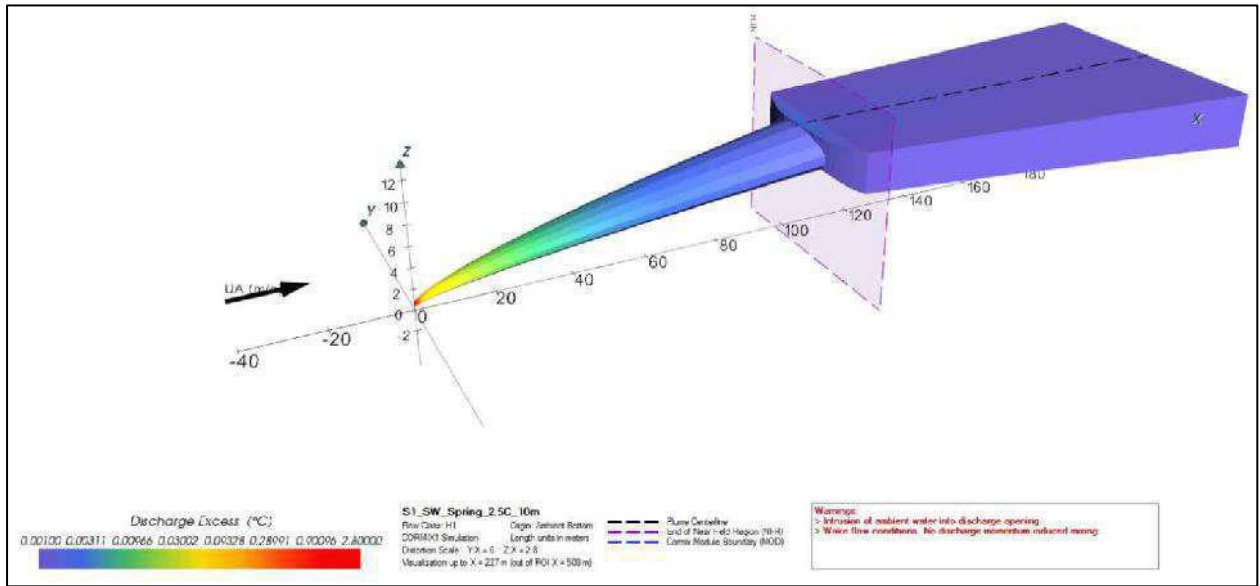


Figure B19: SW\_S\_01\_ (Ex. Temp. = 2.5°C, Flow Rate=16.56 m<sup>3</sup>/h, Depth=10m)

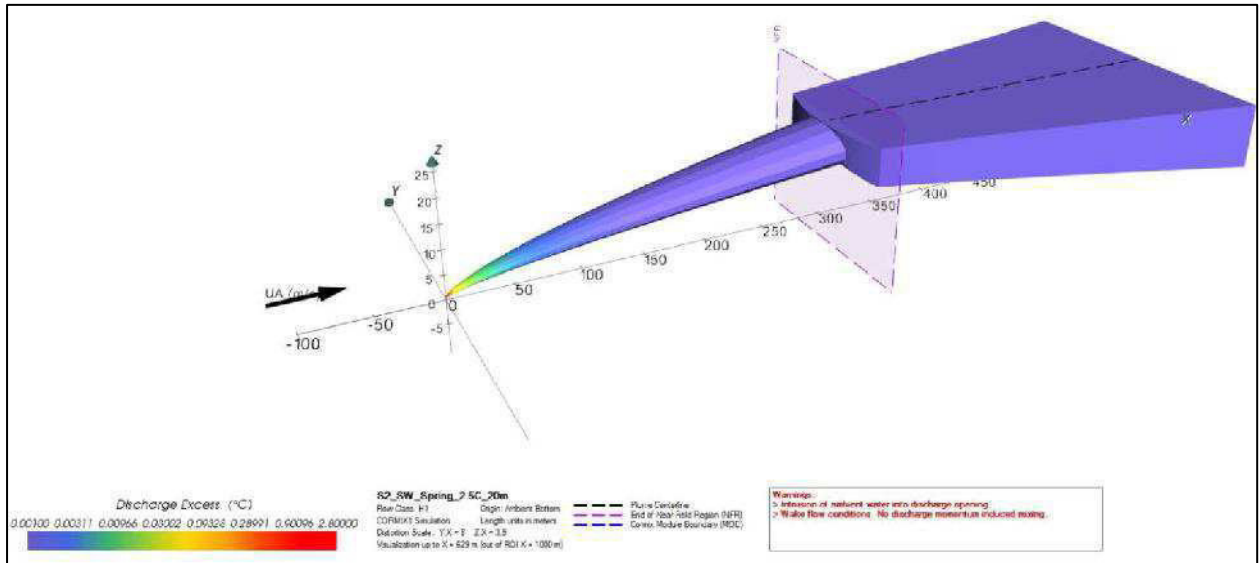


Figure B20: SW\_S\_02\_ (Ex. Temp. = 2.5°C, Flow Rate=16.56 m<sup>3</sup>/h, Depth=20m)



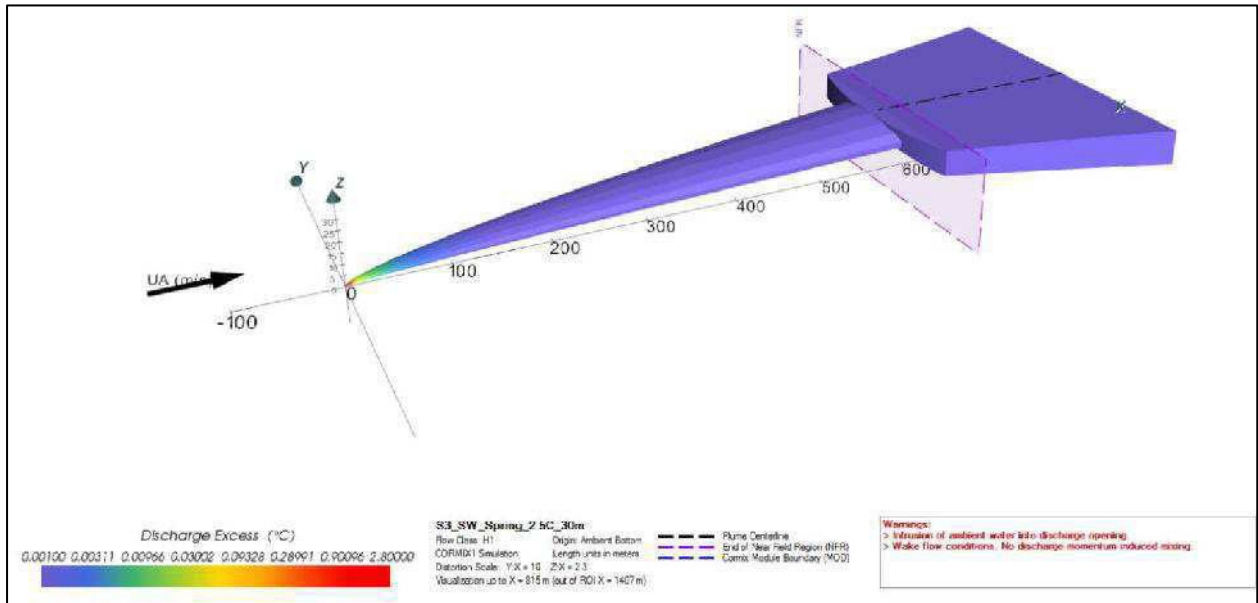


Figure B21: SW\_S\_03\_ (Ex. Temp. = 2.5°C, Flow Rate=16.56 m<sup>3</sup>/h, Depth=30m)

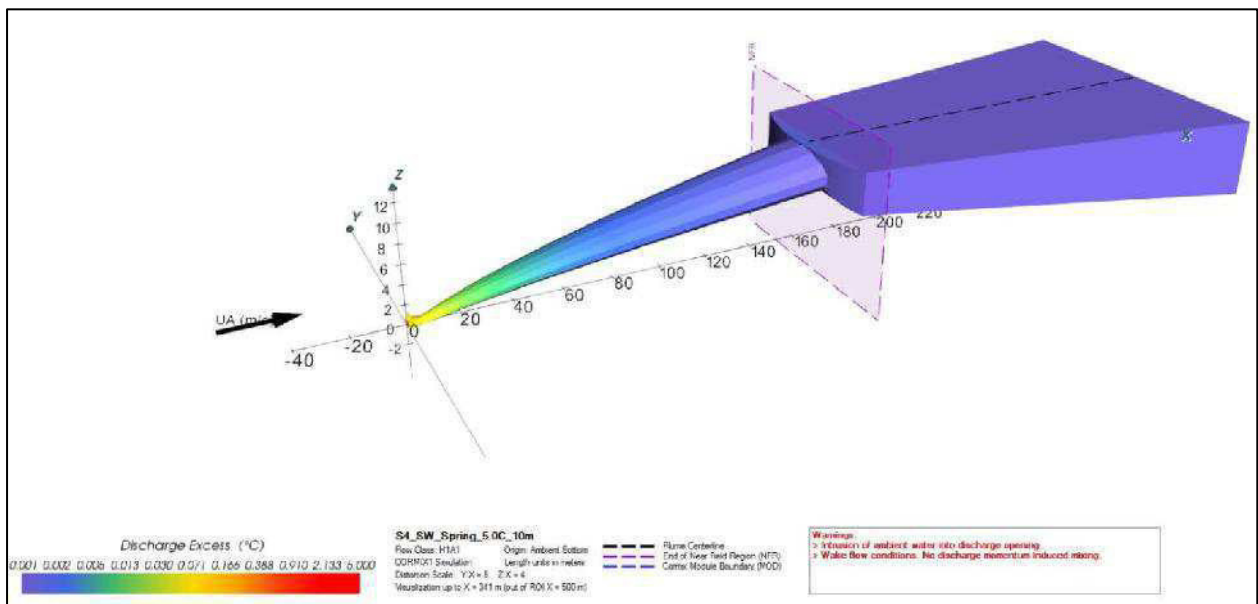


Figure B22: SW\_S\_04\_ (Ex. Temp. = 5°C, Flow Rate=8.28 m<sup>3</sup>/h, Depth=10m)

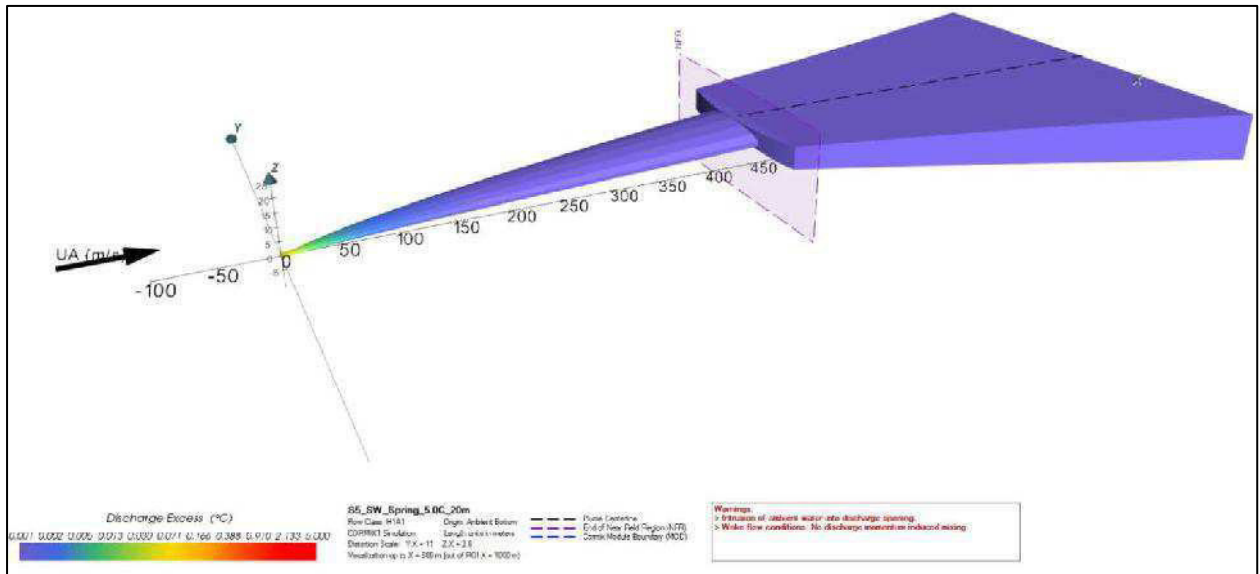


Figure B23: SW\_S\_05\_ (Ex. Temp. = 5°C, Flow Rate=8.28 m<sup>3</sup>/h, Depth=20m)

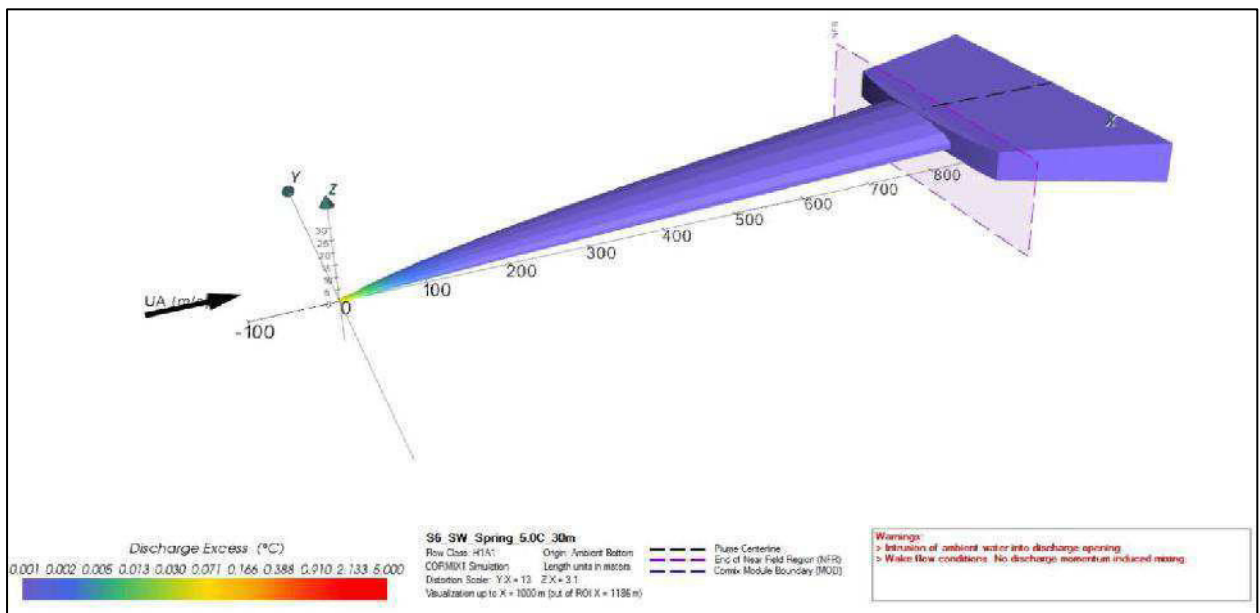


Figure B24: SW\_S\_06\_ (Ex. Temp. = 5°C, Flow Rate=8.28 m<sup>3</sup>/h, Depth=30m)

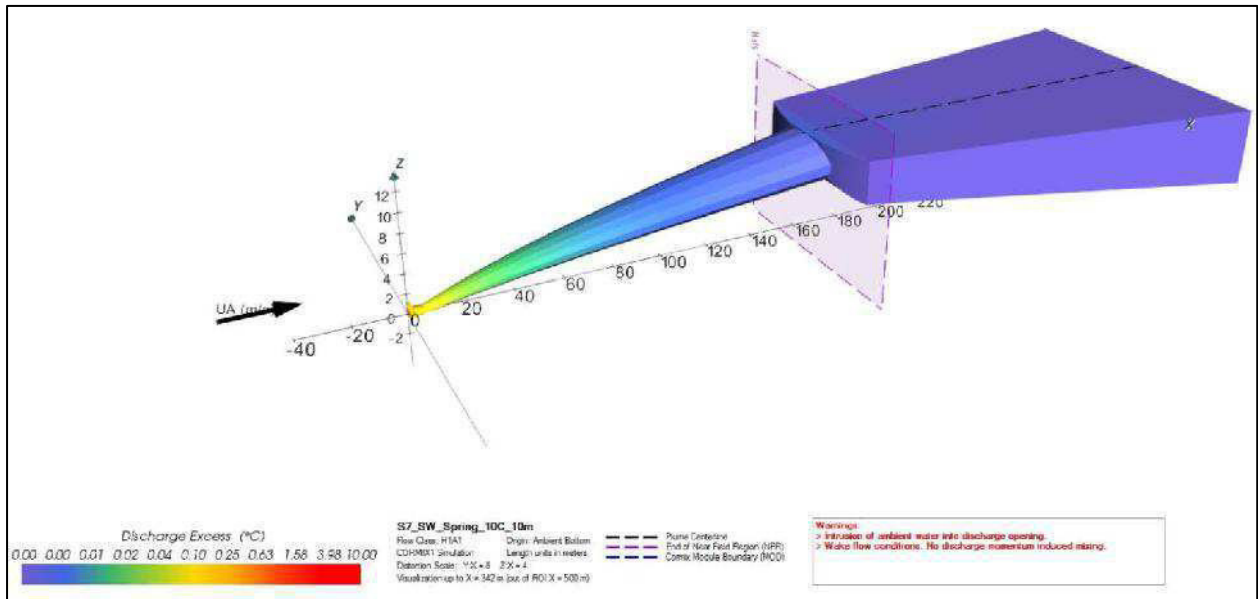


Figure B25: SW\_S\_07\_ (Ex. Temp. = 10°C, Flow Rate=6.21 m<sup>3</sup>/h, Depth=10m)

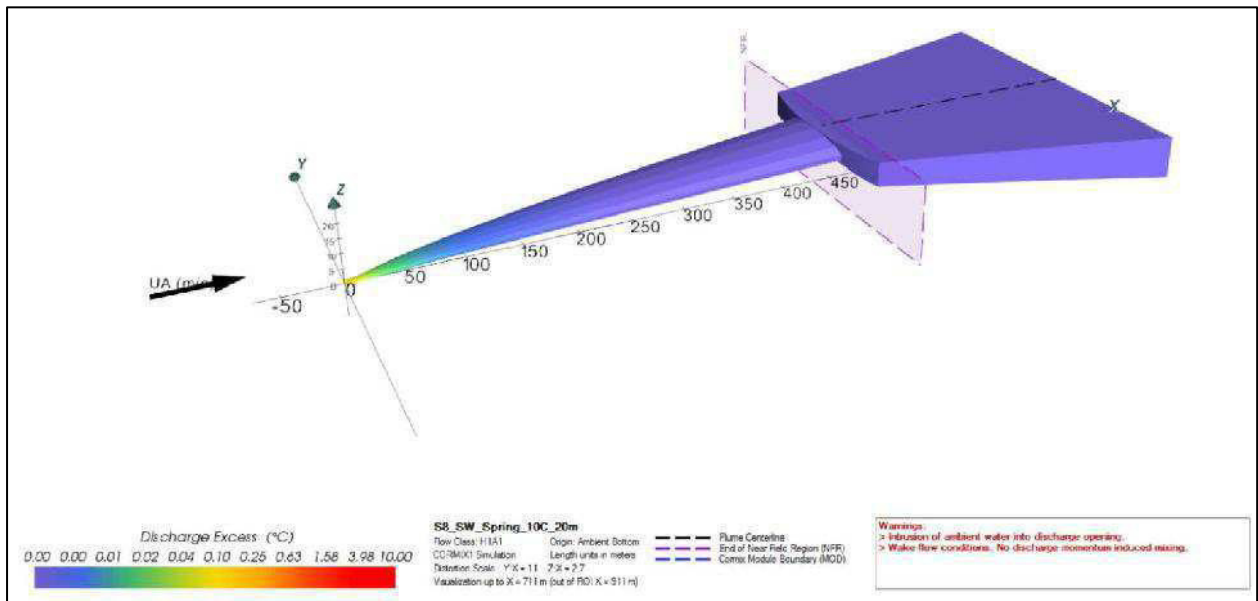


Figure B26: SW\_S\_08\_ (Ex. Temp. = 10°C, Flow Rate=6.21 m<sup>3</sup>/h, Depth=20m)

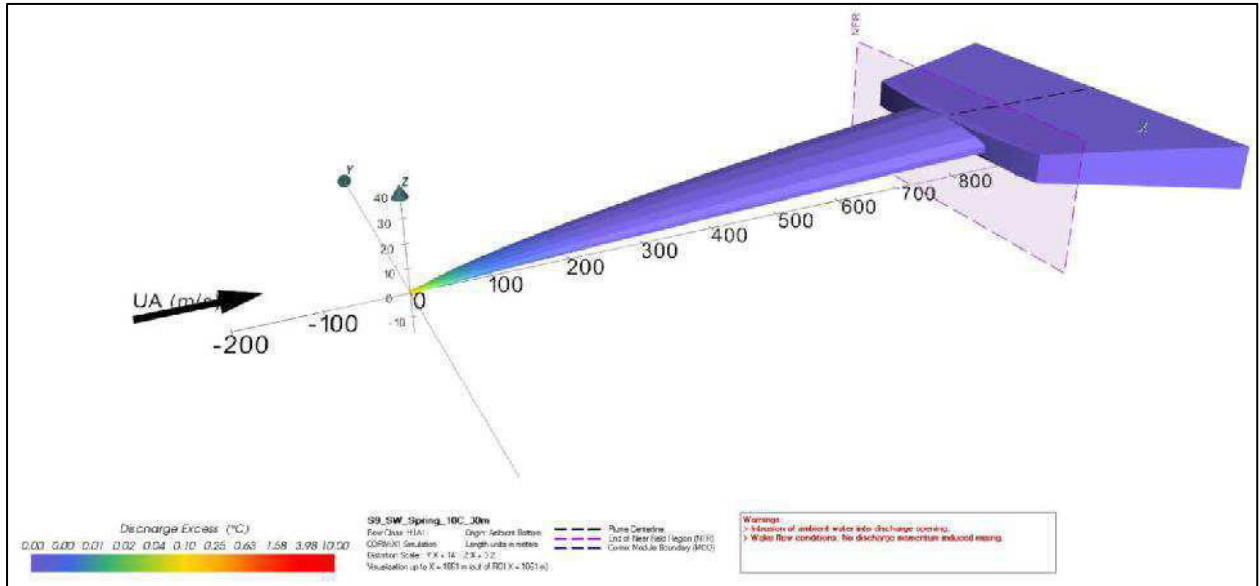


Figure B27: SW\_S\_09\_ (Ex. Temp. = 10°C, Flow Rate=6.21 m<sup>3</sup>/h, Depth=30m)

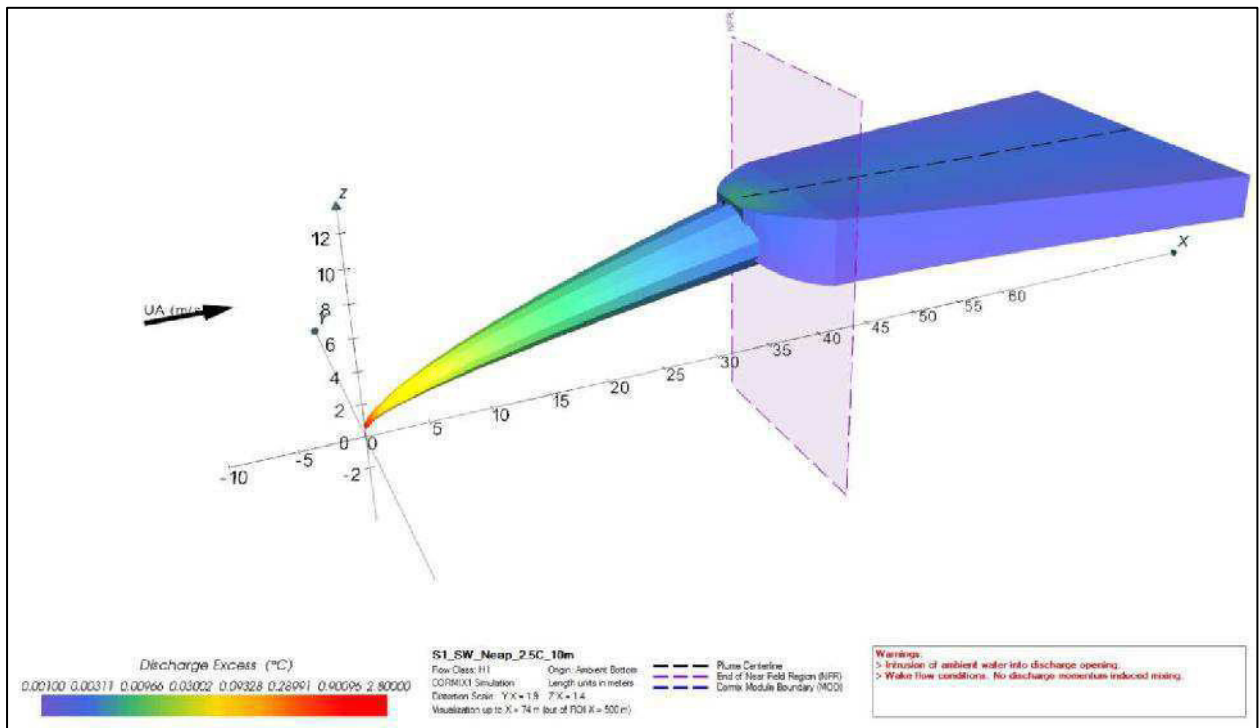


Figure B28: SW\_N\_01\_ (Ex. Temp. = 2.5°C, Flow Rate=16.56 m<sup>3</sup>/h, Depth=10m)

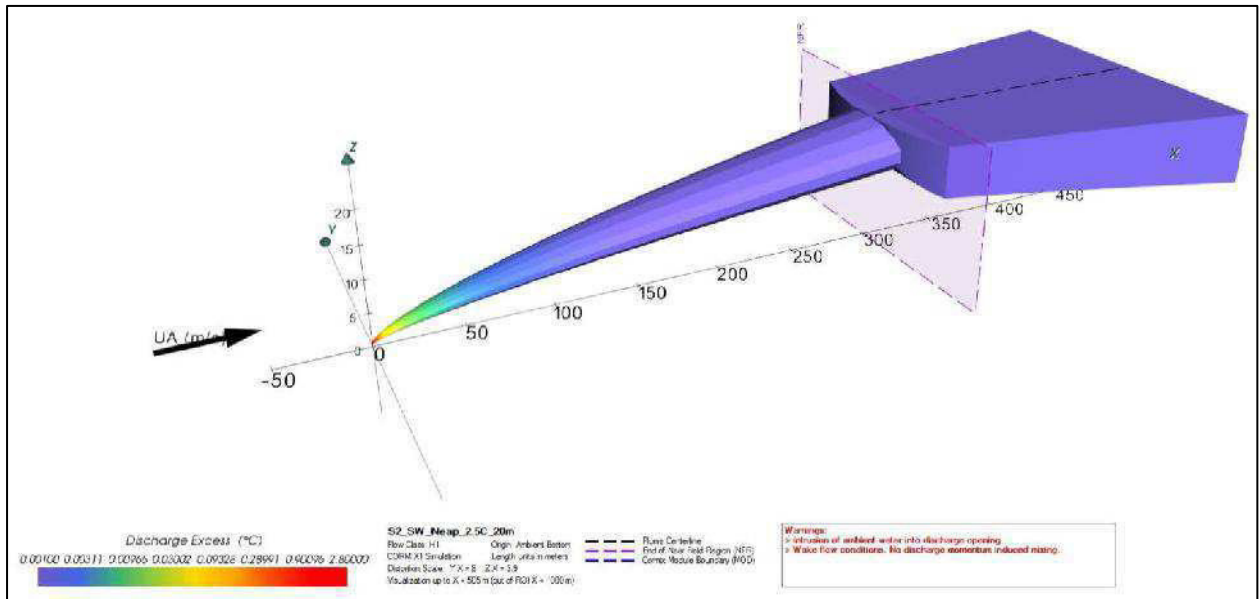


Figure B29: SW\_N\_02\_ (Ex. Temp. = 2.5°C, Flow Rate=16.56 m<sup>3</sup>/h, Depth=20m)

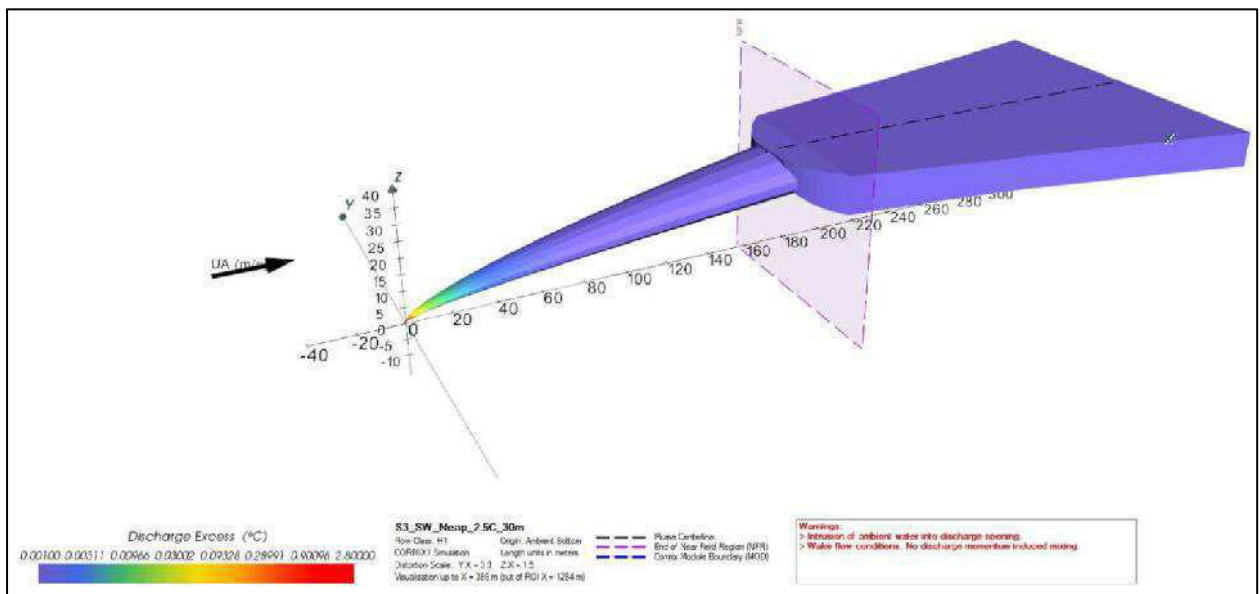


Figure B30: SW\_N\_03\_ (Ex. Temp. = 2.5°C, Flow Rate=16.56 m<sup>3</sup>/h, Depth=30m)

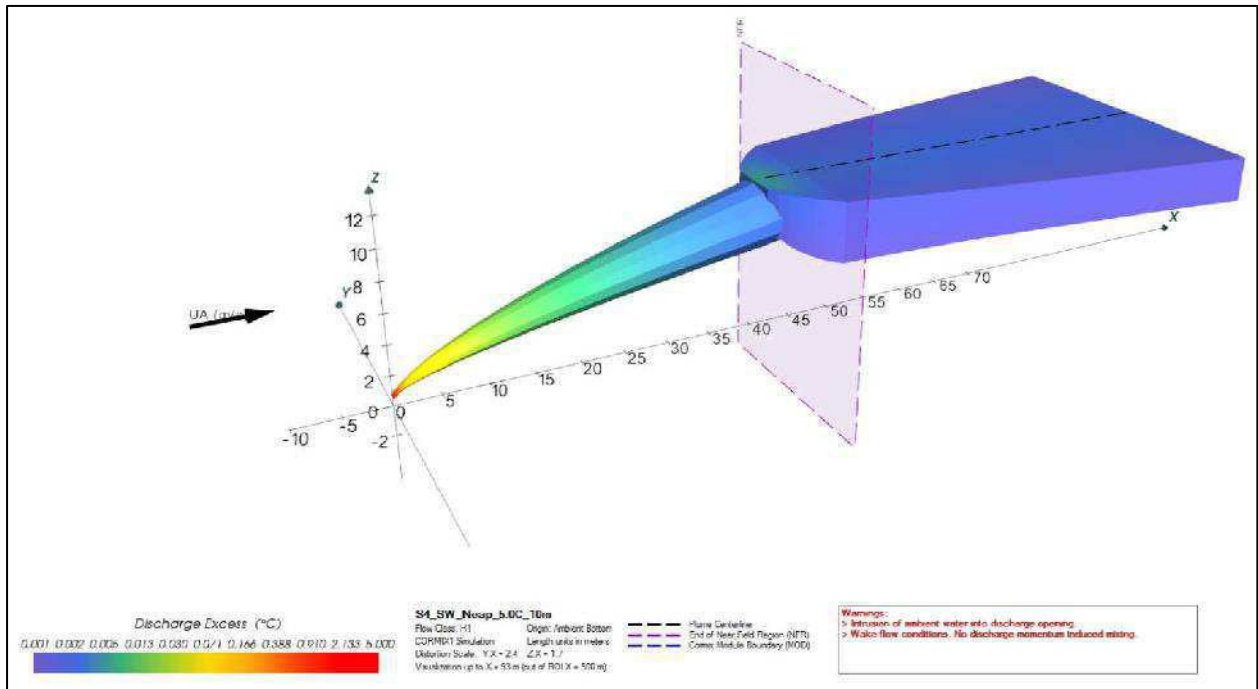


Figure B31: SW\_N\_04\_ (Ex. Temp. = 5°C, Flow Rate=8.28 m<sup>3</sup>/h, Depth=10m)

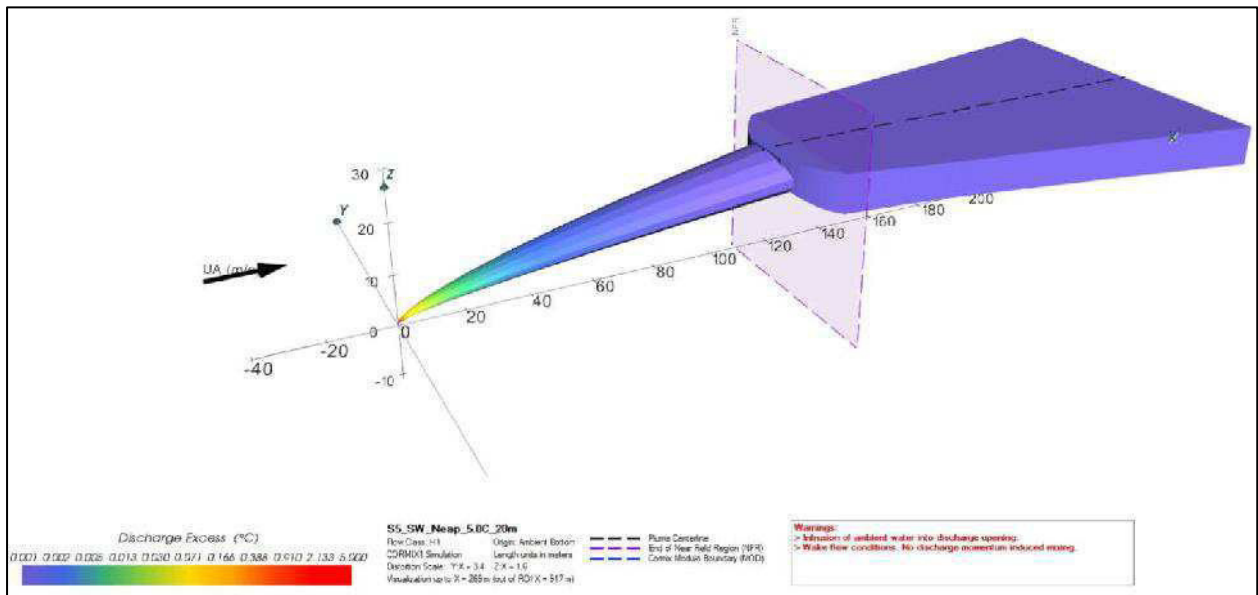


Figure B32: SW\_N\_05\_ (Ex. Temp. = 5°C, Flow Rate=8.28 m<sup>3</sup>/h, Depth=20m)

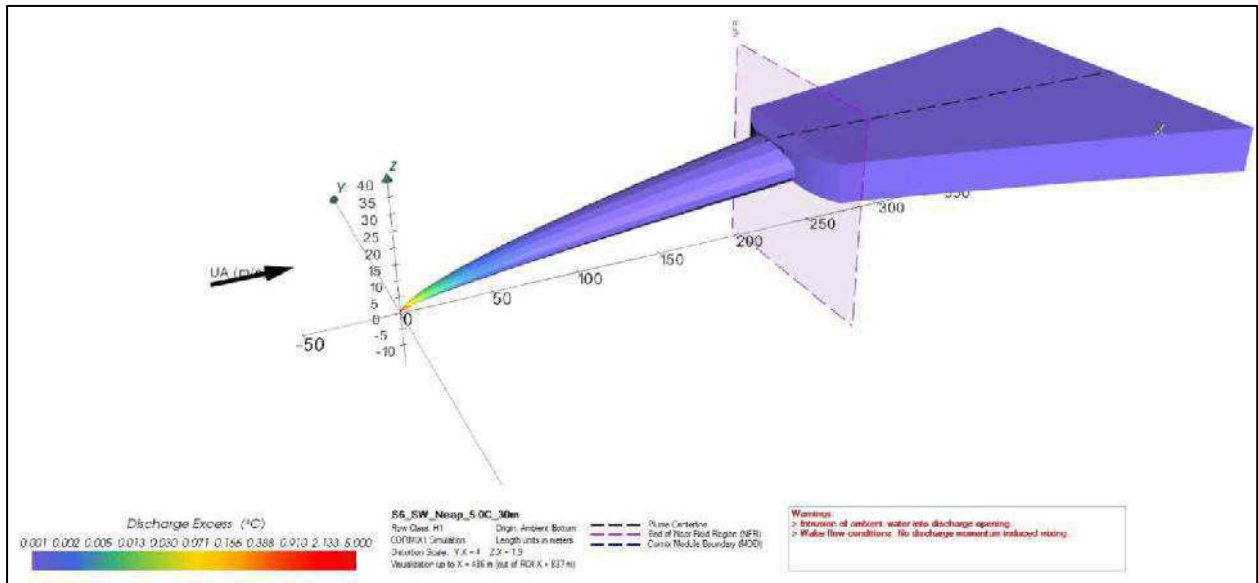


Figure B33: SW\_N\_06\_ (Ex. Temp. = 5°C, Flow Rate=8.28 m<sup>3</sup>/h, Depth=30m)

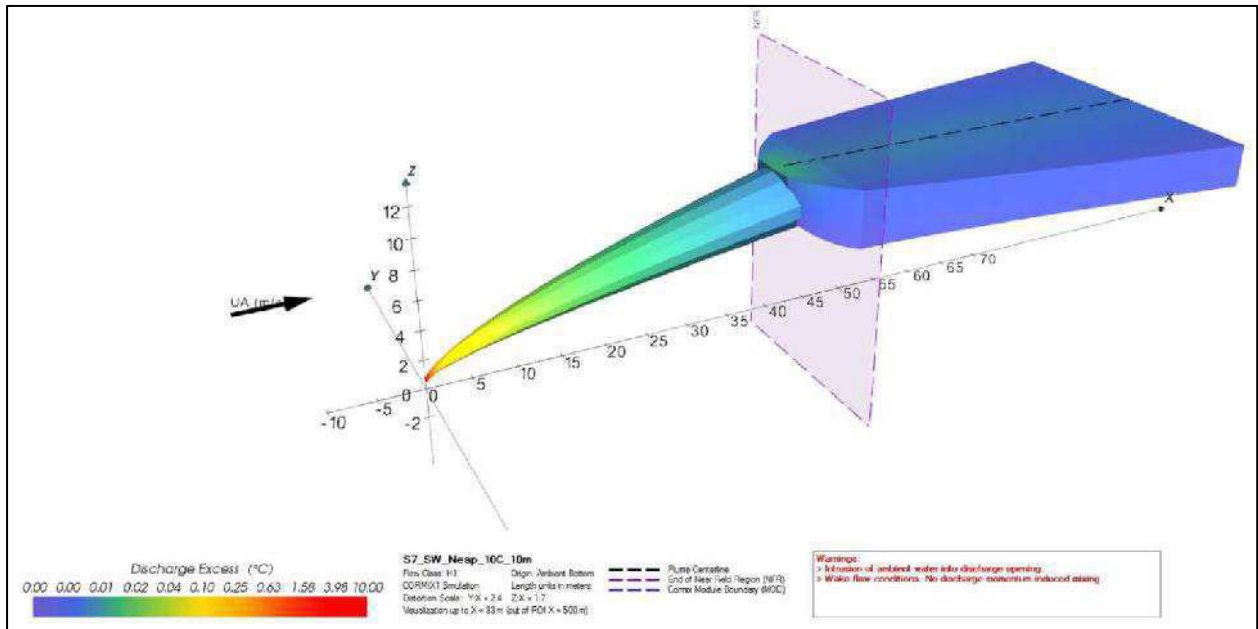


Figure B34: SW\_N\_07\_ (Ex. Temp. = 10°C, Flow Rate=6.21 m<sup>3</sup>/h, Depth=10m)

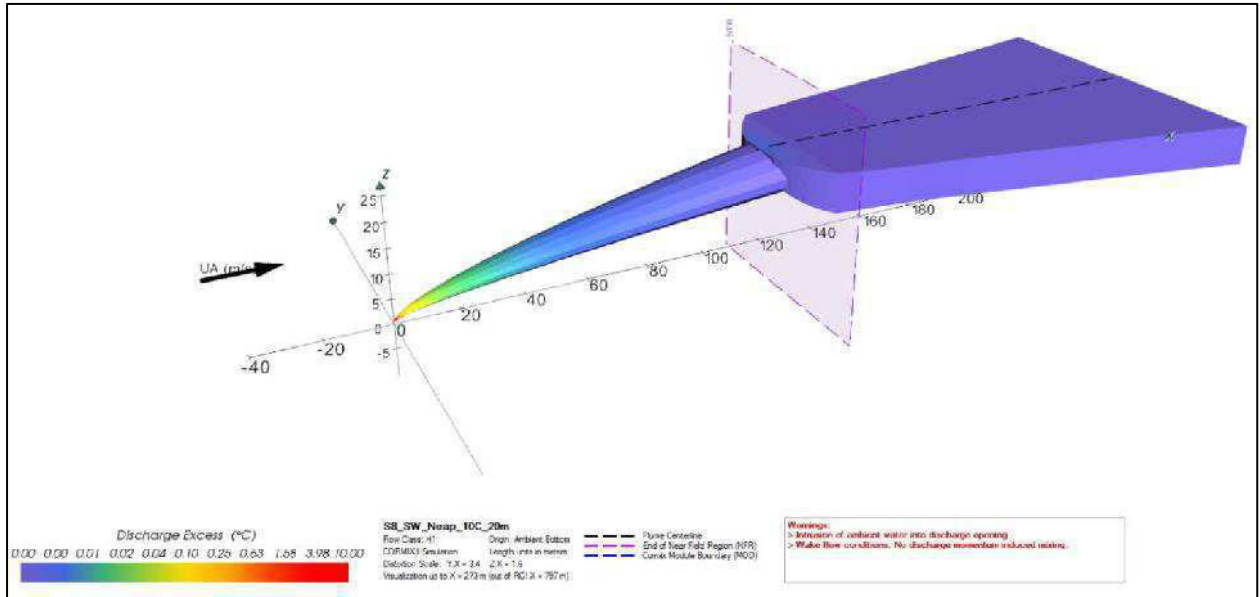


Figure B35: SW\_N\_08\_ (Ex. Temp. = 10°C, Flow Rate=6.21 m<sup>3</sup>/h, Depth=20m)

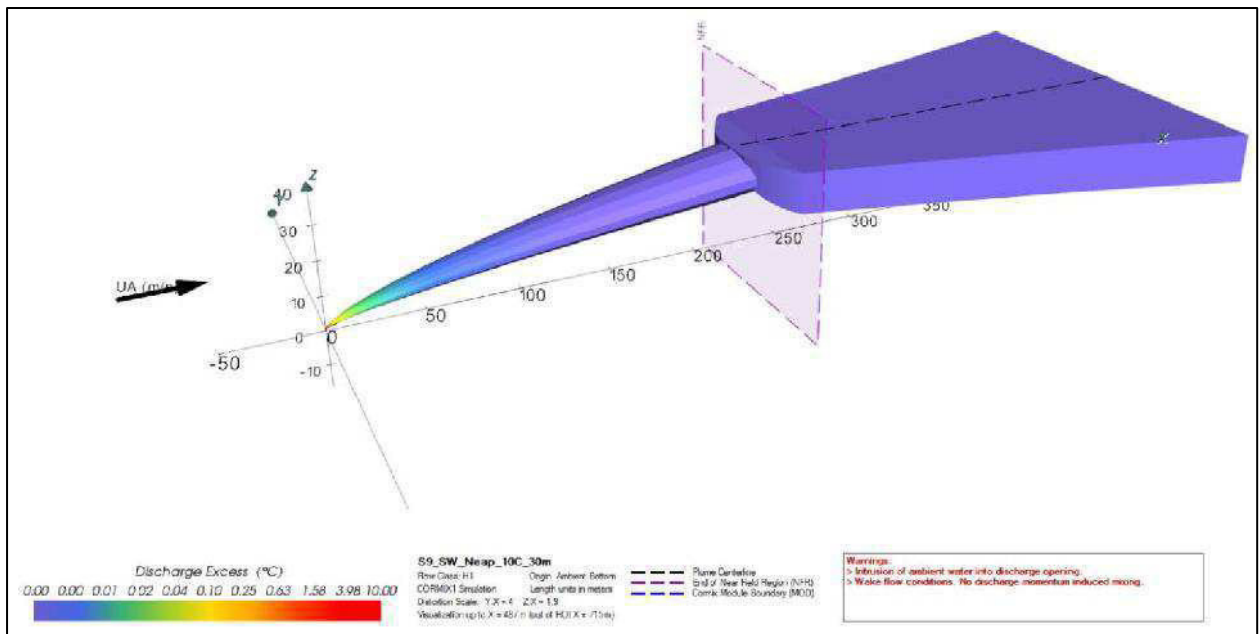


Figure B36: SW\_N\_09\_ (Ex. Temp. = 10°C, Flow Rate=6.21 m<sup>3</sup>/h, Depth=30m)



## **ANNEX C**

### **Heat Dissipation in Far Field (MIKE 21 HD)**

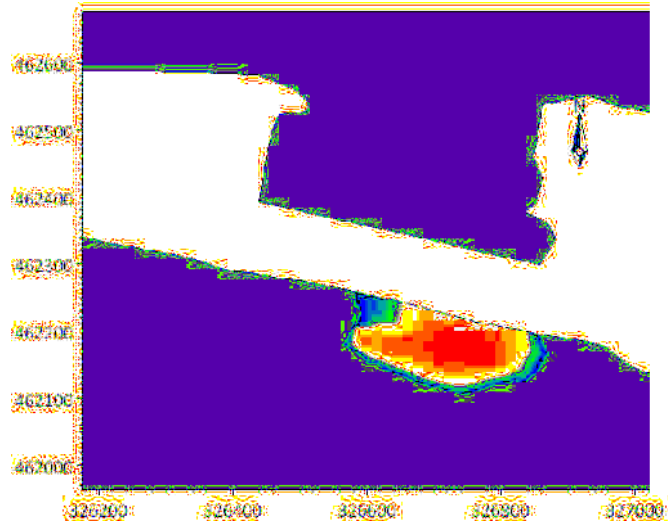


Figure C.01: NE\_S\_01\_Eastward Flow

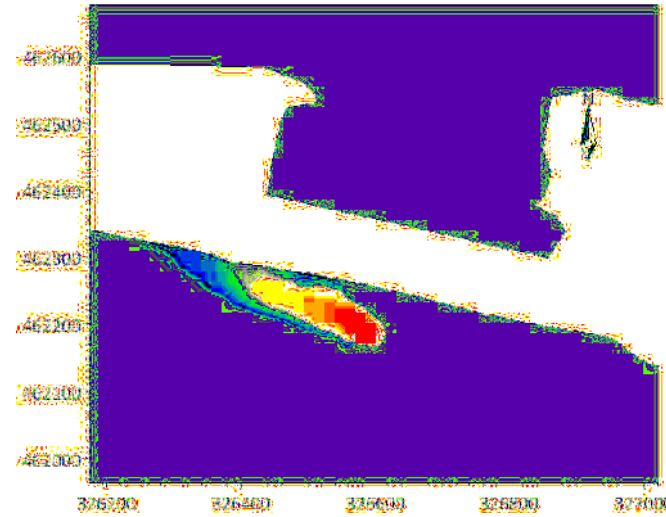


Figure C.02: NE\_S\_01\_Westward Flow

Excess Temperature [deg C]

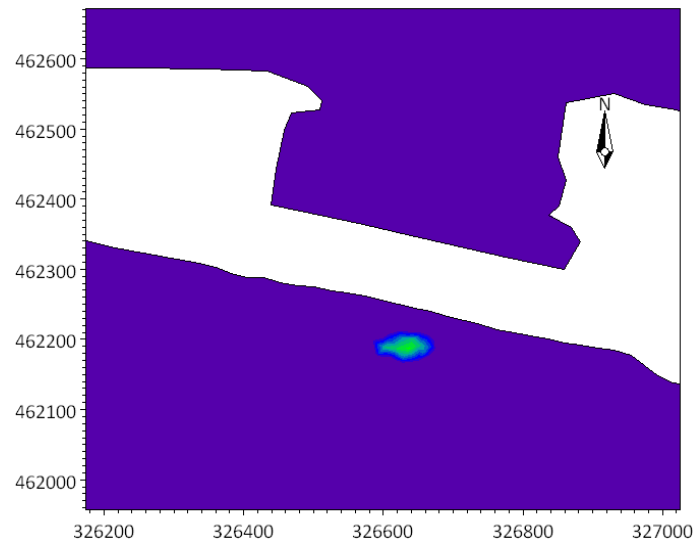
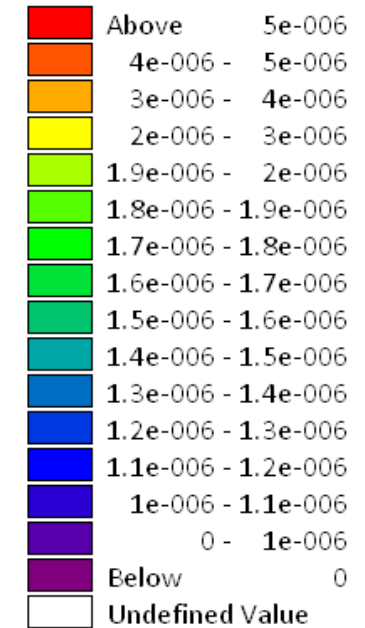


Figure C.03: NE\_S\_02\_Eastward Flow

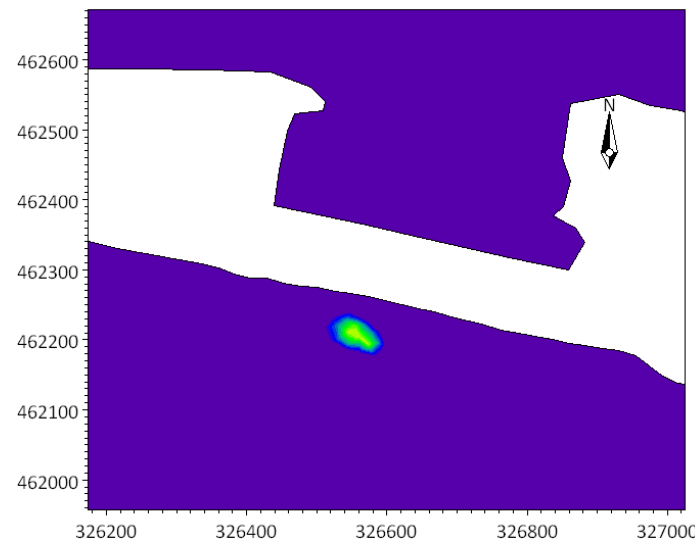


Figure C.04: NE\_S\_02\_Westward Flow

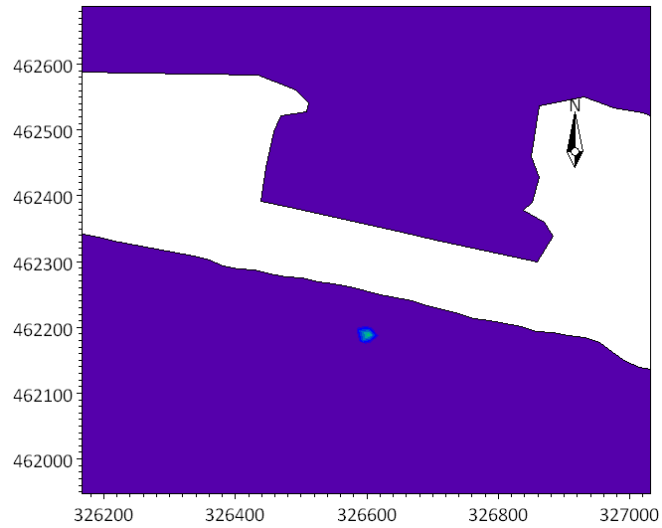


Figure C.05: NE\_S\_03\_Eastward Flow

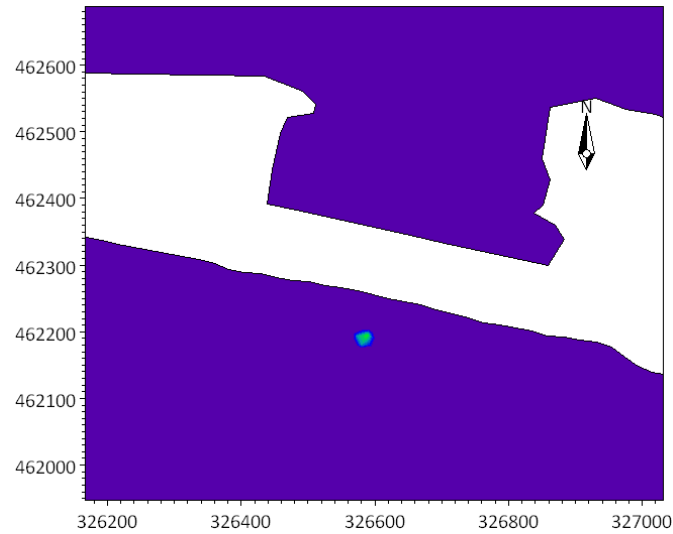


Figure C.06: NE\_S\_03\_Westward Flow

Excess Temperature [deg C]

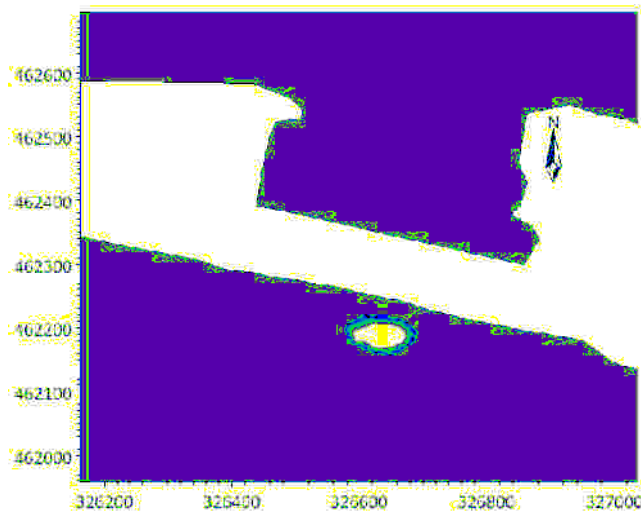
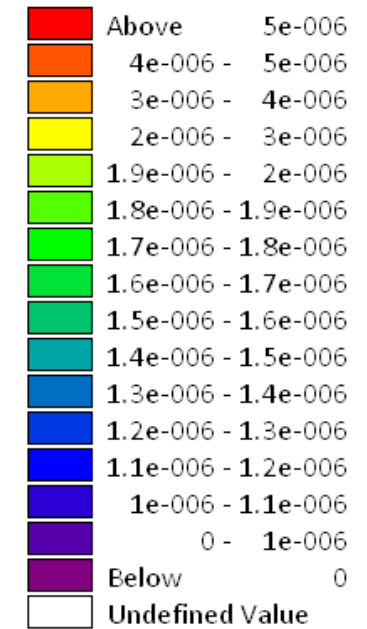


Figure C.07: NE\_S\_04\_Eastward Flow

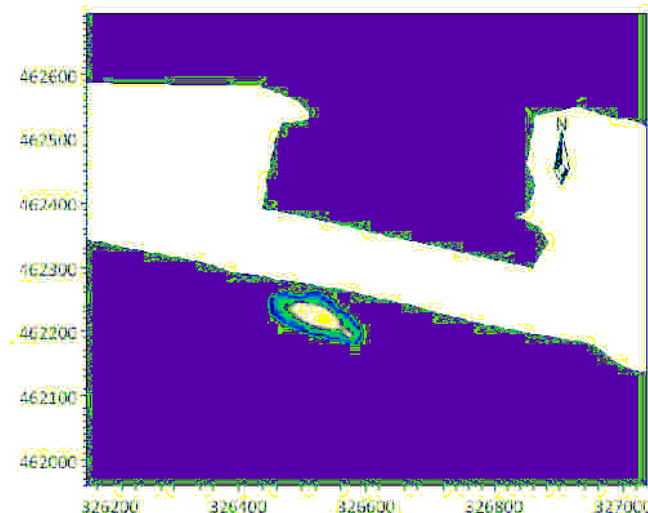


Figure C.08: NE\_S\_04\_Westward Flow

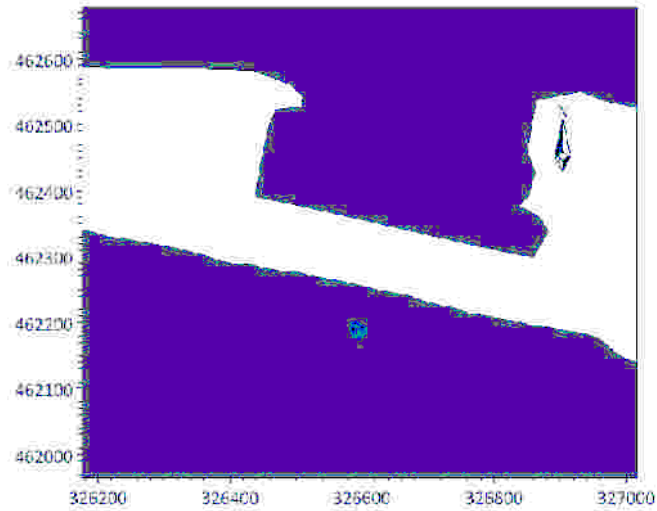


Figure C.09: NE\_S\_05\_Eastward Flow

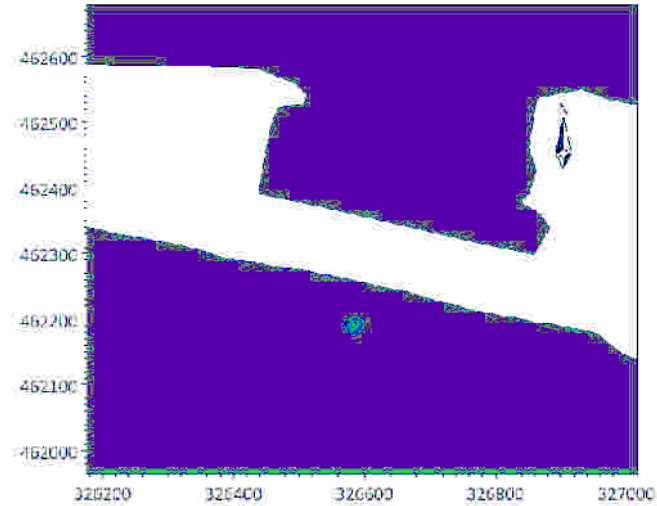


Figure C.10: NE\_S\_05\_Westward Flow

Excess Temperature [deg C]

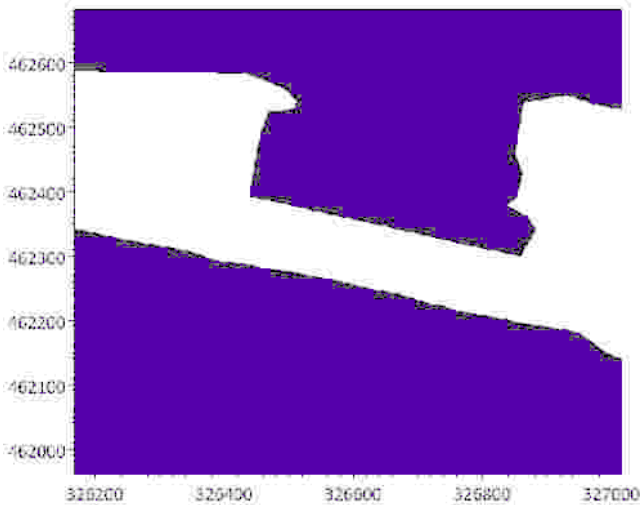
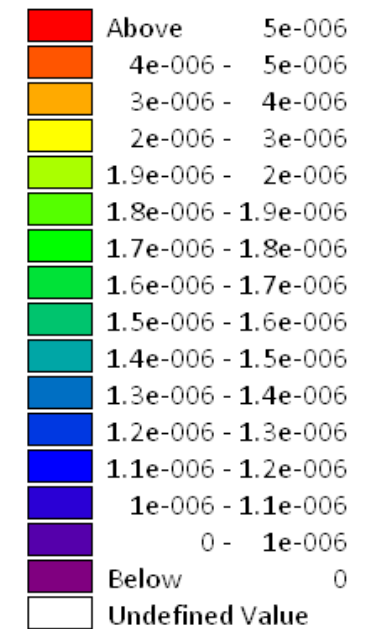


Figure C.11: NE\_S\_06\_Eastward Flow

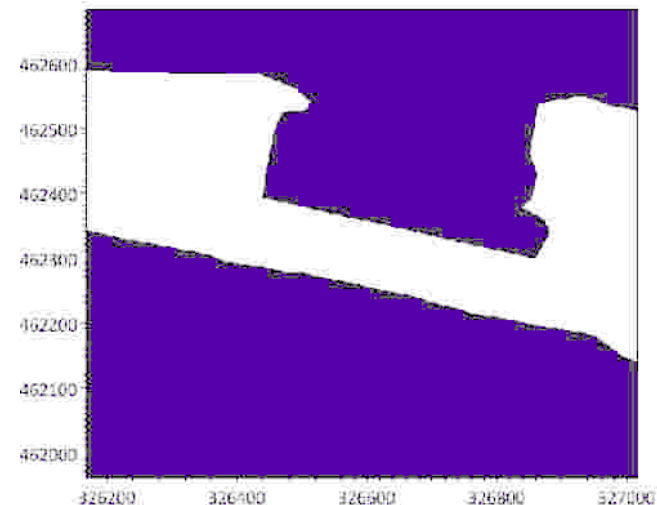


Figure C.12: NE\_S\_06\_Westward Flow

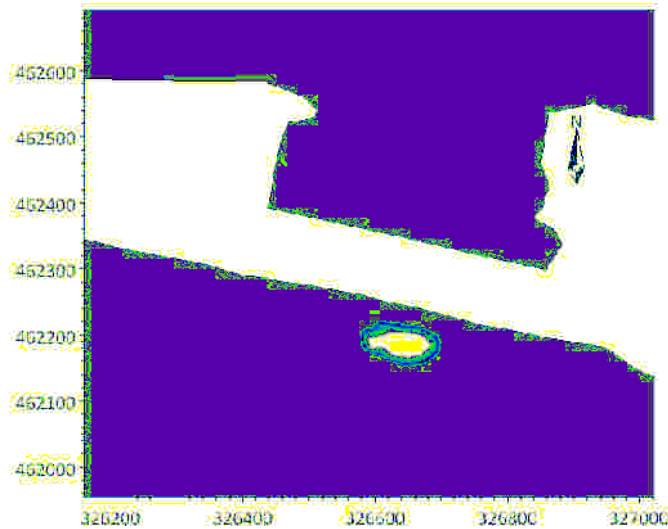


Figure C.13: NE\_S\_07\_Eastward Flow

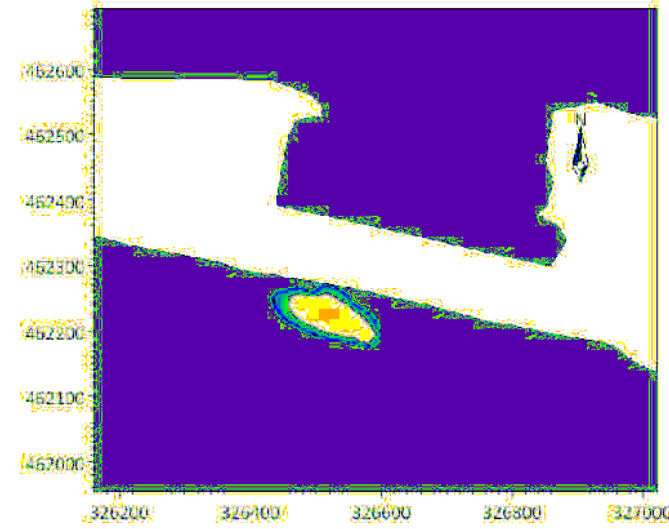


Figure C.14: NE\_S\_07\_Westward Flow

Excess Temperature [deg C]

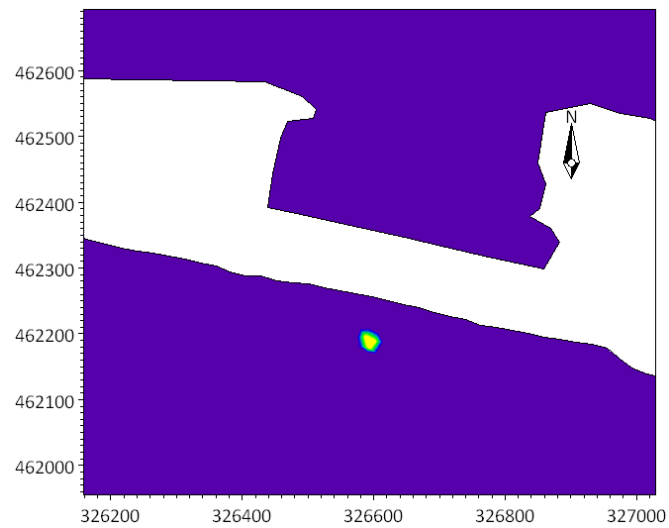
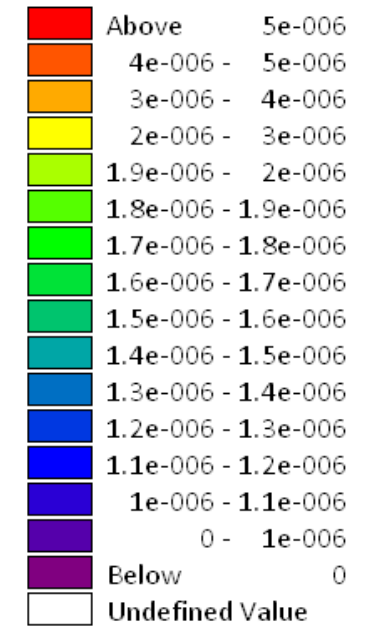


Figure C.15: NE\_S\_08\_Eastward Flow

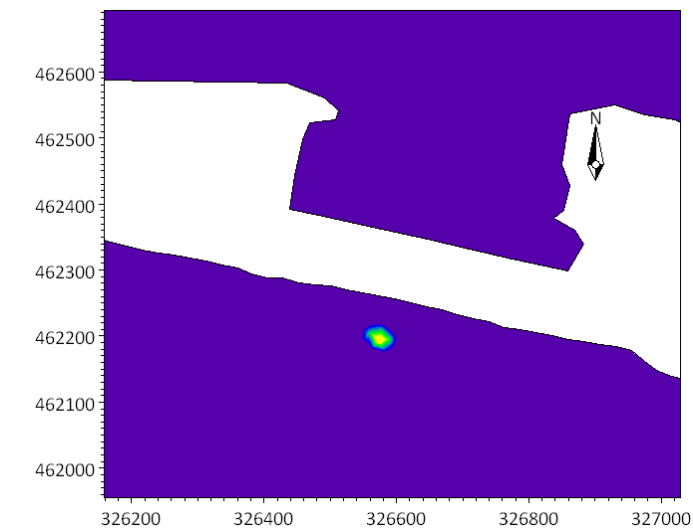


Figure C.16: NE\_S\_08\_Westward Flow

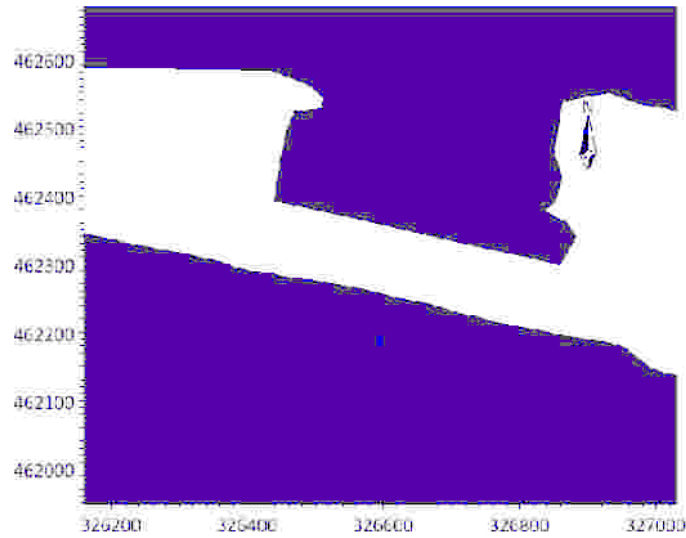


Figure C.17: NE\_S\_09\_Eastward Flow

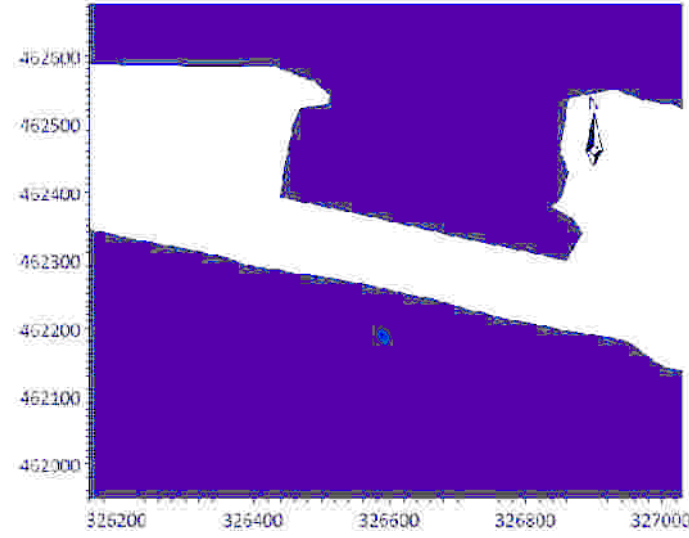


Figure C.18: NE\_S\_09\_Westward Flow

Excess Temperature [deg C]

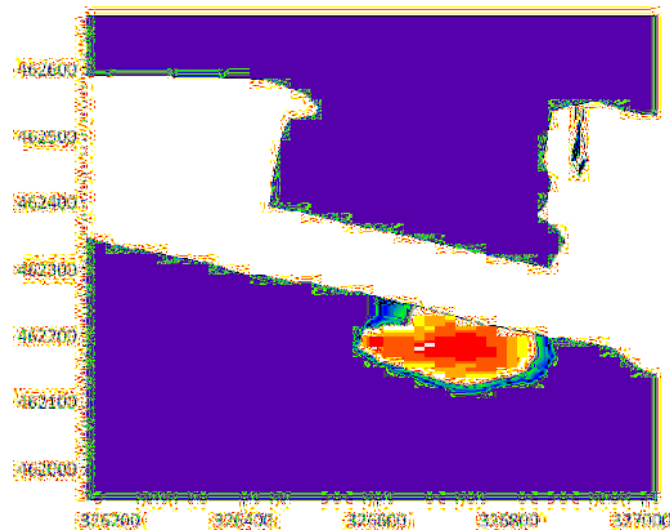
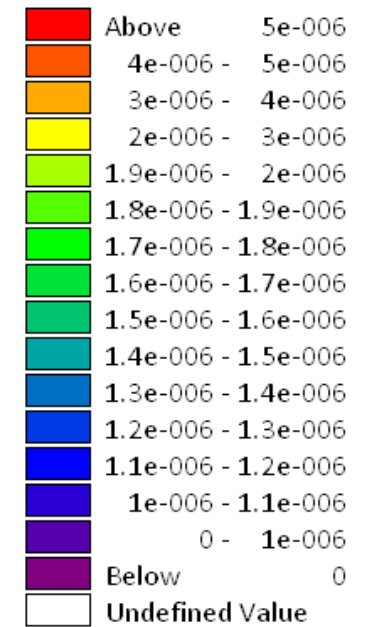


Figure C.19: NE\_N\_01\_Eastward Flow

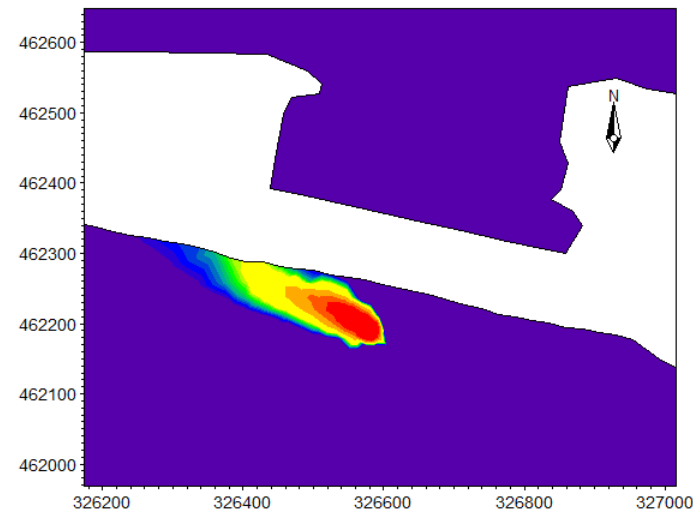


Figure C.20: NE\_N\_01\_Westward Flow

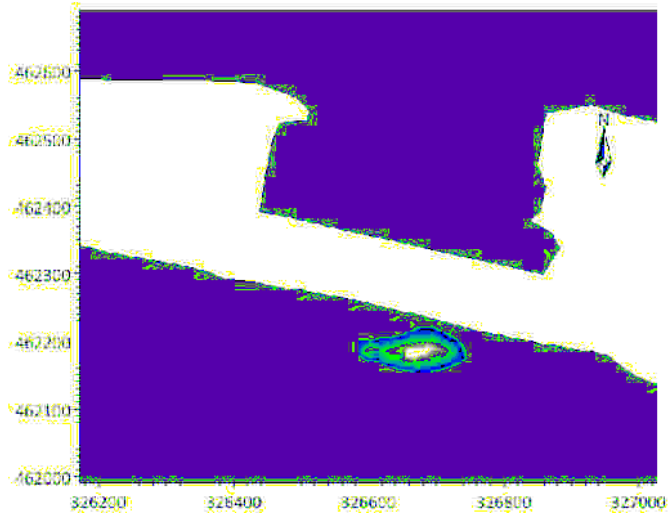


Figure C.21: NE\_N\_02\_Eastward Flow

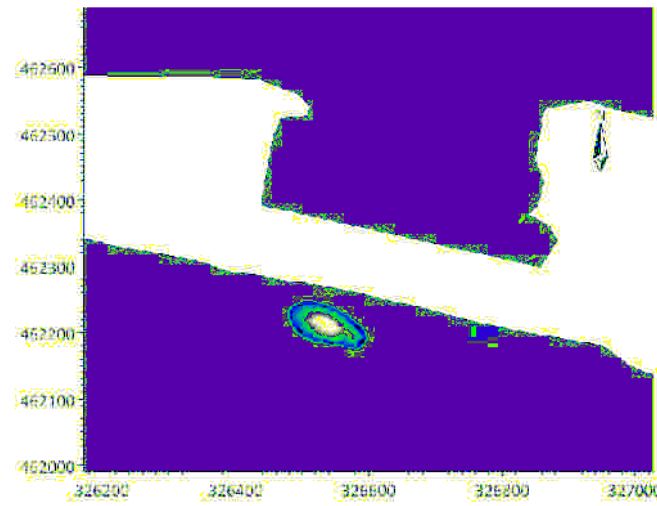


Figure C.22: SW\_N\_02\_Westward Flow

Excess Temperature [deg C]

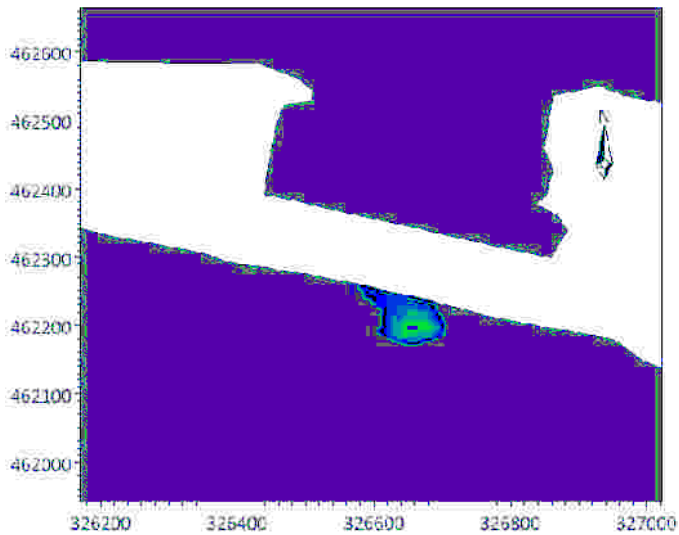
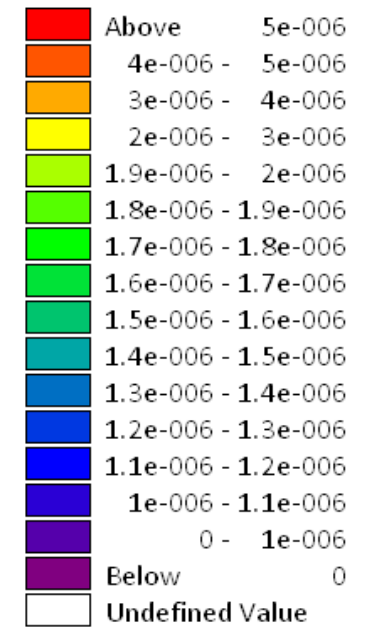


Figure C.23: NE\_N\_03\_Eastward Flow

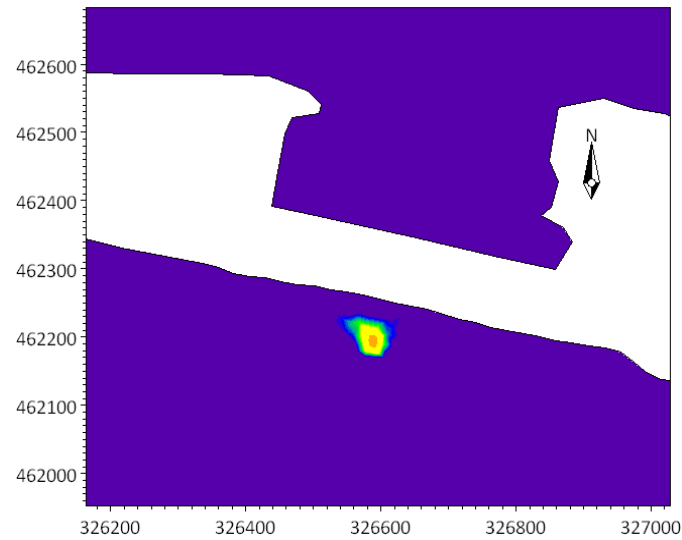


Figure C.24: NE\_N\_03\_Westward Flow

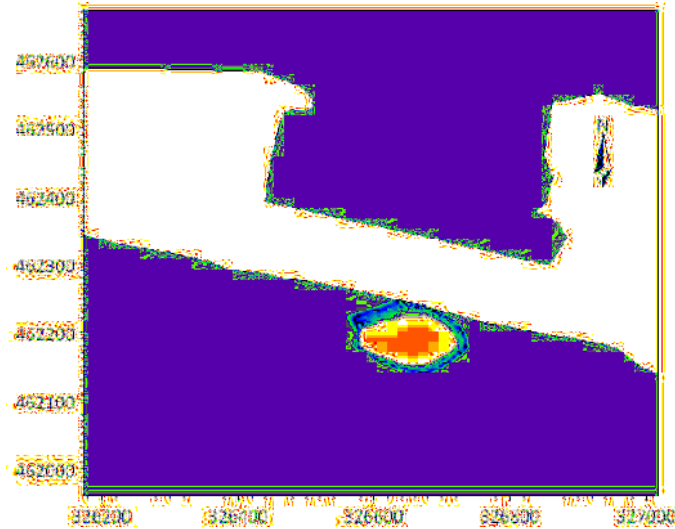


Figure C.25: NE\_N\_04\_Eastward Flow

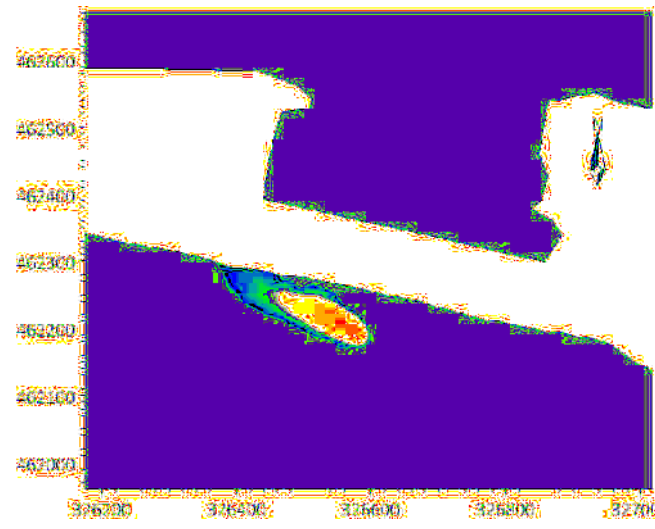


Figure C.26: SW\_N\_04\_Westward Flow

Excess Temperature [deg C]

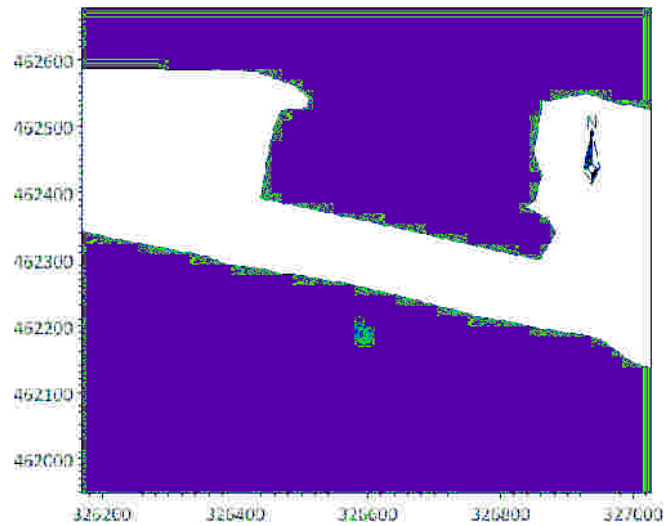
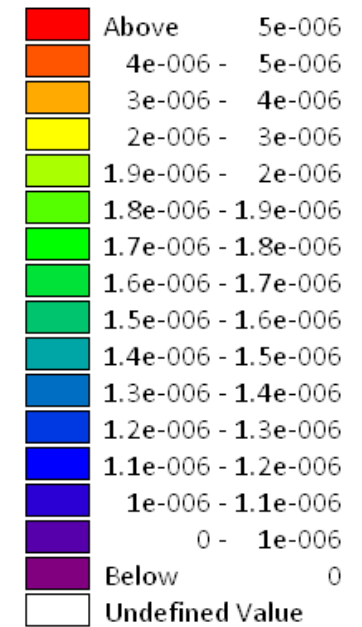


Figure C.27: NE\_N\_05\_Eastward Flow

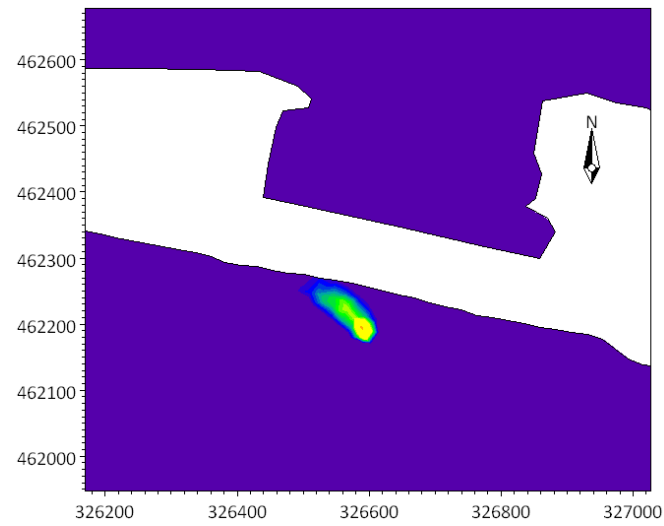


Figure C.28: NE\_N\_05\_Westward Flow



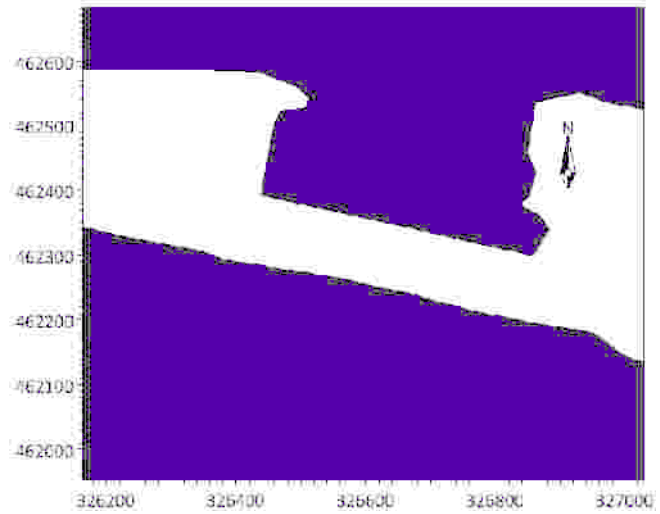


Figure C.29: NE\_N\_06\_Eastward Flow

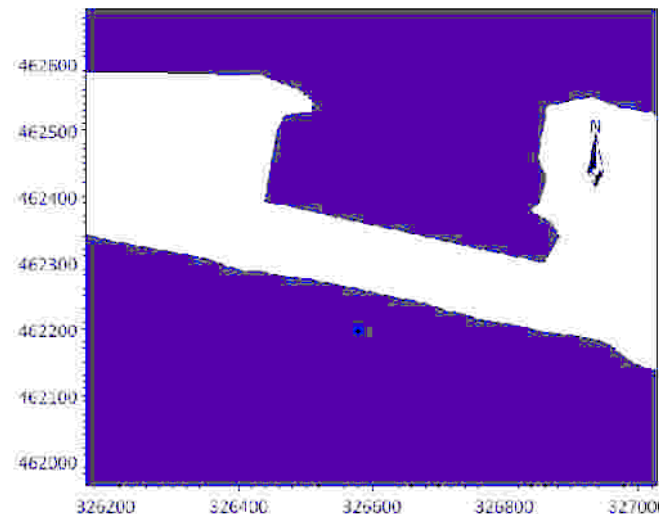


Figure C.30: NE\_N\_06\_Westward Flow

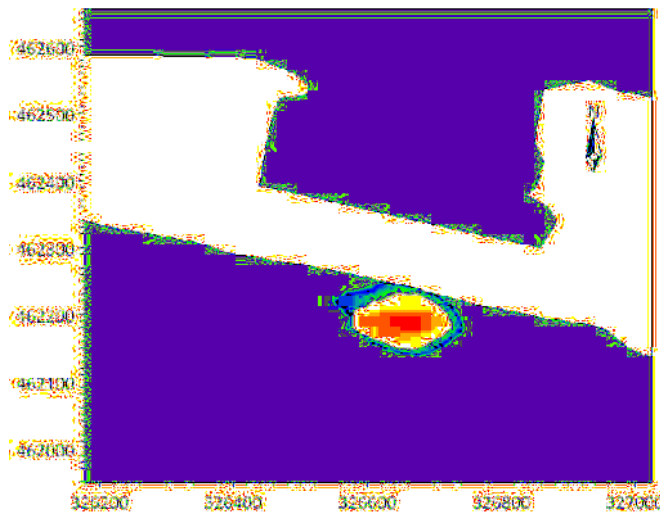
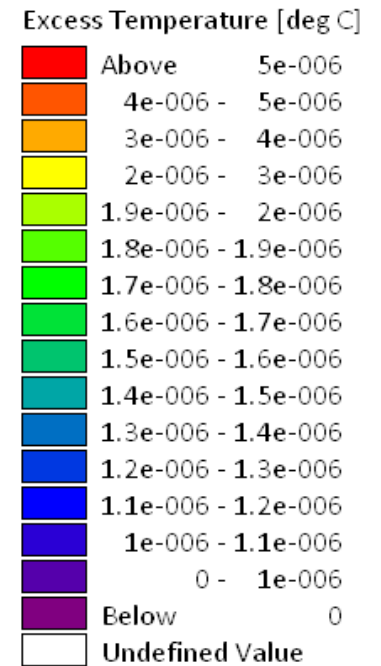


Figure C.31: NE\_N\_07\_Eastward Flow

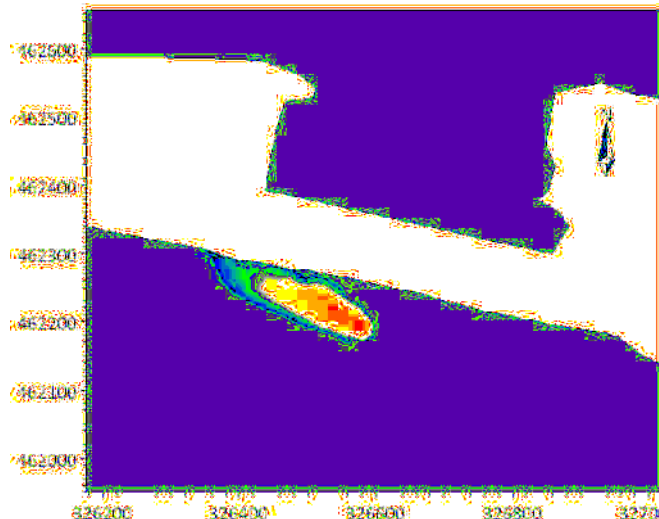


Figure C.32: NE\_N\_07\_Westward Flow

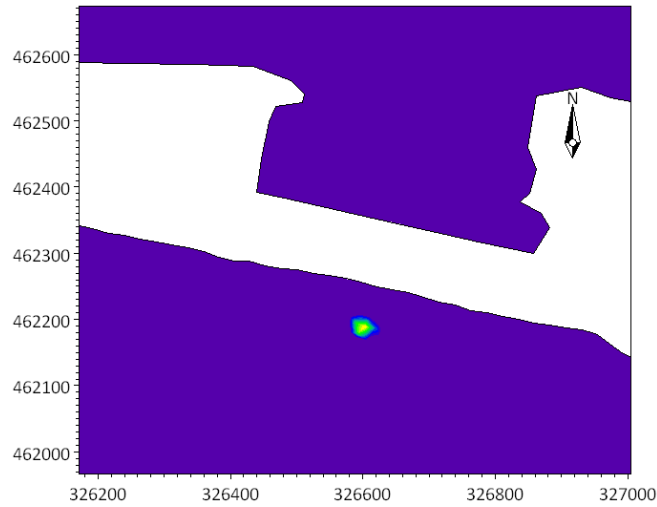


Figure C.33: NE\_N\_08\_Eastward Flow

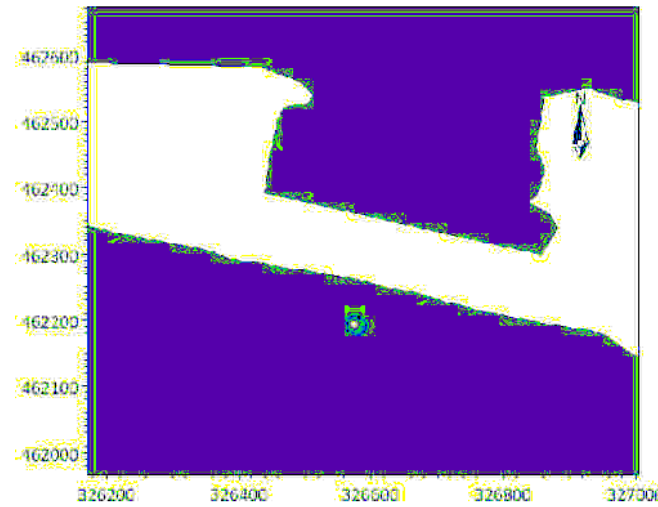


Figure C.34: NE\_N\_08\_Westward Flow

Excess Temperature [deg C]

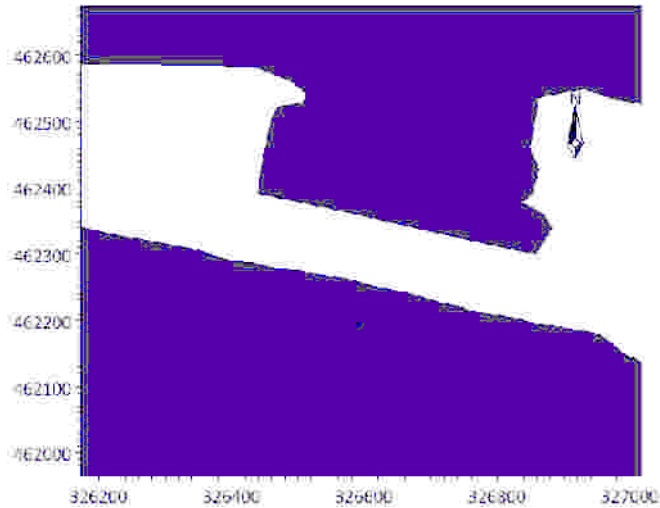
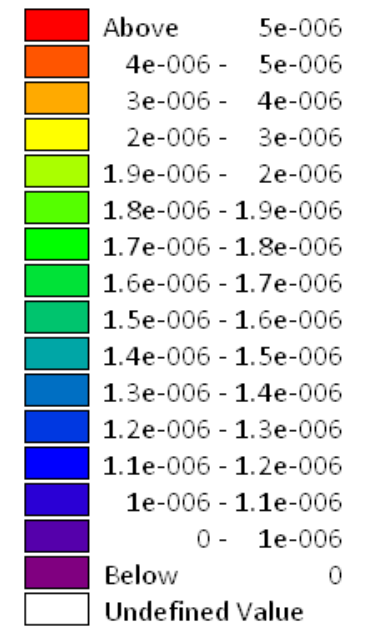


Figure C.35: NE\_N\_09\_Eastward Flow

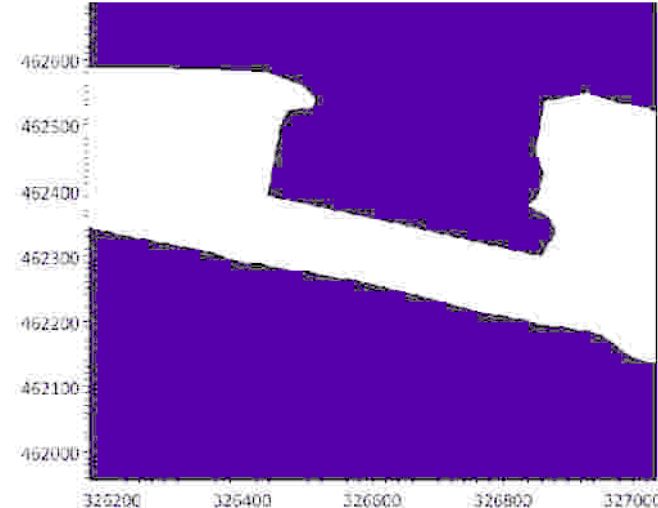


Figure C.36: NE\_N\_09\_Westward Flow

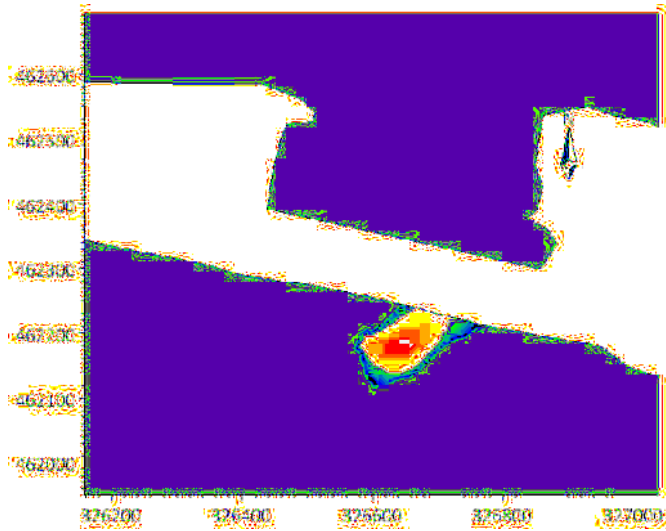


Figure C.37: SW\_S\_01\_Eastward Flow

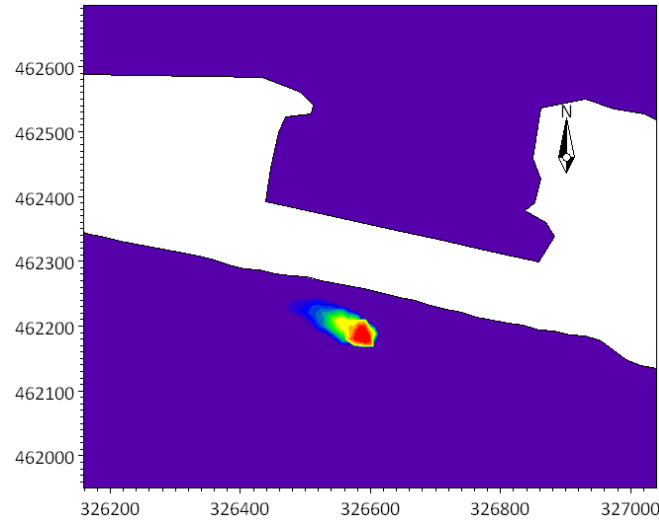


Figure C.38: SW\_S\_01\_Westward Flow

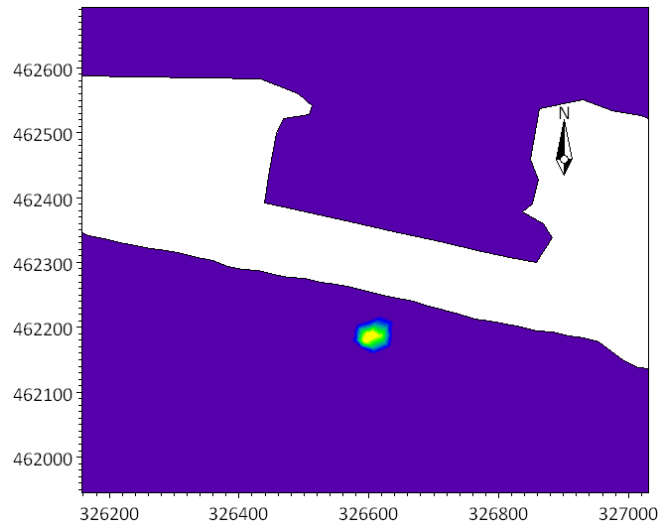
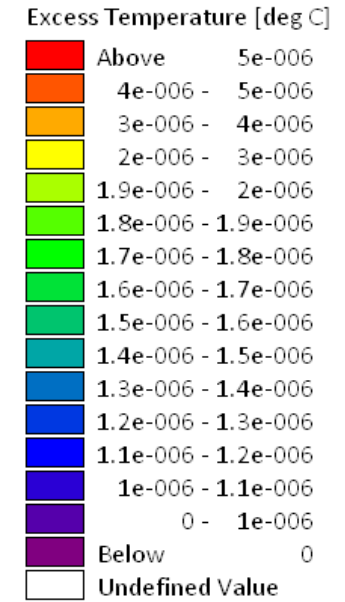


Figure C.39: SW\_S\_02\_Eastward Flow

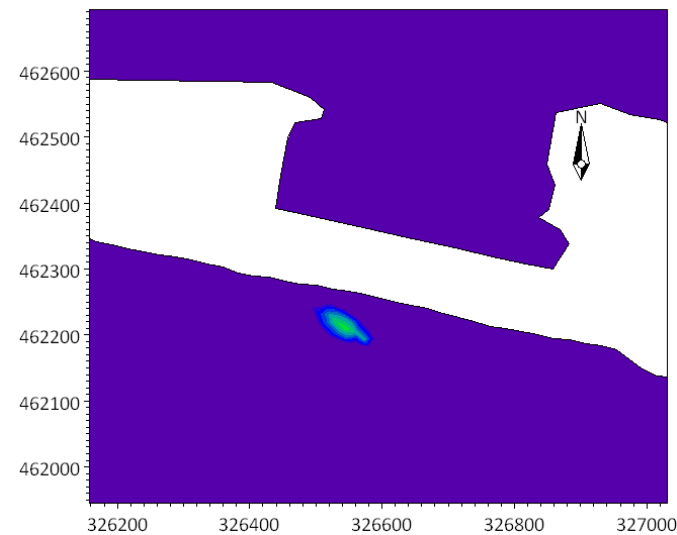


Figure C.40: SW\_S\_02\_Westward Flow

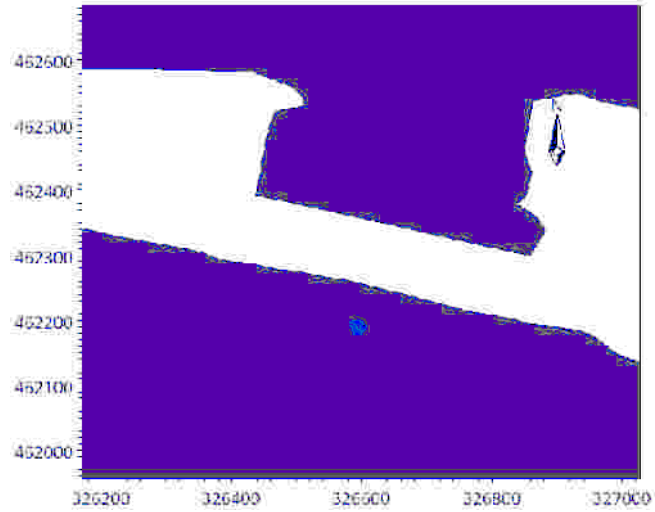


Figure C.41: SW\_S\_03\_Eastward Flow

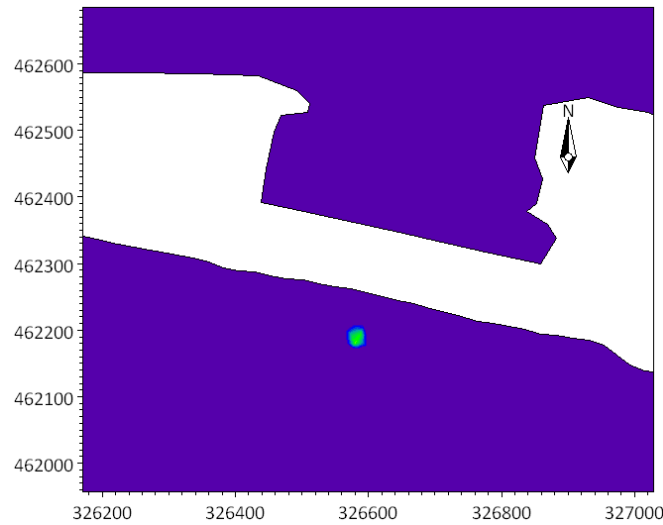


Figure C.42: SW\_S\_03\_Westward Flow

Excess Temperature [deg C]

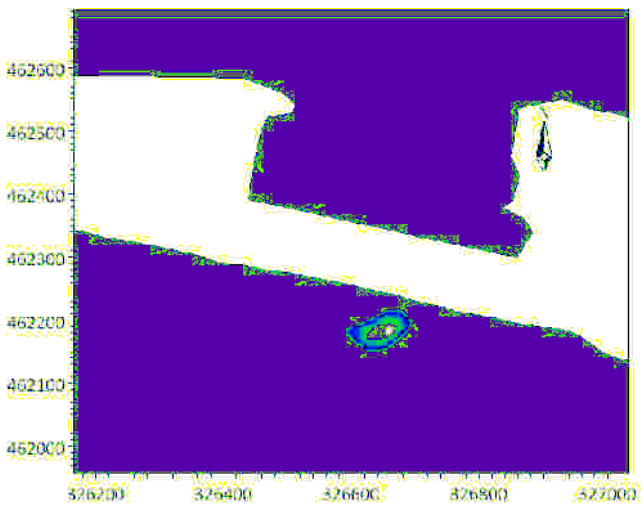
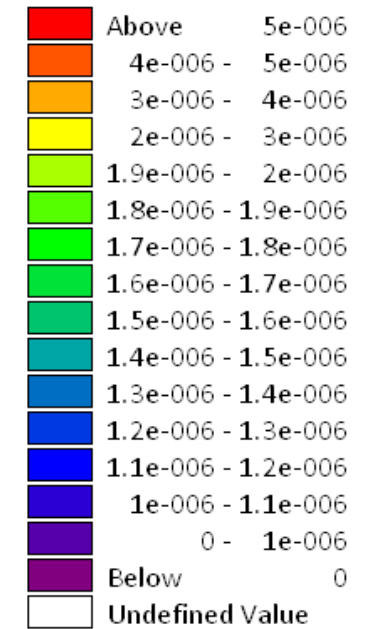


Figure C.43: SW\_S\_04\_Eastward Flow

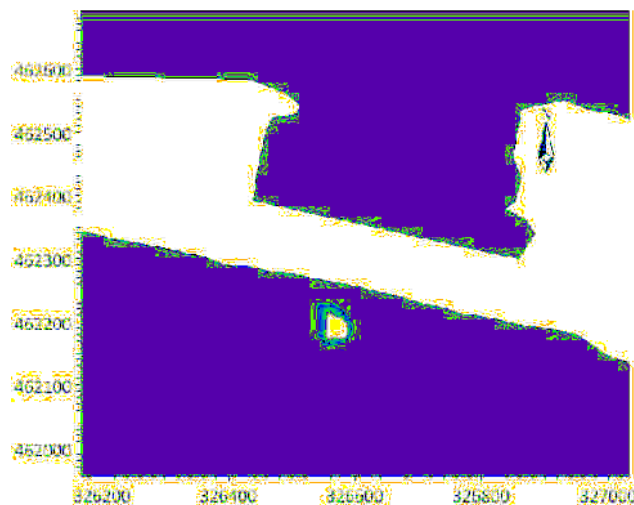


Figure C.44: SW\_S\_04\_Westward Flow

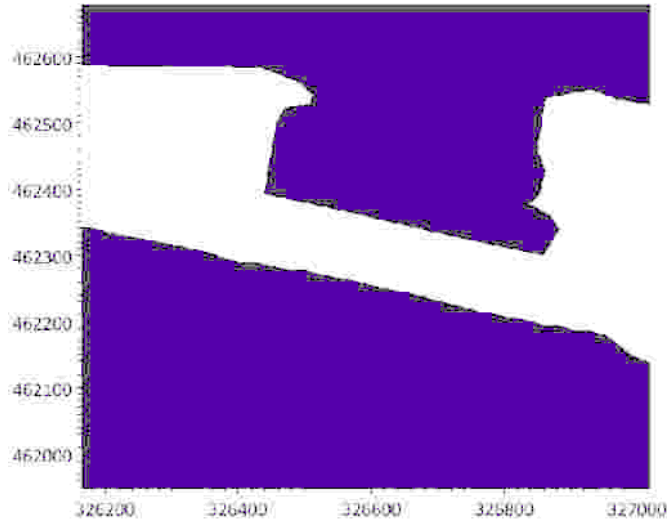


Figure C.45: SW\_S\_05\_Eastward Flow

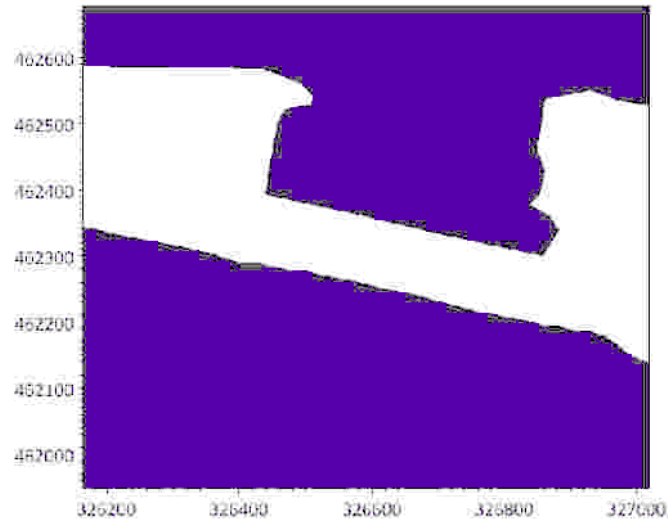


Figure C.46: SW\_S\_05\_Westward Flow

Excess Temperature [deg C]

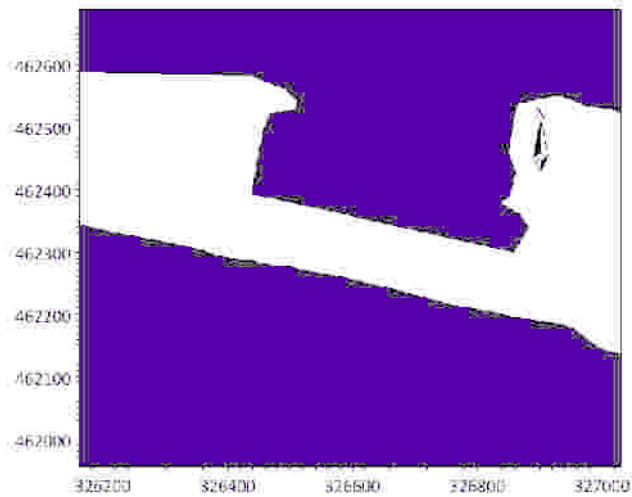
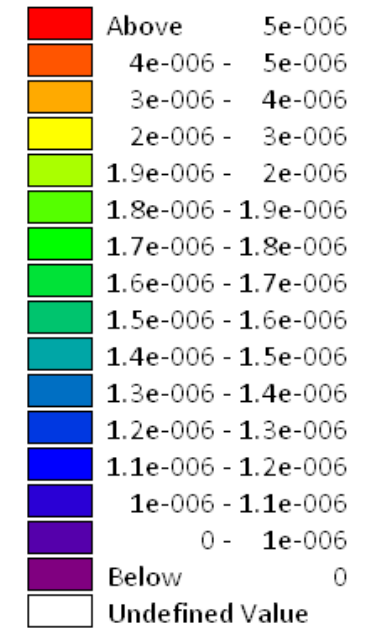


Figure C.47: SW\_S\_06\_Eastward Flow

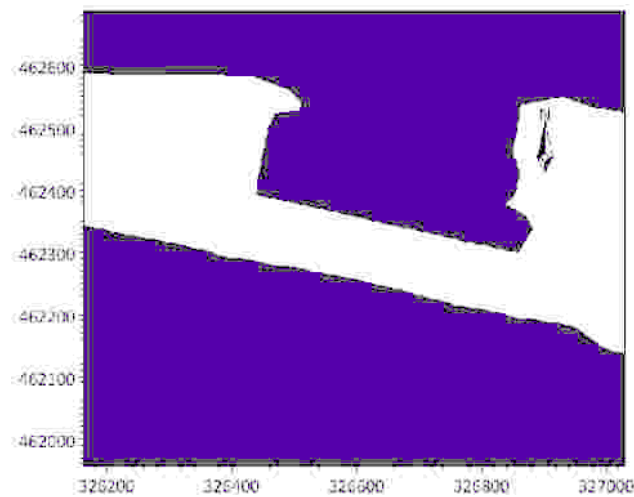


Figure C.48: SW\_S\_06\_Westward Flow

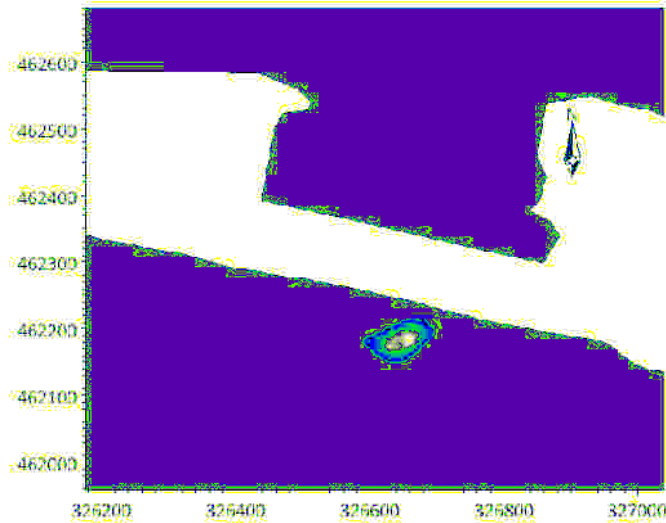


Figure C.49: SW\_S\_07\_Eastward Flow

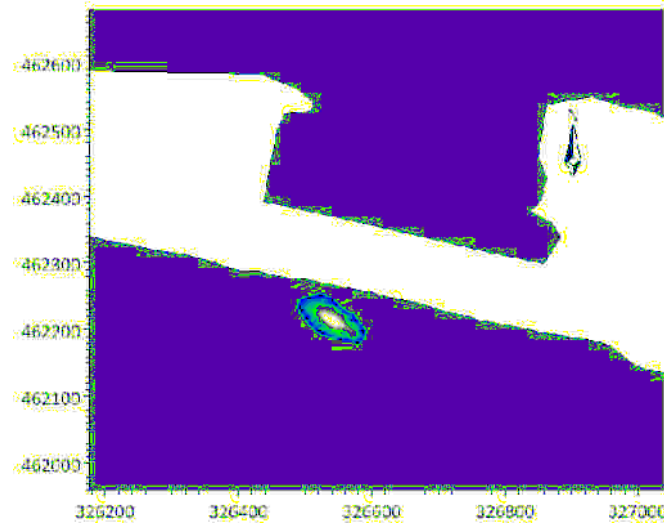


Figure C.50: SW\_S\_07\_Westward Flow

Excess Temperature [deg C]

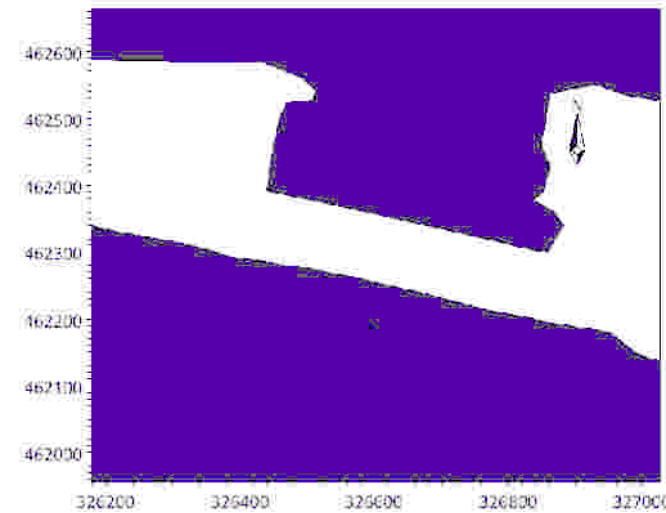
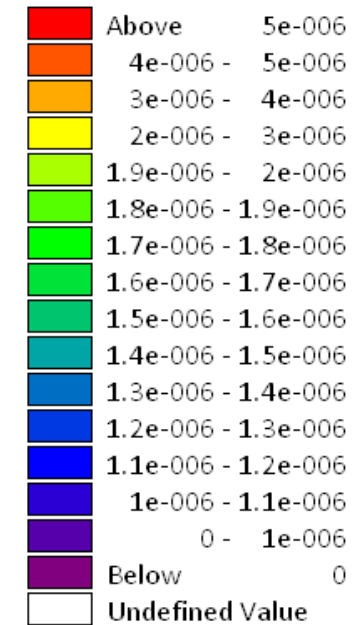


Figure C.51: SW\_S\_08\_Eastward Flow

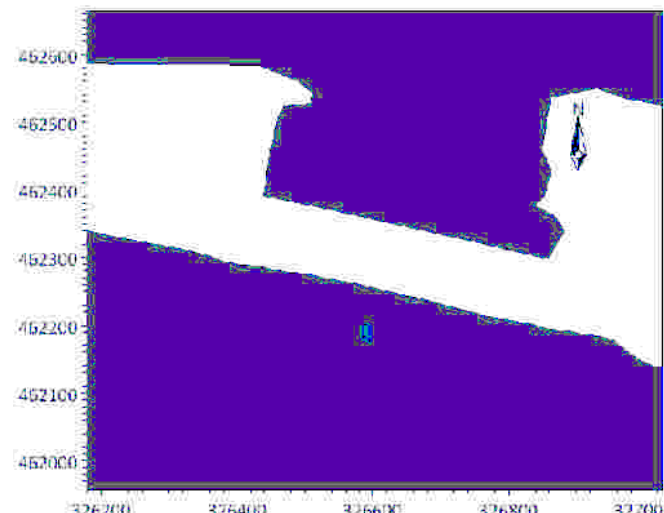


Figure C.52: SW\_S\_08\_Westward Flow

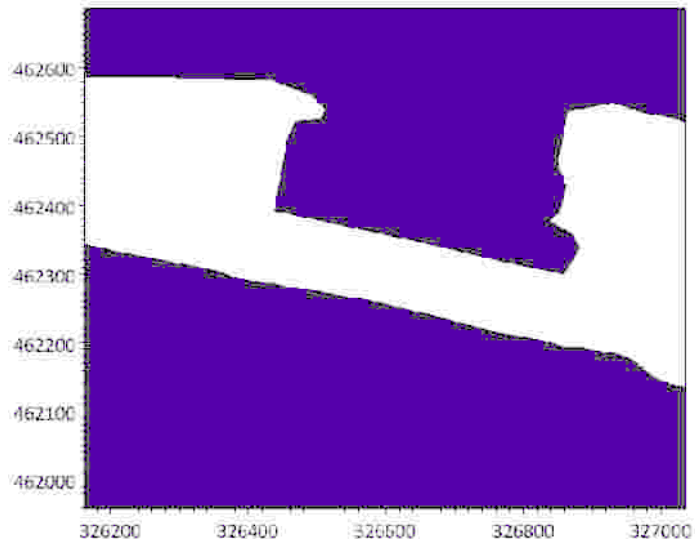


Figure C.53: SW\_S\_09\_Eastward Flow

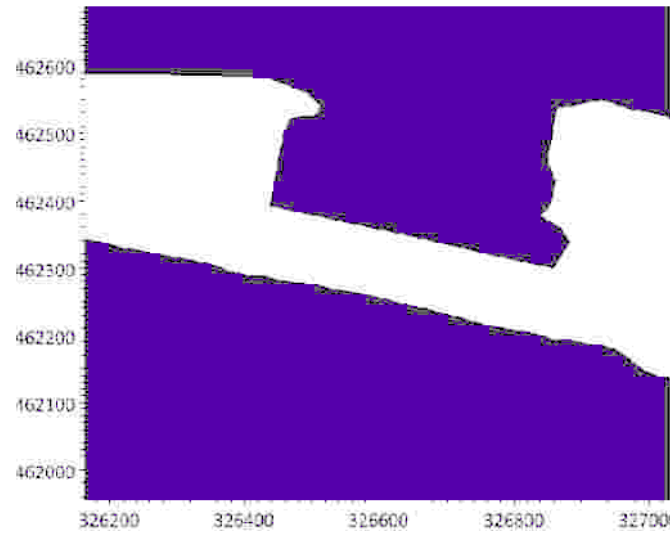


Figure C.54: SW\_S\_09\_Westward Flow

Excess Temperature [deg C]

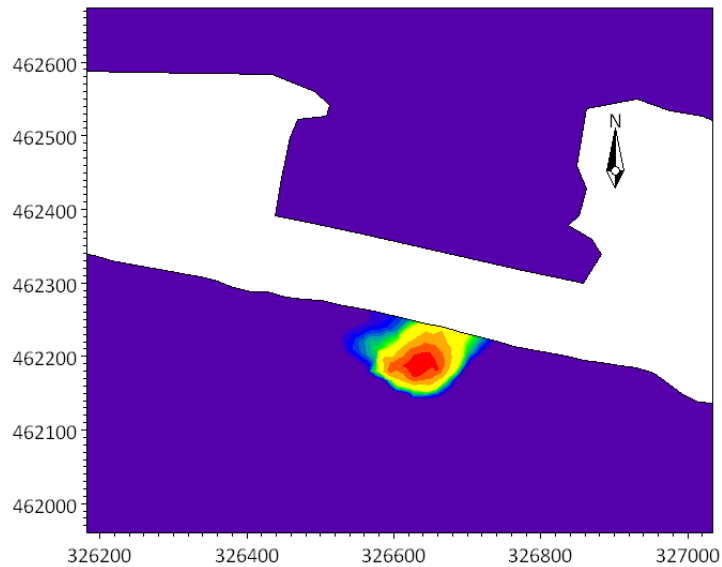
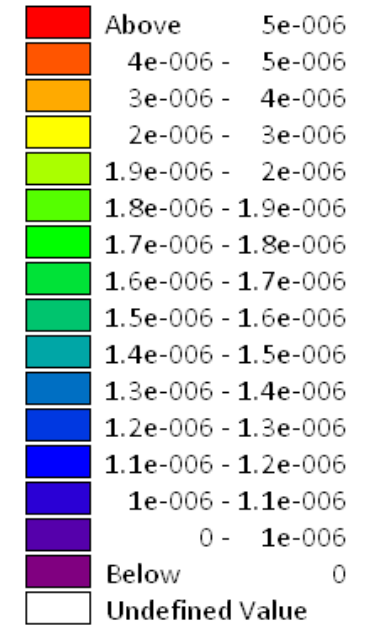


Figure C.55: SW\_N\_01\_Eastward Flow

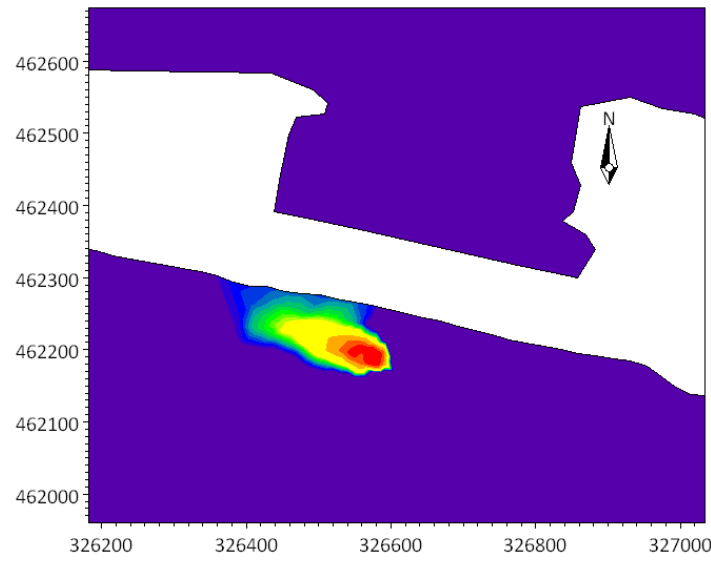


Figure C.56: SW\_N\_01\_Westward Flow

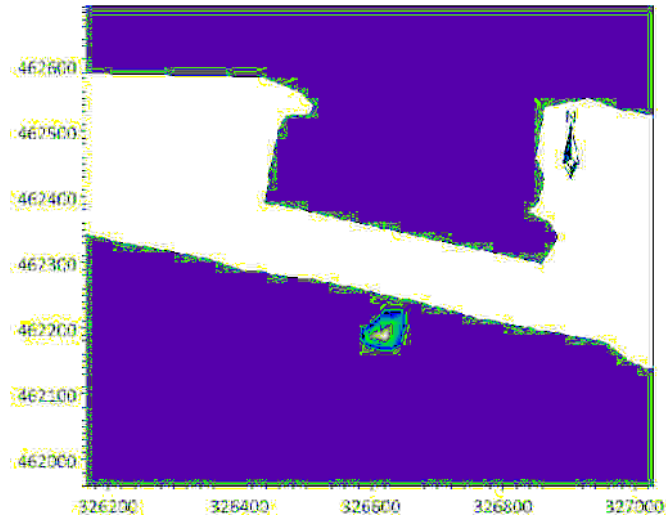


Figure C.57: SW\_N\_02\_Eastward Flow

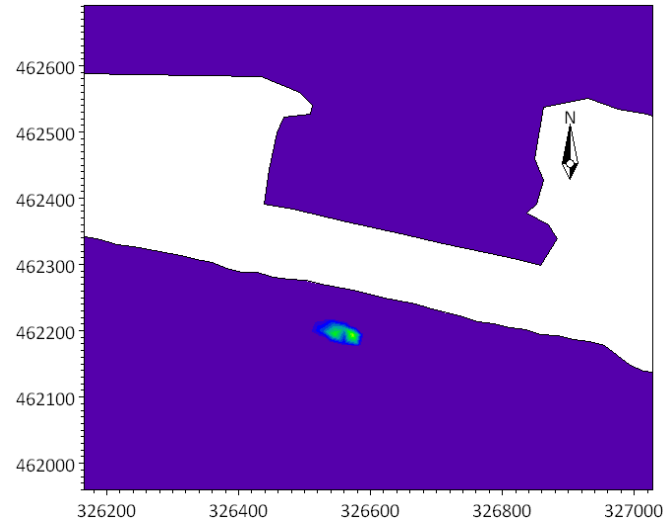


Figure C.58: SW\_N\_02\_Westward Flow

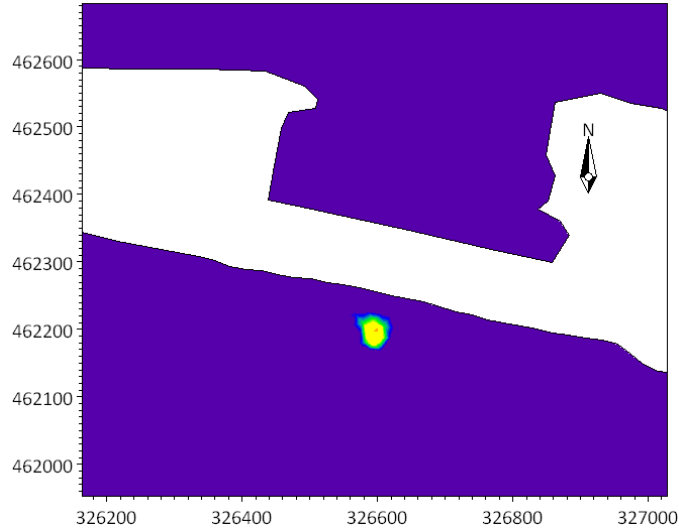
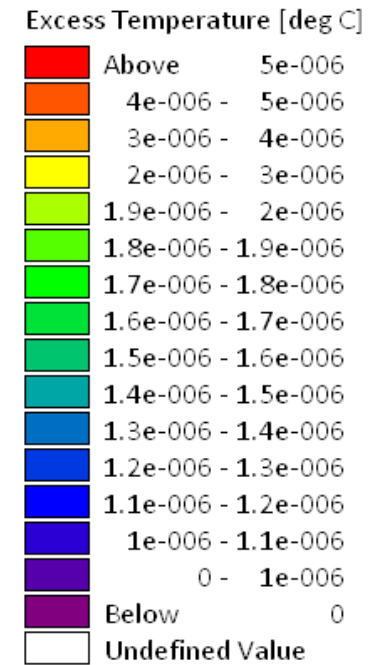


Figure C.59: SW\_N\_03\_Eastward Flow

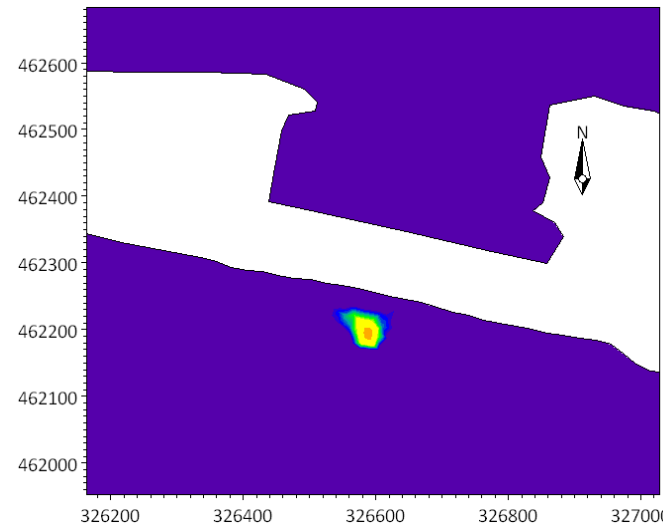


Figure C.60: SW\_N\_03\_Westward Flow



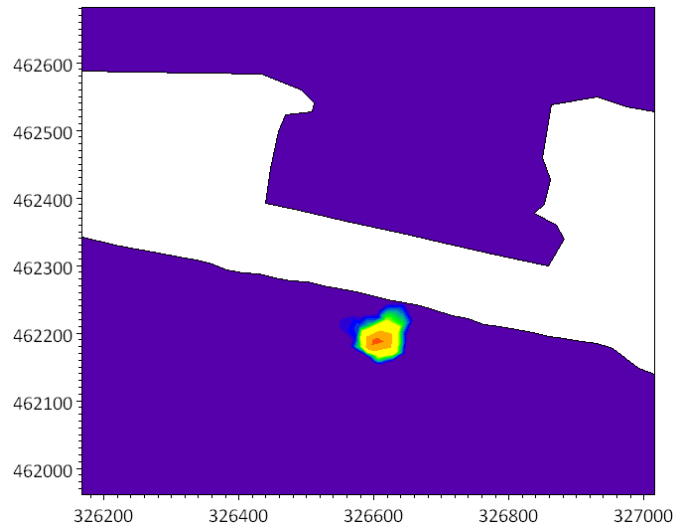


Figure C.61: SW\_N\_04\_Eastward Flow

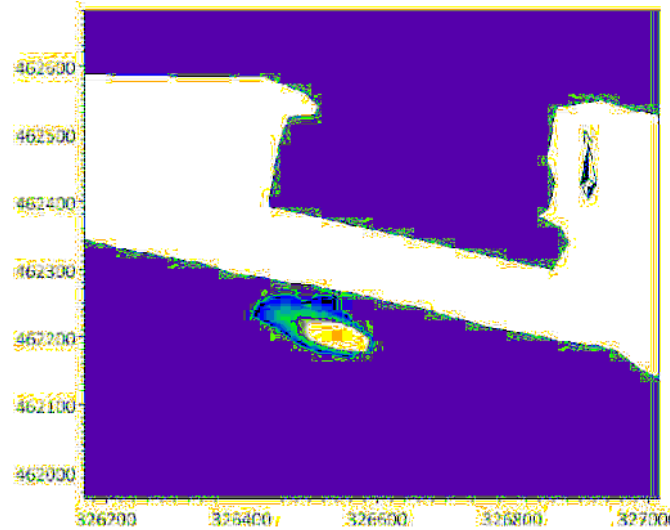


Figure C.62: SW\_N\_04\_Westward Flow

Excess Temperature [deg C]

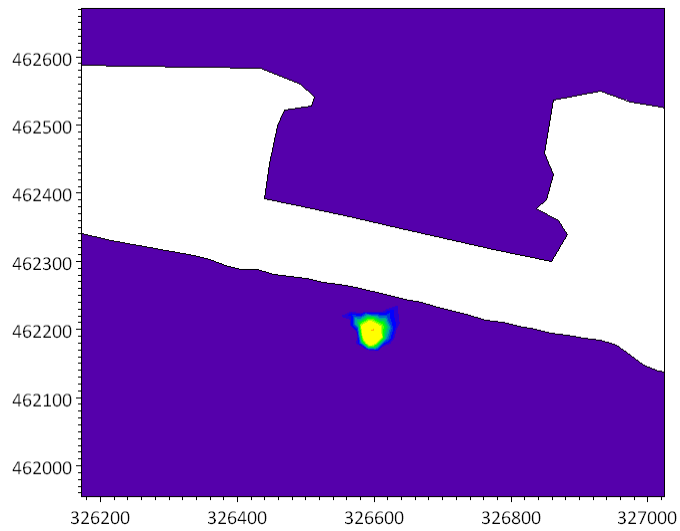
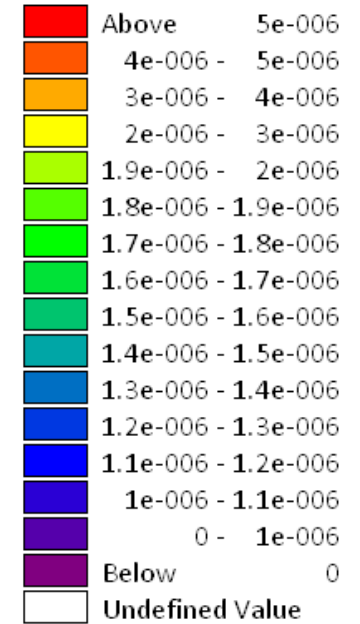


Figure C.63: SW\_N\_05\_Eastward Flow

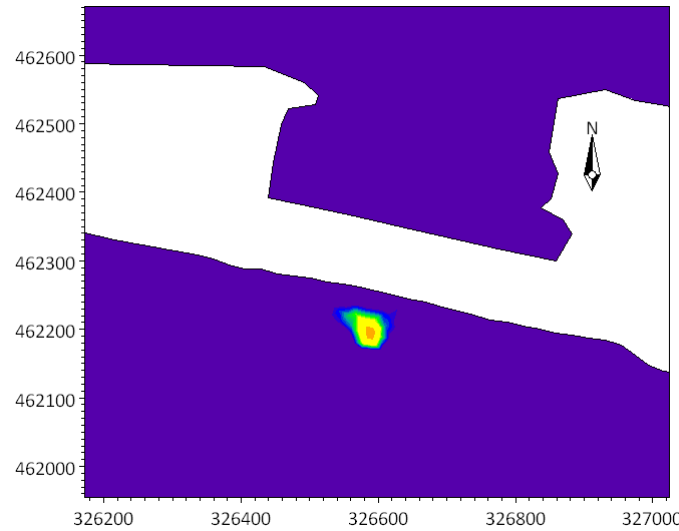


Figure C.64: SW\_N\_05\_Westward Flow

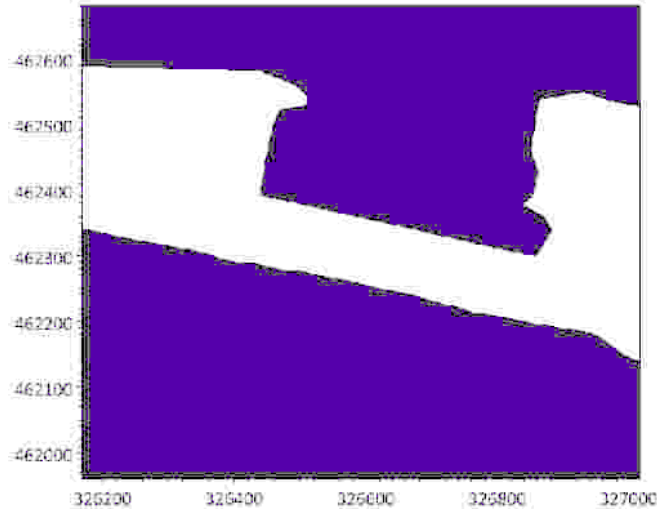


Figure C.65: SW\_N\_06\_Eastward Flow

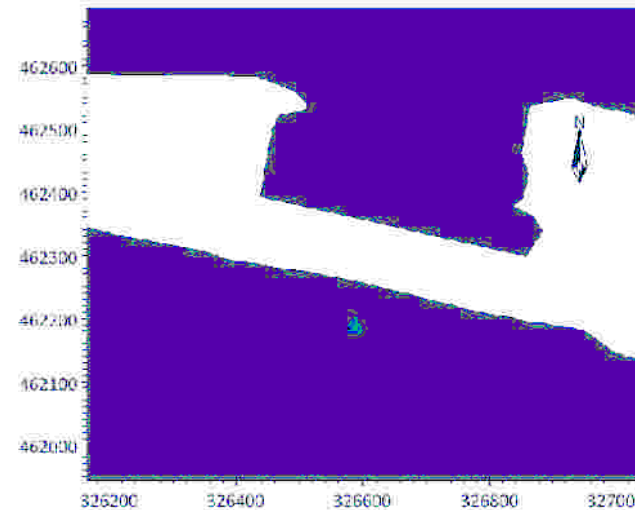


Figure C.66: SW\_N\_06\_Westward Flow

Excess Temperature [deg C]

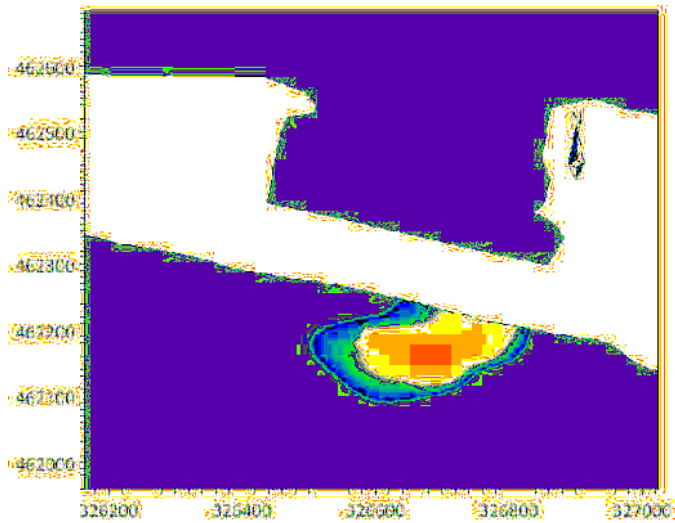
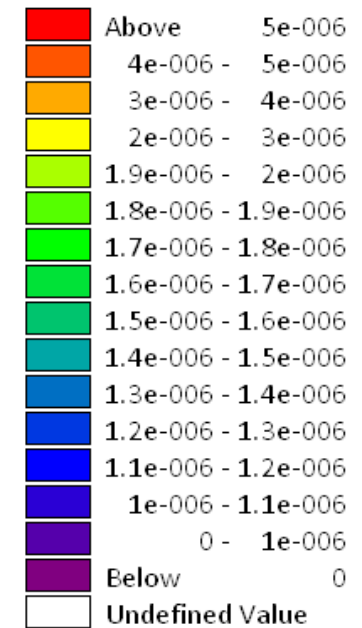


Figure C.67: SW\_N\_07\_Eastward Flow

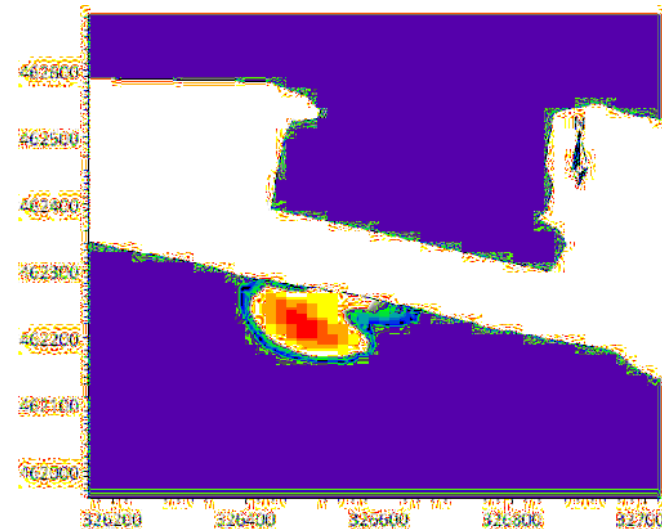


Figure C.68: SW\_N\_07\_Westward Flow

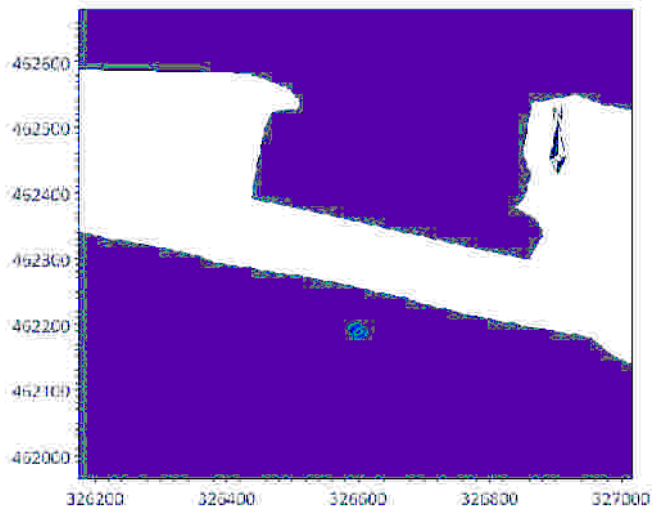


Figure C.69: SW\_N\_08\_Eastward Flow

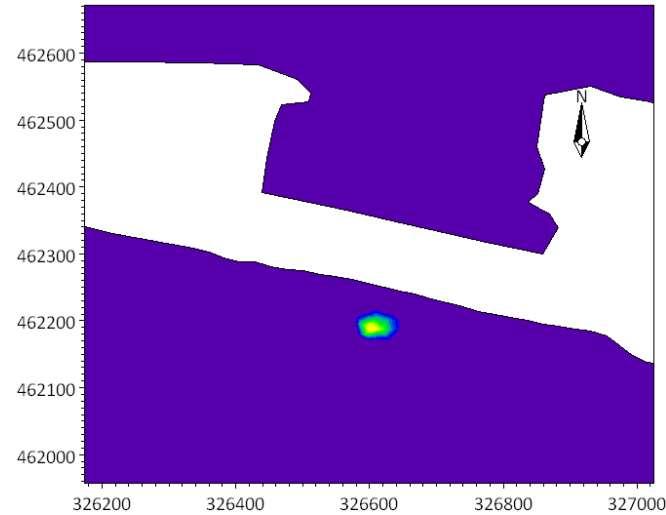


Figure C.70: SW\_N\_08\_Westward Flow

Excess Temperature [deg C]

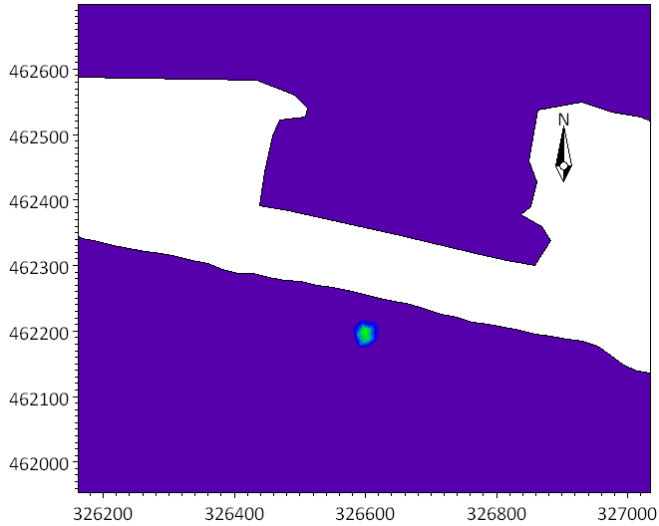
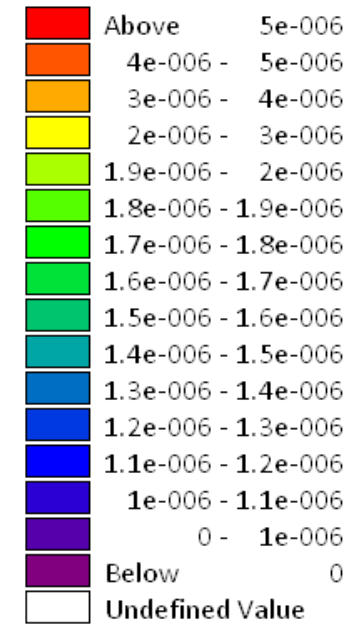


Figure C.71: SW\_N\_09\_Eastward Flow

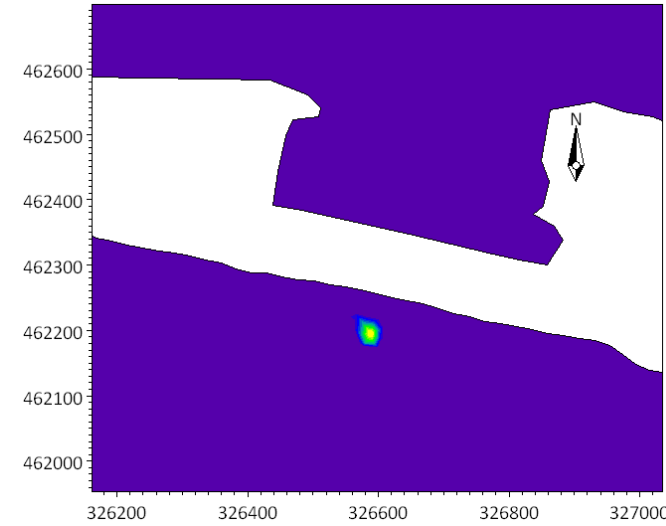


Figure C.72: SW\_N\_09\_Westward Flow

Environmental and Social Impact Assessment for the Regional Solid Waste Management Facility (RSWMF) Thilafushi

## **Noise Level Measurement**

**Prepared by:** Abdul Aleem (EIA P03/2019)

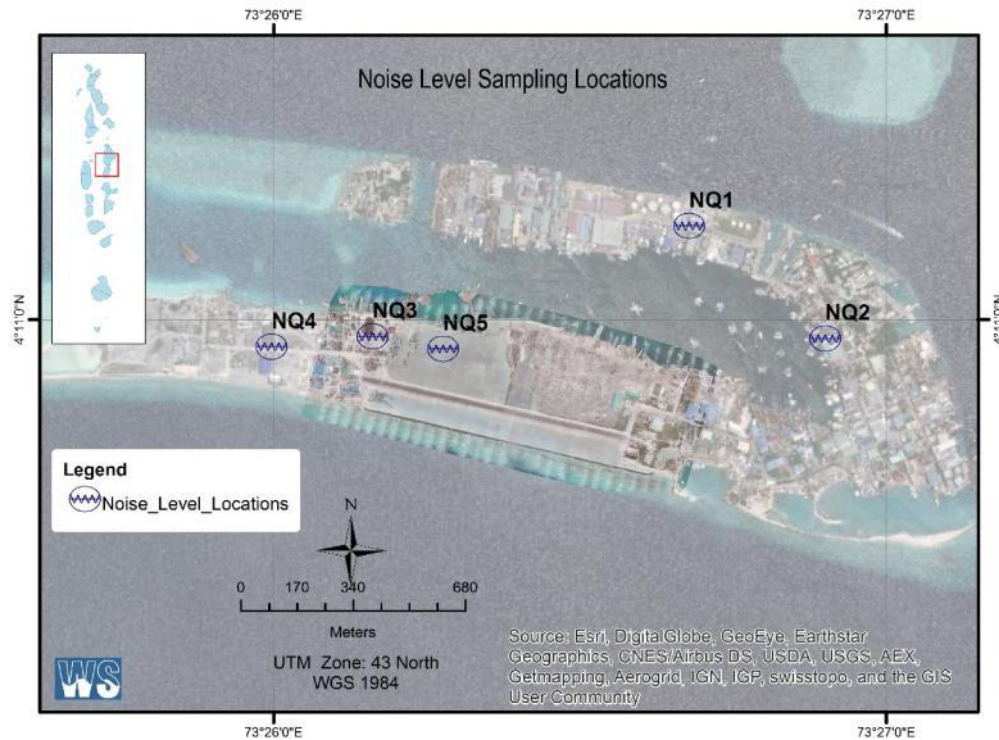


23<sup>rd</sup> September 2019

## Noise Level Measurement

Noise level was measured to establish baseline at five locations: NQ1, NQ2, NQ3, NQ4 and NQ5 by Water Solutions on 25th August 2019 using hand held sound level meter at Thilafushi. Ambient noise levels were measured during the day time from 10:00 am to 12:00 pm and during the night from 10:00 pm to 12:00 pm at 5 locations (see map). The day time was considered as 7:00 a.m. to 10:00 p.m, while the night time was considered as 10:00 p.m. to 7:00am.

Station Name	Station Coordinates	Monitoring rationale
NQ1 (Thilafushi)	4°10'26.4 N 73°28'59.9 E	The station was selected as it represents a major industrial location of the island and is also located close to the harbour. The location lies north of the proposed facility on the opposite side of the lagoon.
NQ2 (Thilafushi)	4°10'56.6 N 73°26'53.3 E	The station was selected as it represents a major industrial location of the island. The location lies east of the proposed facility on the opposite side of the lagoon. The location has various industrial activities in its proximity
NQ3 (Thilafushi)	4°10'58.3 N 73°26'09.6 E	This station was selected as it is located near the boundary of the proposed WTE facility.
NQ4 (Thilafushi)	4°10'57.3 N 73°25'59.4 E	This station was selected as it is located west of proposed WTE facility. The area has less development and less activity during the day time.
NQ5 (Thilafushi)	4°10'57.3 N 73°26'14.4 E	This station was selected as it is located at the proposed WTE facility.



**Figure: Locations where noise was monitored for the baseline assessment.**

---

**Table: Summary of Noise Quality Results for Thilafushi**

<b>S. No</b>	<b>Locations</b>	<b>Noise Level dB (A) Day Time</b>	<b>Noise Level dB (A) Night Time</b>
NQ1	Thilafushi	65.1	53.7
NQ2	Thilafushi	64.2	51.8
NQ3	Thilafushi	56.3	50.0
NQ4	Thilafushi	56.0	48.9
NQ5	Thilafushi	54.6	49.0

The ambient noise levels were moderate to high considering the international standards. The higher background noise can be attributed to the roar from the sea, windy conditions and closely packed industrial areas and movement of boats. Thilafushi was quieter during the night as there are no activity on the island.

Environmental and Social Impact Assessment for the Regional Solid Waste Management Facility (RSWMF) Thilafushi

## **Noise Level Measurement (Additional Measurements)**

**Prepared by:** Abdul Aleem (EIA P03/2019)

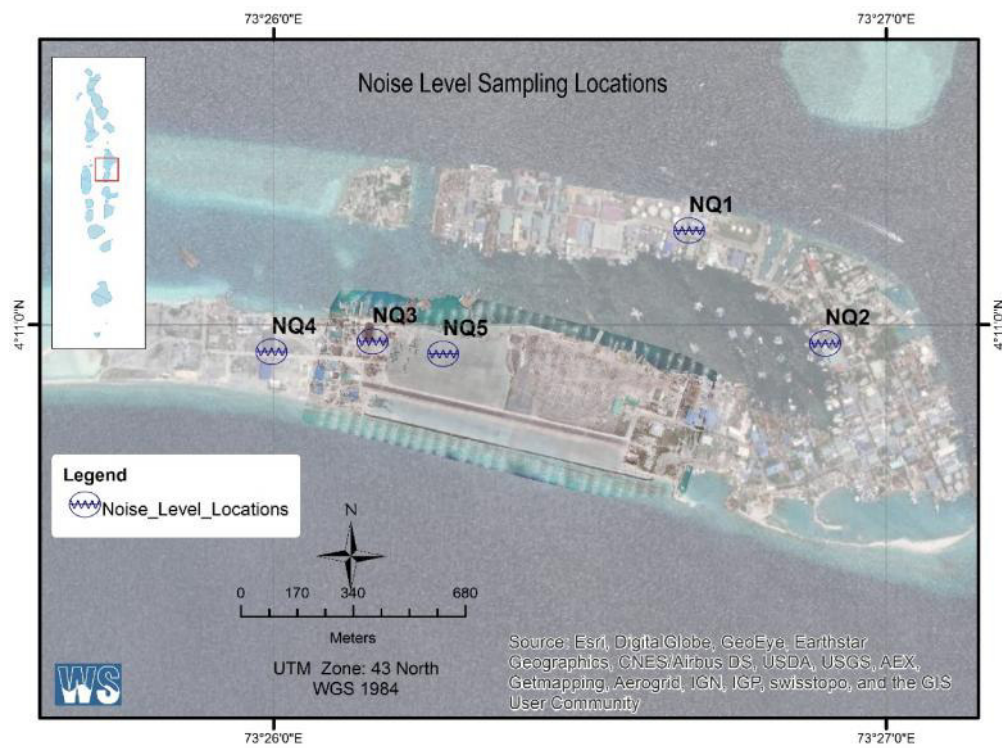


24<sup>th</sup> October 2019

## Noise Level Measurement

Additional Noise level was measured at two locations: NQ3 and NQ4 by Water Solutions on 6<sup>th</sup> and 7<sup>th</sup> October 2019 using hand held sound level meter at Thilafushi. Ambient noise levels were measured every hour for 24 hours at each locations.

Station Name	Station Coordinates	Monitoring rationale
NQ3 (Thilafushi)	4°10'58.3 N 73°26'09.6 E	This station was selected as it is located near the boundary of the proposed WTE facility.
NQ4 (Thilafushi)	4°10'57.3 N 73°25'59.4 E	This station was selected as it is located west of proposed WTE facility. The area has less development and less activity during the day time.



**Figure: Locations where noise was monitored for the baseline assessment.**



---

**Table: Noise Measurement Results for Thilafushi**

<b>Date</b>	<b>Time</b>	<b>Noise Level dB (A)</b>	
		<b>NQ3</b>	<b>NQ4</b>
6/10/2019	7:00	50.1	52.4
6/10/2019	8:00	54.4	54.3
6/10/2019	9:00	55.7	56.2
6/10/2019	10:00	56.5	56.8
6/10/2019	11:00	57.1	55.4
6/10/2019	12:00	56.8	57.4
6/10/2019	13:00	57.4	56.4
6/10/2019	14:00	57.3	55.9
6/10/2019	15:00	56.7	55.4
6/10/2019	16:00	56.8	56.1
6/10/2019	17:00	51.3	54.3
6/10/2019	18:00	49.4	49.4
6/10/2019	19:00	50.1	48.9
6/10/2019	20:00	49.6	48.6
6/10/2019	21:00	49.3	48.3
6/10/2019	22:00	50.1	48.5
6/10/2019	23:00	50.3	48.3
7/10/2019	0:00	50.1	48.1
7/10/2019	1:00	50.1	48.1
7/10/2019	2:00	50.3	48.3
7/10/2019	3:00	50.8	47.8
7/10/2019	4:00	50.2	48
7/10/2019	5:00	49.5	49.1
7/10/2019	6:00	49.8	49.3

The ambient noise levels were low considering the international standards. The background noise can be attributed to the roar from the sea, windy conditions areas and movement of boats. Thilafushi was quitter during the night as there are no activity on the island.



# TEST REPORT



**Report No:** (7419)080-0561A(S)

May 16, 2019

Page 1 of 4

**Attn: Mr. Nashfa Nashidh**

**Customer:** Water Solutions (Pvt) Ltd

**Address :** MA. Faseri, 1<sup>st</sup> Floor, Ameenee Magu, Male, Maldives

**Date of Sample Received:** Apr 03, 2019

**Date of Testing Started:** Apr 03, 2019

**Date of Report Modified:** May 16, 2019

**Date of Testing Completed:** May 16, 2019

**Sample Description:**

**Sample Received as:**

Approximately 500ml x 3 Nos. of Water sample contained in two sealed plastic bottles & one glass bottle respectively

**Sample Identified by the Client as:**

Ground Water

Thilafushi GW 1

**Sample Drawn By BVCPS** NO

## Photo of the Samples Submitted



**Bureau Veritas Consumer Products Services Lanka (Pvt) Ltd.**

No. 570, Galle Road, Katubedda, Moratuwa, Sri Lanka  
Tel: (9411) 2350111-115 (dedicated lines), Fax: (9411) 112622198 & 199  
Email: [bvcps.lanka@lk.bureauveritas.com](mailto:bvcps.lanka@lk.bureauveritas.com)

This report is governed by, and incorporates by reference, the Conditions of Testing as posted at the date of issuance of this report at <http://www.cps.bureauveritas.com> and is intended for your exclusive use. Any copying or replication of this report to or for any other person or entity, or use of our name or trademark, is permitted only with our prior written permission. This report sets forth our findings solely with respect to the test samples identified herein. The results set forth in this report are not indicative or representative of the quality or characteristics of the lot from which a test sample was taken or any similar or identical product unless specifically and expressly noted. Our report includes all of the tests requested by you and the results thereof based upon the information that you provided to us. You have 60 days from date of issuance of this report to notify us of any material error or omission caused by our negligence; provided, however, that such notice shall be in writing and shall specifically address the issue you wish to raise. A failure to raise such issue within the prescribed time shall constitute your unqualified acceptance of the completeness of this report, the tests conducted and the correctness of the report contents.

# TEST REPORT



Report No:

(7419)080-0561A(S)

May 16, 2019

Page 2 of 4

## TEST RESULTS

No.	Parameters	Results	LOQ	Unit	Test Method
1	Turbidity*	1.3	-	NTU	APHA 23rd ed: 2017: 2130 B
2	pH at 25°C*	7.3	-	-	APHA 23rd ed: 2017 :4500H <sup>+</sup>
3	Iron (as Fe)*	0.4	-	mg/l	APHA 23rd ed: 2017: 3125 B
4	Manganese (as Mn)	0.02	-	mg/l	APHA 23rd ed: 2017: 3125 B
5	Arsenic ( as As)	ND	0.001	mg/l	APHA 23rd ed: 2017: 3125 B
6	Total Dissolved Solids*	794	-	mg/l	APHA 23rd ed: 2017: 2540 C
7	Electrical Conductivity at 25°C*	1.39	-	mS/cm	APHA 23rd ed: 2017; 2510 B
8	Cadmium (as Cd)*	ND	0.0001	mg/l	APHA 23rd ed: 2017: 3125 B
9	Lead (as Pb)*	ND	0.001	mg/l	
10	Mercury (as Hg)	ND	0.00005	mg/l	
11	<b>Polynuclear Aromatic Hydrocarbons*</b>				
a	Naphthalene	ND	1.0	µg/l	CPSD –AN-00576
b	Acenaphthylene	ND	1.0	µg/l	CPSD –AN-00576
c	Acenaphthene	ND	1.0	µg/l	CPSD –AN-00576
d	Fluorene	ND	1.0	µg/l	CPSD –AN-00576
e	Phenanthrene	ND	1.0	µg/l	CPSD –AN-00576
f	Anthracene	ND	1.0	µg/l	CPSD –AN-00576
g	Fluoranthene	ND	1.0	µg/l	CPSD –AN-00576
h	Pyrene	ND	1.0	µg/l	CPSD –AN-00576
i	Benzo[a]anthracene	ND	1.0	µg/l	CPSD –AN-00576
j	Chrysene	ND	1.0	µg/l	CPSD –AN-00576
k	Benzo[a]pyrene	ND	1.0	µg/l	CPSD –AN-00576
l	Benzo[e]pyrene	ND	1.0	µg/l	CPSD –AN-00576
m	Indeno[1,2,3-cd]pyrene	ND	1.0	µg/l	CPSD –AN-00576
n	Dibenzo[a,h]anthracene	ND	1.0	µg/l	CPSD –AN-00576
o	Benzo[g,h,i]perylene	ND	1.0	µg/l	CPSD –AN-00576
p	Benzo[b]fluoranthene	ND	1.0	µg/l	CPSD –AN-00576
q	Benzo[j]fluoranthene	ND	1.0	µg/l	CPSD –AN-00576
r	Benzo[k]fluoranthene	ND	1.0	µg/l	CPSD –AN-00576

# TEST REPORT



Report No: (7419)080-0561A(S)

May 16, 2019

Page 3 of 4

(\*)Indicates- ISO 17025: 2005 accredited test.

**Remark:**

The test report (7419)080-0561A has been replaced with the test report (7419)080-0561A(S) in order to add test results of Heavy metals.

**NOTE:**

APHA: American Public Health Association,  
SLS: Sri Lanka Standard, ND: Not Detected,  
LOQ: Limit of Quantification, mg/l: milligrams per liter,  
°C :Celsius, NTU: Nephelometric Turbidity Units,  
mS/cm : milliSiemens per centimeter.

**Contact Information for this report (Technical and General Inquiries and Feedback)**

<b>GENERAL INQUIRIES:</b>		
IROSHA UDUGAMPALA	TEL: +94 768 229 528	E-MAIL: Irosha.Udugampala@lk.bureauveritas.com
<b>TECHNICAL INQUIRIES:</b>		
ROHITHA GUNARATHNA	TEL: +94 774 151 768	E-MAIL: rohitha.gunarathna@lk.bureauveritas.com
<b>FEED BACK:</b>		
KUMUDINI RATHNAYAKE	TEL: +94 768 229 455	E-MAIL: kumudinie.rathnayake@lk.bureauveritas.com

REVIEWED BY: SHYAMIKA WICKRAMASINGHE

BUREAU VERITAS CONSUMER PRODUCTS SERVICES LANKA (PVT) LTD.

AUTHORIZED SIGNATORY

ROHITHA GUNARATHNA

MANAGER-  
ANALYTICAL LABORATORY

# TEST REPORT



Report No:

(7419)080-0561C(S)

May 16, 2019

Page 4 of 4

## CPS CONDITIONS OF SERVICE

The party that submits a completed service request form to Company or signs a quotation issued by the Company for its performance of services ("Services") is the "Client" under these Conditions of Service. The entity within the Bureau Veritas Consumer Products Services division accepting the service request form and issuing the Report documenting the results of those Services is the "Company" under these Conditions of Service. Company and Client are, together, the "Parties" and each is a "Party". A request for Services constitutes a legally binding agreement on both Parties when such a request is accepted by the Company ("Agreement") under the following terms and conditions (collectively, "Conditions").

**1. Services.** (a) The completion of the Services shall be evidenced by the Company's issuing to Client a written report setting forth the results of the Services based upon the properly accepted request, applicable protocols, written information, and where applicable, the product sample provided by Client to Company ("Report"). Company may delegate/assign the performance of all or a portion of the Services to an affiliate of Company or to an agent or subcontractor. Client shall provide to Company on a timely basis, all documents and information necessary to enable Company to properly perform the Services. Company may, in its sole discretion, dispose of product samples furnished to Company for the Services that were not destroyed in the course of performance of the Services. (b) Client represents and warrants to Company that (i) each product sample is not submitted in violation of a third party's intellectual property rights; (ii) Client will not use and rely upon Company's Report for any product whose properties differ from the sample(s) upon which the Report is based; and (iii) any goods subject to inspection will be completely prepared for the type of inspection booked for the specified date, and (c) Client accepts sole responsibility and liability for the accuracy of documents submitted to government or other regulatory bodies, including certificates of compliance required under the US Consumer Product Safety Improvement Act and EU requirements under REACH regulations. Client's responsibility and liability for accuracy shall apply even where Company has provided assistance to Client in preparation of such documentation.

**2. Report.** (a) The Report shall (i) constitute the sole deliverable for the Services, (ii) relate solely to the facts and circumstances as observed and recorded by Company at the time of performance of the Services within the limits of written information and instructions received from Client. Company shall have no obligation to update the Report after its issuance. Where the Services include testing or inspection: (i) the Report will set forth the findings of Company solely with respect to the product samples identified therein and (ii) the results set forth in the Report are not to be construed as indicative or representative of the quality or characteristics of the lot from which a product sample was taken for Company's performance of Services. (b) The Report is issued solely by Company, is intended for the exclusive use of Client and its affiliates and, except as required by a regulatory body, shall not be published, used for advertising purposes, copied or replicated for distribution or publicly disclosed without Company's prior written consent. Company is not responsible for any third party's interpretation of the Report. (c) Client shall not request a Report for purposes of litigation, nor shall it list Company, its affiliates or employees as an expert in any proceeding without Company's prior written consent. If Client anticipates producing or otherwise using the Report in any legal proceedings, it shall so notify Company prior to submitting the Report in such proceeding.

**3. Representations and Warranties.** (a) Company undertakes due care and ordinary skill in the performance of its Services. (b) Client agrees that Company is neither an insurer nor a guarantor and does not take the place of Client or the third parties that it retains, including designers, manufacturers, agents, buyers, distributors, and transportation or shipping companies; Company disclaims all liability in such capacities. Client understands that, if it seeks to protect itself from claims of loss, damage or injury, it should obtain appropriate insurance. (c) Company does not warrant or guarantee Client's products, and Company's Report does not represent a warranty of merchantability, a warranty of fitness for a particular purpose, or any other warranty or guarantee.

**4. Payment.** Payment in full shall be due 30 days after the date of invoice, failing which Company may revoke any credit extended to Client. Client shall reimburse Company for (i) interest on overdue amounts from the due date until paid at an interest rate of 1.5% per month and (ii) any other costs Company incurs in collecting past due amounts, including court, attorneys and collection agencies' fees.

**5. Intellectual Property.** The names, service marks, trademarks and copyrights of Company and its affiliates (collectively, the "Marks") are and remain the sole property of Company and shall not be used by Client. Client shall not contest the validity of the Marks or take any action that might impair the value or goodwill associated with the Marks or the image or reputation of Company or its affiliates. Client understands that any information or samples submitted to Company is a license for Company to use the same in the performance of Services.

**6. Relationship.** (a) Nothing herein creates a partnership, agency or joint venture between the Parties. (b) The failure to require strict observance or performance of any provision of these Conditions shall not be construed to be a waiver of a Party's right to later require strict observance and performance of the same. If any provision of these Conditions is held to be invalid or unenforceable, such invalidity shall not invalidate the remainder of the Conditions. (c) For a period of two years after the commencement of this Agreement, Client shall not directly or indirectly try to solicit for employment any of Company's employees.

**7. INDEMNITY.** CLIENT SHALL HOLD HARMLESS AND INDEMNIFY COMPANY, ITS AFFILIATES AND THEIR RESPECTIVE DIRECTORS, OFFICERS, EMPLOYEES, AGENTS AND SUBCONTRACTORS AGAINST ALL THIRD-PARTY CLAIMS FOR LOSS, DAMAGE, INJURY, DEATH, OR EXPENSE OF WHATEVER NATURE, INCLUDING BUT NOT LIMITED TO CLAIMS ARISING FROM OR RELATING TO (I) THE PERFORMANCE OF ANY SERVICES BY COMPANY, (II) THE SALE, RESALE, MANUFACTURE, DISTRIBUTION OR USE OF ANY OF CLIENT'S GOODS OR (III) BREACH OF CLIENT'S OBLIGATIONS OR WARRANTIES HEREIN.

**8. LIMITATIONS OF LIABILITY.** (A) COMPANY SHALL NOT BE LIABLE FOR ANY INDIRECT, CONSEQUENTIAL OR SPECIAL LOSS IN CONNECTION WITH THE REPORT, THE PRODUCT FOR WHICH SERVICES WERE PERFORMED, OR THE SERVICES PROVIDED BY COMPANY HEREUNDER. COMPANY SHALL NOT BE LIABLE FOR ANY LOSS OR DAMAGE WHATSOEVER RESULTING FROM ANY DELAY IN THE PERFORMANCE OF ITS OBLIGATIONS HEREUNDER OR FROM THE FAILURE OF COMPANY TO PROVIDE ITS SERVICES WITHIN ANY TIME PERIOD FOR COMPLETION ESTIMATED BY COMPANY, REGARDLESS OF THE CAUSE OF THE DELAY OR FAILURE. (B) THE ENTIRE FINANCIAL AND LEGAL LIABILITY OF COMPANY IN RESPECT OF ANY CLAIM FOR LOSS, INDEMNITY, CONTRIBUTION OR DAMAGE OF WHATEVER NATURE OR HOWSOEVER ARISING, SHALL NOT EXCEED AN AMOUNT EQUAL TO FIVE (5) TIMES THE AMOUNT OF FEES PAID TO COMPANY FOR THE SPECIFIC SERVICES WHICH GAVE RISE TO SUCH CLAIM.

**9. Force Majeure.** If any event of force majeure or any event outside the control of Company occurs, Company may immediately cancel or suspend its performance hereunder without incurring any liability whatsoever to Client.

**10. Governing Law.** These Conditions shall be governed by the laws of the country as follows: for Services performed in (i) the Americas: the laws of New York, (ii) Asia Pacific, South Asia, Middle East and Africa: the laws of Hong Kong (except for China where PRC laws govern), and (iii) Europe: the laws of England.

**11. Dispute Resolution.** (a) If Client desires to assert a claim relating to the Services, it must submit the same to Company in writing setting forth with particularity the basis for such claim within 90 days from discovery of the claim and not more than six months after the date of issuance of the Report. Client waives any and all claims without limitation that it does not submit within such time periods. (b) If a dispute arises under this Agreement, the Parties shall first attempt good faith negotiations, failing which, the Parties (i) agree that the courts of the country of governing law shall have exclusive jurisdiction to settle any such dispute related to this Agreement and (ii) irrevocably waive their right to trial by jury in any such action or proceeding.

**12.** These Conditions, the applicable order form and/or quotation and the Report represent the entire understanding of the Parties on the subject matter hereof, and no modification is binding unless in writing. Any of Client's terms and conditions attached to, enclosed with or referred to in any order form, purchase order or other document shall not apply.

Gen v.1 copyright 2015 Bureau Veritas

**END OF THE REPORT.**



# TEST REPORT



Report No:

(7419)080-0561D(S)

May 16, 2019

Page 1 of 4

Attn: Mr. Nashfa Nashidh

Customer:

Water Solutions (Pvt) Ltd

Address :

MA. Faseri, 1<sup>st</sup> Floor, Ameenee Magu, Male, Maldives

Date of Sample Received:

Apr 03, 2019

Date of Testing Started:

Apr 03, 2019

Date of Report Modified:

May 16, 2019

Date of Testing Completed:

May 16, 2019

Sample Description:

Sample Received as:

Approximately 500ml x 3 Nos. of Water sample contained in two sealed plastic bottles & one glass bottle respectively

Sample Identified by the Client as:

Ground Water

Thilafushi GW 4

Sample Drawn By BVCPS

NO

## Photo of the Samples Submitted



**Bureau Veritas Consumer  
Products Services Lanka (Pvt)  
Ltd.**

No. 570, Galle Road, Katubedda, Moratuwa, Sri Lanka  
Tel: (9411) 2350111-115 (dedicated lines), Fax: (9411)  
112622198 & 199  
Email: [bvcps.lanka@lk.bureauveritas.com](mailto:bvcps.lanka@lk.bureauveritas.com)

This report is governed by, and incorporates by reference, the Conditions of Testing as posted at the date of issuance of this report at <http://www.cps.bureauveritas.com> and is intended for your exclusive use. Any copying or replication of this report to or for any other person or entity, or use of our name or trademark, is permitted only with our prior written permission. This report sets forth our findings solely with respect to the test samples identified herein. The results set forth in this report are not indicative or representative of the quality or characteristics of the lot from which a test sample was taken or any similar or identical product unless specifically and expressly noted. Our report includes all of the tests requested by you and the results thereof based upon the information that you provided to us. You have 60 days from date of issuance of this report to notify us of any material error or omission caused by our negligence; provided, however, that such notice shall be in writing and shall specifically address the issue you wish to raise. A failure to raise such issue within the prescribed time shall constitute your unqualified acceptance of the completeness of this report, the tests conducted and the correctness of the report contents.

The content of this PDF file is in accordance with the original issued reports for reference only.  
This Test Report cannot be reproduced, except in full, without prior written permission of the company.

# TEST REPORT



Report No:

(7419)080-0561D(S)

May 16, 2019

Page 2 of 4

## TEST RESULTS

No.	Parameters	Results	LOQ	Unit	Test Method
1	Turbidity*	0.4	-	NTU	APHA 23rd ed: 2017: 2130 B
2	pH at 25°C*	8.0	-	-	APHA 23rd ed: 2017 :4500H <sup>+</sup>
3	Iron (as Fe)*	ND	0.001	mg/l	APHA 23rd ed: 2017: 3125 B
4	Manganese (as Mn)	ND	0.001	mg/l	APHA 23rd ed: 2017: 3125 B
5	Arsenic ( as As)	ND	0.001	mg/l	APHA 23rd ed: 2017: 3125 B
6	Total Dissolved Solids*	1003	-	mg/l	APHA 23rd ed: 2017: 2540 C
7	Electrical Conductivity at 25°C*	1.87	-	mS/cm	APHA 23rd ed: 2017; 2510 B
8	Cadmium (as Cd)*	ND	0.0001	mg/l	APHA 23rd ed: 2017: 3125 B
9	Lead (as Pb)*	ND	0.001	mg/l	
10	Mercury (as Hg)	ND	0.00005	mg/l	
11	<b>Polynuclear Aromatic Hydrocarbons*</b>				
a	Naphthalene	ND	1.0	µg/l	CPSD –AN-00576
b	Acenaphthylene	ND	1.0	µg/l	CPSD –AN-00576
c	Acenaphthene	ND	1.0	µg/l	CPSD –AN-00576
d	Fluorene	ND	1.0	µg/l	CPSD –AN-00576
e	Phenanthrene	ND	1.0	µg/l	CPSD –AN-00576
f	Anthracene	ND	1.0	µg/l	CPSD –AN-00576
g	Fluoranthene	ND	1.0	µg/l	CPSD –AN-00576
h	Pyrene	ND	1.0	µg/l	CPSD –AN-00576
i	Benzo[a]anthracene	ND	1.0	µg/l	CPSD –AN-00576
j	Chrysene	ND	1.0	µg/l	CPSD –AN-00576
k	Benzo[a]pyrene	ND	1.0	µg/l	CPSD –AN-00576
l	Benzo[e]pyrene	ND	1.0	µg/l	CPSD –AN-00576
m	Indeno[1,2,3-cd]pyrene	ND	1.0	µg/l	CPSD –AN-00576
n	Dibenzo[a,h]anthracene	ND	1.0	µg/l	CPSD –AN-00576
o	Benzo[g,h,i]perylene	ND	1.0	µg/l	CPSD –AN-00576
p	Benzo[b]fluoranthene	ND	1.0	µg/l	CPSD –AN-00576
q	Benzo[j]fluoranthene	ND	1.0	µg/l	CPSD –AN-00576
r	Benzo[k]fluoranthene	ND	1.0	µg/l	CPSD –AN-00576

# TEST REPORT



Report No: (7419)080-0561D(S)

May 16, 2019

Page 3 of 4

(\*)Indicates- ISO 17025 :2005 accredited test.

**Remark:**

The test report (7419)080-0561D has been replaced with the test report (7419)080-0561D(S) in order to add test results of Heavy metals.

**NOTE:**

APHA: American Public Health Association,  
SLS: Sri Lanka Standard, ND: Not Detected,  
LOQ: Limit of Quantification, mg/l: milligrams per liter,  
°C :Celcius, NTU: Nephelometric Turbidity Units,  
mS/cm : milliSiemens per centimeter.

**Contact Information for this report (Technical and General Inquiries and Feedback)**

<b>GENERAL INQUIRIES:</b>		
IROSHA UDUGAMPALA	TEL: +94 768 229 528	E-MAIL: Irosha.Udugampala@lk.bureauveritas.com
<b>TECHNICAL INQUIRIES:</b>		
ROHITHA GUNARATHNA	TEL: +94 774 151 768	E-MAIL: rohitha.gunarathna@lk.bureauveritas.com
<b>FEED BACK:</b>		
KUMUDINI RATHNAYAKE	TEL: +94 768 229 455	E-MAIL: kumudinie.rathnayake@lk.bureauveritas.com

REVIEWED BY: SHYAMIKA WICKRAMASINGHE

BUREAU VERITAS CONSUMER PRODUCTS SERVICES LANKA (PVT) LTD.

AUTHORIZED SIGNATORY

ROHITHA GUNARATHNA

MANAGER-  
ANALYTICAL LABORATORY



# TEST REPORT



Report No:

(7419)080-0561D(S)

May 16, 2019

Page 4 of 4

## CPS CONDITIONS OF SERVICE

The party that submits a completed service request form to Company or signs a quotation issued by the Company for its performance of services ("Services") is the "Client" under these Conditions of Service. The entity within the Bureau Veritas Consumer Products Services division accepting the service request form and issuing the Report documenting the results of those Services is the "Company" under these Conditions of Service. Company and Client are, together, the "Parties" and each is a "Party". A request for Services constitutes a legally binding agreement on both Parties when such a request is accepted by the Company ("Agreement") under the following terms and conditions (collectively, "Conditions").

**1. Services.** (a) The completion of the Services shall be evidenced by the Company's issuing to Client a written report setting forth the results of the Services based upon the properly accepted request, applicable protocols, written information, and where applicable, the product sample provided by Client to Company ("Report"). Company may delegate/assign the performance of all or a portion of the Services to an affiliate of Company or to an agent or subcontractor. Client shall provide to Company on a timely basis, all documents and information necessary to enable Company to properly perform the Services. Company may, in its sole discretion, dispose of product samples furnished to Company for the Services that were not destroyed in the course of performance of the Services. (b) Client represents and warrants to Company that (i) each product sample is not submitted in violation of a third party's intellectual property rights; (ii) Client will not use and rely upon Company's Report for any product whose properties differ from the sample(s) upon which the Report is based; and (iii) any goods subject to inspection will be completely prepared for the type of inspection booked for the specified date, and (c) Client accepts sole responsibility and liability for the accuracy of documents submitted to government or other regulatory bodies, including certificates of compliance required under the US Consumer Product Safety Improvement Act and EU requirements under REACH regulations. Client's responsibility and liability for accuracy shall apply even where Company has provided assistance to Client in preparation of such documentation.

**2. Report.** (a) The Report shall (i) constitute the sole deliverable for the Services, (ii) relate solely to the facts and circumstances as observed and recorded by Company at the time of performance of the Services within the limits of written information and instructions received from Client. Company shall have no obligation to update the Report after its issuance. Where the Services include testing or inspection: (i) the Report will set forth the findings of Company solely with respect to the product samples identified therein and (ii) the results set forth in the Report are not to be construed as indicative or representative of the quality or characteristics of the lot from which a product sample was taken for Company's performance of Services. (b) The Report is issued solely by Company, is intended for the exclusive use of Client and its affiliates and, except as required by a regulatory body, shall not be published, used for advertising purposes, copied or replicated for distribution or publicly disclosed without Company's prior written consent. Company is not responsible for any third party's interpretation of the Report. (c) Client shall not request a Report for purposes of litigation, nor shall it list Company, its affiliates or employees as an expert in any proceeding without Company's prior written consent. If Client anticipates producing or otherwise using the Report in any legal proceedings, it shall so notify Company prior to submitting the Report in such proceeding.

**3. Representations and Warranties.** (a) Company undertakes due care and ordinary skill in the performance of its Services. (b) Client agrees that Company is neither an insurer nor a guarantor and does not take the place of Client or the third parties that it retains, including designers, manufacturers, agents, buyers, distributors, and transportation or shipping companies; Company disclaims all liability in such capacities. Client understands that, if it seeks to protect itself from claims of loss, damage or injury, it should obtain appropriate insurance. (c) Company does not warrant or guarantee Client's products, and Company's Report does not represent a warranty of merchantability, a warranty of fitness for a particular purpose, or any other warranty or guarantee.

**4. Payment.** Payment in full shall be due 30 days after the date of invoice, failing which Company may revoke any credit extended to Client. Client shall reimburse Company for (i) interest on overdue amounts from the due date until paid at an interest rate of 1.5% per month and (ii) any other costs Company incurs in collecting past due amounts, including court, attorneys and collection agencies' fees.

**5. Intellectual Property.** The names, service marks, trademarks and copyrights of Company and its affiliates (collectively, the "Marks") are and remain the sole property of Company and shall not be used by Client. Client shall not contest the validity of the Marks or take any action that might impair the value or goodwill associated with the Marks or the image or reputation of Company or its affiliates. Client understands that any information or samples submitted to Company is a license for Company to use the same in the performance of Services.

**6. Relationship.** (a) Nothing herein creates a partnership, agency or joint venture between the Parties. (b) The failure to require strict observance or performance of any provision of these Conditions shall not be construed to be a waiver of a Party's right to later require strict observance and performance of the same. If any provision of these Conditions is held to be invalid or unenforceable, such invalidity shall not invalidate the remainder of the Conditions. (c) For a period of two years after the commencement of this Agreement, Client shall not directly or indirectly try to solicit for employment any of Company's employees.

**7. INDEMNITY.** CLIENT SHALL HOLD HARMLESS AND INDEMNIFY COMPANY, ITS AFFILIATES AND THEIR RESPECTIVE DIRECTORS, OFFICERS, EMPLOYEES, AGENTS AND SUBCONTRACTORS AGAINST ALL THIRD-PARTY CLAIMS FOR LOSS, DAMAGE, INJURY, DEATH, OR EXPENSE OF WHATEVER NATURE, INCLUDING BUT NOT LIMITED TO CLAIMS ARISING FROM OR RELATING TO (i) THE PERFORMANCE OF ANY SERVICES BY COMPANY, (ii) THE SALE, RESALE, MANUFACTURE, DISTRIBUTION OR USE OF ANY OF CLIENT'S GOODS OR (iii) BREACH OF CLIENT'S OBLIGATIONS OR WARRANTIES HEREIN.

**8. LIMITATIONS OF LIABILITY.** (A) COMPANY SHALL NOT BE LIABLE FOR ANY INDIRECT, CONSEQUENTIAL OR SPECIAL LOSS IN CONNECTION WITH THE REPORT, THE PRODUCT FOR WHICH SERVICES WERE PERFORMED, OR THE SERVICES PROVIDED BY COMPANY HEREUNDER. COMPANY SHALL NOT BE LIABLE FOR ANY LOSS OR DAMAGE WHATSOEVER RESULTING FROM ANY DELAY IN THE PERFORMANCE OF ITS OBLIGATIONS HEREUNDER OR FROM THE FAILURE OF COMPANY TO PROVIDE ITS SERVICES WITHIN ANY TIME PERIOD FOR COMPLETION ESTIMATED BY COMPANY, REGARDLESS OF THE CAUSE OF THE DELAY OR FAILURE. (B) THE ENTIRE FINANCIAL AND LEGAL LIABILITY OF COMPANY IN RESPECT OF ANY CLAIM FOR LOSS, INDEMNITY, CONTRIBUTION OR DAMAGE OF WHATEVER NATURE OR HOWSOEVER ARISING, SHALL NOT EXCEED AN AMOUNT EQUAL TO FIVE (5) TIMES THE AMOUNT OF FEES PAID TO COMPANY FOR THE SPECIFIC SERVICES WHICH GAVE RISE TO SUCH CLAIM.

**9. Force Majeure.** If any event of force majeure or any event outside the control of Company occurs, Company may immediately cancel or suspend its performance hereunder without incurring any liability whatsoever to Client.

**10. Governing Law.** These Conditions shall be governed by the laws of the country as follows: for Services performed in (i) the Americas: the laws of New York, (ii) Asia Pacific, South Asia, Middle East and Africa: the laws of Hong Kong (except for China where PRC laws govern), and (iii) Europe: the laws of England.

**11. Dispute Resolution.** (a) If Client desires to assert a claim relating to the Services, it must submit the same to Company in writing setting forth with particularity the basis for such claim within 90 days from discovery of the claim and not more than six months after the date of issuance of the Report. Client waives any and all claims without limitation that it does not submit within such time periods. (b) If a dispute arises under this Agreement, the Parties shall first attempt good faith negotiations, failing which, the Parties (i) agree that the courts of the country of governing law shall have exclusive jurisdiction to settle any such dispute related to this Agreement and (ii) irrevocably waive their right to trial by jury in any such action or proceeding.

**12.** These Conditions, the applicable order form and/or quotation and the Report represent the entire understanding of the Parties on the subject matter hereof, and no modification is binding unless in writing. Any of Client's terms and conditions attached to, enclosed with or referred to in any order form, purchase order or other document shall not apply.

Gen v.1 copyright 2015 Bureau Veritas

**END OF THE REPORT.**



# TEST REPORT



Report No: (7419)080-0561E(S)

May 16, 2019

Page 1 of 4

Attn: Mr. Nashfa Nashidh

Customer: Water Solutions (Pvt) Ltd

Address : MA. Faseri, 1<sup>st</sup> Floor, Ameenee Magu, Male, Maldives

Date of Sample Received: Apr 03, 2019

Date of Testing Started: Apr 03, 2019

Date of Report Modified: May 16, 2019

Date of Testing Completed: May 16, 2019

Sample Description:

Sample Received as:

Approximately 500ml x 3 Nos. of Water sample contained in two sealed plastic bottles & one glass bottle respectively

Sample Identified by the Client as:

Ground Water

Thilafushi GW 5

Sample Drawn By BVCPS NO

## Photo of the Samples Submitted



**Bureau Veritas Consumer Products Services Lanka (Pvt) Ltd.**

No. 570, Galle Road, Katubedda, Moratuwa, Sri Lanka  
Tel: (9411) 2350111-115 (dedicated lines), Fax: (9411) 112622198 & 199  
Email: [bvcps.lanka@lk.bureauveritas.com](mailto:bvcps.lanka@lk.bureauveritas.com)

This report is governed by, and incorporates by reference, the Conditions of Testing as posted at the date of issuance of this report at <http://www.cps.bureauveritas.com> and is intended for your exclusive use. Any copying or replication of this report to or for any other person or entity, or use of our name or trademark, is permitted only with our prior written permission. This report sets forth our findings solely with respect to the test samples identified herein. The results set forth in this report are not indicative or representative of the quality or characteristics of the lot from which a test sample was taken or any similar or identical product unless specifically and expressly noted. Our report includes all of the tests requested by you and the results thereof based upon the information that you provided to us. You have 60 days from date of issuance of this report to notify us of any material error or omission caused by our negligence; provided, however, that such notice shall be in writing and shall specifically address the issue you wish to raise. A failure to raise such issue within the prescribed time shall constitute your unqualified acceptance of the completeness of this report, the tests conducted and the correctness of the report contents.

The content of this PDF file is in accordance with the original issued reports for reference only.  
This Test Report cannot be reproduced, except in full, without prior written permission of the company.

# TEST REPORT



Report No:

(7419)080-0561E(S)

May 16, 2019

Page 2 of 4

## TEST RESULTS

No.	Parameters	Results	LOQ	Unit	Test Method
1	Turbidity*	151	-	NTU	APHA 23rd ed: 2017: 2130 B
2	pH at 25°C*	7.1	-	-	APHA 23rd ed: 2017 :4500H <sup>+</sup>
3	Iron (as Fe)*	5.9	-	mg/l	APHA 23rd ed: 2017: 3125 B
4	Manganese (as Mn)	0.2	-	mg/l	APHA 23rd ed: 2017: 3125 B
5	Arsenic ( as As)	ND	0.001	mg/l	APHA 23rd ed: 2017: 3125 B
6	Total Dissolved Solids*	6155	-	mg/l	APHA 23rd ed: 2017: 2540 C
7	Electrical Conductivity at 25°C*	12.3	-	mS/cm	APHA 23rd ed: 2017; 2510 B
8	Cadmium (as Cd)*	ND	0.0001	mg/l	APHA 23rd ed: 2017: 3125 B
9	Lead (as Pb)*	ND	0.001	mg/l	
10	Mercury (as Hg)	ND	0.00005	mg/l	
11	<b>Polynuclear Aromatic Hydrocarbons*</b>				
a	Naphthalene	ND	1.0	µg/l	CPSD –AN-00576
b	Acenaphthylene	ND	1.0	µg/l	CPSD –AN-00576
c	Acenaphthene	ND	1.0	µg/l	CPSD –AN-00576
d	Fluorene	ND	1.0	µg/l	CPSD –AN-00576
e	Phenanthrene	ND	1.0	µg/l	CPSD –AN-00576
f	Anthracene	ND	1.0	µg/l	CPSD –AN-00576
g	Fluoranthene	ND	1.0	µg/l	CPSD –AN-00576
h	Pyrene	ND	1.0	µg/l	CPSD –AN-00576
i	Benzo[a]anthracene	ND	1.0	µg/l	CPSD –AN-00576
j	Chrysene	ND	1.0	µg/l	CPSD –AN-00576
k	Benzo[a]pyrene	ND	1.0	µg/l	CPSD –AN-00576
l	Benzo[e]pyrene	ND	1.0	µg/l	CPSD –AN-00576
m	Indeno[1,2,3-cd]pyrene	ND	1.0	µg/l	CPSD –AN-00576
n	Dibenzo[a,h]anthracene	ND	1.0	µg/l	CPSD –AN-00576
o	Benzo[g,h,i]perylene	ND	1.0	µg/l	CPSD –AN-00576
p	Benzo[b]fluoranthene	ND	1.0	µg/l	CPSD –AN-00576
q	Benzo[j]fluoranthene	ND	1.0	µg/l	CPSD –AN-00576
r	Benzo[k]fluoranthene	ND	1.0	µg/l	CPSD –AN-00576

# TEST REPORT



Report No: (7419)080-0561E(S)

May 16, 2019

Page 3 of 4

(\*Indicates- ISO 17025 :2005 accredited test.

**Remark:**

The test report (7419)080-0561E has been replaced with the test report (7419)080-0561E(S) in order to add test results of Heavy metals.

**NOTE:**

APHA: American Public Health Association,  
SLS: Sri Lanka Standard, ND: Not Detected,  
LOQ: Limit of Quantification, mg/l: milligrams per liter,  
°C :Celcius, NTU: Nephelometric Turbidity Units,  
mS/cm : milliSiemens per centimeter.

**Contact Information for this report (Technical and General Inquiries and Feedback)**

<b>GENERAL INQUIRIES:</b>		
IROSHA UDUGAMPALA	TEL: +94 768 229 528	E-MAIL: Irosha.Udugampala@lk.bureauveritas.com
<b>TECHNICAL INQUIRIES:</b>		
ROHITHA GUNARATHNA	TEL: +94 774 151 768	E-MAIL: rohitha.gunarathna@lk.bureauveritas.com
<b>FEED BACK:</b>		
KUMUDINI RATHNAYAKE	TEL: +94 768 229 455	E-MAIL: kumudinie.rathnayake@lk.bureauveritas.com

REVIEWED BY: SHYAMIKA WICKRAMASINGHE

BUREAU VERITAS CONSUMER PRODUCTS SERVICES LANKA (PVT) LTD.

AUTHORIZED SIGNATORY

ROHITHA GUNARATHNA

MANAGER-  
ANALYTICAL LABORATORY

# TEST REPORT



Report No:

(7419)080-0561E(S)

May 16, 2019

Page 4 of 4

## CPS CONDITIONS OF SERVICE

The party that submits a completed service request form to Company or signs a quotation issued by the Company for its performance of services ("Services") is the "Client" under these Conditions of Service. The entity within the Bureau Veritas Consumer Products Services division accepting the service request form and issuing the Report documenting the results of those Services is the "Company" under these Conditions of Service. Company and Client are, together, the "Parties" and each is a "Party". A request for Services constitutes a legally binding agreement on both Parties when such a request is accepted by the Company ("Agreement") under the following terms and conditions (collectively, "Conditions").

**1. Services.** (a) The completion of the Services shall be evidenced by the Company's issuing to Client a written report setting forth the results of the Services based upon the properly accepted request, applicable protocols, written information, and where applicable, the product sample provided by Client to Company ("Report"). Company may delegate/assign the performance of all or a portion of the Services to an affiliate of Company or to an agent or subcontractor. Client shall provide to Company on a timely basis, all documents and information necessary to enable Company to properly perform the Services. Company may, in its sole discretion, dispose of product samples furnished to Company for the Services that were not destroyed in the course of performance of the Services. (b) Client represents and warrants to Company that (i) each product sample is not submitted in violation of a third party's intellectual property rights; (ii) Client will not use and rely upon Company's Report for any product whose properties differ from the sample(s) upon which the Report is based; and (iii) any goods subject to inspection will be completely prepared for the type of inspection booked for the specified date, and (c) Client accepts sole responsibility and liability for the accuracy of documents submitted to government or other regulatory bodies, including certificates of compliance required under the US Consumer Product Safety Improvement Act and EU requirements under REACH regulations. Client's responsibility and liability for accuracy shall apply even where Company has provided assistance to Client in preparation of such documentation.

**2. Report.** (a) The Report shall (i) constitute the sole deliverable for the Services, (ii) relate solely to the facts and circumstances as observed and recorded by Company at the time of performance of the Services within the limits of written information and instructions received from Client. Company shall have no obligation to update the Report after its issuance. Where the Services include testing or inspection: (i) the Report will set forth the findings of Company solely with respect to the product samples identified therein and (ii) the results set forth in the Report are not to be construed as indicative or representative of the quality or characteristics of the lot from which a product sample was taken for Company's performance of Services. (b) The Report is issued solely by Company, is intended for the exclusive use of Client and its affiliates and, except as required by a regulatory body, shall not be published, used for advertising purposes, copied or replicated for distribution or publicly disclosed without Company's prior written consent. Company is not responsible for any third party's interpretation of the Report. (c) Client shall not request a Report for purposes of litigation, nor shall it list Company, its affiliates or employees as an expert in any proceeding without Company's prior written consent. If Client anticipates producing or otherwise using the Report in any legal proceedings, it shall so notify Company prior to submitting the Report in such proceeding.

**3. Representations and Warranties.** (a) Company undertakes due care and ordinary skill in the performance of its Services. (b) Client agrees that Company is neither an insurer nor a guarantor and does not take the place of Client or the third parties that it retains, including designers, manufacturers, agents, buyers, distributors, and transportation or shipping companies; Company disclaims all liability in such capacities. Client understands that, if it seeks to protect itself from claims of loss, damage or injury, it should obtain appropriate insurance. (c) Company does not warrant or guarantee Client's products, and Company's Report does not represent a warranty of merchantability, a warranty of fitness for a particular purpose, or any other warranty or guarantee.

**4. Payment.** Payment in full shall be due 30 days after the date of invoice, failing which Company may revoke any credit extended to Client. Client shall reimburse Company for (i) interest on overdue amounts from the due date until paid at an interest rate of 1.5% per month and (ii) any other costs Company incurs in collecting past due amounts, including court, attorneys and collection agencies' fees.

**5. Intellectual Property.** The names, service marks, trademarks and copyrights of Company and its affiliates (collectively, the "Marks") are and remain the sole property of Company and shall not be used by Client. Client shall not contest the validity of the Marks or take any action that might impair the value or goodwill associated with the Marks or the image or reputation of Company or its affiliates. Client understands that any information or samples submitted to Company is a license for Company to use the same in the performance of Services.

**6. Relationship.** (a) Nothing herein creates a partnership, agency or joint venture between the Parties. (b) The failure to require strict observance or performance of any provision of these Conditions shall not be construed to be a waiver of a Party's right to later require strict observance and performance of the same. If any provision of these Conditions is held to be invalid or unenforceable, such invalidity shall not invalidate the remainder of the Conditions. (c) For a period of two years after the commencement of this Agreement, Client shall not directly or indirectly try to solicit for employment any of Company's employees.

**7. INDEMNITY.** CLIENT SHALL HOLD HARMLESS AND INDEMNIFY COMPANY, ITS AFFILIATES AND THEIR RESPECTIVE DIRECTORS, OFFICERS, EMPLOYEES, AGENTS AND SUBCONTRACTORS AGAINST ALL THIRD-PARTY CLAIMS FOR LOSS, DAMAGE, INJURY, DEATH, OR EXPENSE OF WHATEVER NATURE, INCLUDING BUT NOT LIMITED TO CLAIMS ARISING FROM OR RELATING TO (I) THE PERFORMANCE OF ANY SERVICES BY COMPANY, (II) THE SALE, RESALE, MANUFACTURE, DISTRIBUTION OR USE OF ANY OF CLIENT'S GOODS OR (III) BREACH OF CLIENT'S OBLIGATIONS OR WARRANTIES HEREIN.

**8. LIMITATIONS OF LIABILITY.** (A) COMPANY SHALL NOT BE LIABLE FOR ANY INDIRECT, CONSEQUENTIAL OR SPECIAL LOSS IN CONNECTION WITH THE REPORT, THE PRODUCT FOR WHICH SERVICES WERE PERFORMED, OR THE SERVICES PROVIDED BY COMPANY HEREUNDER. COMPANY SHALL NOT BE LIABLE FOR ANY LOSS OR DAMAGE WHATSOEVER RESULTING FROM ANY DELAY IN THE PERFORMANCE OF ITS OBLIGATIONS HEREUNDER OR FROM THE FAILURE OF COMPANY TO PROVIDE ITS SERVICES WITHIN ANY TIME PERIOD FOR COMPLETION ESTIMATED BY COMPANY, REGARDLESS OF THE CAUSE OF THE DELAY OR FAILURE. (B) THE ENTIRE FINANCIAL AND LEGAL LIABILITY OF COMPANY IN RESPECT OF ANY CLAIM FOR LOSS, INDEMNITY, CONTRIBUTION OR DAMAGE OF WHATEVER NATURE OR HOWSOEVER ARISING, SHALL NOT EXCEED AN AMOUNT EQUAL TO FIVE (5) TIMES THE AMOUNT OF FEES PAID TO COMPANY FOR THE SPECIFIC SERVICES WHICH GAVE RISE TO SUCH CLAIM.

**9. Force Majeure.** If any event of force majeure or any event outside the control of Company occurs, Company may immediately cancel or suspend its performance hereunder without incurring any liability whatsoever to Client.

**10. Governing Law.** These Conditions shall be governed by the laws of the country as follows: for Services performed in (i) the Americas: the laws of New York, (ii) Asia Pacific, South Asia, Middle East and Africa: the laws of Hong Kong (except for China where PRC laws govern), and (iii) Europe: the laws of England.

**11. Dispute Resolution.** (a) If Client desires to assert a claim relating to the Services, it must submit the same to Company in writing setting forth with particularity the basis for such claim within 90 days from discovery of the claim and not more than six months after the date of issuance of the Report. Client waives any and all claims without limitation that it does not submit within such time periods. (b) If a dispute arises under this Agreement, the Parties shall first attempt good faith negotiations, failing which, the Parties (i) agree that the courts of the country of governing law shall have exclusive jurisdiction to settle any such dispute related to this Agreement and (ii) irrevocably waive their right to trial by jury in any such action or proceeding.

**12.** These Conditions, the applicable order form and/or quotation and the Report represent the entire understanding of the Parties on the subject matter hereof, and no modification is binding unless in writing. Any of Client's terms and conditions attached to, enclosed with or referred to in any order form, purchase order or other document shall not apply.

Gen v.1 copyright 2015 Bureau Veritas

**END OF THE REPORT.**



# TEST REPORT



Report No:

(7419)080-0561F(S)

May 16, 2019

Page 1 of 4

Attn: Mr. Nashfa Nashidh

Customer:

Water Solutions (Pvt) Ltd

Address :

MA. Faseri, 1<sup>st</sup> Floor, Ameenee Magu, Male, Maldives

Date of Sample Received:

Apr 03, 2019

Date of Testing Started:

Apr 03, 2019

Date of Report Modified:

May 16, 2019

Date of Testing Completed:

May 16, 2019

Sample Description:

Sample Received as:

Approximately 500ml x 3 Nos. of Water sample contained in two sealed plastic bottles & one glass bottle respectively

Sample Identified by the Client as:

Ground Water

Thilafushi GW 6

Sample Drawn By BVCPS

NO

## Photo of the Samples Submitted



**Bureau Veritas Consumer Products Services Lanka (Pvt) Ltd.**

No. 570, Galle Road, Katubedda, Moratuwa, Sri Lanka  
Tel: (9411) 2350111-115 (dedicated lines), Fax: (9411) 112622198 & 199  
Email: [bvcps.lanka@lk.bureauveritas.com](mailto:bvcps.lanka@lk.bureauveritas.com)

This report is governed by, and incorporates by reference, the Conditions of Testing as posted at the date of issuance of this report at <http://www.cps.bureauveritas.com> and is intended for your exclusive use. Any copying or replication of this report to or for any other person or entity, or use of our name or trademark, is permitted only with our prior written permission. This report sets forth our findings solely with respect to the test samples identified herein. The results set forth in this report are not indicative or representative of the quality or characteristics of the lot from which a test sample was taken or any similar or identical product unless specifically and expressly noted. Our report includes all of the tests requested by you and the results thereof based upon the information that you provided to us. You have 60 days from date of issuance of this report to notify us of any material error or omission caused by our negligence; provided, however, that such notice shall be in writing and shall specifically address the issue you wish to raise. A failure to raise such issue within the prescribed time shall constitute your unqualified acceptance of the completeness of this report, the tests conducted and the correctness of the report contents.

The content of this PDF file is in accordance with the original issued reports for reference only.  
This Test Report cannot be reproduced, except in full, without prior written permission of the company.

# TEST REPORT



Report No:

(7419)080-0561F(S)

May 16, 2019

Page 2 of 4

## TEST RESULTS

No.	Parameters	Results	LOQ	Unit	Test Method
1	Turbidity*	177	-	NTU	APHA 23rd ed: 2017: 2130 B
2	pH at 25°C*	6.7	-	-	APHA 23rd ed: 2017 :4500H <sup>+</sup>
3	Iron (as Fe)*	5.7	-	mg/l	APHA 23rd ed: 2017: 3125 B
4	Manganese (as Mn)	0.3	-	mg/l	APHA 23rd ed: 2017: 3125 B
5	Arsenic ( as As)	ND	0.001	mg/l	APHA 23rd ed: 2017: 3125 B
6	Total Dissolved Solids*	11554	-	mg/l	APHA 23rd ed: 2017: 2540 C
7	Electrical Conductivity at 25°C*	25.0	-	mS/cm	APHA 23rd ed: 2017; 2510 B
8	Cadmium (as Cd)*	ND	0.0001	mg/l	APHA 23rd ed: 2017: 3125 B
9	Lead (as Pb)*	ND	0.001	mg/l	
10	Mercury (as Hg)	ND	0.00005	mg/l	
<b>Polynuclear Aromatic Hydrocarbons*</b>					
a	Naphthalene	ND	1.0	µg/l	CPSD –AN-00576
b	Acenaphthylene	ND	1.0	µg/l	CPSD –AN-00576
c	Acenaphthene	ND	1.0	µg/l	CPSD –AN-00576
d	Fluorene	ND	1.0	µg/l	CPSD –AN-00576
e	Phenanthrene	ND	1.0	µg/l	CPSD –AN-00576
f	Anthracene	ND	1.0	µg/l	CPSD –AN-00576
g	Fluoranthene	ND	1.0	µg/l	CPSD –AN-00576
h	Pyrene	ND	1.0	µg/l	CPSD –AN-00576
i	Benzo[a]anthracene	ND	1.0	µg/l	CPSD –AN-00576
j	Chrysene	ND	1.0	µg/l	CPSD –AN-00576
k	Benzo[a]pyrene	ND	1.0	µg/l	CPSD –AN-00576
l	Benzo[e]pyrene	ND	1.0	µg/l	CPSD –AN-00576
m	Indeno[1,2,3-cd]pyrene	ND	1.0	µg/l	CPSD –AN-00576
n	Dibenzo[a,h]anthracene	ND	1.0	µg/l	CPSD –AN-00576
o	Benzo[g,h,i]perylene	ND	1.0	µg/l	CPSD –AN-00576
p	Benzo[b]fluoranthene	ND	1.0	µg/l	CPSD –AN-00576
q	Benzo[j]fluoranthene	ND	1.0	µg/l	CPSD –AN-00576
r	Benzo[k]fluoranthene	ND	1.0	µg/l	CPSD –AN-00576

# TEST REPORT



Report No: (7419)080-0561F(S)

May 16, 2019

Page 3 of 4

(\*)Indicates- ISO 17025 :2005 accredited test.

**Remark:**

The test report (7419)080-0561F has been replaced with the test report (7419)080-0561F(S) in order to add test results of Heavy metals.

**NOTE:**

APHA: American Public Health Association,  
SLS: Sri Lanka Standard, ND: Not Detected,  
LOQ: Limit of Quantification, mg/l: milligrams per liter,  
°C :Celcius, NTU: Nephelometric Turbidity Units,  
mS/cm : milliSiemens per centimeter.

**Contact Information for this report (Technical and General Inquiries and Feedback)**

<b>GENERAL INQUIRIES:</b>		
IROSHA UDUGAMPALA	TEL: +94 768 229 528	E-MAIL: Irosha.Udugampala@lk.bureauveritas.com
<b>TECHNICAL INQUIRIES:</b>		
ROHITHA GUNARATHNA	TEL: +94 774 151 768	E-MAIL: rohitha.gunarathna@lk.bureauveritas.com
<b>FEED BACK:</b>		
KUMUDINI RATHNAYAKE	TEL: +94 768 229 455	E-MAIL: kumudinie.rathnayake@lk.bureauveritas.com

REVIEWED BY: SHYAMIKA WICKRAMASINGHE

BUREAU VERITAS CONSUMER PRODUCTS SERVICES LANKA (PVT) LTD.

AUTHORIZED SIGNATORY

ROHITHA GUNARATHNA

MANAGER-  
ANALYTICAL LABORATORY



# TEST REPORT



Report No:

(7419)080-0561F(S)

May 16, 2019

Page 4 of 4

## CPS CONDITIONS OF SERVICE

The party that submits a completed service request form to Company or signs a quotation issued by the Company for its performance of services ("Services") is the "Client" under these Conditions of Service. The entity within the Bureau Veritas Consumer Products Services division accepting the service request form and issuing the Report documenting the results of those Services is the "Company" under these Conditions of Service. Company and Client are, together, the "Parties" and each is a "Party". A request for Services constitutes a legally binding agreement on both Parties when such a request is accepted by the Company ("Agreement") under the following terms and conditions (collectively, "Conditions").

**1. Services.** (a) The completion of the Services shall be evidenced by the Company's issuing to Client a written report setting forth the results of the Services based upon the properly accepted request, applicable protocols, written information, and where applicable, the product sample provided by Client to Company ("Report"). Company may delegate/assign the performance of all or a portion of the Services to an affiliate of Company or to an agent or subcontractor. Client shall provide to Company on a timely basis, all documents and information necessary to enable Company to properly perform the Services. Company may, in its sole discretion, dispose of product samples furnished to Company for the Services that were not destroyed in the course of performance of the Services. (b) Client represents and warrants to Company that (i) each product sample is not submitted in violation of a third party's intellectual property rights; (ii) Client will not use and rely upon Company's Report for any product whose properties differ from the sample(s) upon which the Report is based; and (iii) any goods subject to inspection will be completely prepared for the type of inspection booked for the specified date, and (c) Client accepts sole responsibility and liability for the accuracy of documents submitted to government or other regulatory bodies, including certificates of compliance required under the US Consumer Product Safety Improvement Act and EU requirements under REACH regulations. Client's responsibility and liability for accuracy shall apply even where Company has provided assistance to Client in preparation of such documentation.

**2. Report.** (a) The Report shall (i) constitute the sole deliverable for the Services, (ii) relate solely to the facts and circumstances as observed and recorded by Company at the time of performance of the Services within the limits of written information and instructions received from Client. Company shall have no obligation to update the Report after its issuance. Where the Services include testing or inspection: (i) the Report will set forth the findings of Company solely with respect to the product samples identified therein and (ii) the results set forth in the Report are not to be construed as indicative or representative of the quality or characteristics of the lot from which a product sample was taken for Company's performance of Services. (b) The Report is issued solely by Company, is intended for the exclusive use of Client and its affiliates and, except as required by a regulatory body, shall not be published, used for advertising purposes, copied or replicated for distribution or publicly disclosed without Company's prior written consent. Company is not responsible for any third party's interpretation of the Report. (c) Client shall not request a Report for purposes of litigation, nor shall it list Company, its affiliates or employees as an expert in any proceeding without Company's prior written consent. If Client anticipates producing or otherwise using the Report in any legal proceedings, it shall so notify Company prior to submitting the Report in such proceeding.

**3. Representations and Warranties.** (a) Company undertakes due care and ordinary skill in the performance of its Services. (b) Client agrees that Company is neither an insurer nor a guarantor and does not take the place of Client or the third parties that it retains, including designers, manufacturers, agents, buyers, distributors, and transportation or shipping companies; Company disclaims all liability in such capacities. Client understands that, if it seeks to protect itself from claims of loss, damage or injury, it should obtain appropriate insurance. (c) Company does not warrant or guarantee Client's products, and Company's Report does not represent a warranty of merchantability, a warranty of fitness for a particular purpose, or any other warranty or guarantee.

**4. Payment.** Payment in full shall be due 30 days after the date of invoice, failing which Company may revoke any credit extended to Client. Client shall reimburse Company for (i) interest on overdue amounts from the due date until paid at an interest rate of 1.5% per month and (ii) any other costs Company incurs in collecting past due amounts, including court, attorneys and collection agencies' fees.

**5. Intellectual Property.** The names, service marks, trademarks and copyrights of Company and its affiliates (collectively, the "Marks") are and remain the sole property of Company and shall not be used by Client. Client shall not contest the validity of the Marks or take any action that might impair the value or goodwill associated with the Marks or the image or reputation of Company or its affiliates. Client understands that any information or samples submitted to Company is a license for Company to use the same in the performance of Services.

**6. Relationship.** (a) Nothing herein creates a partnership, agency or joint venture between the Parties. (b) The failure to require strict observance or performance of any provision of these Conditions shall not be construed to be a waiver of a Party's right to later require strict observance and performance of the same. If any provision of these Conditions is held to be invalid or unenforceable, such invalidity shall not invalidate the remainder of the Conditions. (c) For a period of two years after the commencement of this Agreement, Client shall not directly or indirectly try to solicit for employment any of Company's employees.

**7. INDEMNITY.** CLIENT SHALL HOLD HARMLESS AND INDEMNIFY COMPANY, ITS AFFILIATES AND THEIR RESPECTIVE DIRECTORS, OFFICERS, EMPLOYEES, AGENTS AND SUBCONTRACTORS AGAINST ALL THIRD-PARTY CLAIMS FOR LOSS, DAMAGE, INJURY, DEATH, OR EXPENSE OF WHATEVER NATURE, INCLUDING BUT NOT LIMITED TO CLAIMS ARISING FROM OR RELATING TO (I) THE PERFORMANCE OF ANY SERVICES BY COMPANY, (II) THE SALE, RESALE, MANUFACTURE, DISTRIBUTION OR USE OF ANY OF CLIENT'S GOODS OR (III) BREACH OF CLIENT'S OBLIGATIONS OR WARRANTIES HEREIN.

**8. LIMITATIONS OF LIABILITY.** (A) COMPANY SHALL NOT BE LIABLE FOR ANY INDIRECT, CONSEQUENTIAL OR SPECIAL LOSS IN CONNECTION WITH THE REPORT, THE PRODUCT FOR WHICH SERVICES WERE PERFORMED, OR THE SERVICES PROVIDED BY COMPANY HEREUNDER. COMPANY SHALL NOT BE LIABLE FOR ANY LOSS OR DAMAGE WHATSOEVER RESULTING FROM ANY DELAY IN THE PERFORMANCE OF ITS OBLIGATIONS HEREUNDER OR FROM THE FAILURE OF COMPANY TO PROVIDE ITS SERVICES WITHIN ANY TIME PERIOD FOR COMPLETION ESTIMATED BY COMPANY, REGARDLESS OF THE CAUSE OF THE DELAY OR FAILURE. (B) THE ENTIRE FINANCIAL AND LEGAL LIABILITY OF COMPANY IN RESPECT OF ANY CLAIM FOR LOSS, INDEMNITY, CONTRIBUTION OR DAMAGE OF WHATEVER NATURE OR HOWSOEVER ARISING, SHALL NOT EXCEED AN AMOUNT EQUAL TO FIVE (5) TIMES THE AMOUNT OF FEES PAID TO COMPANY FOR THE SPECIFIC SERVICES WHICH GAVE RISE TO SUCH CLAIM.

**9. Force Majeure.** If any event of force majeure or any event outside the control of Company occurs, Company may immediately cancel or suspend its performance hereunder without incurring any liability whatsoever to Client.

**10. Governing Law.** These Conditions shall be governed by the laws of the country as follows: for Services performed in (i) the Americas: the laws of New York, (ii) Asia Pacific, South Asia, Middle East and Africa: the laws of Hong Kong (except for China where PRC laws govern), and (iii) Europe: the laws of England.

**11. Dispute Resolution.** (a) If Client desires to assert a claim relating to the Services, it must submit the same to Company in writing setting forth with particularity the basis for such claim within 90 days from discovery of the claim and not more than six months after the date of issuance of the Report. Client waives any and all claims without limitation that it does not submit within such time periods. (b) If a dispute arises under this Agreement, the Parties shall first attempt good faith negotiations, failing which, the Parties (i) agree that the courts of the country of governing law shall have exclusive jurisdiction to settle any such dispute related to this Agreement and (ii) irrevocably waive their right to trial by jury in any such action or proceeding.

**12.** These Conditions, the applicable order form and/or quotation and the Report represent the entire understanding of the Parties on the subject matter hereof, and no modification is binding unless in writing. Any of Client's terms and conditions attached to, enclosed with or referred to in any order form, purchase order or other document shall not apply.

Gen v.1 copyright 2015 Bureau Veritas

**END OF THE REPORT.**



# TEST REPORT



Report No:

(7419)080-0561G(S)

May 16, 2019

Page 1 of 4

Attn: Mr. Nashfa Nashidh

Customer:

Water Solutions (Pvt) Ltd

Address :

MA. Faseri, 1<sup>st</sup> Floor, Ameenee Magu, Male, Maldives

Date of Sample Received:

Apr 03, 2019

Date of Testing Started:

Apr 03, 2019

Date of Report Modified:

May 16, 2019

Date of Testing Completed:

May 16, 2019

Sample Description:

Sample Received as:

Approximately 500ml x 3 Nos. of Water sample contained in two sealed plastic bottles & one glass bottle respectively

Sample Identified by the Client as:

Ground Water

Thilafushi GW 7

Sample Drawn By BVCPS

NO

## Photo of the Samples Submitted



**Bureau Veritas Consumer  
Products Services Lanka (Pvt)  
Ltd.**

No. 570, Galle Road, Katubedda, Moratuwa, Sri Lanka  
Tel: (9411) 2350111-115 (dedicated lines), Fax: (9411)  
112622198 & 199  
Email: [bvcps.lanka@lk.bureauveritas.com](mailto:bvcps.lanka@lk.bureauveritas.com)

This report is governed by, and incorporates by reference, the Conditions of Testing as posted at the date of issuance of this report at <http://www.cps.bureauveritas.com> and is intended for your exclusive use. Any copying or replication of this report to or for any other person or entity, or use of our name or trademark, is permitted only with our prior written permission. This report sets forth our findings solely with respect to the test samples identified herein. The results set forth in this report are not indicative or representative of the quality or characteristics of the lot from which a test sample was taken or any similar or identical product unless specifically and expressly noted. Our report includes all of the tests requested by you and the results thereof based upon the information that you provided to us. You have 60 days from date of issuance of this report to notify us of any material error or omission caused by our negligence; provided, however, that such notice shall be in writing and shall specifically address the issue you wish to raise. A failure to raise such issue within the prescribed time shall constitute your unqualified acceptance of the completeness of this report, the tests conducted and the correctness of the report contents.

The content of this PDF file is in accordance with the original issued reports for reference only.  
This Test Report cannot be reproduced, except in full, without prior written permission of the company.

# TEST REPORT



Report No:

(7419)080-0561G(S)

May 16, 2019

Page 2 of 4

## TEST RESULTS

No.	Parameters	Results	LOQ	Unit	Test Method
1	Turbidity*	1845	-	NTU	APHA 23rd ed: 2017: 2130 B
2	pH at 25°C*	7.9	-	-	APHA 23rd ed: 2017 :4500H <sup>+</sup>
3	Iron (as Fe)*	0.7	-	mg/l	APHA 23rd ed: 2017: 3125 B
4	Manganese (as Mn)	0.01	-	mg/l	APHA 23rd ed: 2017: 3125 B
5	Arsenic ( as As)	ND	0.001	mg/l	APHA 23rd ed: 2017: 3125 B
6	Total Dissolved Solids*	11327	-	mg/l	APHA 23rd ed: 2017: 2540 C
7	Electrical Conductivity at 25°C*	18.7	-	mS/cm	APHA 23rd ed: 2017; 2510 B
8	Cadmium (as Cd)*	ND	0.0001	mg/l	APHA 23rd ed: 2017: 3125 B
9	Lead (as Pb)*	ND	0.001	mg/l	
10	Mercury (as Hg)	ND	0.00005	mg/l	
11	<b>Polynuclear Aromatic Hydrocarbons*</b>				
a	Naphthalene	ND	1.0	µg/l	CPSD –AN-00576
b	Acenaphthylene	ND	1.0	µg/l	CPSD –AN-00576
c	Acenaphthene	ND	1.0	µg/l	CPSD –AN-00576
d	Fluorene	ND	1.0	µg/l	CPSD –AN-00576
e	Phenanthrene	ND	1.0	µg/l	CPSD –AN-00576
f	Anthracene	ND	1.0	µg/l	CPSD –AN-00576
g	Fluoranthene	ND	1.0	µg/l	CPSD –AN-00576
h	Pyrene	ND	1.0	µg/l	CPSD –AN-00576
i	Benzo[a]anthracene	ND	1.0	µg/l	CPSD –AN-00576
j	Chrysene	ND	1.0	µg/l	CPSD –AN-00576
k	Benzo[a]pyrene	ND	1.0	µg/l	CPSD –AN-00576
l	Benzo[e]pyrene	ND	1.0	µg/l	CPSD –AN-00576
m	Indeno[1,2,3-cd]pyrene	ND	1.0	µg/l	CPSD –AN-00576
n	Dibenzo[a,h]anthracene	ND	1.0	µg/l	CPSD –AN-00576
o	Benzo[g,h,i]perylene	ND	1.0	µg/l	CPSD –AN-00576
p	Benzo[b]fluoranthene	ND	1.0	µg/l	CPSD –AN-00576
q	Benzo[j]fluoranthene	ND	1.0	µg/l	CPSD –AN-00576
r	Benzo[k]fluoranthene	ND	1.0	µg/l	CPSD –AN-00576

# TEST REPORT



Report No: (7419)080-0561G(S)

May 16, 2019

Page 3 of 4

(\*)Indicates- ISO 17025 :2005 accredited test.

**Remark:**

The test report (7419)080-0561G has been replaced with the test report (7419)080-0561G(S) in order to add test results of Heavy metals.

**NOTE:**

APHA: American Public Health Association,  
SLS: Sri Lanka Standard, ND: Not Detected,  
LOQ: Limit of Quantification, mg/l: milligrams per liter,  
°C :Celcius, NTU: Nephelometric Turbidity Units,  
mS/cm : milliSiemens per centimeter.

**Contact Information for this report (Technical and General Inquiries and Feedback)**

<b>GENERAL INQUIRIES:</b>		
IROSHA UDUGAMPALA	TEL: +94 768 229 528	E-MAIL: Irosha.Udugampala@lk.bureauveritas.com
<b>TECHNICAL INQUIRIES:</b>		
ROHITHA GUNARATHNA	TEL: +94 774 151 768	E-MAIL: rohitha.gunarathna@lk.bureauveritas.com
<b>FEED BACK:</b>		
KUMUDINI RATHNAYAKE	TEL: +94 768 229 455	E-MAIL: kumudinie.rathnayake@lk.bureauveritas.com

REVIEWED BY: SHYAMIKA WICKRAMASINGHE

BUREAU VERITAS CONSUMER PRODUCTS SERVICES LANKA (PVT) LTD.

AUTHORIZED SIGNATORY

ROHITHA GUNARATHNA

MANAGER-  
ANALYTICAL LABORATORY

# TEST REPORT



Report No:

(7419)080-0561G(S)

May 16, 2019

Page 4 of 4

## CPS CONDITIONS OF SERVICE

The party that submits a completed service request form to Company or signs a quotation issued by the Company for its performance of services ("Services") is the "Client" under these Conditions of Service. The entity within the Bureau Veritas Consumer Products Services division accepting the service request form and issuing the Report documenting the results of those Services is the "Company" under these Conditions of Service. Company and Client are, together, the "Parties" and each is a "Party". A request for Services constitutes a legally binding agreement on both Parties when such a request is accepted by the Company ("Agreement") under the following terms and conditions (collectively, "Conditions").

**1. Services.** (a) The completion of the Services shall be evidenced by the Company's issuing to Client a written report setting forth the results of the Services based upon the properly accepted request, applicable protocols, written information, and where applicable, the product sample provided by Client to Company ("Report"). Company may delegate/assign the performance of all or a portion of the Services to an affiliate of Company or to an agent or subcontractor. Client shall provide to Company on a timely basis, all documents and information necessary to enable Company to properly perform the Services. Company may, in its sole discretion, dispose of product samples furnished to Company for the Services that were not destroyed in the course of performance of the Services. (b) Client represents and warrants to Company that (i) each product sample is not submitted in violation of a third party's intellectual property rights; (ii) Client will not use and rely upon Company's Report for any product whose properties differ from the sample(s) upon which the Report is based; and (iii) any goods subject to inspection will be completely prepared for the type of inspection booked for the specified date, and (c) Client accepts sole responsibility and liability for the accuracy of documents submitted to government or other regulatory bodies, including certificates of compliance required under the US Consumer Product Safety Improvement Act and EU requirements under REACH regulations. Client's responsibility and liability for accuracy shall apply even where Company has provided assistance to Client in preparation of such documentation.

**2. Report.** (a) The Report shall (i) constitute the sole deliverable for the Services, (ii) relate solely to the facts and circumstances as observed and recorded by Company at the time of performance of the Services within the limits of written information and instructions received from Client; Company shall have no obligation to update the Report after its issuance. Where the Services include testing or inspection: (i) the Report will set forth the findings of Company solely with respect to the product samples identified therein and (ii) the results set forth in the Report are not to be construed as indicative or representative of the quality or characteristics of the lot from which a product sample was taken for Company's performance of Services. (b) The Report is issued solely by Company, is intended for the exclusive use of Client and its affiliates and, except as required by a regulatory body, shall not be published, used for advertising purposes, copied or replicated for distribution or publicly disclosed without Company's prior written consent. Company is not responsible for any third party's interpretation of the Report. (c) Client shall not request a Report for purposes of litigation, nor shall it list Company, its affiliates or employees as an expert in any proceeding without Company's prior written consent. If Client anticipates producing or otherwise using the Report in any legal proceedings, it shall so notify Company prior to submitting the Report in such proceeding.

**3. Representations and Warranties.** (a) Company undertakes due care and ordinary skill in the performance of its Services. (b) Client agrees that Company is neither an insurer nor a guarantor and does not take the place of Client or the third parties that it retains, including designers, manufacturers, agents, buyers, distributors, and transportation or shipping companies; Company disclaims all liability in such capacities. Client understands that, if it seeks to protect itself from claims of loss, damage or injury, it should obtain appropriate insurance. (c) Company does not warrant or guarantee Client's products, and Company's Report does not represent a warranty of merchantability, a warranty of fitness for a particular purpose, or any other warranty or guarantee.

**4. Payment.** Payment in full shall be due 30 days after the date of invoice, failing which Company may revoke any credit extended to Client. Client shall reimburse Company for (i) interest on overdue amounts from the due date until paid at an interest rate of 1.5% per month and (ii) any other costs Company incurs in collecting past due amounts, including court, attorneys and collection agencies' fees.

**5. Intellectual Property.** The names, service marks, trademarks and copyrights of Company and its affiliates (collectively, the "Marks") are and remain the sole property of Company and shall not be used by Client. Client shall not contest the validity of the Marks or take any action that might impair the value or goodwill associated with the Marks or the image or reputation of Company or its affiliates. Client understands that any information or samples submitted to Company is a license for Company to use the same in the performance of Services.

**6. Relationship.** (a) Nothing herein creates a partnership, agency or joint venture between the Parties. (b) The failure to require strict observance or performance of any provision of these Conditions shall not be construed to be a waiver of a Party's right to later require strict observance and performance of the same. If any provision of these Conditions is held to be invalid or unenforceable, such invalidity shall not invalidate the remainder of the Conditions. (c) For a period of two years after the commencement of this Agreement, Client shall not directly or indirectly try to solicit for employment any of Company's employees.

**7. INDEMNITY.** CLIENT SHALL HOLD HARMLESS AND INDEMNIFY COMPANY, ITS AFFILIATES AND THEIR RESPECTIVE DIRECTORS, OFFICERS, EMPLOYEES, AGENTS AND SUBCONTRACTORS AGAINST ALL THIRD-PARTY CLAIMS FOR LOSS, DAMAGE, INJURY, DEATH, OR EXPENSE OF WHATEVER NATURE, INCLUDING BUT NOT LIMITED TO CLAIMS ARISING FROM OR RELATING TO (I) THE PERFORMANCE OF ANY SERVICES BY COMPANY, (II) THE SALE, RESALE, MANUFACTURE, DISTRIBUTION OR USE OF ANY OF CLIENT'S GOODS OR (III) BREACH OF CLIENT'S OBLIGATIONS OR WARRANTIES HEREIN.

**8. LIMITATIONS OF LIABILITY.** (A) COMPANY SHALL NOT BE LIABLE FOR ANY INDIRECT, CONSEQUENTIAL OR SPECIAL LOSS IN CONNECTION WITH THE REPORT, THE PRODUCT FOR WHICH SERVICES WERE PERFORMED, OR THE SERVICES PROVIDED BY COMPANY HEREUNDER. COMPANY SHALL NOT BE LIABLE FOR ANY LOSS OR DAMAGE WHATSOEVER RESULTING FROM ANY DELAY IN THE PERFORMANCE OF ITS OBLIGATIONS HEREUNDER OR FROM THE FAILURE OF COMPANY TO PROVIDE ITS SERVICES WITHIN ANY TIME PERIOD FOR COMPLETION ESTIMATED BY COMPANY, REGARDLESS OF THE CAUSE OF THE DELAY OR FAILURE. (B) THE ENTIRE FINANCIAL AND LEGAL LIABILITY OF COMPANY IN RESPECT OF ANY CLAIM FOR LOSS, INDEMNITY, CONTRIBUTION OR DAMAGE OF WHATEVER NATURE OR HOWSOEVER ARISING, SHALL NOT EXCEED AN AMOUNT EQUAL TO FIVE (5) TIMES THE AMOUNT OF FEES PAID TO COMPANY FOR THE SPECIFIC SERVICES WHICH GAVE RISE TO SUCH CLAIM.

**9. Force Majeure.** If any event of force majeure or any event outside the control of Company occurs, Company may immediately cancel or suspend its performance hereunder without incurring any liability whatsoever to Client.

**10. Governing Law.** These Conditions shall be governed by the laws of the country as follows: for Services performed in (i) the Americas: the laws of New York, (ii) Asia Pacific, South Asia, Middle East and Africa: the laws of Hong Kong (except for China where PRC laws govern), and (iii) Europe: the laws of England.

**11. Dispute Resolution.** (a) If Client desires to assert a claim relating to the Services, it must submit the same to Company in writing setting forth with particularity the basis for such claim within 90 days from discovery of the claim and not more than six months after the date of issuance of the Report. Client waives any and all claims without limitation that it does not submit within such time periods. (b) If a dispute arises under this Agreement, the Parties shall first attempt good faith negotiations, failing which, the Parties (i) agree that the courts of the country of governing law shall have exclusive jurisdiction to settle any such dispute related to this Agreement and (ii) irrevocably waive their right to trial by jury in any such action or proceeding.

**12.** These Conditions, the applicable order form and/or quotation and the Report represent the entire understanding of the Parties on the subject matter hereof, and no modification is binding unless in writing. Any of Client's terms and conditions attached to, enclosed with or referred to in any order form, purchase order or other document shall not apply.

Gen v.1 copyright 2015 Bureau Veritas

END OF THE REPORT.



# TEST REPORT



Report No:

(7419)080-0561H(S)

May 16, 2019

Page 1 of 4

Attn: Mr. Nashfa Nashidh

Customer:

Water Solutions (Pvt) Ltd

Address :

MA. Faseri, 1<sup>st</sup> Floor, Ameene Magu, Male, Maldives

Date of Sample Received:

Apr 03, 2019

Date of Testing Started:

Apr 03, 2019

Date of Report Modified:

May 16, 2019

Date of Testing Completed:

May 16, 2019

Sample Description:

Sample Received as:

Approximately 500ml x 3 Nos. of Water sample contained in two sealed plastic bottles & one glass bottle respectively

Sample Identified by the Client as:

Ground Water

Thilafushi GW 8

Sample Drawn By BVCPS

NO

## Photo of the Samples Submitted



**Bureau Veritas Consumer  
Products Services Lanka (Pvt)  
Ltd.**

No. 570, Galle Road, Katubedda, Moratuwa, Sri Lanka  
Tel: (9411) 2350111-115 (dedicated lines), Fax: (9411)  
112622198 & 199  
Email: [bvcps.lanka@lk.bureauveritas.com](mailto:bvcps.lanka@lk.bureauveritas.com)

This report is governed by, and incorporates by reference, the Conditions of Testing as posted at the date of issuance of this report at <http://www.cps.bureauveritas.com> and is intended for your exclusive use. Any copying or replication of this report to or for any other person or entity, or use of our name or trademark, is permitted only with our prior written permission. This report sets forth our findings solely with respect to the test samples identified herein. The results set forth in this report are not indicative or representative of the quality or characteristics of the lot from which a test sample was taken or any similar or identical product unless specifically and expressly noted. Our report includes all of the tests requested by you and the results thereof based upon the information that you provided to us. You have 60 days from date of issuance of this report to notify us of any material error or omission caused by our negligence; provided, however, that such notice shall be in writing and shall specifically address the issue you wish to raise. A failure to raise such issue within the prescribed time shall constitute your unqualified acceptance of the completeness of this report, the tests conducted and the correctness of the report contents.

The content of this PDF file is in accordance with the original issued reports for reference only.  
This Test Report cannot be reproduced, except in full, without prior written permission of the company.

# TEST REPORT



Report No:

(7419)080-0561H(S)

May 16, 2019

Page 2 of 4

## TEST RESULTS

No.	Parameters	Results	LOQ	Unit	Test Method
1	Turbidity*	348	-	NTU	APHA 23rd ed: 2017: 2130 B
2	pH at 25°C*	7.8	-	-	APHA 23rd ed: 2017 :4500H <sup>+</sup>
3	Iron (as Fe)*	0.4	-	mg/l	APHA 23rd ed: 2017: 3125 B
4	Manganese (as Mn)	0.07	-	mg/l	APHA 23rd ed: 2017: 3125 B
5	Arsenic ( as As)	ND	0.001	mg/l	APHA 23rd ed: 2017: 3125 B
6	Total Dissolved Solids*	2188	-	mg/l	APHA 23rd ed: 2017: 2540 C
7	Electrical Conductivity at 25°C*	3.8	-	mS/cm	APHA 23rd ed: 2017; 2510 B
8	Cadmium (as Cd)*	ND	0.0001	mg/l	APHA 23rd ed: 2017: 3125 B
9	Lead (as Pb)*	ND	0.001	mg/l	
10	Mercury (as Hg)	ND	0.00005	mg/l	
11	<b>Polynuclear Aromatic Hydrocarbons*</b>				
a	Naphthalene	ND	1.0	µg/l	CPSD –AN-00576
b	Acenaphthylene	ND	1.0	µg/l	CPSD –AN-00576
c	Acenaphthene	ND	1.0	µg/l	CPSD –AN-00576
d	Fluorene	ND	1.0	µg/l	CPSD –AN-00576
e	Phenanthrene	ND	1.0	µg/l	CPSD –AN-00576
f	Anthracene	ND	1.0	µg/l	CPSD –AN-00576
g	Fluoranthene	ND	1.0	µg/l	CPSD –AN-00576
h	Pyrene	ND	1.0	µg/l	CPSD –AN-00576
i	Benzo[a]anthracene	ND	1.0	µg/l	CPSD –AN-00576
j	Chrysene	ND	1.0	µg/l	CPSD –AN-00576
k	Benzo[a]pyrene	ND	1.0	µg/l	CPSD –AN-00576
l	Benzo[e]pyrene	ND	1.0	µg/l	CPSD –AN-00576
m	Indeno[1,2,3-cd]pyrene	ND	1.0	µg/l	CPSD –AN-00576
n	Dibenzo[a,h]anthracene	ND	1.0	µg/l	CPSD –AN-00576
o	Benzo[g,h,i]perylene	ND	1.0	µg/l	CPSD –AN-00576
p	Benzo[b]fluoranthene	ND	1.0	µg/l	CPSD –AN-00576
q	Benzo[j]fluoranthene	ND	1.0	µg/l	CPSD –AN-00576
r	Benzo[k]fluoranthene	ND	1.0	µg/l	CPSD –AN-00576

# TEST REPORT



Report No:

(7419)080-0561H(S)

May 16, 2019

Page 3 of 4

(\*Indicates- ISO 17025 :2005 accredited test.

**Remark:**

The test report (7419)080-0561H has been replaced with the test report (7419)080-0561H(S) in order to add test results of Heavy metals.

**NOTE:**

APHA: American Public Health Association,  
SLS: Sri Lanka Standard, ND: Not Detected,  
LOQ: Limit of Quantification, mg/l: milligrams per liter,  
°C :Celcius, NTU: Nephelometric Turbidity Units,  
mS/cm : milliSiemens per centimeter.

**Contact Information for this report (Technical and General Inquiries and Feedback)**

<b>GENERAL INQUIRIES:</b>		
IROSHA UDUGAMPALA	TEL: +94 768 229 528	E-MAIL: Irosha.Udugampala@lk.bureauveritas.com
<b>TECHNICAL INQUIRIES:</b>		
ROHITHA GUNARATHNA	TEL: +94 774 151 768	E-MAIL: rohitha.gunarathna@lk.bureauveritas.com
<b>FEED BACK:</b>		
KUMUDINI RATHNAYAKE	TEL: +94 768 229 455	E-MAIL: kumudinie.rathnayake@lk.bureauveritas.com

REVIEWED BY: SHYAMIKA WICKRAMASINGHE

BUREAU VERITAS CONSUMER PRODUCTS SERVICES LANKA (PVT) LTD.

AUTHORIZED SIGNATORY

ROHITHA GUNARATHNA

MANAGER-  
ANALYTICAL LABORATORY



# TEST REPORT



Report No:

(7419)080-0561H(S)

May 16, 2019

Page 4 of 4

## CPS CONDITIONS OF SERVICE

The party that submits a completed service request form to Company or signs a quotation issued by the Company for its performance of services ("Services") is the "Client" under these Conditions of Service. The entity within the Bureau Veritas Consumer Products Services division accepting the service request form and issuing the Report documenting the results of those Services is the "Company" under these Conditions of Service. Company and Client are, together, the "Parties" and each is a "Party". A request for Services constitutes a legally binding agreement on both Parties when such a request is accepted by the Company ("Agreement") under the following terms and conditions (collectively, "Conditions").

**1. Services.** (a) The completion of the Services shall be evidenced by the Company's issuing to Client a written report setting forth the results of the Services based upon the properly accepted request, applicable protocols, written information, and where applicable, the product sample provided by Client to Company ("Report"). Company may delegate/assign the performance of all or a portion of the Services to an affiliate of Company or to an agent or subcontractor. Client shall provide to Company on a timely basis, all documents and information necessary to enable Company to properly perform the Services. Company may, in its sole discretion, dispose of product samples furnished to Company for the Services that were not destroyed in the course of performance of the Services. (b) Client represents and warrants to Company that (i) each product sample is not submitted in violation of a third party's intellectual property rights; (ii) Client will not use and rely upon Company's Report for any product whose properties differ from the sample(s) upon which the Report is based; and (iii) any goods subject to inspection will be completely prepared for the type of inspection booked for the specified date, and (c) Client accepts sole responsibility and liability for the accuracy of documents submitted to government or other regulatory bodies, including certificates of compliance required under the US Consumer Product Safety Improvement Act and EU requirements under REACH regulations. Client's responsibility and liability for accuracy shall apply even where Company has provided assistance to Client in preparation of such documentation.

**2. Report.** (a) The Report shall (i) constitute the sole deliverable for the Services, (ii) relate solely to the facts and circumstances as observed and recorded by Company at the time of performance of the Services within the limits of written information and instructions received from Client. Company shall have no obligation to update the Report after its issuance. Where the Services include testing or inspection: (i) the Report will set forth the findings of Company solely with respect to the product samples identified therein and (ii) the results set forth in the Report are not to be construed as indicative or representative of the quality or characteristics of the lot from which a product sample was taken for Company's performance of Services. (b) The Report is issued solely by Company, is intended for the exclusive use of Client and its affiliates and, except as required by a regulatory body, shall not be published, used for advertising purposes, copied or replicated for distribution or publicly disclosed without Company's prior written consent. Company is not responsible for any third party's interpretation of the Report. (c) Client shall not request a Report for purposes of litigation, nor shall it list Company, its affiliates or employees as an expert in any proceeding without Company's prior written consent. If Client anticipates producing or otherwise using the Report in any legal proceedings, it shall so notify Company prior to submitting the Report in such proceeding.

**3. Representations and Warranties.** (a) Company undertakes due care and ordinary skill in the performance of its Services. (b) Client agrees that Company is neither an insurer nor a guarantor and does not take the place of Client or the third parties that it retains, including designers, manufacturers, agents, buyers, distributors, and transportation or shipping companies; Company disclaims all liability in such capacities. Client understands that, if it seeks to protect itself from claims of loss, damage or injury, it should obtain appropriate insurance. (c) Company does not warrant or guarantee Client's products, and Company's Report does not represent a warranty of merchantability, a warranty of fitness for a particular purpose, or any other warranty or guarantee.

**4. Payment.** Payment in full shall be due 30 days after the date of invoice, failing which Company may revoke any credit extended to Client. Client shall reimburse Company for (i) interest on overdue amounts from the due date until paid at an interest rate of 1.5% per month and (ii) any other costs Company incurs in collecting past due amounts, including court, attorneys and collection agencies' fees.

**5. Intellectual Property.** The names, service marks, trademarks and copyrights of Company and its affiliates (collectively, the "Marks") are and remain the sole property of Company and shall not be used by Client. Client shall not contest the validity of the Marks or take any action that might impair the value or goodwill associated with the Marks or the image or reputation of Company or its affiliates. Client understands that any information or samples submitted to Company is a license for Company to use the same in the performance of Services.

**6. Relationship.** (a) Nothing herein creates a partnership, agency or joint venture between the Parties. (b) The failure to require strict observance or performance of any provision of these Conditions shall not be construed to be a waiver of a Party's right to later require strict observance and performance of the same. If any provision of these Conditions is held to be invalid or unenforceable, such invalidity shall not invalidate the remainder of the Conditions. (c) For a period of two years after the commencement of this Agreement, Client shall not directly or indirectly try to solicit for employment any of Company's employees.

**7. INDEMNITY.** CLIENT SHALL HOLD HARMLESS AND INDEMNIFY COMPANY, ITS AFFILIATES AND THEIR RESPECTIVE DIRECTORS, OFFICERS, EMPLOYEES, AGENTS AND SUBCONTRACTORS AGAINST ALL THIRD-PARTY CLAIMS FOR LOSS, DAMAGE, INJURY, DEATH, OR EXPENSE OF WHATEVER NATURE, INCLUDING BUT NOT LIMITED TO CLAIMS ARISING FROM OR RELATING TO (i) THE PERFORMANCE OF ANY SERVICES BY COMPANY, (ii) THE SALE, RESALE, MANUFACTURE, DISTRIBUTION OR USE OF ANY OF CLIENT'S GOODS OR (iii) BREACH OF CLIENT'S OBLIGATIONS OR WARRANTIES HEREIN.

**8. LIMITATIONS OF LIABILITY.** (A) COMPANY SHALL NOT BE LIABLE FOR ANY INDIRECT, CONSEQUENTIAL OR SPECIAL LOSS IN CONNECTION WITH THE REPORT, THE PRODUCT FOR WHICH SERVICES WERE PERFORMED, OR THE SERVICES PROVIDED BY COMPANY HEREUNDER. COMPANY SHALL NOT BE LIABLE FOR ANY LOSS OR DAMAGE WHATSOEVER RESULTING FROM ANY DELAY IN THE PERFORMANCE OF ITS OBLIGATIONS HEREUNDER OR FROM THE FAILURE OF COMPANY TO PROVIDE ITS SERVICES WITHIN ANY TIME PERIOD FOR COMPLETION ESTIMATED BY COMPANY, REGARDLESS OF THE CAUSE OF THE DELAY OR FAILURE. (B) THE ENTIRE FINANCIAL AND LEGAL LIABILITY OF COMPANY IN RESPECT OF ANY CLAIM FOR LOSS, INDEMNITY, CONTRIBUTION OR DAMAGE OF WHATEVER NATURE OR HOWSOEVER ARISING, SHALL NOT EXCEED AN AMOUNT EQUAL TO FIVE (5) TIMES THE AMOUNT OF FEES PAID TO COMPANY FOR THE SPECIFIC SERVICES WHICH GAVE RISE TO SUCH CLAIM.

**9. Force Majeure.** If any event of force majeure or any event outside the control of Company occurs, Company may immediately cancel or suspend its performance hereunder without incurring any liability whatsoever to Client.

**10. Governing Law.** These Conditions shall be governed by the laws of the country as follows: for Services performed in (i) the Americas: the laws of New York, (ii) Asia Pacific, South Asia, Middle East and Africa: the laws of Hong Kong (except for China where PRC laws govern), and (iii) Europe: the laws of England.

**11. Dispute Resolution.** (a) If Client desires to assert a claim relating to the Services, it must submit the same to Company in writing setting forth with particularity the basis for such claim within 90 days from discovery of the claim and not more than six months after the date of issuance of the Report. Client waives any and all claims without limitation that it does not submit within such time periods. (b) If a dispute arises under this Agreement, the Parties shall first attempt good faith negotiations, failing which, the Parties (i) agree that the courts of the country of governing law shall have exclusive jurisdiction to settle any such dispute related to this Agreement and (ii) irrevocably waive their right to trial by jury in any such action or proceeding.

**12.** These Conditions, the applicable order form and/or quotation and the Report represent the entire understanding of the Parties on the subject matter hereof, and no modification is binding unless in writing. Any of Client's terms and conditions attached to, enclosed with or referred to in any order form, purchase order or other document shall not apply.

Gen v.1 copyright 2015 Bureau Veritas

**END OF THE REPORT.**

**WATER QUALITY TEST REPORT**  
 Report No: 500181970

**Customer Information:**  
 Water Solutions Pvt Ltd

Ionuziyaaraiy magu  
 Male' 20063

Report date: **09/04/2019**  
 Test Requisition Form No: **900187119**  
 Sample(s) Received Date: **03/04/2019**  
 Date of Analysis: **03/04/2019 - 04/04/2019**

Sample Description	Thilafushi GW1	Thilafushi GW2	Thilafushi GW3	TEST METHOD	UNIT		
Sample Type	Ground Water	Ground Water	Ground Water				
Sample No	83203941	83203942	83203943				
Sampled Date	02/04/2019	02/04/2019	02/04/2019				
PARAMETER	ANALYSIS RESULT						
Physical Appearance	Clear	Pale brown with particles	Pale yellow with particles				
Chloride	183	1715	7200	In-house Test method (Adapted from M926 Chloride analyzer Operation Manual)	mg/L		
Nitrate *	1.7	6.1	5.0	Method 8171 (Adapted from HACH DR5000 Spectrophotometer procedure Manual)	mg/L		
Phosphate *	0.07	0.23	0.21	Method 8048 (Adapted from HACH DR5000 Spectrophotometer procedure Manual)	mg/L		
Total Coliforms	>2420	291	>2420	ColiIert®-18/Quanti-Tray®2000	MPN/100ml		

**Keys:** mg/L : Milligram Per Liter, MPN/100ml : Most Probable Number

Checked by



Aminath Sofa  
 Laboratory Executive

Approved by



Mohamed Eyman  
 Assistant Manager, Quality

**Notes: Sampling Authority:** Sampling was not done by MWSC Laboratory  
 This report shall not be reproduced except in full, without written approval of MWSC  
 This test report is ONLY FOR THE SAMPLES TESTED.  
 ~ Information provided by the customer  
 \*Parametres accredited by DAC under ISO / IEC 17025:2005

**WATER QUALITY TEST REPORT**  
 Report No: 500181970

**Customer Information:**  
 Water Solutions Pvt Ltd

Ionuziyaarayi magu  
 Male' 20063

Report date: 09/04/2019  
 Test Requisition Form No: 900187119  
 Sample(s) Received Date: 03/04/2019  
 Date of Analysis: 03/04/2019 - 04/04/2019

Sample Description	Thilafushi GW4	Thilafushi GW5	Thilafushi GW6	TEST METHOD	UNIT
Sample Type	Ground Water	Ground Water	Ground Water		
Sample No	83203944	83203945	83203946		
Sampled Date	02/04/2019	02/04/2019	02/04/2019		
PARAMETER	ANALYSIS RESULT				
Physical Appearance	Pale yellow with particles	Olive green with particles	Olive green with particles		
Chloride	470	3125	6325	In-house Test method (Adapted from M926 Chloride analyzer Operation Manual)	mg/L
Nitrate *	7.5	25.5	34.5	Method 8171 (Adapted from HACH DR5000 Spectrophotometer procedure Manual)	mg/L
Phosphate *	<0.05 (LoQ 0.05 mg/L )	0.46	0.57	Method 8048 (Adapted from HACH DR5000 Spectrophotometer procedure Manual)	mg/L
Total Coliforms	1986	>2420	10	Colilert®-18/Quanti-Tray®2000	MPN/100ml

**Keys:** mg/L : Milligram Per Liter, MPN/100ml : Most Probable Number

Checked by



Aminath Sofa  
 Laboratory Executive

Approved by



Mohamed Eyman  
 Assistant Manager, Quality

**Notes: Sampling Authority:** Sampling was not done by MWSC Laboratory  
 This report shall not be reproduced except in full, without written approval of MWSC  
 This test report is ONLY FOR THE SAMPLES TESTED.  
 ~ Information provided by the customer  
 \*Parameters accredited by DAC under ISO / IEC 17025:2005



**WATER QUALITY TEST REPORT**  
 Report No: 500181970

**Customer Information:**  
 Water Solutions Pvt Ltd

Ionuziyaaraiy magu  
 Male' 20063

Report date: 09/04/2019  
 Test Requisition Form No: 900187119  
 Sample(s) Recieved Date: 03/04/2019  
 Date of Analysis: 03/04/2019 - 04/04/2019

Sample Description	Thilafushi GW7	Thilafushi GW8	TEST METHOD	UNIT		
Sample Type	Ground Water	Ground Water				
Sample No	83203947	83203948				
Sampled Date	02/04/2019	02/04/2019				
PARAMETER	ANALYSIS RESULT					
Physical Appearance	Yellow with particles	Cloudy and opaque				
Chloride	6125	1005	In-house Test method (Adapted from M926 Chloride analyzer Operation Manual)	mg/L		
Nitrate *	12.2	3.4	Method 8171 (Adapted from HACH DR5000 Spectrophotometer procedure Manual)	mg/L		
Phosphate *	2.27	0.72	Method 8048 (Adapted from HACH DR5000 Spectrophotometer procedure Manual)	mg/L		
Total Coliforms	>2420	4	Colilert®-18/Quanti-Tray®2000	MPN/100ml		

Keys: mg/L : Milligram Per Liter, MPN/100ml : Most Probable Number

Checked by

Aminath Sofa  
 Laboratory Executive

Approved by

Mohamed Eyman  
 Assistant Manager, Quality

**Notes: Sampling Authority:** Sampling was not done by MWSC Laboratory  
 This report shall not be reproduced except in full, without written approval of MWSC  
 This test report is ONLY FOR THE SAMPLES TESTED.  
 ~ Information provided by the customer  
 \*Parametres accredited by DAC under ISO / IEC 17025:2005

\*\*\*\*\* END OF REPORT \*\*\*\*\*

# TEST REPORT



**Report No:** (7418)144-0214A(SL)

Jul 14, 2018

Page 1 of 4

**Applicant:** Water Solutions (Pvt) Ltd.

**Address :** Ma Fas Eri, 1<sup>st</sup> Floor,  
Ameenee Magu,  
Male,  
Maldives.

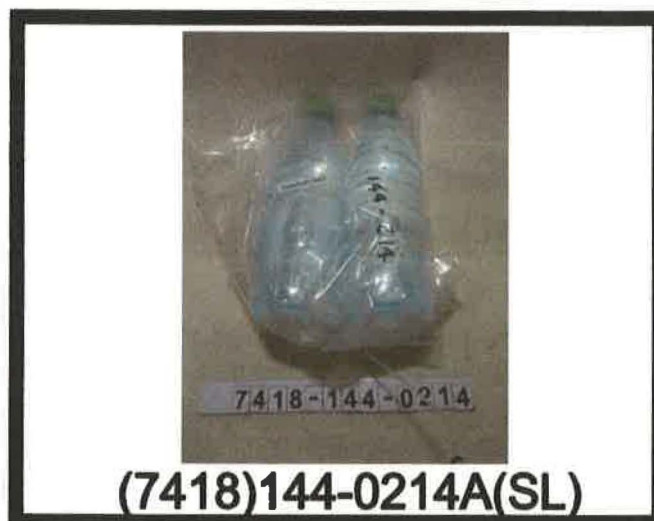
**Attn:** Mr. Aslam Mohamed/ Mr. Abdulla Fazeel

**Sample Received as:** 500ml x 2 No.s of water sample contained in sealed plastic bottles submitted by the client.

**Sample Described by the Client as:** Thilafushi SW1  
Date & time Sampled : 03/07/2018 at 07.30 a.m

**Date of Sample Received:** Jul 06, 2018  
**Date of Testing Started:** Jul 06, 2018  
**Date of Testing Completed:** Jul 13, 2018  
**Date of Report Issued:** Jul 14, 2018

**Photo of the Samples submitted**



**The content of this PDF file is in accordance with the original issued reports for reference only.  
This Test Report cannot be reproduced, except in full, without prior written permission of the company.**

## CPS CONDITIONS OF SERVICE

The party that submits a completed service request form to Company or signs a quotation issued by the Company for its performance of services ("Services") is the "Client" under these Conditions of Service. The entity within the Bureau Veritas Consumer Products Services division accepting the service request form and issuing the Report documenting the results of those Services is the "Company" under these Conditions of Service. Company and Client are, together, the "Parties" and each is a "Party". A request for Services constitutes a legally binding agreement on both Parties when such a request is accepted by the Company ("Agreement") under the following terms and conditions (collectively, "Conditions"):

**1. Services.** (a) The completion of the Services shall be evidenced by the Company's issuing to Client a written report setting forth the results of the Services based upon the properly accepted request, applicable protocols, written information, and where applicable, the product sample provided by Client to Company ("Report"). Company may delegate/assign the performance of all or a portion of the Services to an affiliate of Company or to an agent or subcontractor. Client shall provide to Company on a timely basis, all documents and information necessary to enable Company to properly perform the Services. Company may, in its sole discretion, dispose of product samples furnished to Company for the Services that were not destroyed in the course of performance of the Services. (b) Client represents and warrants to Company that (i) each product sample is not submitted in violation of a third party's intellectual property rights; (ii) Client will not use and rely upon Company's Report for any product whose properties differ from the sample(s) upon which the Report is based; and (iii) any goods subject to inspection will be completely prepared for the type of inspection booked for the specified date, and (c) Client accepts sole responsibility and liability for the accuracy of documents submitted to government or other regulatory bodies, including certificates of compliance required under the US Consumer Product Safety Improvement Act and EU requirements under REACH regulations. Client's responsibility and liability for accuracy shall apply even where Company has provided assistance to Client in preparation of such documentation.

**2. Report.** (a) The Report shall (i) constitute the sole deliverable for the Services, (ii) relate solely to the facts and circumstances as observed and recorded by Company at the time of performance of the Services within the limits of written information and instructions received from Client; Company shall have no obligation to update the Report after its issuance. Where the Services include testing or inspection: (i) the Report will set forth the findings of Company solely with respect to the product samples identified therein and (ii) the results set forth in the Report are not to be construed as indicative or representative of the quality or characteristics of the lot from which a product sample was taken for Company's performance of Services. (b) The Report is issued solely by Company, is intended for the exclusive use of Client and its affiliates and, except as required by a regulatory body, shall not be published, used for advertising purposes, copied or replicated for distribution or publicly disclosed without Company's prior written consent. Company is not responsible for any third party's interpretation of the Report. (c) Client shall not request a Report for purposes of litigation, nor shall it list Company, its affiliates or employees as an expert in any proceeding without Company's prior written consent. If Client anticipates producing or otherwise using the Report in any legal proceedings, it shall so notify Company prior to submitting the Report in such proceeding.

**3. Representations and Warranties.** (a) Company undertakes due care and ordinary skill in the performance of its Services. (b) Client agrees that Company is neither an insurer nor a guarantor and does not take the place of Client or the third parties that it retains, including designers, manufacturers, agents, buyers, distributors, and transportation or shipping companies; Company disclaims all liability in such capacities. Client understands that, if it seeks to protect itself from claims of loss, damage or injury, it should obtain appropriate insurance. (c) Company does not warrant or guarantee Client's products, and Company's Report does not represent a warranty of merchantability, a warranty of fitness for a particular purpose, or any other warranty or guarantee.

**4. Payment.** Payment in full shall be due 30 days after the date of invoice, failing which Company may revoke any credit extended to Client. Client shall reimburse Company for (i) interest on overdue amounts from the due date until paid at an interest rate of 1.5% per month and (ii) any other costs Company incurs in collecting past due amounts, including court, attorneys and collection agencies' fees.

**5. Intellectual Property.** The names, service marks, trademarks and copyrights of Company and its affiliates (collectively, the "Marks") are and remain the sole property of Company and shall not be used by Client. Client shall not contest the validity of the Marks or take any action that might impair the value or goodwill associated with the Marks or the image or reputation of Company or its affiliates. Client understands that any information or samples submitted to Company is a license for Company to use the same in the performance of Services.

**6. Relationship.** (a) Nothing herein creates a partnership, agency or joint venture between the Parties. (b) The failure to require strict observance or performance of any provision of these Conditions shall not be construed to be a waiver of a Party's right to later require strict observance and performance of the same. If any provision of these Conditions is held to be invalid or unenforceable, such invalidity shall not invalidate the remainder of the Conditions. (c) For a period of two years after the commencement of this Agreement, Client shall not directly or indirectly try to solicit for employment any of Company's employees.

**7. INDEMNITY.** CLIENT SHALL HOLD HARMLESS AND INDEMNIFY COMPANY, ITS AFFILIATES, AND THEIR RESPECTIVE DIRECTORS, OFFICERS, EMPLOYEES, AGENTS AND SUBCONTRACTORS AGAINST ALL THIRD-PARTY CLAIMS FOR LOSS, DAMAGE, INJURY, DEATH, OR EXPENSE OF WHATEVER NATURE, INCLUDING BUT NOT LIMITED TO CLAIMS ARISING FROM OR RELATING TO (I) THE PERFORMANCE OF ANY SERVICES BY COMPANY, (II) THE SALE, RESALE, MANUFACTURE, DISTRIBUTION OR USE OF ANY OF CLIENT'S GOODS OR (III) BREACH OF CLIENT'S OBLIGATIONS OR WARRANTIES HEREIN.

**8. LIMITATIONS OF LIABILITY.** (A) COMPANY SHALL NOT BE LIABLE FOR ANY INDIRECT, CONSEQUENTIAL OR SPECIAL LOSS IN CONNECTION WITH THE REPORT, THE PRODUCT FOR WHICH SERVICES WERE PERFORMED, OR THE SERVICES PROVIDED BY COMPANY HEREUNDER. COMPANY SHALL NOT BE LIABLE FOR ANY LOSS OR DAMAGE WHATSOEVER RESULTING FROM ANY DELAY IN THE PERFORMANCE OF ITS OBLIGATIONS HEREUNDER OR FROM THE FAILURE OF COMPANY TO PROVIDE ITS SERVICES WITHIN ANY TIME PERIOD FOR COMPLETION ESTIMATED BY COMPANY, REGARDLESS OF THE CAUSE OF THE DELAY OR FAILURE. (B) THE ENTIRE FINANCIAL AND LEGAL LIABILITY OF COMPANY IN RESPECT OF ANY CLAIM FOR LOSS, INDEMNITY, CONTRIBUTION OR DAMAGE OF WHATEVER NATURE OR HOWSOEVER ARISING, SHALL NOT EXCEED AN AMOUNT EQUAL TO FIVE (5) TIMES THE AMOUNT OF FEES PAID TO COMPANY FOR THE SPECIFIC SERVICES WHICH GAVE RISE TO SUCH CLAIM.

**9. Force Majeure.** If any event of force majeure or any event outside the control of Company occurs, Company may immediately cancel or suspend its performance hereunder without incurring any liability whatsoever to Client.

**10. Governing Law.** These Conditions shall be governed by the laws of the country as follows: for Services performed in (i) the Americas: the laws of New York, (ii) Asia Pacific, South Asia, Middle East and Africa: the laws of Hong Kong (except for China where PRC laws govern), and (iii) Europe: the laws of England.

**11. Dispute Resolution.** (a) If Client desires to assert a claim relating to the Services, it must submit the same to Company in writing setting forth with particularity the basis for such claim within 90 days from discovery of the claim and not more than six months after the date of issuance of the Report. Client waives any and all claims without limitation that it does not submit within such time periods. (b) If a dispute arises under this Agreement, the Parties shall first attempt good faith negotiations, failing which, the Parties (i) agree that the courts of the country of governing law shall have exclusive jurisdiction to settle any such dispute related to this Agreement and (ii) irrevocably waive their right to trial by jury in any such action or proceeding.

**12.** These Conditions, the applicable order form and/or quotation and the Report represent the entire understanding of the Parties on the subject matter hereof, and no modification is binding unless in writing. Any of Client's terms and conditions attached to, enclosed with or referred to in any order form, purchase order or other document shall not apply.



# TEST REPORT

Report No:

(7418)144-0214A(SL)

Jul 14, 2018

Page 2 of 4

## TEST RESULTS

No.	Parameters	Results	LOQ	Unit	Test Method
1	Temperature at Receiving	24.2	-	°C	APHA 20th Edition – 2550B
2	Turbidity	0.3	-	NTU	APHA 2130 B
3	pH at 24°C*	8.4	-	-	FD-MTHD-007:2013 Reference to APHA 4500H+
4	Nitrate (as NO <sub>3</sub> <sup>-</sup> )	0.3	-	mg/l	APHA 4500 -NO <sub>3</sub> - E
5	Oil & Grease*	<2.0	2.0	mg/l	FD-MTHD-032:2013 Reference to APHA 5520B
6	Free Ammonia (as NH <sub>3</sub> )	0.05	-	mg/l	SLS 614 Appendix A: 2013
7	Salinity	36	-	ppt	APHA 2520
<b>Heavy Metals</b>					
8	Arsenic (as As)*	ND	0.001	mg/l	CPSD-AN-00581-MTHD with ICP-MS
9	Cadmium (as Cd)*	ND	0.0001	mg/l	
10	Lead (as Pb)*	ND	0.001	mg/l	
11	Mercury (as Hg)*	ND	0.00005	mg/l	
12	Nickel (as Ni)*	ND	0.001	mg/l	
13	Copper (as Cu)*	ND	0.001	mg/l	
14	Zinc (as Zn)*	ND	0.001	mg/l	
15	Chromium (as Cr)	ND	0.001	mg/l	



**BUREAU  
VERITAS**

# TEST REPORT

Report No:

(7418)144-0214A(SL)

Jul 14, 2018

Page 3 of 4

**Remark –**

**\*ISO 17025 :2005 ACCREDITED TEST BY SRI LANKA ACCREDITATION BOARD FOR CONFORMITY ASSESSMENT (SLAB)**

**NOTE:**

mg/l: milligrams per liter, ppt: parts per thousand,  
APHA: American Public Health Association  
ND: Not Detected, LOQ: Limit of Quantification,  
NTU: Nephelometric Turbidity Units, °C : Celcius,  
ICP-MS: Inductively Coupled Plasma – Mass Spectroscopy.

**Contact information for this report (Technical and General Inquiries and Feedback)**

<b>GENERAL INQUIRIES:</b>		
IROSHA UDUGAMPALA	TEL: +94 768 229 528	E-MAIL: Irosha.Udugampala@lk.bureauveritas.com
<b>TECHNICAL INQUIRIES:</b>		
INDRAJITH HATHURUSINGHA	TEL: + 94 769 603 814	E-MAIL: Indrajith.hs@lk.bureauveritas.com
<b>FEED BACK:</b>		
DHANUKA PERERA –EXECUTIVE QHSE	TEL: +94 768 229 479	E-MAIL: dhanuka.perera@lk.bureauveritas.com

REVIEWED BY: SHYAMIKA WICKRAMASINGHE

BUREAU VERITAS CONSUMER PRODUCTS SERVICES LANKA (PVT) LTD.

AUTHORIZED SIGNATORY

APPROVED BY:

INDRAJITH HATHURUSINGHA  
MANAGER -  
FOOD LABORATORY





# TEST REPORT

Report No:

(7418)144-0214A(SL)

Jul 14, 2018

Page 4 of 4

## CPS CONDITIONS OF SERVICE

The party that submits a completed service request form to Company or signs a quotation issued by the Company for its performance of services ("Services") is the "Client" under these Conditions of Service. The entity within the Bureau Veritas Consumer Products Services division accepting the service request form and issuing the Report documenting the results of those Services is the "Company" under these Conditions of Service. Company and Client are, together, the "Parties" and each is a "Party". A request for Services constitutes a legally binding agreement on both Parties when such a request is accepted by the Company ("Agreement") under the following terms and conditions (collectively, "Conditions"):

1. **Services.** (a) The completion of the Services shall be evidenced by the Company's issuing to Client a written report setting forth the results of the Services based upon the properly accepted request, applicable protocols, written information, and where applicable, the product sample provided by Client to Company ("Report"). Company may delegate/assign the performance of all or a portion of the Services to an affiliate of Company or to an agent or subcontractor. Client shall provide to Company on a timely basis all documents and information necessary to enable Company to properly perform the Services. Company may, in its sole discretion, dispose of product samples furnished to Company for the Services that were not destroyed in the course of performance of the Services. (b) Client represents and warrants to Company that (i) each product sample is not submitted in violation of a third party's intellectual property rights, (ii) Client will not use and rely upon Company's Report for any product whose properties differ from the sample(s) upon which the Report is based; and (iii) any goods subject to inspection will be completely prepared for the type of inspection booked for the specified date, and (c) Client accepts sole responsibility and liability for the accuracy of documents submitted to government or other regulatory bodies, including certificates of compliance required under the US Consumer Product Safety Improvement Act and EU requirements under REACH regulations. Client's responsibility and liability for accuracy shall apply even where Company has provided assistance to Client in preparation of such documentation.
2. **Report.** (a) The Report shall (i) constitute the sole deliverable for the Services, (ii) relate solely to the facts and circumstances as observed and recorded by Company at the time of performance of the Services within the limits of written information and instructions received from Client. Company shall have no obligation to update the Report after its issuance. Where the Services include testing or inspection (i) the Report will set forth the findings of Company solely with respect to the product samples identified therein and (ii) the results set forth in the Report are not to be construed as indicative or representative of the quality or characteristics of the lot from which a product sample was taken for Company's performance of Services. (b) The Report is issued solely by Company, is intended for the exclusive use of Client and its affiliates and, except as required by a regulatory body, shall not be published, used for advertising purposes, copied or replicated for distribution or publicly disclosed without Company's prior written consent. Company is not responsible for any third party's interpretation of the Report. (c) Client shall not request a Report for purposes of litigation, nor shall it list Company, its affiliates or employees as an expert in any proceeding without Company's prior written consent. If Client anticipates producing or otherwise using the Report in any legal proceedings, it shall so notify Company prior to submitting the Report in such proceeding.
3. **Representations and Warranties.** (a) Company undertakes due care and ordinary skill in the performance of its Services. (b) Client agrees that Company is neither an insurer nor a guarantor and does not take the place of Client or the third parties that it retains, including designers, manufacturers, agents, buyers, distributors, and transportation or shipping companies. Company disclaims all liability in such capacities. Client understands that, if it seeks to protect itself from claims of loss, damage or injury, it should obtain appropriate insurance. (c) Company does not warrant or guarantee Client's products, and Company's Report does not represent a warranty of merchantability, a warranty of fitness for a particular purpose, or any other warranty or guarantee.
4. **Payment.** Payment in full shall be due 30 days after the date of invoice, failing which Company may revoke any credit extended to Client. Client shall reimburse Company for (i) interest on overdue amounts from the due date until paid at an interest rate of 1.5% per month and (ii) any other costs Company incurs in collecting past due amounts, including court, attorneys and collection agencies' fees.
5. **Intellectual Property.** The names, service marks, trademarks and copyrights of Company and its affiliates (collectively the "Marks") are and remain the sole property of Company and shall not be used by Client. Client shall not contest the validity of the Marks or take any action that might impair the value or goodwill associated with the Marks or the image or reputation of Company or its affiliates. Client understands that any information or samples submitted to Company is a license for Company to use the same in the performance of Services.
6. **Relationship.** (a) Nothing herein creates a partnership, agency or joint venture between the Parties. (b) The failure to require strict observance or performance of any provision of these Conditions shall not be construed to be a waiver of a Party's right to later require strict observance and performance of the same. If any provision of these Conditions is held to be invalid or unenforceable, such invalidity shall not invalidate the remainder of the Conditions. (c) For a period of two years after the commencement of this Agreement, Client shall not directly or indirectly try to solicit for employment any of Company's employees.
7. **INDEMNITY.** CLIENT SHALL HOLD HARMLESS AND INDEMNIFY COMPANY, ITS AFFILIATES, AND THEIR RESPECTIVE DIRECTORS, OFFICERS, EMPLOYEES, AGENTS AND SUBCONTRACTORS AGAINST ALL THIRD-PARTY CLAIMS FOR LOSS, DAMAGE, INJURY, DEATH OR EXPENSE OF WHATEVER NATURE, INCLUDING BUT NOT LIMITED TO CLAIMS ARISING FROM OR RELATING TO (I) THE PERFORMANCE OF ANY SERVICES BY COMPANY, (II) THE SALE, RESALE, MANUFACTURE, DISTRIBUTION OR USE OF ANY OF CLIENT'S GOODS OR (III) BREACH OF CLIENT'S OBLIGATIONS OR WARRANTIES HEREIN.
8. **LIMITATIONS OF LIABILITY.** (A) COMPANY SHALL NOT BE LIABLE FOR ANY INDIRECT, CONSEQUENTIAL OR SPECIAL LOSS IN CONNECTION WITH THE REPORT, THE PRODUCT FOR WHICH SERVICES WERE PERFORMED, OR THE SERVICES PROVIDED BY COMPANY HEREUNDER. COMPANY SHALL NOT BE LIABLE FOR ANY LOSS OR DAMAGE WHATSOEVER RESULTING FROM ANY DELAY IN THE PERFORMANCE OF ITS OBLIGATIONS HEREUNDER OR FROM THE FAILURE OF COMPANY TO PROVIDE ITS SERVICES WITHIN ANY TIME PERIOD FOR COMPLETION ESTIMATED BY COMPANY, REGARDLESS OF THE CAUSE OF THE DELAY OR FAILURE. (B) THE ENTIRE FINANCIAL AND LEGAL LIABILITY OF COMPANY IN RESPECT OF ANY CLAIM FOR LOSS, INDEMNITY, CONTRIBUTION OR DAMAGE OF WHATEVER NATURE OR HOWSOEVER ARISING, SHALL NOT EXCEED AN AMOUNT EQUAL TO FIVE (5) TIMES THE AMOUNT OF FEES PAID TO COMPANY FOR THE SPECIFIC SERVICES WHICH GAVE RISE TO SUCH CLAIM.
9. **Force Majeure.** If any event of force majeure or any event outside the control of Company occurs, Company may immediately cancel or suspend its performance hereunder without incurring any liability whatsoever to Client.
10. **Governing Law.** These Conditions shall be governed by the laws of the country as follows: for Services performed in (i) the Americas: the laws of New York; (ii) Asia Pacific, South Asia, Middle East and Africa: the laws of Hong Kong (except for China where PRC laws govern), and (iii) Europe: the laws of England.
11. **Dispute Resolution.** (a) If Client desires to assert a claim relating to the Services, it must submit the same to Company in writing setting forth with particularity the basis for such claim within 90 days from discovery of the claim and not more than six months after the date of issuance of the Report. Client waives any and all claims without limitation that it does not submit within such time periods. (b) If a dispute arises under this Agreement, the Parties shall first attempt good faith negotiations, failing which, the Parties (i) agree that the courts of the country of governing law shall have exclusive jurisdiction to settle any such dispute related to this Agreement and (ii) irrevocably waive their right to trial by jury in any such action or proceeding.
12. These Conditions, the applicable order form and/or quotation and the Report represent the entire understanding of the Parties on the subject matter hereof, and no modification is binding unless in writing. Any of Client's terms and conditions attached to, enclosed with or referred to in any order form, purchase order or other document shall not apply.

Gen v 1 copyright 2015 Bureau Veritas

END OF THE REPORT.

**Report No:**

**(7418)144-0214B(SL)**

**Jul 14, 2018**

**Page 1 of 4**

**Applicant:** Water Solutions (Pvt) Ltd.

**Address :** Ma Fas Eri, 1<sup>st</sup> Floor,  
Ameenee Magu,  
Male,  
Maldives.

**Attn:** Mr. Aslam Mohamed/ Mr. Abdulla Fazeel

**Sample Received as:** 500ml x 2 No.s of water sample contained in sealed plastic bottles submitted by the client.

**Sample Described by the Client as:** Thilafushi SW2  
Date & time Sampled : 03/07/2018 at 07.45 a.m

**Date of Sample Received:** Jul 06, 2018

**Date of Testing Started:** Jul 06, 2018

**Date of Testing Completed:** Jul 13, 2018

**Date of Report Issued:** Jul 14, 2018

**Photo of the Submitted Sample**



**The content of this PDF file is in accordance with the original issued reports for reference only.  
This Test Report cannot be reproduced, except in full, without prior written permission of the company.**

## CPS CONDITIONS OF SERVICE

The party that submits a completed service request form to Company or signs a quotation issued by the Company for its performance of services ("Services") is the "Client" under these Conditions of Service. The entity within the Bureau Veritas Consumer Products Services division accepting the service request form and issuing the Report documenting the results of those Services is the "Company" under these Conditions of Service. Company and Client are, together, the "Parties" and each is a "Party". A request for Services constitutes a legally binding agreement on both Parties when such a request is accepted by the Company ("Agreement") under the following terms and conditions (collectively, "Conditions"):

- 1. Services.** (a) The completion of the Services shall be evidenced by the Company's issuing to Client a written report setting forth the results of the Services based upon the properly accepted request, applicable protocols, written information, and where applicable, the product sample provided by Client to Company ("Report"). Company may delegate/assign the performance of all or a portion of the Services to an affiliate of Company or to an agent or subcontractor. Client shall provide to Company on a timely basis, all documents and information necessary to enable Company to properly perform the Services. Company may, in its sole discretion, dispose of product samples furnished to Company for the Services that were not destroyed in the course of performance of the Services. (b) Client represents and warrants to Company that (i) each product sample is not submitted in violation of a third party's intellectual property rights; (ii) Client will not use and rely upon Company's Report for any product whose properties differ from the sample(s) upon which the Report is based; and (iii) any goods subject to inspection will be completely prepared for the type of inspection booked for the specified date, and (c) Client accepts sole responsibility and liability for the accuracy of documents submitted to government or other regulatory bodies, including certificates of compliance required under the US Consumer Product Safety Improvement Act and EU requirements under REACH regulations. Client's responsibility and liability for accuracy shall apply even where Company has provided assistance to Client in preparation of such documentation.
- 2. Report.** (a) The Report shall (i) constitute the sole deliverable for the Services, (ii) relate solely to the facts and circumstances as observed and recorded by Company at the time of performance of the Services within the limits of written information and instructions received from Client; Company shall have no obligation to update the Report after its issuance. Where the Services include testing or inspection: (i) the Report will set forth the findings of Company solely with respect to the product samples identified therein and (ii) the results set forth in the Report are not to be construed as indicative or representative of the quality or characteristics of the lot from which a product sample was taken for Company's performance of Services. (b) The Report is issued solely by Company, is intended for the exclusive use of Client and its affiliates and, except as required by a regulatory body, shall not be published, used for advertising purposes, copied or replicated for distribution or publicly disclosed without Company's prior written consent. Company is not responsible for any third party's interpretation of the Report. (c) Client shall not request a Report for purposes of litigation, nor shall it list Company, its affiliates or employees as an expert in any proceeding without Company's prior written consent. If Client anticipates producing or otherwise using the Report in any legal proceedings, it shall so notify Company prior to submitting the Report in such proceeding.
- 3. Representations and Warranties.** (a) Company undertakes due care and ordinary skill in the performance of its Services. (b) Client agrees that Company is neither an insurer nor a guarantor and does not take the place of Client or the third parties that it retains, including designers, manufacturers, agents, buyers, distributors, and transportation or shipping companies; Company disclaims all liability in such capacities. Client understands that, if it seeks to protect itself from claims of loss, damage or injury, it should obtain appropriate insurance. (c) Company does not warrant or guarantee Client's products, and Company's Report does not represent a warranty of merchantability, a warranty of fitness for a particular purpose, or any other warranty or guarantee.
- 4. Payment.** Payment in full shall be due 30 days after the date of invoice, failing which Company may revoke any credit extended to Client. Client shall reimburse Company for (i) interest on overdue amounts from the due date until paid at an interest rate of 1.5% per month and (ii) any other costs Company incurs in collecting past due amounts, including court, attorneys and collection agencies' fees.
- 5. Intellectual Property.** The names, service marks, trademarks and copyrights of Company and its affiliates (collectively, the "Marks") are and remain the sole property of Company and shall not be used by Client. Client shall not contest the validity of the Marks or take any action that might impair the value or goodwill associated with the Marks or the image or reputation of Company or its affiliates. Client understands that any information or samples submitted to Company is a license for Company to use the same in the performance of Services.
- 6. Relationship.** (a) Nothing herein creates a partnership, agency or joint venture between the Parties. (b) The failure to require strict observance or performance of any provision of these Conditions shall not be construed to be a waiver of a Party's right to later require strict observance and performance of the same. If any provision of these Conditions is held to be invalid or unenforceable, such invalidity shall not invalidate the remainder of the Conditions. (c) For a period of two years after the commencement of this Agreement, Client shall not directly or indirectly try to solicit for employment any of Company's employees.
- 7. INDEMNITY.** CLIENT SHALL HOLD HARMLESS AND INDEMNIFY COMPANY, ITS AFFILIATES, AND THEIR RESPECTIVE DIRECTORS, OFFICERS, EMPLOYEES, AGENTS AND SUBCONTRACTORS AGAINST ALL THIRD-PARTY CLAIMS FOR LOSS, DAMAGE, INJURY, DEATH, OR EXPENSE OF WHATEVER NATURE, INCLUDING BUT NOT LIMITED TO CLAIMS ARISING FROM OR RELATING TO (I) THE PERFORMANCE OF ANY SERVICES BY COMPANY, (II) THE SALE, RESALE, MANUFACTURE, DISTRIBUTION OR USE OF ANY OF CLIENT'S GOODS OR (III) BREACH OF CLIENT'S OBLIGATIONS OR WARRANTIES HEREIN.
- 8. LIMITATIONS OF LIABILITY.** (A) COMPANY SHALL NOT BE LIABLE FOR ANY INDIRECT, CONSEQUENTIAL OR SPECIAL LOSS IN CONNECTION WITH THE REPORT, THE PRODUCT FOR WHICH SERVICES WERE PERFORMED, OR THE SERVICES PROVIDED BY COMPANY HEREUNDER. COMPANY SHALL NOT BE LIABLE FOR ANY LOSS OR DAMAGE WHATSOEVER RESULTING FROM ANY DELAY IN THE PERFORMANCE OF ITS OBLIGATIONS HEREUNDER OR FROM THE FAILURE OF COMPANY TO PROVIDE ITS SERVICES WITHIN ANY TIME PERIOD FOR COMPLETION ESTIMATED BY COMPANY, REGARDLESS OF THE CAUSE OF THE DELAY OR FAILURE. (B) THE ENTIRE FINANCIAL AND LEGAL LIABILITY OF COMPANY IN RESPECT OF ANY CLAIM FOR LOSS, INDEMNITY, CONTRIBUTION OR DAMAGE OF WHATEVER NATURE OR HOWSOEVER ARISING, SHALL NOT EXCEED AN AMOUNT EQUAL TO FIVE (5) TIMES THE AMOUNT OF FEES PAID TO COMPANY FOR THE SPECIFIC SERVICES WHICH GAVE RISE TO SUCH CLAIM.
- 9. Force Majeure.** If any event of force majeure or any event outside the control of Company occurs, Company may immediately cancel or suspend its performance hereunder without incurring any liability whatsoever to Client.
- 10. Governing Law.** These Conditions shall be governed by the laws of the country as follows: for Services performed in (i) the Americas: the laws of New York, (ii) Asia Pacific, South Asia, Middle East and Africa: the laws of Hong Kong (except for China where PRC laws govern), and (iii) Europe: the laws of England.
- 11. Dispute Resolution.** (a) If Client desires to assert a claim relating to the Services, it must submit the same to Company in writing setting forth with particularity the basis for such claim within 90 days from discovery of the claim and not more than six months after the date of issuance of the Report. Client waives any and all claims without limitation that it does not submit within such time periods. (b) If a dispute arises under this Agreement, the Parties shall first attempt good faith negotiations, failing which, the Parties (i) agree that the courts of the country of governing law shall have exclusive jurisdiction to settle any such dispute related to this Agreement and (ii) irrevocably waive their right to trial by jury in any such action or proceeding.
- 12.** These Conditions, the applicable order form and/or quotation and the Report represent the entire understanding of the Parties on the subject matter hereof, and no modification is binding unless in writing. Any of Client's terms and conditions attached to, enclosed with or referred to in any order form, purchase order or other document shall not apply.



# TEST REPORT

Report No:

(7418)144-0214B(SL)

Jul 14, 2018

Page 2 of 4

## TEST RESULTS

No.	Parameters	Results	LOQ	Unit	Test Method
1	Temperature at Receiving	24.2	-	°C	APHA 20th Edition – 2550B
2	Turbidity	0.2	-	NTU	APHA 2130 B
3	pH at 24°C*	8.4	-	-	FD-MTHD-007:2013 Reference to APHA 4500H+
4	Nitrate (as NO <sub>3</sub> <sup>-</sup> )	0.4	-	mg/l	APHA 4500 -NO <sub>3</sub> - E
5	Oil & Grease*	<2.0	2.0	mg/l	FD-MTHD-032:2013 Reference to APHA 5520B
6	Free Ammonia (as NH <sub>3</sub> )	<0.02	0.02	mg/l	SLS 614 Appendix A: 2013
7	Salinity	37	-	ppt	APHA 2520
<b>Heavy Metals</b>					
8	Arsenic (as As)*	ND	0.001	mg/l	CPSD-AN-00581-MTHD with ICP-MS
9	Cadmium (as Cd)*	ND	0.0001	mg/l	
10	Lead (as Pb)*	ND	0.001	mg/l	
11	Mercury (as Hg)*	ND	0.00005	mg/l	
12	Nickel (as Ni)*	ND	0.001	mg/l	
13	Copper (as Cu)*	ND	0.001	mg/l	
14	Zinc (as Zn)*	0.003	-	mg/l	
15	Chromium (as Cr)	ND	0.001	mg/l	



# TEST REPORT

Report No:

(7418)144-0214B(SL)

Jul 14, 2018

Page 3 of 4

**Remark –**

**\*ISO 17025 :2005 ACCREDITED TEST BY SRI LANKA ACCREDITATION BOARD FOR CONFORMITY ASSESSMENT (SLAB)**

**NOTE:**

mg/l: milligrams per liter, ppt: parts per thousand,  
APHA: American Public Health Association  
ND: Not Detected, LOQ: Limit of Quantification,  
NTU: Nephelometric Turbidity Units, °C : Celcius,  
ICP-MS: Inductively Coupled Plasma – Mass Spectroscopy.

**Contact information for this report (Technical and General Inquiries and Feedback)**

<b>GENERAL INQUIRIES:</b>		
IROSHA UDUGAMPALA	TEL: +94 768 229 528	E-MAIL: irosha.Udugampala@lk.bureauveritas.com
<b>TECHNICAL INQUIRIES:</b>		
INDRAJITH HATHURUSINGHA	TEL: + 94 769 603 814	E-MAIL: Indrajith.hs@lk.bureauveritas.com
<b>FEED BACK:</b>		
DHANUKA PERERA –EXECUTIVE QHSE	TEL: +94 768 229 479	E-MAIL: dhanuka.perera@lk.bureauveritas.com

REVIEWED BY: SHYAMIKA WICKRAMASINGHE

BUREAU VERITAS CONSUMER PRODUCTS SERVICES LANKA (PVT) LTD.

AUTHORIZED SIGNATORY

APPROVED BY:

INDRAJITH HATHURUSINGHA  
MANAGER -  
FOOD LABORATORY



# TEST REPORT

Report No:

(7418)144-0214B(SL)

Jul 14, 2018

Page 4 of 4

## CPS CONDITIONS OF SERVICE

The party that submits a completed service request form to Company or signs a quotation issued by the Company for its performance of services ("Services") is the "Client" under these Conditions of Service. The entity within the Bureau Veritas Consumer Products Services division accepting the service request form and issuing the Report documenting the results of those Services is the "Company" under these Conditions of Service. Company and Client are, together, the "Parties" and each is a "Party". A request for Services constitutes a legally binding agreement on both Parties when such a request is accepted by the Company ("Agreement") under the following terms and conditions (collectively, "Conditions").

**1. Services.** (a) The completion of the Services shall be evidenced by the Company's issuing to Client a written report setting forth the results of the Services, based upon the properly accepted request, applicable protocols, written information, and where applicable, the product sample provided by Client to Company ("Report"). Company may delegate/assign the performance of all or a portion of the Services to an affiliate of Company or to an agent or subcontractor. Client shall provide to Company on a timely basis, all documents and information necessary to enable Company to properly perform the Services. Company may, in its sole discretion, dispose of product samples furnished to Company for the Services that were not destroyed in the course of performance of the Services. (b) Client represents and warrants to Company that (i) each product sample is not submitted in violation of a third party's intellectual property rights, (ii) Client will not use and rely upon Company's Report for any product whose properties differ from the sample(s) upon which the Report is based; and (iii) any goods subject to inspection will be completely prepared for the type of inspection booked for the specified date, and (c) Client accepts sole responsibility and liability for the accuracy of documents submitted to government or other regulatory bodies, including certificates of compliance required under the US Consumer Product Safety Improvement Act and EU requirements under REACH regulations. Client's responsibility and liability for accuracy shall apply even where Company has provided assistance to Client in preparation of such documentation.

**2. Report.** (a) The Report shall (i) constitute the sole deliverable for the Services, (ii) relate solely to the facts and circumstances as observed and recorded by Company at the time of performance of the Services within the limits of written information and instructions received from Client; Company shall have no obligation to update the Report after its issuance. Where the Services include testing or inspection (i) the Report will set forth the findings of Company solely with respect to the product samples identified therein and (ii) the results set forth in the Report are not to be construed as indicative or representative of the quality or characteristics of the lot from which a product sample was taken for Company's performance of Services. (b) The Report is issued solely by Company, is intended for the exclusive use of Client and its affiliates, and, except as required by a regulatory body, shall not be published, used for advertising purposes, copied or replicated for distribution or publicly disclosed without Company's prior written consent. Company is not responsible for any third party's interpretation of the Report. (c) Client shall not request a Report for purposes of litigation, nor shall it list Company, its affiliates or employees as an expert in any proceeding without Company's prior written consent. If Client anticipates producing or otherwise using the Report in any legal proceedings, it shall so notify Company prior to submitting the Report in such proceeding.

**3. Representations and Warranties.** (a) Company undertakes due care and ordinary skill in the performance of its Services. (b) Client agrees that Company is neither an insurer nor a guarantor and does not take the place of Client or the third parties that it retains, including designers, manufacturers, agents, buyers, distributors, and transportation or shipping companies. Company disclaims all liability in such capacities. Client understands that if it seeks to protect itself from claims of loss, damage or injury, it should obtain appropriate insurance. (c) Company does not warrant or guarantee Client's products, and Company's Report does not represent a warranty of merchantability, a warranty of fitness for a particular purpose, or any other warranty or guarantee.

**4. Payment.** Payment in full shall be due 30 days after the date of invoice, failing which Company may revoke any credit extended to Client. Client shall reimburse Company for (i) interest on overdue amounts from the due date until paid at an interest rate of 1.5% per month and (ii) any other costs Company incurs in collecting past due amounts, including court, attorneys and collection agencies' fees.

**5. Intellectual Property.** The names, service marks, trademarks and copyrights of Company and its affiliates (collectively, the "Marks") are and remain the sole property of Company and shall not be used by Client. Client shall not contest the validity of the Marks or take any action that might impair the value or goodwill associated with the Marks or the image or reputation of Company or its affiliates. Client understands that any information or samples submitted to Company is a license for Company to use the same in the performance of Services.

**6. Relationship.** (a) Nothing herein creates a partnership, agency or joint venture between the Parties. (b) The failure to require strict observance or performance of any provision of these Conditions shall not be construed to be a waiver of a Party's right to later require strict observance and performance of the same. If any provision of these Conditions is held to be invalid or unenforceable, such invalidity shall not invalidate the remainder of the Conditions. (c) For a period of two years after the commencement of this Agreement, Client shall not directly or indirectly try to solicit for employment any of Company's employees.

**7. INDEMNITY.** CLIENT SHALL HOLD HARMLESS AND INDEMNIFY COMPANY, ITS AFFILIATES, AND THEIR RESPECTIVE DIRECTORS, OFFICERS, EMPLOYEES, AGENTS AND SUBCONTRACTORS AGAINST ALL THIRD-PARTY CLAIMS FOR LOSS, DAMAGE, INJURY, DEATH, OR EXPENSE OF WHATEVER NATURE, INCLUDING BUT NOT LIMITED TO CLAIMS ARISING FROM OR RELATING TO (i) THE PERFORMANCE OF ANY SERVICES BY COMPANY, (ii) THE SALE, RESALE, MANUFACTURE, DISTRIBUTION OR USE OF ANY OF CLIENT'S GOODS OR (iii) BREACH OF CLIENT'S OBLIGATIONS OR WARRANTIES HEREIN.

**8. LIMITATIONS OF LIABILITY.** (A) COMPANY SHALL NOT BE LIABLE FOR ANY INDIRECT, CONSEQUENTIAL OR SPECIAL LOSS IN CONNECTION WITH THE REPORT, THE PRODUCT FOR WHICH SERVICES WERE PERFORMED OR THE SERVICES PROVIDED BY COMPANY HEREUNDER. COMPANY SHALL NOT BE LIABLE FOR ANY LOSS OR DAMAGE WHATSOEVER RESULTING FROM ANY DELAY IN THE PERFORMANCE OF ITS OBLIGATIONS HEREUNDER OR FROM THE FAILURE OF COMPANY TO PROVIDE ITS SERVICES WITHIN ANY TIME PERIOD FOR COMPLETION ESTIMATED BY COMPANY, REGARDLESS OF THE CAUSE OF THE DELAY OR FAILURE. (B) THE ENTIRE FINANCIAL AND LEGAL LIABILITY OF COMPANY IN RESPECT OF ANY CLAIM FOR LOSS, INDEMNITY, CONTRIBUTION OR DAMAGE OF WHATEVER NATURE OR HOWSOEVER ARISING, SHALL NOT EXCEED AN AMOUNT EQUAL TO FIVE (5) TIMES THE AMOUNT OF FEES PAID TO COMPANY FOR THE SPECIFIC SERVICES WHICH GAVE RISE TO SUCH CLAIM.

**9. Force Majeure.** If any event of force majeure or any event outside the control of Company occurs, Company may immediately cancel or suspend its performance hereunder without incurring any liability whatsoever to Client.

**10. Governing Law.** These Conditions shall be governed by the laws of the country as follows: for Services performed in (i) the Americas, the laws of New York; (ii) Asia Pacific, South Asia, Middle East and Africa, the laws of Hong Kong (except for China where PRC laws govern); and (iii) Europe, the laws of England.

**11. Dispute Resolution.** (a) If Client desires to assert a claim relating to the Services, it must submit the same to Company in writing setting forth with particularity the basis for such claim within 90 days from discovery of the claim and not more than six months after the date of issuance of the Report. Client waives any and all claims without limitation that it does not submit within such time periods. (b) If a dispute arises under this Agreement, the Parties shall first attempt good faith negotiations, failing which, the Parties (i) agree that the courts of the country of governing law shall have exclusive jurisdiction to settle any such dispute related to this Agreement and (ii) irrevocably waive their right to trial by jury in any such action or proceeding.

**12. These Conditions, the applicable order form and/or quotation and the Report represent the entire understanding of the Parties on the subject matter hereof, and no modification is binding unless in writing. Any of Client's terms and conditions attached to, enclosed with or referred to in any order form, purchase order or other document shall not apply.**

Gen v 1 copyright 2015 Bureau Veritas

END OF THE REPORT.

**Report No:**

**(7418)144-0214C(SL)**

**Jul 14, 2018**

**Page 1 of 4**

**Applicant:** Water Solutions (Pvt) Ltd.

**Address :** Ma Fas Eri, 1<sup>st</sup> Floor,  
Ameenee Magu,  
Male,  
Maldives.

**Attn:** Mr. Aslam Mohamed/ Mr. Abdulla Fazeel

**Sample Received as:** 500ml x 2 No.s of water sample contained in sealed plastic bottles submitted by the client.

**Sample Described by the Client as:** Thilafushi SW3  
Date & time Sampled : 03/07/2018 at 08.00 a.m

**Date of Sample Received:** Jul 06, 2018

**Date of Testing Started:** Jul 06, 2018

**Date of Testing Completed:** Jul 13, 2018

**Date of Report Issued:** Jul 14, 2018

**Photo of the Submitted Sample**



**The content of this PDF file is in accordance with the original issued reports for reference only.  
This Test Report cannot be reproduced, except in full, without prior written permission of the company.**

**Bureau Veritas Consumer Products Services Lanka (Pvt) Ltd.**

No. 570, Galle Road, Katubedda, Sri Lanka.

Tel : (9411) 2350111 Fax : (9411) 2622198 / 9

E-mail : [bvcp.lanka@lk.bureauveritas.com](mailto:bvcp.lanka@lk.bureauveritas.com)

This report is governed by, and incorporates by reference, the Conditions of Testing as posted at the date of issuance of this report at <http://www.mil-acts.com> and is intended for your exclusive use. Any copying or replication of this report to or for any other person or entity, or use of our name or trademark, is permitted only with our prior written permission. This report sets forth our findings solely with respect to the test samples identified herein. The results set forth in this report are not indicative or representative of the quality or characteristics of the lot from which a test sample was taken or any similar or identical product unless specifically and expressly noted. Our report includes all of the tests requested by you and the results thereof based upon the information that you provided to us. You have 90 days from date of issuance of this report to notify us of any material error or omission caused by our negligence, provided, however, that such notice shall be in writing and shall specifically address the issue you wish to raise. A failure to raise such issue within the prescribed time shall constitute your unqualified acceptance of the completeness of this report, the tests conducted and the correctness of the report contents.

## CPS CONDITIONS OF SERVICE

The party that submits a completed service request form to Company or signs a quotation issued by the Company for its performance of services ("Services") is the "Client" under these Conditions of Service. The entity within the Bureau Veritas Consumer Products Services division accepting the service request form and issuing the Report documenting the results of those Services is the "Company" under these Conditions of Service. Company and Client are, together, the "Parties" and each is a "Party". A request for Services constitutes a legally binding agreement on both Parties when such a request is accepted by the Company ("Agreement") under the following terms and conditions (collectively, "Conditions"):

- 1. Services.** (a) The completion of the Services shall be evidenced by the Company's issuing to Client a written report setting forth the results of the Services based upon the properly accepted request, applicable protocols, written information, and where applicable, the product sample provided by Client to Company ("Report"). Company may delegate/assign the performance of all or a portion of the Services to an affiliate of Company or to an agent or subcontractor. Client shall provide to Company on a timely basis, all documents and information necessary to enable Company to properly perform the Services. Company may, in its sole discretion, dispose of product samples furnished to Company for the Services that were not destroyed in the course of performance of the Services. (b) Client represents and warrants to Company that (i) each product sample is not submitted in violation of a third party's intellectual property rights; (ii) Client will not use and rely upon Company's Report for any product whose properties differ from the sample(s) upon which the Report is based; and (iii) any goods subject to inspection will be completely prepared for the type of inspection booked for the specified date, and (c) Client accepts sole responsibility and liability for the accuracy of documents submitted to government or other regulatory bodies, including certificates of compliance required under the US Consumer Product Safety Improvement Act and EU requirements under REACH regulations. Client's responsibility and liability for accuracy shall apply even where Company has provided assistance to Client in preparation of such documentation.
- 2. Report.** (a) The Report shall (i) constitute the sole deliverable for the Services, (ii) relate solely to the facts and circumstances as observed and recorded by Company at the time of performance of the Services within the limits of written information and instructions received from Client; Company shall have no obligation to update the Report after its issuance. Where the Services include testing or inspection: (i) the Report will set forth the findings of Company solely with respect to the product samples identified therein and (ii) the results set forth in the Report are not to be construed as indicative or representative of the quality or characteristics of the lot from which a product sample was taken for Company's performance of Services. (b) The Report is issued solely by Company, is intended for the exclusive use of Client and its affiliates and, except as required by a regulatory body, shall not be published, used for advertising purposes, copied or replicated for distribution or publicly disclosed without Company's prior written consent. Company is not responsible for any third party's interpretation of the Report. (c) Client shall not request a Report for purposes of litigation, nor shall it list Company, its affiliates or employees as an expert in any proceeding without Company's prior written consent. If Client anticipates producing or otherwise using the Report in any legal proceedings, it shall so notify Company prior to submitting the Report in such proceeding.
- 3. Representations and Warranties.** (a) Company undertakes due care and ordinary skill in the performance of its Services. (b) Client agrees that Company is neither an insurer nor a guarantor and does not take the place of Client or the third parties that it retains, including designers, manufacturers, agents, buyers, distributors, and transportation or shipping companies; Company disclaims all liability in such capacities. Client understands that, if it seeks to protect itself from claims of loss, damage or injury, it should obtain appropriate insurance. (c) Company does not warrant or guarantee Client's products, and Company's Report does not represent a warranty of merchantability, a warranty of fitness for a particular purpose, or any other warranty or guarantee.
- 4. Payment.** Payment in full shall be due 30 days after the date of invoice, failing which Company may revoke any credit extended to Client. Client shall reimburse Company for (i) interest on overdue amounts from the due date until paid at an interest rate of 1.5% per month and (ii) any other costs Company incurs in collecting past due amounts, including court, attorneys and collection agencies' fees.
- 5. Intellectual Property.** The names, service marks, trademarks and copyrights of Company and its affiliates (collectively, the "Marks") are and remain the sole property of Company and shall not be used by Client. Client shall not contest the validity of the Marks or take any action that might impair the value or goodwill associated with the Marks or the image or reputation of Company or its affiliates. Client understands that any information or samples submitted to Company is a license for Company to use the same in the performance of Services.
- 6. Relationship.** (a) Nothing herein creates a partnership, agency or joint venture between the Parties. (b) The failure to require strict observance or performance of any provision of these Conditions shall not be construed to be a waiver of a Party's right to later require strict observance and performance of the same. If any provision of these Conditions is held to be invalid or unenforceable, such invalidity shall not invalidate the remainder of the Conditions. (c) For a period of two years after the commencement of this Agreement, Client shall not directly or indirectly try to solicit for employment any of Company's employees.
- 7. INDEMNITY.** CLIENT SHALL HOLD HARMLESS AND INDEMNIFY COMPANY, ITS AFFILIATES, AND THEIR RESPECTIVE DIRECTORS, OFFICERS, EMPLOYEES, AGENTS AND SUBCONTRACTORS AGAINST ALL THIRD-PARTY CLAIMS FOR LOSS, DAMAGE, INJURY, DEATH, OR EXPENSE OF WHATEVER NATURE, INCLUDING BUT NOT LIMITED TO CLAIMS ARISING FROM OR RELATING TO (I) THE PERFORMANCE OF ANY SERVICES BY COMPANY, (II) THE SALE, RESALE, MANUFACTURE, DISTRIBUTION OR USE OF ANY OF CLIENT'S GOODS OR (III) BREACH OF CLIENT'S OBLIGATIONS OR WARRANTIES HEREIN.
- 8. LIMITATIONS OF LIABILITY.** (A) COMPANY SHALL NOT BE LIABLE FOR ANY INDIRECT, CONSEQUENTIAL OR SPECIAL LOSS IN CONNECTION WITH THE REPORT, THE PRODUCT FOR WHICH SERVICES WERE PERFORMED, OR THE SERVICES PROVIDED BY COMPANY HEREUNDER. COMPANY SHALL NOT BE LIABLE FOR ANY LOSS OR DAMAGE WHATSOEVER RESULTING FROM ANY DELAY IN THE PERFORMANCE OF ITS OBLIGATIONS HEREUNDER OR FROM THE FAILURE OF COMPANY TO PROVIDE ITS SERVICES WITHIN ANY TIME PERIOD FOR COMPLETION ESTIMATED BY COMPANY, REGARDLESS OF THE CAUSE OF THE DELAY OR FAILURE. (B) THE ENTIRE FINANCIAL AND LEGAL LIABILITY OF COMPANY IN RESPECT OF ANY CLAIM FOR LOSS, INDEMNITY, CONTRIBUTION OR DAMAGE OF WHATEVER NATURE OR HOWSOEVER ARISING, SHALL NOT EXCEED AN AMOUNT EQUAL TO FIVE (5) TIMES THE AMOUNT OF FEES PAID TO COMPANY FOR THE SPECIFIC SERVICES WHICH GAVE RISE TO SUCH CLAIM.
- 9. Force Majeure.** If any event of force majeure or any event outside the control of Company occurs, Company may immediately cancel or suspend its performance hereunder without incurring any liability whatsoever to Client.
- 10. Governing Law.** These Conditions shall be governed by the laws of the country as follows: for Services performed in (i) the Americas: the laws of New York, (ii) Asia Pacific, South Asia, Middle East and Africa: the laws of Hong Kong (except for China where PRC laws govern), and (iii) Europe: the laws of England.
- 11. Dispute Resolution.** (a) If Client desires to assert a claim relating to the Services, it must submit the same to Company in writing setting forth with particularity the basis for such claim within 90 days from discovery of the claim and not more than six months after the date of issuance of the Report. Client waives any and all claims without limitation that it does not submit within such time periods. (b) If a dispute arises under this Agreement, the Parties shall first attempt good faith negotiations, failing which, the Parties (i) agree that the courts of the country of governing law shall have exclusive jurisdiction to settle any such dispute related to this Agreement and (ii) irrevocably waive their right to trial by jury in any such action or proceeding.
- 12.** These Conditions, the applicable order form and/or quotation and the Report represent the entire understanding of the Parties on the subject matter hereof, and no modification is binding unless in writing. Any of Client's terms and conditions attached to, enclosed with or referred to in any order form, purchase order or other document shall not apply.





# TEST REPORT

Report No:

(7418)144-0214C(SL)

Jul 14, 2018

Page 2 of 4

## TEST RESULTS

No.	Parameters	Results	LOQ	Unit	Test Method
1	Temperature at Receiving	24.2	-	°C	APHA 20th Edition – 2550B
2	Turbidity	0.1	-	NTU	APHA 2130 B
3	pH at 24°C*	8.4	-	-	FD-MTHD-007:2013 Reference to APHA 4500H+
4	Nitrate (as NO <sub>3</sub> <sup>-</sup> )	0.4	-	mg/l	APHA 4500 -NO <sub>3</sub> - E
5	Oil & Grease*	<2.0	2.0	mg/l	FD-MTHD-032:2013 Reference to APHA 5520B
6	Free Ammonia (as NH <sub>3</sub> )	<0.02	0.02	mg/l	SLS 614 Appendix A: 2013
7	Salinity	37	-	ppt	APHA 2520
<b>Heavy Metals</b>					
8	Arsenic (as As)*	ND	0.001	mg/l	CPSD-AN-00581-MTHD with ICP-MS
9	Cadmium (as Cd)*	ND	0.0001	mg/l	
10	Lead (as Pb)*	ND	0.001	mg/l	
11	Mercury (as Hg)*	ND	0.00005	mg/l	
12	Nickel (as Ni)*	ND	0.001	mg/l	
13	Copper (as Cu)*	ND	0.001	mg/l	
14	Zinc (as Zn)*	0.004	-	mg/l	
15	Chromium (as Cr)	ND	0.001	mg/l	



# TEST REPORT

Report No:

(7418)144-0214C(SL)

Jul 14, 2018

Page 3 of 4

**Remark –**

**\*ISO 17025 :2005 ACCREDITED TEST BY SRI LANKA ACCREDITATION BOARD FOR CONFORMITY ASSESSMENT (SLAB)**

**NOTE:**

mg/l: milligrams per liter, ppt: parts per thousand,  
APHA: American Public Health Association  
ND: Not Detected, LOQ: Limit of Quantification,  
NTU: Nephelometric Turbidity Units, °C : Celcius,  
ICP-MS: Inductively Coupled Plasma – Mass Spectroscopy.

**Contact information for this report (Technical and General Inquiries and Feedback)**

<b>GENERAL INQUIRIES:</b>		
IROSHA UDUGAMPALA	TEL: +94 768 229 528	E-MAIL: Irosha.Udugampala@lk.bureauveritas.com
<b>TECHNICAL INQUIRIES:</b>		
INDRAJITH HATHURUSINGHA	TEL: + 94 769 603 814	E-MAIL: Indrajith.hs@lk.bureauveritas.com
<b>FEED BACK:</b>		
DHANUKA PERERA –EXECUTIVE QHSE	TEL: +94 768 229 479	E-MAIL: dhanuka.perera@lk.bureauveritas.com

REVIEWED BY: SHYAMIKA WICKRAMASINGHE

BUREAU VERITAS CONSUMER PRODUCTS SERVICES LANKA (PVT) LTD.

AUTHORIZED SIGNATORY

APPROVED BY:

  
INDRAJITH HATHURUSINGHA  
MANAGER -  
FOOD LABORATORY



# TEST REPORT

Report No:

(7418)144-0214C(SL)

Jul 14, 2018

Page 4 of 4

## CPS CONDITIONS OF SERVICE

The party that submits a completed service request form to Company or signs a quotation issued by the Company for its performance of services ("Services") is the "Client" under these Conditions of Service. The entity within the Bureau Veritas Consumer Products Services division accepting the service request form and issuing the Report documenting the results of those Services is the "Company" under these Conditions of Service. Company and Client are, together, the "Parties" and each is a "Party". A request for Services constitutes a legally binding agreement on both Parties when such a request is accepted by the Company ("Agreement") under the following terms and conditions (collectively, "Conditions").

**1. Services.** (a) The completion of the Services shall be evidenced by the Company's issuing to Client a written report setting forth the results of the Services based upon the properly accepted request, applicable protocols, written information, and where applicable, the product sample provided by Client to Company ("Report"). Company may delegate/assign the performance of all or a portion of the Services to an affiliate of Company or to an agent or subcontractor. Client shall provide to Company on a timely basis, all documents and information necessary to enable Company to properly perform the Services. Company may, in its sole discretion, dispose of product samples furnished to Company for the Services that were not destroyed in the course of performance of the Services. (b) Client represents and warrants to Company that (i) each product sample is not submitted in violation of a third party's intellectual property rights, (ii) Client will not use and rely upon Company's Report for any product whose properties differ from the samples upon which the Report is based, and (iii) any goods subject to inspection will be completely prepared for the type of inspection booked for the specified date, and (c) Client accepts sole responsibility and liability for the accuracy of documents submitted to government or other regulatory bodies, including certificates of compliance required under the US Consumer Product Safety Improvement Act and EU requirements under REACH regulations. Client's responsibility and liability for accuracy shall apply even where Company has provided assistance to Client in preparation of such documentation.

**2. Report.** (a) The Report shall (i) constitute the sole deliverable for the Services, (ii) relate solely to the facts and circumstances as observed and recorded by Company at the time of performance of the Services within the limits of written information and instructions received from Client, Company shall have no obligation to update the Report after its issuance. Where the Services include testing or inspection (i) the Report will set forth the findings of Company solely with respect to the product samples identified therein and (ii) the results set forth in the Report are not to be construed as indicative or representative of the quality or characteristics of the lot from which a product sample was taken for Company's performance of Services. (b) The Report is issued solely by Company, is intended for the exclusive use of Client and its affiliates and, except as required by a regulatory body, shall not be published, used for advertising purposes, copied or replicated for distribution or publicly disclosed without Company's prior written consent. Company is not responsible for any third party's interpretation of the Report. (c) Client shall not request a Report for purposes of litigation, nor shall it list Company, its affiliates or employees as an expert in any proceeding without Company's prior written consent. If Client anticipates producing or otherwise using the Report in any legal proceedings, it shall so notify Company prior to submitting the Report in such proceeding.

**3. Representations and Warranties.** (a) Company undertakes due care and ordinary skill in the performance of its Services. (b) Client agrees that Company is neither an insurer nor a guarantor and does not take the place of Client or the third parties that it retains, including designers, manufacturers, agents, buyers, distributors, and transportation or shipping companies. Company disclaims all liability in such capacities. Client understands that if it seeks to protect itself from claims of loss, damage or injury, it should obtain appropriate insurance. (c) Company does not warrant or guarantee Client's products, and Company's Report does not represent a warranty of merchantability, a warranty of fitness for a particular purpose, or any other warranty or guarantee.

**4. Payment.** Payment in full shall be due 30 days after the date of invoice, failing which Company may revoke any credit extended to Client. Client shall reimburse Company for (i) interest on overdue amounts from the due date until paid at an interest rate of 1.5% per month and (ii) any other costs Company incurs in collecting past due amounts, including court, attorneys and collection agencies' fees.

**5. Intellectual Property.** The names, service marks, trademarks and copyrights of Company and its affiliates (collectively, the "Marks") are and remain the sole property of Company and shall not be used by Client. Client shall not contest the validity of the Marks or take any action that might impair the value or goodwill associated with the Marks or the image or reputation of Company or its affiliates. Client understands that any information or samples submitted to Company is a license for Company to use the same in the performance of Services.

**6. Relationship.** (a) Nothing herein creates a partnership, agency or joint venture between the Parties. (b) The failure to require strict observance or performance of any provision of these Conditions shall not be construed to be a waiver of a Party's right to later require strict observance and performance of the same. If any provision of these Conditions is held to be invalid or unenforceable, such invalidity shall not invalidate the remainder of the Conditions. (c) For a period of two years after the commencement of this Agreement, Client shall not directly or indirectly try to solicit for employment any of Company's employees.

**7. INDEMNITY.** CLIENT SHALL HOLD HARMLESS AND INDEMNIFY COMPANY, ITS AFFILIATES AND THEIR RESPECTIVE DIRECTORS, OFFICERS, EMPLOYEES, AGENTS AND SUBCONTRACTORS AGAINST ALL THIRD-PARTY CLAIMS FOR LOSS, DAMAGE, INJURY, DEATH OR EXPENSE OF WHATEVER NATURE, INCLUDING BUT NOT LIMITED TO CLAIMS ARISING FROM OR RELATING TO (i) THE PERFORMANCE OF ANY SERVICES BY COMPANY, (ii) THE SALE, RESALE, MANUFACTURE, DISTRIBUTION OR USE OF ANY OF CLIENT'S GOODS OR (iii) BREACH OF CLIENT'S OBLIGATIONS OR WARRANTIES HEREIN.

**8. LIMITATIONS OF LIABILITY.** (A) COMPANY SHALL NOT BE LIABLE FOR ANY INDIRECT, CONSEQUENTIAL OR SPECIAL LOSS IN CONNECTION WITH THE REPORT, THE PRODUCT FOR WHICH SERVICES WERE PERFORMED, OR THE SERVICES PROVIDED BY COMPANY HEREUNDER. COMPANY SHALL NOT BE LIABLE FOR ANY LOSS OR DAMAGE WHATSOEVER RESULTING FROM ANY DELAY IN THE PERFORMANCE OF ITS OBLIGATIONS HEREUNDER OR FROM THE FAILURE OF COMPANY TO PROVIDE ITS SERVICES WITHIN ANY TIME PERIOD FOR COMPLETION ESTIMATED BY COMPANY REGARDLESS OF THE CAUSE OF THE DELAY OR FAILURE. (B) THE ENTIRE FINANCIAL AND LEGAL LIABILITY OF COMPANY IN RESPECT OF ANY CLAIM FOR LOSS, INDEMNITY, CONTRIBUTION OR DAMAGE OF WHATEVER NATURE OR HOWSOEVER ARISING, SHALL NOT EXCEED AN AMOUNT EQUAL TO FIVE (5) TIMES THE AMOUNT OF FEES PAID TO COMPANY FOR THE SPECIFIC SERVICES WHICH GAVE RISE TO SUCH CLAIM.

**9. Force Majeure.** If any event of force majeure or any event outside the control of Company occurs, Company may immediately cancel or suspend its performance hereunder without incurring any liability whatsoever to Client.

**10. Governing Law.** These Conditions shall be governed by the laws of the country as follows: for Services performed in (i) the Americas, the laws of New York; (ii) Asia Pacific, South Asia, Middle East and Africa, the laws of Hong Kong (except for China where PRC laws govern), and (iii) Europe, the laws of England.

**11. Dispute Resolution.** (a) If Client desires to assert a claim relating to the Services, it must submit the same to Company in writing setting forth with particularity the basis for such claim within 90 days from discovery of the claim and not more than six months after the date of issuance of the Report. Client waives any and all claims without limitation that it does not submit within such time periods. (b) If a dispute arises under this Agreement, the Parties shall first attempt good faith negotiations, failing which, the Parties (i) agree that the courts of the country of governing law shall have exclusive jurisdiction to settle any such dispute related to this Agreement and (ii) irrevocably waive their right to trial by jury in any such action or proceeding.

**12. These Conditions, the applicable order form and/or quotation and the Report represent the entire understanding of the Parties on the subject matter hereof, and no modification is binding unless in writing. Any of Client's terms and conditions attached to, enclosed with or referred to in any order form, purchase order or other document shall not apply.**

Gen v 1 copyright 2015 Bureau Veritas

END OF THE REPORT.

**Report No:**

**(7418)144-0214D(SL)**

**Jul 14, 2018**

**Page 1 of 4**

**Applicant:** Water Solutions (Pvt) Ltd.

**Address :** Ma Fas Eri, 1<sup>st</sup> Floor,  
Ameenee Magu,  
Male,  
Maldives.

**Attn:** Mr. Aslam Mohamed/ Mr. Abdulla Fazeel

**Sample Received as:** 500ml x 2 No.s of water sample contained in sealed plastic bottles submitted by the client.

**Sample Described by the Client as:** Thilafushi SW4  
Date & time Sampled : 03/07/2018 at 08.15 a.m

**Date of Sample Received:** Jul 06, 2018

**Date of Testing Started:** Jul 06, 2018

**Date of Testing Completed:** Jul 13, 2018

**Date of Report Issued:** Jul 14, 2018

**Photo of the Submitted Sample**



**The content of this PDF file is in accordance with the original issued reports for reference only.  
This Test Report cannot be reproduced, except in full, without prior written permission of the company.**

**Bureau Veritas Consumer Products Services Lanka (Pvt) Ltd.**

No. 570, Galle Road, Katubedda, Sri Lanka.

Tel : (9411) 2350111 Fax : (9411) 2622198 / 9

E-mail : [bvcp.lanka@lk.bureauveritas.com](mailto:bvcp.lanka@lk.bureauveritas.com)

This report is governed by, and incorporates by reference, the Conditions of Testing as posted at the date of issuance of this report at <http://www.nl-iacl.com/attid> is intended for your exclusive use. Any copying or replication of this report to or for any other person or entity, or use of our name or trademark, is permitted only with our prior written permission. This report sets forth our findings solely with respect to the test samples identified herein. The results set forth in this report are not indicative or representative of the quality or characteristics of the lot from which a test sample was taken or any similar or identical product unless specifically and expressly noted. Our report includes all of the tests requested by you and the results thereof based upon the information that you provided to us. You have 60 days from date of issuance of this report to notify us of any material error or omission caused by our negligence, provided, however, that such notice shall be in writing and shall specifically address the issue you wish to raise. A failure to raise such issue within the prescribed time shall constitute your unqualified acceptance of the completeness of this report, the tests conducted and the correctness of the report contents.

## CPS CONDITIONS OF SERVICE

The party that submits a completed service request form to Company or signs a quotation issued by the Company for its performance of services ("**Services**") is the "**Client**" under these Conditions of Service. The entity within the Bureau Veritas Consumer Products Services division accepting the service request form and issuing the Report documenting the results of those Services is the "**Company**" under these Conditions of Service. Company and Client are, together, the "**Parties**" and each is a "**Party**". A request for Services constitutes a legally binding agreement on both Parties when such a request is accepted by the Company ("**Agreement**") under the following terms and conditions (collectively, "**Conditions**"):

**1. Services.** (a) The completion of the Services shall be evidenced by the Company's issuing to Client a written report setting forth the results of the Services based upon the properly accepted request, applicable protocols, written information, and where applicable, the product sample provided by Client to Company ("**Report**"). Company may delegate/assign the performance of all or a portion of the Services to an affiliate of Company or to an agent or subcontractor. Client shall provide to Company on a timely basis, all documents and information necessary to enable Company to properly perform the Services. Company may, in its sole discretion, dispose of product samples furnished to Company for the Services that were not destroyed in the course of performance of the Services. (b) Client represents and warrants to Company that (i) each product sample is not submitted in violation of a third party's intellectual property rights; (ii) Client will not use and rely upon Company's Report for any product whose properties differ from the sample(s) upon which the Report is based; and (iii) any goods subject to inspection will be completely prepared for the type of inspection booked for the specified date, and (c) Client accepts sole responsibility and liability for the accuracy of documents submitted to government or other regulatory bodies, including certificates of compliance required under the US Consumer Product Safety Improvement Act and EU requirements under REACH regulations. Client's responsibility and liability for accuracy shall apply even where Company has provided assistance to Client in preparation of such documentation.

**2. Report.** (a) The Report shall (i) constitute the sole deliverable for the Services, (ii) relate solely to the facts and circumstances as observed and recorded by Company at the time of performance of the Services within the limits of written information and instructions received from Client; Company shall have no obligation to update the Report after its issuance. Where the Services include testing or inspection: (i) the Report will set forth the findings of Company solely with respect to the product samples identified therein and (ii) the results set forth in the Report are not to be construed as indicative or representative of the quality or characteristics of the lot from which a product sample was taken for Company's performance of Services. (b) The Report is issued solely by Company, is intended for the exclusive use of Client and its affiliates and, except as required by a regulatory body, shall not be published, used for advertising purposes, copied or replicated for distribution or publicly disclosed without Company's prior written consent. Company is not responsible for any third party's interpretation of the Report. (c) Client shall not request a Report for purposes of litigation, nor shall it list Company, its affiliates or employees as an expert in any proceeding without Company's prior written consent. If Client anticipates producing or otherwise using the Report in any legal proceedings, it shall so notify Company prior to submitting the Report in such proceeding.

**3. Representations and Warranties.** (a) Company undertakes due care and ordinary skill in the performance of its Services. (b) Client agrees that Company is neither an insurer nor a guarantor and does not take the place of Client or the third parties that it retains, including designers, manufacturers, agents, buyers, distributors, and transportation or shipping companies; Company disclaims all liability in such capacities. Client understands that, if it seeks to protect itself from claims of loss, damage or injury, it should obtain appropriate insurance. (c) Company does not warrant or guarantee Client's products, and Company's Report does not represent a warranty of merchantability, a warranty of fitness for a particular purpose, or any other warranty or guarantee.

**4. Payment.** Payment in full shall be due 30 days after the date of invoice, failing which Company may revoke any credit extended to Client. Client shall reimburse Company for (i) interest on overdue amounts from the due date until paid at an interest rate of 1.5% per month and (ii) any other costs Company incurs in collecting past due amounts, including court, attorneys and collection agencies' fees.

**5. Intellectual Property.** The names, service marks, trademarks and copyrights of Company and its affiliates (collectively, the "**Marks**") are and remain the sole property of Company and shall not be used by Client. Client shall not contest the validity of the Marks or take any action that might impair the value or goodwill associated with the Marks or the image or reputation of Company or its affiliates. Client understands that any information or samples submitted to Company is a license for Company to use the same in the performance of Services.

**6. Relationship.** (a) Nothing herein creates a partnership, agency or joint venture between the Parties. (b) The failure to require strict observance or performance of any provision of these Conditions shall not be construed to be a waiver of a Party's right to later require strict observance and performance of the same. If any provision of these Conditions is held to be invalid or unenforceable, such invalidity shall not invalidate the remainder of the Conditions. (c) For a period of two years after the commencement of this Agreement, Client shall not directly or indirectly try to solicit for employment any of Company's employees.

**7. INDEMNITY.** CLIENT SHALL HOLD HARMLESS AND INDEMNIFY COMPANY, ITS AFFILIATES, AND THEIR RESPECTIVE DIRECTORS, OFFICERS, EMPLOYEES, AGENTS AND SUBCONTRACTORS AGAINST ALL THIRD-PARTY CLAIMS FOR LOSS, DAMAGE, INJURY, DEATH, OR EXPENSE OF WHATEVER NATURE, INCLUDING BUT NOT LIMITED TO CLAIMS ARISING FROM OR RELATING TO (I) THE PERFORMANCE OF ANY SERVICES BY COMPANY, (II) THE SALE, RESALE, MANUFACTURE, DISTRIBUTION OR USE OF ANY OF CLIENT'S GOODS OR (III) BREACH OF CLIENT'S OBLIGATIONS OR WARRANTIES HEREIN.

**8. LIMITATIONS OF LIABILITY.** (A) COMPANY SHALL NOT BE LIABLE FOR ANY INDIRECT, CONSEQUENTIAL OR SPECIAL LOSS IN CONNECTION WITH THE REPORT, THE PRODUCT FOR WHICH SERVICES WERE PERFORMED, OR THE SERVICES PROVIDED BY COMPANY HEREUNDER. COMPANY SHALL NOT BE LIABLE FOR ANY LOSS OR DAMAGE WHATSOEVER RESULTING FROM ANY DELAY IN THE PERFORMANCE OF ITS OBLIGATIONS HEREUNDER OR FROM THE FAILURE OF COMPANY TO PROVIDE ITS SERVICES WITHIN ANY TIME PERIOD FOR COMPLETION ESTIMATED BY COMPANY, REGARDLESS OF THE CAUSE OF THE DELAY OR FAILURE. (B) THE ENTIRE FINANCIAL AND LEGAL LIABILITY OF COMPANY IN RESPECT OF ANY CLAIM FOR LOSS, INDEMNITY, CONTRIBUTION OR DAMAGE OF WHATEVER NATURE OR HOWSOEVER ARISING, SHALL NOT EXCEED AN AMOUNT EQUAL TO FIVE (5) TIMES THE AMOUNT OF FEES PAID TO COMPANY FOR THE SPECIFIC SERVICES WHICH GAVE RISE TO SUCH CLAIM.

**9. Force Majeure.** If any event of force majeure or any event outside the control of Company occurs, Company may immediately cancel or suspend its performance hereunder without incurring any liability whatsoever to Client.

**10. Governing Law.** These Conditions shall be governed by the laws of the country as follows: for Services performed in (i) the Americas: the laws of New York, (ii) Asia Pacific, South Asia, Middle East and Africa: the laws of Hong Kong (except for China where PRC laws govern), and (iii) Europe: the laws of England.

**11. Dispute Resolution.** (a) If Client desires to assert a claim relating to the Services, it must submit the same to Company in writing setting forth with particularity the basis for such claim within 90 days from discovery of the claim and not more than six months after the date of issuance of the Report. Client waives any and all claims without limitation that it does not submit within such time periods. (b) If a dispute arises under this Agreement, the Parties shall first attempt good faith negotiations, failing which, the Parties (i) agree that the courts of the country of governing law shall have exclusive jurisdiction to settle any such dispute related to this Agreement and (ii) irrevocably waive their right to trial by jury in any such action or proceeding.

**12.** These Conditions, the applicable order form and/or quotation and the Report represent the entire understanding of the Parties on the subject matter hereof, and no modification is binding unless in writing. Any of Client's terms and conditions attached to, enclosed with or referred to in any order form, purchase order or other document shall not apply.



# TEST REPORT

Report No:

(7418)144-0214D(SL)

Jul 14, 2018

Page 2 of 4

## TEST RESULTS

No.	Parameters	Results	LOQ	Unit	Test Method
1	Temperature at Receiving	24.2	-	°C	APHA 20th Edition – 2550B
2	Turbidity	0.2	-	NTU	APHA 2130 B
3	pH at 24°C*	8.4	-	-	FD-MTHD-007:2013 Reference to APHA 4500H+
4	Nitrate (as NO <sub>3</sub> <sup>-</sup> )	0.4	-	mg/l	APHA 4500 -NO <sub>3</sub> - E
5	Oil & Grease*	<2.0	2.0	mg/l	FD-MTHD-032:2013 Reference to APHA 5520B
6	Free Ammonia (as NH <sub>3</sub> )	<0.02	0.02	mg/l	SLS 614 Appendix A: 2013
7	Salinity	37	-	ppt	APHA 2520
<b>Heavy Metals</b>					
8	Arsenic (as As)*	ND	0.001	mg/l	CPSD-AN-00581-MTHD with ICP-MS
9	Cadmium (as Cd)*	ND	0.0001	mg/l	
10	Lead (as Pb)*	ND	0.001	mg/l	
11	Mercury (as Hg)*	ND	0.00005	mg/l	
12	Nickel (as Ni)*	ND	0.001	mg/l	
13	Copper (as Cu)*	ND	0.001	mg/l	
14	Zinc (as Zn)*	ND	0.001	mg/l	
15	Chromium (as Cr)	ND	0.001	mg/l	



# TEST REPORT

Report No:

(7418)144-0214D(SL)

Jul 14, 2018

Page 3 of 4

**Remark –**

**\*ISO 17025 :2005 ACCREDITED TEST BY SRI LANKA ACCREDITATION BOARD FOR CONFORMITY ASSESSMENT (SLAB)**

**NOTE:**

mg/l: milligrams per liter, ppt: parts per thousand,  
APHA: American Public Health Association  
ND: Not Detected, LOQ: Limit of Quantification,  
NTU: Nephelometric Turbidity Units, °C : Celcius,  
ICP-MS: Inductively Coupled Plasma – Mass Spectroscopy.

**Contact information for this report (Technical and General Inquiries and Feedback)**

GENERAL INQUIRIES:		
IROSHA UDUGAMPALA	TEL: +94 768 229 528	E-MAIL: Irosha.Udugampala@lk.bureauveritas.com
TECHNICAL INQUIRIES:		
INDRAJITH HATHURUSINGHA	TEL: + 94 769 603 814	E-MAIL: Indrajith.hs@lk.bureauveritas.com
FEED BACK:		
DHANUKA PERERA –EXECUTIVE QHSE	TEL: +94 768 229 479	E-MAIL: dhanuka.perera@lk.bureauveritas.com

REVIEWED BY: SHYAMIKA WICKRAMASINGHE

BUREAU VERITAS CONSUMER PRODUCTS SERVICES LANKA (PVT) LTD.

AUTHORIZED SIGNATORY

APPROVED BY:

INDRAJITH HATHURUSINGHA  
MANAGER -  
FOOD LABORATORY



**BUREAU  
VERITAS**

# TEST REPORT

Report No:

(7418)144-0214D(SL)

Jul 14, 2018

Page 4 of 4

## CPS CONDITIONS OF SERVICE

The party that submits a completed service request form to Company or signs a quotation issued by the Company for its performance of services ("Services") is the "Client" under these Conditions of Service. The entity within the Bureau Veritas Consumer Products Services division accepting the service request form and issuing the Report documenting the results of those Services is the "Company" under these Conditions of Service. Company and Client are, together, the "Parties" and each is a "Party". A request for Services constitutes a legally binding agreement on both Parties when such a request is accepted by the Company ("Agreement") under the following terms and conditions (collectively, "Conditions").

**1. Services.** (a) The completion of the Services shall be evidenced by the Company's issuing to Client a written report setting forth the results of the Services based upon the properly accepted request, applicable protocols, written information, and where applicable, the product sample provided by Client to Company ("Report"). Company may delegate/assign the performance of all or a portion of the Services to an affiliate of Company or to an agent or subcontractor. Client shall provide to Company on a timely basis, all documents and information necessary to enable Company to properly perform the Services. Company may, in its sole discretion, dispose of product samples furnished to Company for the Services that were not destroyed in the course of performance of the Services. (b) Client represents and warrants to Company that (i) each product sample is not submitted in violation of a third party's intellectual property rights, (ii) Client will not use and rely upon Company's Report for any product whose properties differ from the samples upon which the Report is based, and (iii) any goods subject to inspection will be completely prepared for the type of inspection booked for the specified date, and (c) Client accepts sole responsibility and liability for the accuracy of documents submitted to government or other regulatory bodies, including certificates of compliance required under the US Consumer Product Safety Improvement Act and EU requirements under REACH regulations. Client's responsibility and liability for accuracy shall apply even where Company has provided assistance to Client in preparation of such documentation.

**2. Report.** (a) The Report shall (i) constitute the sole deliverable for the Services, (ii) relate solely to the facts and circumstances as observed and recorded by Company at the time of performance of the Services within the limits of written information and instructions received from Client, Company shall have no obligation to update the Report after its issuance. Where the Services include testing or inspection, (i) the Report will set forth the findings of Company solely with respect to the product samples identified therein and (ii) the results set forth in the Report are not to be construed as indicative or representative of the quality or characteristics of the lot from which a product sample was taken for Company's performance of Services. (b) The Report is issued solely by Company, is intended for the exclusive use of Client and its affiliates and, except as required by a regulatory body, shall not be published, used for advertising purposes, copied or replicated for distribution or publicly disclosed without Company's prior written consent. Company is not responsible for any third party's interpretation of the Report. (c) Client shall not request a Report for purposes of litigation, nor shall it list Company, its affiliates or employees as an expert in any proceeding without Company's prior written consent. If Client anticipates producing or otherwise using the Report in any legal proceedings, it shall so notify Company prior to submitting the Report in such proceeding.

**3. Representations and Warranties.** (a) Company undertakes due care and ordinary skill in the performance of its Services. (b) Client agrees that Company is neither an insurer nor a guarantor and does not take the place of Client or the third parties that it retains, including designers, manufacturers, agents, buyers, distributors, and transportation or shipping companies. Company disclaims all liability in such capacities. Client understands that, if it seeks to protect itself from claims of loss, damage or injury, it should obtain appropriate insurance. (c) Company does not warrant or guarantee Client's products, and Company's Report does not represent a warranty of merchantability, a warranty of fitness for a particular purpose, or any other warranty or guarantee.

**4. Payment.** Payment in full shall be due 30 days after the date of invoice, failing which Company may revoke any credit extended to Client. Client shall reimburse Company for (i) interest on overdue amounts from the due date until paid at an interest rate of 1.5% per month and (ii) any other costs Company incurs in collecting past due amounts, including court, attorneys and collection agencies fees.

**5. Intellectual Property.** The names, service marks, trademarks and copyrights of Company and its affiliates (collectively, the "Marks") are and remain the sole property of Company and shall not be used by Client. Client shall not contest the validity of the Marks or take any action that might impair the value or goodwill associated with the Marks or the image or reputation of Company or its affiliates. Client understands that any information or samples submitted to Company is a license for Company to use the same in the performance of Services.

**6. Relationship.** (a) Nothing herein creates a partnership, agency or joint venture between the Parties. (b) The failure to require strict observance or performance of any provision of these Conditions shall not be construed to be a waiver of a Party's right to later require strict observance and performance of the same. If any provision of these Conditions is held to be invalid or unenforceable, such invalidity shall not invalidate the remainder of the Conditions. (c) For a period of two years after the commencement of this Agreement, Client shall not directly or indirectly try to solicit for employment any of Company's employees.

**7. INDEMNITY.** CLIENT SHALL HOLD HARMLESS AND INDEMNIFY COMPANY, ITS AFFILIATES, AND THEIR RESPECTIVE DIRECTORS, OFFICERS, EMPLOYEES, AGENTS AND SUBCONTRACTORS AGAINST ALL THIRD-PARTY CLAIMS FOR LOSS, DAMAGE, INJURY, DEATH, OR EXPENSE OF WHATEVER NATURE, INCLUDING BUT NOT LIMITED TO CLAIMS ARISING FROM OR RELATING TO (i) THE PERFORMANCE OF ANY SERVICES BY COMPANY, (ii) THE SALE, RESALE, MANUFACTURE, DISTRIBUTION OR USE OF ANY OF CLIENT'S GOODS OR (iii) BREACH OF CLIENT'S OBLIGATIONS OR WARRANTIES HEREIN.

**8. LIMITATIONS OF LIABILITY.** (A) COMPANY SHALL NOT BE LIABLE FOR ANY INDIRECT, CONSEQUENTIAL OR SPECIAL LOSS IN CONNECTION WITH THE REPORT, THE PRODUCT FOR WHICH SERVICES WERE PERFORMED, OR THE SERVICES PROVIDED BY COMPANY HEREUNDER. COMPANY SHALL NOT BE LIABLE FOR ANY LOSS OR DAMAGE WHATSOEVER RESULTING FROM ANY DELAY IN THE PERFORMANCE OF ITS OBLIGATIONS HEREUNDER OR FROM THE FAILURE OF COMPANY TO PROVIDE ITS SERVICES WITHIN ANY TIME PERIOD FOR COMPLETION ESTIMATED BY COMPANY REGARDLESS OF THE CAUSE OF THE DELAY OR FAILURE. (B) THE ENTIRE FINANCIAL AND LEGAL LIABILITY OF COMPANY IN RESPECT OF ANY CLAIM FOR LOSS, INDEMNITY, CONTRIBUTION OR DAMAGE OF WHATEVER NATURE OR HOWSOEVER ARISING, SHALL NOT EXCEED AN AMOUNT EQUAL TO FIVE (5) TIMES THE AMOUNT OF FEES PAID TO COMPANY FOR THE SPECIFIC SERVICES WHICH GAVE RISE TO SUCH CLAIM.

**9. Force Majeure.** If any event of force majeure or any event outside the control of Company occurs, Company may immediately cancel or suspend its performance hereunder without incurring any liability whatsoever to Client.

**10. Governing Law.** These Conditions shall be governed by the laws of the country as follows: for Services performed in (i) the Americas, the laws of New York; (ii) Asia Pacific, South Asia, Middle East and Africa, the laws of Hong Kong (except for China where PRC laws govern); and (iii) Europe, the laws of England.

**11. Dispute Resolution.** (a) If Client desires to assert a claim relating to the Services, it must submit the same to Company in writing setting forth with particularity the basis for such claim within 90 days from discovery of the claim and not more than six months after the date of issuance of the Report. Client waives any and all claims without limitation that it does not submit within such time periods. (b) If a dispute arises under this Agreement, the Parties shall first attempt good faith negotiations, failing which, the Parties (i) agree that the courts of the country of governing law shall have exclusive jurisdiction to settle any such dispute related to this Agreement and (ii) irrevocably waive their right to trial by jury in any such action or proceeding.

**12.** These Conditions, the applicable order form and/or quotation and the Report represent the entire understanding of the Parties on the subject matter hereof, and no modification is binding unless in writing. Any of Client's terms and conditions attached to, enclosed with or referred to in any order form, purchase order or other document shall not apply.

Gen v 1 copyright 2015 Bureau Veritas

**END OF THE REPORT.**



**Report No:**

**(7418)144-0214E(SL)**

**Jul 14, 2018**

**Page 1 of 4**

**Applicant:** Water Solutions (Pvt) Ltd.

**Address :** Ma Fas Eri, 1<sup>st</sup> Floor,  
Ameenee Magu,  
Male,  
Maldives.

**Attn:** Mr. Aslam Mohamed/ Mr. Abdulla Fazeel

**Sample Received as:** 500ml x 2 No.s of water sample contained in sealed plastic bottles submitted by the client.

**Sample Described by the Client as:** Thilafushi SW5  
Date & time Sampled : 03/07/2018 at 08.30 a.m

**Date of Sample Received:** Jul 06, 2018

**Date of Testing Started:** Jul 06, 2018

**Date of Testing Completed:** Jul 13, 2018

**Date of Report Issued:** Jul 14, 2018

**Photo of the Submitted Sample**



**The content of this PDF file is in accordance with the original issued reports for reference only.  
This Test Report cannot be reproduced, except in full, without prior written permission of the company.**

## CPS CONDITIONS OF SERVICE

The party that submits a completed service request form to Company or signs a quotation issued by the Company for its performance of services ("Services") is the "Client" under these Conditions of Service. The entity within the Bureau Veritas Consumer Products Services division accepting the service request form and issuing the Report documenting the results of those Services is the "Company" under these Conditions of Service. Company and Client are, together, the "Parties" and each is a "Party". A request for Services constitutes a legally binding agreement on both Parties when such a request is accepted by the Company ("Agreement") under the following terms and conditions (collectively, "Conditions"):

- 1. Services.** (a) The completion of the Services shall be evidenced by the Company's issuing to Client a written report setting forth the results of the Services based upon the properly accepted request, applicable protocols, written information, and where applicable, the product sample provided by Client to Company ("Report"). Company may delegate/assign the performance of all or a portion of the Services to an affiliate of Company or to an agent or subcontractor. Client shall provide to Company on a timely basis, all documents and information necessary to enable Company to properly perform the Services. Company may, in its sole discretion, dispose of product samples furnished to Company for the Services that were not destroyed in the course of performance of the Services. (b) Client represents and warrants to Company that (i) each product sample is not submitted in violation of a third party's intellectual property rights; (ii) Client will not use and rely upon Company's Report for any product whose properties differ from the sample(s) upon which the Report is based; and (iii) any goods subject to inspection will be completely prepared for the type of inspection booked for the specified date, and (c) Client accepts sole responsibility and liability for the accuracy of documents submitted to government or other regulatory bodies, including certificates of compliance required under the US Consumer Product Safety Improvement Act and EU requirements under REACH regulations. Client's responsibility and liability for accuracy shall apply even where Company has provided assistance to Client in preparation of such documentation.
- 2. Report.** (a) The Report shall (i) constitute the sole deliverable for the Services, (ii) relate solely to the facts and circumstances as observed and recorded by Company at the time of performance of the Services within the limits of written information and instructions received from Client; Company shall have no obligation to update the Report after its issuance. Where the Services include testing or inspection: (i) the Report will set forth the findings of Company solely with respect to the product samples identified therein and (ii) the results set forth in the Report are not to be construed as indicative or representative of the quality or characteristics of the lot from which a product sample was taken for Company's performance of Services. (b) The Report is issued solely by Company, is intended for the exclusive use of Client and its affiliates and, except as required by a regulatory body, shall not be published, used for advertising purposes, copied or replicated for distribution or publicly disclosed without Company's prior written consent. Company is not responsible for any third party's interpretation of the Report. (c) Client shall not request a Report for purposes of litigation, nor shall it list Company, its affiliates or employees as an expert in any proceeding without Company's prior written consent. If Client anticipates producing or otherwise using the Report in any legal proceedings, it shall so notify Company prior to submitting the Report in such proceeding.
- 3. Representations and Warranties.** (a) Company undertakes due care and ordinary skill in the performance of its Services. (b) Client agrees that Company is neither an insurer nor a guarantor and does not take the place of Client or the third parties that it retains, including designers, manufacturers, agents, buyers, distributors, and transportation or shipping companies; Company disclaims all liability in such capacities. Client understands that, if it seeks to protect itself from claims of loss, damage or injury, it should obtain appropriate insurance. (c) Company does not warrant or guarantee Client's products, and Company's Report does not represent a warranty of merchantability, a warranty of fitness for a particular purpose, or any other warranty or guarantee.
- 4. Payment.** Payment in full shall be due 30 days after the date of invoice, failing which Company may revoke any credit extended to Client. Client shall reimburse Company for (i) interest on overdue amounts from the due date until paid at an interest rate of 1.5% per month and (ii) any other costs Company incurs in collecting past due amounts, including court, attorneys and collection agencies' fees.
- 5. Intellectual Property.** The names, service marks, trademarks and copyrights of Company and its affiliates (collectively, the "Marks") are and remain the sole property of Company and shall not be used by Client. Client shall not contest the validity of the Marks or take any action that might impair the value or goodwill associated with the Marks or the image or reputation of Company or its affiliates. Client understands that any information or samples submitted to Company is a license for Company to use the same in the performance of Services.
- 6. Relationship.** (a) Nothing herein creates a partnership, agency or joint venture between the Parties. (b) The failure to require strict observance or performance of any provision of these Conditions shall not be construed to be a waiver of a Party's right to later require strict observance and performance of the same. If any provision of these Conditions is held to be invalid or unenforceable, such invalidity shall not invalidate the remainder of the Conditions. (c) For a period of two years after the commencement of this Agreement, Client shall not directly or indirectly try to solicit for employment any of Company's employees.
- 7. INDEMNITY.** CLIENT SHALL HOLD HARMLESS AND INDEMNIFY COMPANY, ITS AFFILIATES, AND THEIR RESPECTIVE DIRECTORS, OFFICERS, EMPLOYEES, AGENTS AND SUBCONTRACTORS AGAINST ALL THIRD-PARTY CLAIMS FOR LOSS, DAMAGE, INJURY, DEATH, OR EXPENSE OF WHATEVER NATURE, INCLUDING BUT NOT LIMITED TO CLAIMS ARISING FROM OR RELATING TO (I) THE PERFORMANCE OF ANY SERVICES BY COMPANY, (II) THE SALE, RESALE, MANUFACTURE, DISTRIBUTION OR USE OF ANY OF CLIENT'S GOODS OR (III) BREACH OF CLIENT'S OBLIGATIONS OR WARRANTIES HEREIN.
- 8. LIMITATIONS OF LIABILITY.** (A) COMPANY SHALL NOT BE LIABLE FOR ANY INDIRECT, CONSEQUENTIAL OR SPECIAL LOSS IN CONNECTION WITH THE REPORT, THE PRODUCT FOR WHICH SERVICES WERE PERFORMED, OR THE SERVICES PROVIDED BY COMPANY HEREUNDER. COMPANY SHALL NOT BE LIABLE FOR ANY LOSS OR DAMAGE WHATSOEVER RESULTING FROM ANY DELAY IN THE PERFORMANCE OF ITS OBLIGATIONS HEREUNDER OR FROM THE FAILURE OF COMPANY TO PROVIDE ITS SERVICES WITHIN ANY TIME PERIOD FOR COMPLETION ESTIMATED BY COMPANY, REGARDLESS OF THE CAUSE OF THE DELAY OR FAILURE. (B) THE ENTIRE FINANCIAL AND LEGAL LIABILITY OF COMPANY IN RESPECT OF ANY CLAIM FOR LOSS, INDEMNITY, CONTRIBUTION OR DAMAGE OF WHATEVER NATURE OR HOWSOEVER ARISING, SHALL NOT EXCEED AN AMOUNT EQUAL TO FIVE (5) TIMES THE AMOUNT OF FEES PAID TO COMPANY FOR THE SPECIFIC SERVICES WHICH GAVE RISE TO SUCH CLAIM.
- 9. Force Majeure.** If any event of force majeure or any event outside the control of Company occurs, Company may immediately cancel or suspend its performance hereunder without incurring any liability whatsoever to Client.
- 10. Governing Law.** These Conditions shall be governed by the laws of the country as follows: for Services performed in (i) the Americas: the laws of New York, (ii) Asia Pacific, South Asia, Middle East and Africa: the laws of Hong Kong (except for China where PRC laws govern), and (iii) Europe: the laws of England.
- 11. Dispute Resolution.** (a) If Client desires to assert a claim relating to the Services, it must submit the same to Company in writing setting forth with particularity the basis for such claim within 90 days from discovery of the claim and not more than six months after the date of issuance of the Report. Client waives any and all claims without limitation that it does not submit within such time periods. (b) If a dispute arises under this Agreement, the Parties shall first attempt good faith negotiations, failing which, the Parties (i) agree that the courts of the country of governing law shall have exclusive jurisdiction to settle any such dispute related to this Agreement and (ii) irrevocably waive their right to trial by jury in any such action or proceeding.
- 12.** These Conditions, the applicable order form and/or quotation and the Report represent the entire understanding of the Parties on the subject matter hereof, and no modification is binding unless in writing. Any of Client's terms and conditions attached to, enclosed with or referred to in any order form, purchase order or other document shall not apply.



**BUREAU  
VERITAS**

# TEST REPORT

Report No:

(7418)144-0214E(SL)

Jul 14, 2018

Page 2 of 4

## TEST RESULTS

No.	Parameters	Results	LOQ	Unit	Test Method
1	Temperature at Receiving	24.2	-	°C	APHA 20th Edition – 2550B
2	Turbidity	0.3	-	NTU	APHA 2130 B
3	pH at 24°C*	8.4	-	-	FD-MTHD-007:2013 Reference to APHA 4500H+
4	Nitrate (as NO <sub>3</sub> <sup>-</sup> )	0.5	-	mg/l	APHA 4500 -NO <sub>3</sub> - E
5	Oil & Grease*	<2.0	2.0	mg/l	FD-MTHD-032:2013 Reference to APHA 5520B
6	Free Ammonia (as NH <sub>3</sub> )	0.05	-	mg/l	SLS 614 Appendix A: 2013
7	Salinity	36	-	ppt	APHA 2520
<b>Heavy Metals</b>					
8	Arsenic (as As)*	ND	0.001	mg/l	CPSD-AN-00581-MTHD with ICP-MS
9	Cadmium (as Cd)*	ND	0.0001	mg/l	
10	Lead (as Pb)*	ND	0.001	mg/l	
11	Mercury (as Hg)*	ND	0.00005	mg/l	
12	Nickel (as Ni)*	ND	0.001	mg/l	
13	Copper (as Cu)*	ND	0.001	mg/l	
14	Zinc (as Zn)*	ND	0.001	mg/l	
15	Chromium (as Cr)	ND	0.001	mg/l	



# TEST REPORT

Report No:

(7418)144-0214E(SL)

Jul 14, 2018

Page 3 of 4

**Remark –**

**\*ISO 17025 :2005 ACCREDITED TEST BY SRI LANKA ACCREDITATION BOARD FOR CONFORMITY ASSESSMENT (SLAB)**

**NOTE:**

mg/l: milligrams per liter, ppt: parts per thousand,  
APHA: American Public Health Association  
ND: Not Detected, LOQ: Limit of Quantification,  
NTU: Nephelometric Turbidity Units, °C : Celcius,  
ICP-MS: Inductively Coupled Plasma – Mass Spectroscopy.

**Contact information for this report (Technical and General Inquiries and Feedback)**


<b>GENERAL INQUIRIES:</b>		
IROSHA UDUGAMPALA	TEL: +94 768 229 528	E-MAIL: Irosha.Udugampala@lk.bureauveritas.com
<b>TECHNICAL INQUIRIES:</b>		
INDRAJITH HATHURUSINGHA	TEL: + 94 769 603 814	E-MAIL: Indrajith.hs@lk.bureauveritas.com
<b>FEED BACK:</b>		
DHANUKA PERERA –EXECUTIVE QHSE	TEL: +94 768 229 479	E-MAIL: dhanuka.perera@lk.bureauveritas.com

REVIEWED BY: SHYAMIKA WICKRAMASINGHE

BUREAU VERITAS CONSUMER PRODUCTS SERVICES LANKA (PVT) LTD.

AUTHORIZED SIGNATORY

APPROVED BY:

  
INDRAJITH HATHURUSINGHA  
MANAGER -  
FOOD LABORATORY



# TEST REPORT

Report No:

(7418)144-0214E(SL)

Jul 14, 2018

Page 4 of 4

## CPS CONDITIONS OF SERVICE

The party that submits a completed service request form to Company or signs a quotation issued by the Company for its performance of services ("Services") is the "Client" under these Conditions of Service. The entity within the Bureau Veritas Consumer Products Services division accepting the service request form and issuing the Report documenting the results of those Services is the "Company" under these Conditions of Service. Company and Client are, together, the "Parties" and each is a "Party". A request for Services constitutes a legally binding agreement on both Parties when such a request is accepted by the Company ("Agreement") under the following terms and conditions (collectively, "Conditions").

1. **Services.** (a) The completion of the Services shall be evidenced by the Company's issuing to Client a written report setting forth the results of the Services based upon the properly accepted request, applicable protocols, written information and where applicable, the product sample provided by Client to Company ("Report"). Company may delegate/assign the performance of all or a portion of the Services to an affiliate of Company or to an agent or subcontractor. Client shall provide to Company on a timely basis, all documents and information necessary to enable Company to properly perform the Services. Company may, in its sole discretion, dispose of product samples furnished to Company for the Services that were not destroyed in the course of performance of the Services. (b) Client represents and warrants to Company that (i) each product sample is not submitted in violation of a third party's intellectual property rights, (ii) Client will not use and rely upon Company's Report for any product whose properties differ from the sample(s) upon which the Report is based; and (iii) any goods subject to inspection will be completely prepared for the type of inspection booked for the specified date, and (c) Client accepts sole responsibility and liability for the accuracy of documents submitted to government or other regulatory bodies, including certificates of compliance required under the US Consumer Product Safety Improvement Act and EU requirements under REACH regulations. Client's responsibility and liability for accuracy shall apply even where Company has provided assistance to Client in preparation of such documentation.

2. **Report.** (a) The Report shall (i) constitute the sole deliverable for the Services, (ii) relate solely to the facts and circumstances as observed and recorded by Company at the time of performance of the Services within the limits of written information and instructions received from Client. Company shall have no obligation to update the Report after its issuance. Where the Services include testing or inspection (i) the Report will set forth the findings of Company solely with respect to the product samples identified therein and (ii) the results set forth in the Report are not to be construed as indicative or representative of the quality or characteristics of the lot from which a product sample was taken for Company's performance of Services. (b) The Report is issued solely by Company, is intended for the exclusive use of Client and its affiliates and, except as required by a regulatory body, shall not be published, used for advertising purposes, copied or replicated for distribution or publicly disclosed without Company's prior written consent. Company is not responsible for any third party's interpretation of the Report. (c) Client shall not request a Report for purposes of litigation, nor shall it list Company, its affiliates or employees as an expert in any proceeding without Company's prior written consent. If Client anticipates producing or otherwise using the Report in any legal proceedings, it shall so notify Company prior to submitting the Report in such proceeding.

3. **Representations and Warranties.** (a) Company undertakes due care and ordinary skill in the performance of its Services. (b) Client agrees that Company is neither an insurer nor a guarantor and does not take the place of Client or the third parties that it retains, including designers, manufacturers, agents, buyers, distributors, and transportation or shipping companies. Company disclaims all liability in such capacities. Client understands that, if it seeks to protect itself from claims of loss, damage or injury, it should obtain appropriate insurance. (c) Company does not warrant or guarantee Client's products, and Company's Report does not represent a warranty of merchantability, a warranty of fitness for a particular purpose, or any other warranty or guarantee.

4. **Payment.** Payment in full shall be due 30 days after the date of invoice, failing which Company may revoke any credit extended to Client. Client shall reimburse Company for (i) interest on overdue amounts from the due date until paid at an interest rate of 1.5% per month and (ii) any other costs Company incurs in collecting past due amounts, including court, attorneys and collection agencies' fees.

5. **Intellectual Property.** The names, service marks, trademarks and copyrights of Company and its affiliates (collectively, the "Marks") are and remain the sole property of Company and shall not be used by Client. Client shall not contest the validity of the Marks or take any action that might impair the value or goodwill associated with the Marks or the image or reputation of Company or its affiliates. Client understands that any information or samples submitted to Company is a license for Company to use the same in the performance of Services.

6. **Relationship.** (a) Nothing herein creates a partnership, agency or joint venture between the Parties. (b) The failure to require strict observance or performance of any provision of these Conditions shall not be construed to be a waiver of a Party's right to later require strict observance and performance of the same. If any provision of these Conditions is held to be invalid or unenforceable, such invalidity shall not invalidate the remainder of the Conditions. (c) For a period of two years after the commencement of this Agreement, Client shall not directly or indirectly try to solicit for employment any of Company's employees.

7. **INDEMNITY.** CLIENT SHALL HOLD HARMLESS AND INDEMNIFY COMPANY, ITS AFFILIATES AND THEIR RESPECTIVE DIRECTORS, OFFICERS, EMPLOYEES, AGENTS AND SUBCONTRACTORS AGAINST ALL THIRD-PARTY CLAIMS FOR LOSS, DAMAGE, INJURY, DEATH OR EXPENSE OF WHATEVER NATURE, INCLUDING BUT NOT LIMITED TO CLAIMS ARISING FROM OR RELATING TO (i) THE PERFORMANCE OF ANY SERVICES BY COMPANY, (ii) THE SALE, RESALE, MANUFACTURE, DISTRIBUTION OR USE OF ANY OF CLIENT'S GOODS OR (iii) BREACH OF CLIENT'S OBLIGATIONS OR WARRANTIES HEREIN.

8. **LIMITATIONS OF LIABILITY.** (A) COMPANY SHALL NOT BE LIABLE FOR ANY INDIRECT, CONSEQUENTIAL OR SPECIAL LOSS IN CONNECTION WITH THE REPORT, THE PRODUCT FOR WHICH SERVICES WERE PERFORMED, OR THE SERVICES PROVIDED BY COMPANY HEREUNDER. COMPANY SHALL NOT BE LIABLE FOR ANY LOSS OR DAMAGE WHATSOEVER RESULTING FROM ANY DELAY IN THE PERFORMANCE OF ITS OBLIGATIONS HEREUNDER OR FROM THE FAILURE OF COMPANY TO PROVIDE ITS SERVICES WITHIN ANY TIME PERIOD FOR COMPLETION ESTIMATED BY COMPANY, REGARDLESS OF THE CAUSE OF THE DELAY OR FAILURE. (B) THE ENTIRE FINANCIAL AND LEGAL LIABILITY OF COMPANY IN RESPECT OF ANY CLAIM FOR LOSS, INDEMNITY, CONTRIBUTION OR DAMAGE OF WHATEVER NATURE OR HOWSOEVER ARISING, SHALL NOT EXCEED AN AMOUNT EQUAL TO FIVE (5) TIMES THE AMOUNT OF FEES PAID TO COMPANY FOR THE SPECIFIC SERVICES WHICH GAVE RISE TO SUCH CLAIM.

9. **Force Majeure.** If any event of force majeure or any event outside the control of Company occurs, Company may immediately cancel or suspend its performance hereunder without incurring any liability whatsoever to Client.

10. **Governing Law.** These Conditions shall be governed by the laws of the country as follows: for Services performed in (i) the Americas, the laws of New York; (ii) Asia Pacific, South Asia, Middle East and Africa, the laws of Hong Kong (except for China where PRC laws govern); and (iii) Europe, the laws of England.

11. **Dispute Resolution.** (a) If Client desires to assert a claim relating to the Services, it must submit the same to Company in writing setting forth with particularity the basis for such claim within 90 days from discovery of the claim and not more than six months after the date of issuance of the Report. Client waives any and all claims without limitation that it does not submit within such time periods. (b) If a dispute arises under this Agreement, the Parties shall first attempt good faith negotiations, failing which, the Parties (i) agree that the courts of the country of governing law shall have exclusive jurisdiction to settle any such dispute related to this Agreement and (ii) irrevocably waive their right to trial by jury in any such action or proceeding.

12. These Conditions, the applicable order form and/or quotation and the Report represent the entire understanding of the Parties on the subject matter hereof, and no modification is binding unless in writing. Any of Client's terms and conditions attached to, enclosed with or referred to in any order form, purchase order or other document shall not apply.

Gen v.1 copyright 2015 Bureau Veritas

END OF THE REPORT.

**Report No:**

**(7418)144-0214F(SL)**

**Jul 14, 2018**

**Page 1 of 4**

**Applicant:** Water Solutions (Pvt) Ltd.

**Address :** Ma Fas Eri, 1<sup>st</sup> Floor,  
Ameenee Magu,  
Male,  
Maldives.

**Attn:** Mr. Aslam Mohamed/ Mr. Abdulla Fazeel

**Sample Received as:** 500ml x 2 No.s of water sample contained in sealed plastic bottles submitted by the client.

**Sample Described by the Client as:** Thilafushi SW6  
Date & time Sampled : 03/07/2018 at 07.15 a.m

**Date of Sample Received:** Jul 06, 2018  
**Date of Testing Started:** Jul 06, 2018  
**Date of Testing Completed:** Jul 13, 2018  
**Date of Report Issued:** Jul 14, 2018

**Photo of the Submitted Sample**



**The content of this PDF file is in accordance with the original issued reports for reference only.  
This Test Report cannot be reproduced, except in full, without prior written permission of the company.**

## CPS CONDITIONS OF SERVICE

The party that submits a completed service request form to Company or signs a quotation issued by the Company for its performance of services ("**Services**") is the "**Client**" under these Conditions of Service. The entity within the Bureau Veritas Consumer Products Services division accepting the service request form and issuing the Report documenting the results of those Services is the "**Company**" under these Conditions of Service. Company and Client are, together, the "**Parties**" and each is a "**Party**". A request for Services constitutes a legally binding agreement on both Parties when such a request is accepted by the Company ("**Agreement**") under the following terms and conditions (collectively, "**Conditions**"):

**1. Services.** (a) The completion of the Services shall be evidenced by the Company's issuing to Client a written report setting forth the results of the Services based upon the properly accepted request, applicable protocols, written information, and where applicable, the product sample provided by Client to Company ("**Report**"). Company may delegate/assign the performance of all or a portion of the Services to an affiliate of Company or to an agent or subcontractor. Client shall provide to Company on a timely basis, all documents and information necessary to enable Company to properly perform the Services. Company may, in its sole discretion, dispose of product samples furnished to Company for the Services that were not destroyed in the course of performance of the Services. (b) Client represents and warrants to Company that (i) each product sample is not submitted in violation of a third party's intellectual property rights; (ii) Client will not use and rely upon Company's Report for any product whose properties differ from the sample(s) upon which the Report is based; and (iii) any goods subject to inspection will be completely prepared for the type of inspection booked for the specified date, and (c) Client accepts sole responsibility and liability for the accuracy of documents submitted to government or other regulatory bodies, including certificates of compliance required under the US Consumer Product Safety Improvement Act and EU requirements under REACH regulations. Client's responsibility and liability for accuracy shall apply even where Company has provided assistance to Client in preparation of such documentation.

**2. Report.** (a) The Report shall (i) constitute the sole deliverable for the Services, (ii) relate solely to the facts and circumstances as observed and recorded by Company at the time of performance of the Services within the limits of written information and instructions received from Client; Company shall have no obligation to update the Report after its issuance. Where the Services include testing or inspection: (i) the Report will set forth the findings of Company solely with respect to the product samples identified therein and (ii) the results set forth in the Report are not to be construed as indicative or representative of the quality or characteristics of the lot from which a product sample was taken for Company's performance of Services. (b) The Report is issued solely by Company, is intended for the exclusive use of Client and its affiliates and, except as required by a regulatory body, shall not be published, used for advertising purposes, copied or replicated for distribution or publicly disclosed without Company's prior written consent. Company is not responsible for any third party's interpretation of the Report. (c) Client shall not request a Report for purposes of litigation, nor shall it list Company, its affiliates or employees as an expert in any proceeding without Company's prior written consent. If Client anticipates producing or otherwise using the Report in any legal proceedings, it shall so notify Company prior to submitting the Report in such proceeding.

**3. Representations and Warranties.** (a) Company undertakes due care and ordinary skill in the performance of its Services. (b) Client agrees that Company is neither an insurer nor a guarantor and does not take the place of Client or the third parties that it retains, including designers, manufacturers, agents, buyers, distributors, and transportation or shipping companies; Company disclaims all liability in such capacities. Client understands that, if it seeks to protect itself from claims of loss, damage or injury, it should obtain appropriate insurance. (c) Company does not warrant or guarantee Client's products, and Company's Report does not represent a warranty of merchantability, a warranty of fitness for a particular purpose, or any other warranty or guarantee.

**4. Payment.** Payment in full shall be due 30 days after the date of invoice, failing which Company may revoke any credit extended to Client. Client shall reimburse Company for (i) interest on overdue amounts from the due date until paid at an interest rate of 1.5% per month and (ii) any other costs Company incurs in collecting past due amounts, including court, attorneys and collection agencies' fees.

**5. Intellectual Property.** The names, service marks, trademarks and copyrights of Company and its affiliates (collectively, the "**Marks**") are and remain the sole property of Company and shall not be used by Client. Client shall not contest the validity of the Marks or take any action that might impair the value or goodwill associated with the Marks or the image or reputation of Company or its affiliates. Client understands that any information or samples submitted to Company is a license for Company to use the same in the performance of Services.

**6. Relationship.** (a) Nothing herein creates a partnership, agency or joint venture between the Parties. (b) The failure to require strict observance or performance of any provision of these Conditions shall not be construed to be a waiver of a Party's right to later require strict observance and performance of the same. If any provision of these Conditions is held to be invalid or unenforceable, such invalidity shall not invalidate the remainder of the Conditions. (c) For a period of two years after the commencement of this Agreement, Client shall not directly or indirectly try to solicit for employment any of Company's employees.

**7. INDEMNITY.** CLIENT SHALL HOLD HARMLESS AND INDEMNIFY COMPANY, ITS AFFILIATES, AND THEIR RESPECTIVE DIRECTORS, OFFICERS, EMPLOYEES, AGENTS AND SUBCONTRACTORS AGAINST ALL THIRD-PARTY CLAIMS FOR LOSS, DAMAGE, INJURY, DEATH, OR EXPENSE OF WHATEVER NATURE, INCLUDING BUT NOT LIMITED TO CLAIMS ARISING FROM OR RELATING TO (I) THE PERFORMANCE OF ANY SERVICES BY COMPANY, (II) THE SALE, RESALE, MANUFACTURE, DISTRIBUTION OR USE OF ANY OF CLIENT'S GOODS OR (III) BREACH OF CLIENT'S OBLIGATIONS OR WARRANTIES HEREIN.

**8. LIMITATIONS OF LIABILITY.** (A) COMPANY SHALL NOT BE LIABLE FOR ANY INDIRECT, CONSEQUENTIAL OR SPECIAL LOSS IN CONNECTION WITH THE REPORT, THE PRODUCT FOR WHICH SERVICES WERE PERFORMED, OR THE SERVICES PROVIDED BY COMPANY HEREUNDER. COMPANY SHALL NOT BE LIABLE FOR ANY LOSS OR DAMAGE WHATSOEVER RESULTING FROM ANY DELAY IN THE PERFORMANCE OF ITS OBLIGATIONS HEREUNDER OR FROM THE FAILURE OF COMPANY TO PROVIDE ITS SERVICES WITHIN ANY TIME PERIOD FOR COMPLETION ESTIMATED BY COMPANY, REGARDLESS OF THE CAUSE OF THE DELAY OR FAILURE. (B) THE ENTIRE FINANCIAL AND LEGAL LIABILITY OF COMPANY IN RESPECT OF ANY CLAIM FOR LOSS, INDEMNITY, CONTRIBUTION OR DAMAGE OF WHATEVER NATURE OR HOWSOEVER ARISING, SHALL NOT EXCEED AN AMOUNT EQUAL TO FIVE (5) TIMES THE AMOUNT OF FEES PAID TO COMPANY FOR THE SPECIFIC SERVICES WHICH GAVE RISE TO SUCH CLAIM.

**9. Force Majeure.** If any event of force majeure or any event outside the control of Company occurs, Company may immediately cancel or suspend its performance hereunder without incurring any liability whatsoever to Client.

**10. Governing Law.** These Conditions shall be governed by the laws of the country as follows: for Services performed in (i) the Americas: the laws of New York, (ii) Asia Pacific, South Asia, Middle East and Africa: the laws of Hong Kong (except for China where PRC laws govern), and (iii) Europe: the laws of England.

**11. Dispute Resolution.** (a) If Client desires to assert a claim relating to the Services, it must submit the same to Company in writing setting forth with particularity the basis for such claim within 90 days from discovery of the claim and not more than six months after the date of issuance of the Report. Client waives any and all claims without limitation that it does not submit within such time periods. (b) If a dispute arises under this Agreement, the Parties shall first attempt good faith negotiations, failing which, the Parties (i) agree that the courts of the country of governing law shall have exclusive jurisdiction to settle any such dispute related to this Agreement and (ii) irrevocably waive their right to trial by jury in any such action or proceeding.

**12.** These Conditions, the applicable order form and/or quotation and the Report represent the entire understanding of the Parties on the subject matter hereof, and no modification is binding unless in writing. Any of Client's terms and conditions attached to, enclosed with or referred to in any order form, purchase order or other document shall not apply.



# TEST REPORT

Report No:

(7418)144-0214F(SL)

Jul 14, 2018

Page 2 of 4

## TEST RESULTS

No.	Parameters	Results	LOQ	Unit	Test Method
1	Temperature at Receiving	24.2	-	°C	APHA 20th Edition – 2550B
2	Turbidity	0.2	-	NTU	APHA 2130 B
3	pH at 24°C*	8.4	-	-	FD-MTHD-007:2013 Reference to APHA 4500H+
4	Nitrate (as NO <sub>3</sub> <sup>-</sup> )	0.3	-	mg/l	APHA 4500 -NO <sub>3</sub> - E
5	Oil & Grease*	<2.0	2.0	mg/l	FD-MTHD-032:2013 Reference to APHA 5520B
6	Free Ammonia (as NH <sub>3</sub> )	0.05	-	mg/l	SLS 614: Appendix A: 2013
7	Salinity	37	-	ppt	APHA 2520
<b>Heavy Metals</b>					
8	Arsenic (as As)*	ND	0.001	mg/l	CPSD-AN-00581-MTHD with ICP-MS
9	Cadmium (as Cd)*	ND	0.0001	mg/l	
10	Lead (as Pb)*	ND	0.001	mg/l	
11	Mercury (as Hg)*	ND	0.00005	mg/l	
12	Nickel (as Ni)*	ND	0.001	mg/l	
13	Copper (as Cu)*	ND	0.001	mg/l	
14	Zinc (as Zn)*	0.003	-	mg/l	
15	Chromium (as Cr)	ND	0.001	mg/l	





# TEST REPORT

Report No: (7418)144-0214F(SL)

Jul 14, 2018

Page 3 of 4

**Remark –**

**\*ISO 17025 :2005 ACCREDITED TEST BY SRI LANKA ACCREDITATION BOARD FOR CONFORMITY ASSESSMENT (SLAB)**

**NOTE:**

mg/l: milligrams per liter, ppt: parts per thousand,  
APHA: American Public Health Association  
ND: Not Detected, LOQ: Limit of Quantification,  
NTU: Nephelometric Turbidity Units, °C : Celcius,  
ICP-MS: Inductively Coupled Plasma – Mass Spectroscopy.


**Contact information for this report (Technical and General Inquiries and Feedback)**

GENERAL INQUIRIES:		
IROSHA UDUGAMPALA	TEL: +94 768 229 528	E-MAIL: Irosha.Udugampala@lk.bureauveritas.com
TECHNICAL INQUIRIES:		
INDRAJITH HATHURUSINGHA	TEL: + 94 769 603 814	E-MAIL: Indrajith.hs@lk.bureauveritas.com
FEED BACK:		
DHANUKA PERERA –EXECUTIVE QHSE	TEL: +94 768 229 479	E-MAIL: dhanuka.perera@lk.bureauveritas.com

REVIEWED BY: SHYAMIKA WICKRAMASINGHE

BUREAU VERITAS CONSUMER PRODUCTS SERVICES LANKA (PVT) LTD.

AUTHORIZED SIGNATORY

APPROVED BY:   
INDRAJITH HATHURUSINGHA  
MANAGER -  
FOOD LABORATORY



# TEST REPORT

Report No:

(7418)144-0214F(SL)

Jul 14, 2018

Page 4 of 4

## CPS CONDITIONS OF SERVICE

The party that submits a completed service request form to Company or signs a quotation issued by the Company for its performance of services ("Services") is the "Client" under these Conditions of Service. The entity within the Bureau Veritas Consumer Products Services division accepting the service request form and issuing the Report documenting the results of those Services is the "Company" under these Conditions of Service. Company and Client are, together, the "Parties" and each is a "Party". A request for Services constitutes a legally binding agreement on both Parties when such a request is accepted by the Company ("Agreement") under the following terms and conditions (collectively, "Conditions").

**1. Services.** (a) The completion of the Services shall be evidenced by the Company's issuing to Client a written report setting forth the results of the Services based upon the properly accepted request, applicable protocols, written information, and where applicable, the product sample provided by Client to Company ("Report"). Company may delegate/assign the performance of all or a portion of the Services to an affiliate of Company or to an agent or subcontractor. Client shall provide to Company on a timely basis, all documents and information necessary to enable Company to properly perform the Services. Company may, in its sole discretion, dispose of product samples furnished to Company for the Services that were not destroyed in the course of performance of the Services. (b) Client represents and warrants to Company that (i) each product sample is not submitted in violation of a third party's intellectual property rights, (ii) Client will not use and rely upon Company's Report for any product whose properties differ from the samples upon which the Report is based, and (iii) any goods subject to inspection will be completely prepared for the type of inspection booked for the specified date, and (c) Client accepts sole responsibility and liability for the accuracy of documents submitted to government or other regulatory bodies, including certificates of compliance required under the US Consumer Product Safety Improvement Act and EU requirements under REACH regulations. Client's responsibility and liability for accuracy shall apply even where Company has provided assistance to Client in preparation of such documentation.

**2. Report.** (a) The Report shall (i) constitute the sole deliverable for the Services, (ii) relate solely to the facts and circumstances as observed and recorded by Company at the time of performance of the Services within the limits of written information and instructions received from Client, Company shall have no obligation to update the Report after its issuance. Where the Services include testing or inspection (i) the Report will set forth the findings of Company solely with respect to the product samples identified therein and (ii) the results set forth in the Report are not to be construed as indicative or representative of the quality or characteristics of the lot from which a product sample was taken for Company's performance of Services. (b) The Report is issued solely by Company, is intended for the exclusive use of Client and its affiliates and, except as required by a regulatory body, shall not be published, used for advertising purposes, copied or replicated for distribution or publicly disclosed without Company's prior written consent. Company is not responsible for any third party's interpretation of the Report. (c) Client shall not request a Report for purposes of litigation, nor shall it list Company, its affiliates or employees as an expert in any proceeding without Company's prior written consent. If Client anticipates producing or otherwise using the Report in any legal proceedings, it shall so notify Company prior to submitting the Report in such proceeding.

**3. Representations and Warranties.** (a) Company undertakes due care and ordinary skill in the performance of its Services. (b) Client agrees that Company is neither an insurer nor a guarantor and does not take the place of Client or the third parties that it retains, including designers, manufacturers, agents, buyers, distributors, and transportation or shipping companies. Company disclaims all liability in such capacities. Client understands that if it seeks to protect itself from claims of loss, damage or injury, it should obtain appropriate insurance. (c) Company does not warrant or guarantee Client's products, and Company's Report does not represent a warranty of merchantability, a warranty of fitness for a particular purpose, or any other warranty or guarantee.

**4. Payment.** Payment in full shall be due 30 days after the date of invoice, failing which Company may revoke any credit extended to Client. Client shall reimburse Company for (i) interest on overdue amounts from the due date until paid at an interest rate of 1.5% per month and (ii) any other costs Company incurs in collecting past due amounts, including court, attorneys and collection agencies fees.

**5. Intellectual Property.** The names, service marks, trademarks and copyrights of Company and its affiliates (collectively, the "Marks") are and remain the sole property of Company and shall not be used by Client. Client shall not contest the validity of the Marks or take any action that might impair the value or goodwill associated with the Marks or the image or reputation of Company or its affiliates. Client understands that any information or samples submitted to Company is a license for Company to use the same in the performance of Services.

**6. Relationship.** (a) Nothing herein creates a partnership, agency or joint venture between the Parties. (b) The failure to require strict observance or performance of any provision of these Conditions shall not be construed to be a waiver of a Party's right to later require strict observance and performance of the same. If any provision of these Conditions is held to be invalid or unenforceable, such invalidity shall not invalidate the remainder of the Conditions. (c) For a period of two years after the commencement of this Agreement, Client shall not directly or indirectly try to solicit for employment any of Company's employees.

**7. INDEMNITY.** CLIENT SHALL HOLD HARMLESS AND INDEMNIFY COMPANY, ITS AFFILIATES, AND THEIR RESPECTIVE DIRECTORS, OFFICERS, EMPLOYEES, AGENTS AND SUBCONTRACTORS AGAINST ALL THIRD-PARTY CLAIMS FOR LOSS, DAMAGE, INJURY, DEATH OR EXPENSE OF WHATEVER NATURE, INCLUDING BUT NOT LIMITED TO CLAIMS ARISING FROM OR RELATING TO (i) THE PERFORMANCE OF ANY SERVICES BY COMPANY, (ii) THE SALE, RESALE, MANUFACTURE, DISTRIBUTION OR USE OF ANY OF CLIENT'S GOODS OR (iii) BREACH OF CLIENT'S OBLIGATIONS OR WARRANTIES HEREIN.

**8. LIMITATIONS OF LIABILITY.** (A) COMPANY SHALL NOT BE LIABLE FOR ANY INDIRECT, CONSEQUENTIAL OR SPECIAL LOSS IN CONNECTION WITH THE REPORT, THE PRODUCT FOR WHICH SERVICES WERE PERFORMED, OR THE SERVICES PROVIDED BY COMPANY HEREUNDER. COMPANY SHALL NOT BE LIABLE FOR ANY LOSS OR DAMAGE WHATSOEVER RESULTING FROM ANY DELAY IN THE PERFORMANCE OF ITS OBLIGATIONS HEREUNDER OR FROM THE FAILURE OF COMPANY TO PROVIDE ITS SERVICES WITHIN ANY TIME PERIOD FOR COMPLETION ESTIMATED BY COMPANY, REGARDLESS OF THE CAUSE OF THE DELAY OR FAILURE. (B) THE ENTIRE FINANCIAL AND LEGAL LIABILITY OF COMPANY IN RESPECT OF ANY CLAIM FOR LOSS, INDEMNITY, CONTRIBUTION OR DAMAGE OF WHATEVER NATURE OR HOWSOEVER ARISING, SHALL NOT EXCEED AN AMOUNT EQUAL TO FIVE (5) TIMES THE AMOUNT OF FEES PAID TO COMPANY FOR THE SPECIFIC SERVICES WHICH GAVE RISE TO SUCH CLAIM.

**9. Force Majeure.** If any event of force majeure or any event outside the control of Company occurs, Company may immediately cancel or suspend its performance hereunder without incurring any liability whatsoever to Client.

**10. Governing Law.** These Conditions shall be governed by the laws of the country as follows: for Services performed in (i) the Americas, the laws of New York; (ii) Asia Pacific, South Asia, Middle East and Africa, the laws of Hong Kong (except for China where PRC laws govern); and (iii) Europe, the laws of England.

**11. Dispute Resolution.** (a) If Client desires to assert a claim relating to the Services, it must submit the same to Company in writing setting forth with particularity the basis for such claim within 90 days from discovery of the claim and not more than six months after the date of issuance of the Report. Client waives any and all claims, without limitation that it does not submit within such time periods. (b) If a dispute arises under this Agreement, the Parties shall first attempt good faith negotiations, failing which, the Parties (i) agree that the courts of the country of governing law shall have exclusive jurisdiction to settle any such dispute related to this Agreement and (ii) irrevocably waive their right to trial by jury in any such action or proceeding.

**12. These Conditions, the applicable order form and/or quotation and the Report represent the entire understanding of the Parties on the subject matter hereof, and no modification is binding unless in writing. Any of Client's terms and conditions attached to, enclosed with or referred to in any order form, purchase order or other document shall not apply.**

Gen v 1 copyright 2015 Bureau Veritas

**END OF THE REPORT.**

**Report No:**

**(7418)144-0214G(SL)**

Jul 14, 2018

Page 1 of 4

**Applicant:** Water Solutions (Pvt) Ltd.

**Address :** Ma Fas Eri, 1<sup>st</sup> Floor,  
Ameenee Magu,  
Male,  
Maldives.

**Attn:** Mr. Aslam Mohamed/ Mr. Abdulla Fazeel

**Sample Received as:** 500ml x 2 No.s of water sample contained in sealed plastic bottles submitted by the client.

**Sample Described by the Client as:** Thilafushi SW7  
Date & time Sampled : 03/07/2018 at 08.45 a.m

**Date of Sample Received:** Jul 06, 2018

**Date of Testing Started:** Jul 06, 2018

**Date of Testing Completed:** Jul 13, 2018

**Date of Report Issued:** Jul 14, 2018

**Photo of the Submitted Sample**



**The content of this PDF file is in accordance with the original issued reports for reference only.  
This Test Report cannot be reproduced, except in full, without prior written permission of the company.**

**Bureau Veritas Consumer Products Services Lanka (Pvt) Ltd.**

No. 570, Galle Road, Katubedda, Sri Lanka.

Tel : (9411) 2350111 Fax : (9411) 2622198 / 9

E-mail : bvpcs.lanka@lk.bureauveritas.com

This report is governed by, and incorporates by reference, the Conditions of Testing as posted at the date of issuance of this report at <http://www.mil-acts.com> and is intended for your exclusive use. Any copying or replication of this report to or for any other person or entity, or use of our name or trademark, is permitted only with our prior written permission. This report sets forth our findings solely with respect to the test samples identified herein. The results set forth in this report are not indicative or representative of the quality or characteristics of the lot from which a test sample was taken or any similar or identical product unless specifically and expressly noted. Our report includes all of the tests requested by you and the results thereof based upon the information that you provided to us. You have 60 days from date of issuance of this report to notify us of any material error or omission caused by our negligence, provided, however, that such notice shall be in writing and shall specifically address the issue you wish to raise. A failure to raise such issue within the prescribed time shall constitute your unqualified acceptance of the completeness of this report, the tests conducted and the correctness of the report contents.

## CPS CONDITIONS OF SERVICE

The party that submits a completed service request form to Company or signs a quotation issued by the Company for its performance of services ("**Services**") is the "**Client**" under these Conditions of Service. The entity within the Bureau Veritas Consumer Products Services division accepting the service request form and issuing the Report documenting the results of those Services is the "**Company**" under these Conditions of Service. Company and Client are, together, the "**Parties**" and each is a "**Party**". A request for Services constitutes a legally binding agreement on both Parties when such a request is accepted by the Company ("**Agreement**") under the following terms and conditions (collectively, "**Conditions**"):

**1. Services.** (a) The completion of the Services shall be evidenced by the Company's issuing to Client a written report setting forth the results of the Services based upon the properly accepted request, applicable protocols, written information, and where applicable, the product sample provided by Client to Company ("**Report**"). Company may delegate/assign the performance of all or a portion of the Services to an affiliate of Company or to an agent or subcontractor. Client shall provide to Company on a timely basis, all documents and information necessary to enable Company to properly perform the Services. Company may, in its sole discretion, dispose of product samples furnished to Company for the Services that were not destroyed in the course of performance of the Services. (b) Client represents and warrants to Company that (i) each product sample is not submitted in violation of a third party's intellectual property rights; (ii) Client will not use and rely upon Company's Report for any product whose properties differ from the sample(s) upon which the Report is based; and (iii) any goods subject to inspection will be completely prepared for the type of inspection booked for the specified date, and (c) Client accepts sole responsibility and liability for the accuracy of documents submitted to government or other regulatory bodies, including certificates of compliance required under the US Consumer Product Safety Improvement Act and EU requirements under REACH regulations. Client's responsibility and liability for accuracy shall apply even where Company has provided assistance to Client in preparation of such documentation.

**2. Report.** (a) The Report shall (i) constitute the sole deliverable for the Services, (ii) relate solely to the facts and circumstances as observed and recorded by Company at the time of performance of the Services within the limits of written information and instructions received from Client; Company shall have no obligation to update the Report after its issuance. Where the Services include testing or inspection: (i) the Report will set forth the findings of Company solely with respect to the product samples identified therein and (ii) the results set forth in the Report are not to be construed as indicative or representative of the quality or characteristics of the lot from which a product sample was taken for Company's performance of Services. (b) The Report is issued solely by Company, is intended for the exclusive use of Client and its affiliates and, except as required by a regulatory body, shall not be published, used for advertising purposes, copied or replicated for distribution or publicly disclosed without Company's prior written consent. Company is not responsible for any third party's interpretation of the Report. (c) Client shall not request a Report for purposes of litigation, nor shall it list Company, its affiliates or employees as an expert in any proceeding without Company's prior written consent. If Client anticipates producing or otherwise using the Report in any legal proceedings, it shall so notify Company prior to submitting the Report in such proceeding.

**3. Representations and Warranties.** (a) Company undertakes due care and ordinary skill in the performance of its Services. (b) Client agrees that Company is neither an insurer nor a guarantor and does not take the place of Client or the third parties that it retains, including designers, manufacturers, agents, buyers, distributors, and transportation or shipping companies; Company disclaims all liability in such capacities. Client understands that, if it seeks to protect itself from claims of loss, damage or injury, it should obtain appropriate insurance. (c) Company does not warrant or guarantee Client's products, and Company's Report does not represent a warranty of merchantability, a warranty of fitness for a particular purpose, or any other warranty or guarantee.

**4. Payment.** Payment in full shall be due 30 days after the date of invoice, failing which Company may revoke any credit extended to Client. Client shall reimburse Company for (i) interest on overdue amounts from the due date until paid at an interest rate of 1.5% per month and (ii) any other costs Company incurs in collecting past due amounts, including court, attorneys and collection agencies' fees.

**5. Intellectual Property.** The names, service marks, trademarks and copyrights of Company and its affiliates (collectively, the "**Marks**") are and remain the sole property of Company and shall not be used by Client. Client shall not contest the validity of the Marks or take any action that might impair the value or goodwill associated with the Marks or the image or reputation of Company or its affiliates. Client understands that any information or samples submitted to Company is a license for Company to use the same in the performance of Services.

**6. Relationship.** (a) Nothing herein creates a partnership, agency or joint venture between the Parties. (b) The failure to require strict observance or performance of any provision of these Conditions shall not be construed to be a waiver of a Party's right to later require strict observance and performance of the same. If any provision of these Conditions is held to be invalid or unenforceable, such invalidity shall not invalidate the remainder of the Conditions. (c) For a period of two years after the commencement of this Agreement, Client shall not directly or indirectly try to solicit for employment any of Company's employees.

**7. INDEMNITY.** CLIENT SHALL HOLD HARMLESS AND INDEMNIFY COMPANY, ITS AFFILIATES, AND THEIR RESPECTIVE DIRECTORS, OFFICERS, EMPLOYEES, AGENTS AND SUBCONTRACTORS AGAINST ALL THIRD-PARTY CLAIMS FOR LOSS, DAMAGE, INJURY, DEATH, OR EXPENSE OF WHATEVER NATURE, INCLUDING BUT NOT LIMITED TO CLAIMS ARISING FROM OR RELATING TO (I) THE PERFORMANCE OF ANY SERVICES BY COMPANY, (II) THE SALE, RESALE, MANUFACTURE, DISTRIBUTION OR USE OF ANY OF CLIENT'S GOODS OR (III) BREACH OF CLIENT'S OBLIGATIONS OR WARRANTIES HEREIN.

**8. LIMITATIONS OF LIABILITY.** (A) COMPANY SHALL NOT BE LIABLE FOR ANY INDIRECT, CONSEQUENTIAL OR SPECIAL LOSS IN CONNECTION WITH THE REPORT, THE PRODUCT FOR WHICH SERVICES WERE PERFORMED, OR THE SERVICES PROVIDED BY COMPANY HEREUNDER. COMPANY SHALL NOT BE LIABLE FOR ANY LOSS OR DAMAGE WHATSOEVER RESULTING FROM ANY DELAY IN THE PERFORMANCE OF ITS OBLIGATIONS HEREUNDER OR FROM THE FAILURE OF COMPANY TO PROVIDE ITS SERVICES WITHIN ANY TIME PERIOD FOR COMPLETION ESTIMATED BY COMPANY, REGARDLESS OF THE CAUSE OF THE DELAY OR FAILURE. (B) THE ENTIRE FINANCIAL AND LEGAL LIABILITY OF COMPANY IN RESPECT OF ANY CLAIM FOR LOSS, INDEMNITY, CONTRIBUTION OR DAMAGE OF WHATEVER NATURE OR HOWSOEVER ARISING, SHALL NOT EXCEED AN AMOUNT EQUAL TO FIVE (5) TIMES THE AMOUNT OF FEES PAID TO COMPANY FOR THE SPECIFIC SERVICES WHICH GAVE RISE TO SUCH CLAIM.

**9. Force Majeure.** If any event of force majeure or any event outside the control of Company occurs, Company may immediately cancel or suspend its performance hereunder without incurring any liability whatsoever to Client.

**10. Governing Law.** These Conditions shall be governed by the laws of the country as follows: for Services performed in (i) the Americas: the laws of New York, (ii) Asia Pacific, South Asia, Middle East and Africa: the laws of Hong Kong (except for China where PRC laws govern), and (iii) Europe: the laws of England.

**11. Dispute Resolution.** (a) If Client desires to assert a claim relating to the Services, it must submit the same to Company in writing setting forth with particularity the basis for such claim within 90 days from discovery of the claim and not more than six months after the date of issuance of the Report. Client waives any and all claims without limitation that it does not submit within such time periods. (b) If a dispute arises under this Agreement, the Parties shall first attempt good faith negotiations, failing which, the Parties (i) agree that the courts of the country of governing law shall have exclusive jurisdiction to settle any such dispute related to this Agreement and (ii) irrevocably waive their right to trial by jury in any such action or proceeding.

**12.** These Conditions, the applicable order form and/or quotation and the Report represent the entire understanding of the Parties on the subject matter hereof, and no modification is binding unless in writing. Any of Client's terms and conditions attached to, enclosed with or referred to in any order form, purchase order or other document shall not apply.



# TEST REPORT

Report No:

(7418)144-0214G(SL)

Jul 14, 2018

Page 2 of 4

## TEST RESULTS

No.	Parameters	Results	LOQ	Unit	Test Method
1	Temperature at Receiving	24.2	-	°C	APHA 20th Edition -- 2550B
2	Turbidity	0.2	-	NTU	APHA 2130 B
3	pH at 24°C*	8.2	-	-	FD-MTHD-007:2013 Reference to APHA 4500H+
4	Nitrate (as NO <sub>3</sub> <sup>-</sup> )	0.5	-	mg/l	APHA 4500 -NO <sub>3</sub> - E
5	Oil & Grease*	<2.0	2.0	mg/l	FD-MTHD-032:2013 Reference to APHA 5520B
6	Free Ammonia (as NH <sub>3</sub> )	<0.02	0.02	mg/l	SLS 614 Appendix A: 2013
7	Salinity	36	-	ppt	APHA 2520
<b>Heavy Metals</b>					
8	Arsenic (as As)*	ND	0.001	mg/l	CPSD-AN-00581-MTHD with ICP-MS
9	Cadmium (as Cd)*	ND	0.0001	mg/l	
10	Lead (as Pb)*	ND	0.001	mg/l	
11	Mercury (as Hg)*	ND	0.00005	mg/l	
12	Nickel (as Ni)*	ND	0.001	mg/l	
13	Copper (as Cu)*	ND	0.001	mg/l	
14	Zinc (as Zn)*	0.008	-	mg/l	
15	Chromium (as Cr)	ND	0.001	mg/l	



# TEST REPORT

Report No: (7418)144-0214G(SL)

Jul 14, 2018

Page 3 of 4

**Remark –**

**\*ISO 17025 :2005 ACCREDITED TEST BY SRI LANKA ACCREDITATION BOARD FOR CONFORMITY ASSESSMENT (SLAB)**

**NOTE:**

mg/l: milligrams per liter, ppt: parts per thousand,  
APHA: American Public Health Association  
ND: Not Detected, LOQ: Limit of Quantification,  
NTU: Nephelometric Turbidity Units, °C : Celcius,  
ICP-MS: Inductively Coupled Plasma – Mass Spectroscopy.

**Contact information for this report (Technical and General Inquiries and Feedback)**

GENERAL INQUIRIES:		
IROSHA UDUGAMPALA	TEL: +94 768 229 528	E-MAIL: irosha.Udugampala@lk.bureauveritas.com
TECHNICAL INQUIRIES:		
INDRAJITH HATHURUSINGHA	TEL: + 94 769 603 814	E-MAIL: Indrajith.hs@lk.bureauveritas.com
FEED BACK:		
DHANUKA PERERA –EXECUTIVE QHSE	TEL: +94 768 229 479	E-MAIL: dhanuka.perera@lk.bureauveritas.com

REVIEWED BY: SHYAMIKA WICKRAMASINGHE

BUREAU VERITAS CONSUMER PRODUCTS SERVICES LANKA (PVT) LTD.

AUTHORIZED SIGNATORY

APPROVED BY: for   
INDRAJITH HATHURUSINGHA  
MANAGER -  
FOOD LABORATORY



# TEST REPORT

Report No:

(7418)144-0214G(SL)

Jul 14, 2018

Page 4 of 4

## CPS CONDITIONS OF SERVICE

The party that submits a completed service request form to Company or signs a quotation issued by the Company for its performance of services ("Services") is the "Client" under these Conditions of Service. The entity within the Bureau Veritas Consumer Products Services division accepting the service request form and issuing the Report documenting the results of those Services is the "Company" under these Conditions of Service. Company and Client are, together, the "Parties" and each is a "Party". A request for Services constitutes a legally binding agreement on both Parties when such a request is accepted by the Company ("Agreement") under the following terms and conditions (collectively "Conditions").

**1. Services.** (a) The completion of the Services shall be evidenced by the Company's issuing to Client a written report setting forth the results of the Services based upon the properly accepted request, applicable protocols, written information, and where applicable, the product sample provided by Client to Company ("Report"). Company may delegate/assign the performance of all or a portion of the Services to an affiliate of Company or to an agent or subcontractor. Client shall provide to Company on a timely basis, all documents and information necessary to enable Company to properly perform the Services. Company may, in its sole discretion, dispose of product samples furnished to Company for the Services that were not destroyed in the course of performance of the Services. (b) Client represents and warrants to Company that (i) each product sample is not submitted in violation of a third party's intellectual property rights, (ii) Client will not use and rely upon Company's Report for any product whose properties differ from the samples upon which the Report is based, and (iii) any goods subject to inspection will be completely prepared for the type of inspection booked for the specified date, and (c) Client accepts sole responsibility and liability for the accuracy of documents submitted to government or other regulatory bodies, including certificates of compliance required under the US Consumer Product Safety Improvement Act and EU requirements under REACH regulations. Client's responsibility and liability for accuracy shall apply even where Company has provided assistance to Client in preparation of such documentation.

**2. Report.** (a) The Report shall (i) constitute the sole deliverable for the Services, (ii) relate solely to the facts and circumstances as observed and recorded by Company at the time of performance of the Services within the limits of written information and instructions received from Client. Company shall have no obligation to update the Report after its issuance. Where the Services include testing or inspection, (iii) the Report will set forth the findings of Company solely with respect to the product samples identified therein and (iv) the results set forth in the Report are not to be construed as indicative or representative of the quality or characteristics of the lot from which a product sample was taken for Company's performance of Services. (b) The Report is issued solely by Company, is intended for the exclusive use of Client and its affiliates and, except as required by a regulatory body, shall not be published, used for advertising purposes, copied or replicated for distribution or publicly disclosed without Company's prior written consent. Company is not responsible for any third party's interpretation of the Report. (c) Client shall not request a Report for purposes of litigation, nor shall it list Company, its affiliates or employees as an expert in any proceeding without Company's prior written consent. If Client anticipates procuring or otherwise using the Report in any legal proceedings, it shall so notify Company prior to submitting the Report in such proceeding.

**3. Representations and Warranties.** (a) Company undertakes due care and ordinary skill in the performance of its Services. (b) Client agrees that Company is neither an insurer nor a guarantor and does not take the place of Client or the third parties that it retains, including designers, manufacturers, agents, buyers, distributors, and transportation or shipping companies. Company disclaims all liability in such capacities. Client understands that, if it seeks to protect itself from claims of loss, damage or injury, it should obtain appropriate insurance. (c) Company does not warrant or guarantee Client's products, and Company's Report does not represent a warranty of merchantability, a warranty of fitness for a particular purpose, or any other warranty or guarantee.

**4. Payment.** Payment in full shall be due 30 days after the date of invoice, failing which Company may revoke any credit extended to Client. Client shall reimburse Company for (i) interest on overdue amounts from the due date until paid at an interest rate of 1.5% per month and (ii) any other costs Company incurs in collecting past due amounts, including court, attorneys and collection agencies' fees.

**5. Intellectual Property.** The names, service marks, trademarks and copyrights of Company and its affiliates (collectively the "Marks") are and remain the sole property of Company and shall not be used by Client. Client shall not contest the validity of the Marks or take any action that might impair the value or goodwill associated with the Marks or the image or reputation of Company or its affiliates. Client understands that any information or samples submitted to Company is a license for Company to use the same in the performance of Services.

**6. Relationship.** (a) Nothing herein creates a partnership, agency or joint venture between the Parties. (b) The failure to require strict observance or performance of any provision of these Conditions shall not be construed to be a waiver of a Party's right to later require strict observance and performance of the same. If any provision of these Conditions is held to be invalid or unenforceable, such invalidity shall not invalidate the remainder of the Conditions. (c) For a period of two years after the commencement of this Agreement, Client shall not directly or indirectly try to solicit for employment any of Company's employees.

**7. INDEMNITY.** CLIENT SHALL HOLD HARMLESS AND INDEMNIFY COMPANY, ITS AFFILIATES, AND THEIR RESPECTIVE DIRECTORS, OFFICERS, EMPLOYEES, AGENTS AND SUBCONTRACTORS AGAINST ALL THIRD-PARTY CLAIMS FOR LOSS, DAMAGE, INJURY, DEATH OR EXPENSE OF WHATEVER NATURE, INCLUDING BUT NOT LIMITED TO CLAIMS ARISING FROM OR RELATING TO (i) THE PERFORMANCE OF ANY SERVICES BY COMPANY, (ii) THE SALE, RESALE, MANUFACTURE, DISTRIBUTION OR USE OF ANY OF CLIENT'S GOODS OR (iii) BREACH OF CLIENT'S OBLIGATIONS OR WARRANTIES HEREIN.

**8. LIMITATIONS OF LIABILITY.** (A) COMPANY SHALL NOT BE LIABLE FOR ANY INDIRECT, CONSEQUENTIAL OR SPECIAL LOSS IN CONNECTION WITH THE REPORT, THE PRODUCT FOR WHICH SERVICES WERE PERFORMED OR THE SERVICES PROVIDED BY COMPANY HEREUNDER. COMPANY SHALL NOT BE LIABLE FOR ANY LOSS OR DAMAGE WHATSOEVER RESULTING FROM ANY DELAY IN THE PERFORMANCE OF ITS OBLIGATIONS HEREUNDER OR FROM THE FAILURE OF COMPANY TO PROVIDE ITS SERVICES WITHIN ANY TIME PERIOD FOR COMPLETION ESTIMATED BY COMPANY, REGARDLESS OF THE CAUSE OF THE DELAY OR FAILURE. (B) THE ENTIRE FINANCIAL AND LEGAL LIABILITY OF COMPANY IN RESPECT OF ANY CLAIM FOR LOSS, INDEMNITY, CONTRIBUTION OR DAMAGE OF WHATEVER NATURE OR HOWSOEVER ARISING, SHALL NOT EXCEED AN AMOUNT EQUAL TO FIVE (5) TIMES THE AMOUNT OF FEES PAID TO COMPANY FOR THE SPECIFIC SERVICES WHICH GAVE RISE TO SUCH CLAIM.

**9. Force Majeure.** If any event of force majeure or any event outside the control of Company occurs, Company may immediately cancel or suspend its performance hereunder without incurring any liability whatsoever to Client.

**10. Governing Law.** These Conditions shall be governed by the laws of the country as follows: for Services performed in (i) the Americas, the laws of New York; (ii) Asia Pacific, South Asia, Middle East and Africa, the laws of Hong Kong (except for China where PRC laws govern); and (iii) Europe, the laws of England.

**11. Dispute Resolution.** (a) If Client desires to assert a claim relating to the Services, it must submit the same to Company in writing setting forth with particularity the basis for such claim within 90 days from discovery of the claim and not more than six months after the date of issuance of the Report. Client waives any and all claims without limitation that it does not submit within such time periods. (b) If a dispute arises under this Agreement, the Parties shall first attempt good faith negotiations, failing which, the Parties (i) agree that the courts of the country of governing law shall have exclusive jurisdiction to settle any such dispute related to this Agreement and (ii) irrevocably waive their right to trial by jury in any such action or proceeding.

**12.** These Conditions, the applicable order form and/or quotation and the Report represent the entire understanding of the Parties on the subject matter hereof and no modification is binding unless in writing. Any of Client's terms and conditions attached to, enclosed with or referred to in any order form, purchase order or other document shall not apply.

Gen v 1 copyright 2015 Bureau Veritas

END OF THE REPORT.

Environmental Impact Assessment for the Waste-to-Energy Plant Project in Thilafushi  
**Biodiversity and Critical Habitat Assessment**



**Prepared by:** Aleef Naseem and Abdul Aleem (EIA P03/2019)



25<sup>th</sup> November 2019



---

## Contents

I.	Introduction .....	3
II.	Definition of Critical Habitat .....	3
III.	Areas of analysis.....	4
IV.	Thresholds of Critical Habitat .....	5
V.	Critical Habitat Screening and Assessment.....	5
VI.	Criteria 1 – 3: Critically Endangered or Endangered Species, Endemic and/or Restricted-range species Migratory or Congregatory Species .....	5
VII.	Criterion 4: Unique assemblages of species that are associated with key evolutionary processes.....	12
VIII.	Criterion 5: Areas having biodiversity of significant social, economic, or cultural importance to local communities (including ecosystem services) .....	12
IX.	Legally protected areas and international recognized areas.....	13
X.	Conclusion and Recommendations .....	13

---

## I. Introduction

1. The ADB Safeguard Policy Statement (ADB 2009) requires assessment of whether the project is planned in an area that may qualify as Critical Habitat or Natural Habitat. This assessment followed more detailed guidance in International Finance Corporation Performance Standard 6 and its recently updated accompanying guidance note (IFC 2012, 2019).
2. ADB SPS requires that any projects financed by ADB shall not implement project activities and components in area of critical habitat/s, unless (i) there are no measurable adverse impacts on the critical habitat that could impair its ability to function, (ii) there is no reduction in the population of any recognized endangered or critically endangered species, and (iii) any lesser impacts are mitigated. If a project is located within a legally protected area, ADB requires that the project implement additional programs to promote and enhance the conservation aims of the protected area. In an area of natural habitats, there must be no significant conversion or degradation, unless (i) alternatives are not available, (ii) the overall benefits from the project substantially outweigh the environmental costs, and (iii) any conversion or degradation is appropriately mitigated. ADB SPS further requires the use of precautionary approach in the use, development, and management of renewable natural resources.
3. In order to assess whether the Greater Malé Waste-to-Energy Project (WTE project) is located in a critical habitat, an initial screening was undertaken using the Integrated Biodiversity Assessment Tool (IBAT).<sup>1</sup> Results show that the location of the WTE project is likely a critical habitat. Therefore, a critical habitat assessment is needed to confirm the results.
4. This biodiversity and critical habitat assessment is applicable to the WTE project. Apart from the information from the IBAT screening, this report is also based on the baseline information provided in the EIA for the WTE project, which was supported with literature review and field data collection.

## II. Definition of Critical Habitat

5. Critical habitat is defined in ADB SPS (2009) as a subset of both natural and modified habitat that deserves particular attention. Critical habitat includes areas with high biodiversity value, including (i) habitat required for the survival of critically endangered or endangered species; (ii) areas having special significance for endemic or restricted-range species; (iii) sites that are critical for the survival of migratory species; (iv) areas supporting globally significant concentrations or numbers of individuals of congregatory species; (v) areas with unique assemblages of species or that are associated with key evolutionary processes or provide key ecosystem services; and (vi) areas having biodiversity of significant social, economic, or cultural importance to local communities.

---

<sup>1</sup> The Integrated Biodiversity Assessment Tool (IBAT) is a multi-institutional programme of work involving BirdLife International, Conservation International, IUCN, and UNEP-WCMC. IBAT provides a basic risk screening on biodiversity. It draws together information on globally recognised biodiversity information drawn from a number of IUCN's Knowledge Products: IUCN Red List of Threatened Species, Key Biodiversity Areas (priority sites for conservation) and Protected Planet/The World Database on Protected Areas (covering nationally and internationally recognised sites, including IUCN management categories I–VI, Ramsar Wetlands of International Importance and World Heritage sites).

### III. Areas of analysis

6. Critical Habitat and Natural Habitat assessment ideally takes place across sensible ecological or political units that are sufficiently large to encompass all direct and indirect impacts from the project. These areas of analysis (AoAs) are thus often much broader than the direct project footprint. AoAs may be separate or combined, depending on the ecology of the biodiversity concerned.

7. Considering the extent of potential impacts on aquatic biodiversity from the Project an aquatic AoA was identified as the 50-km study area to make consistent with the default range in the IBAT Screening. This area is approximately within the Zone 3 of Maldives, within which common biological communities and/or management issues exist (Figure 1).

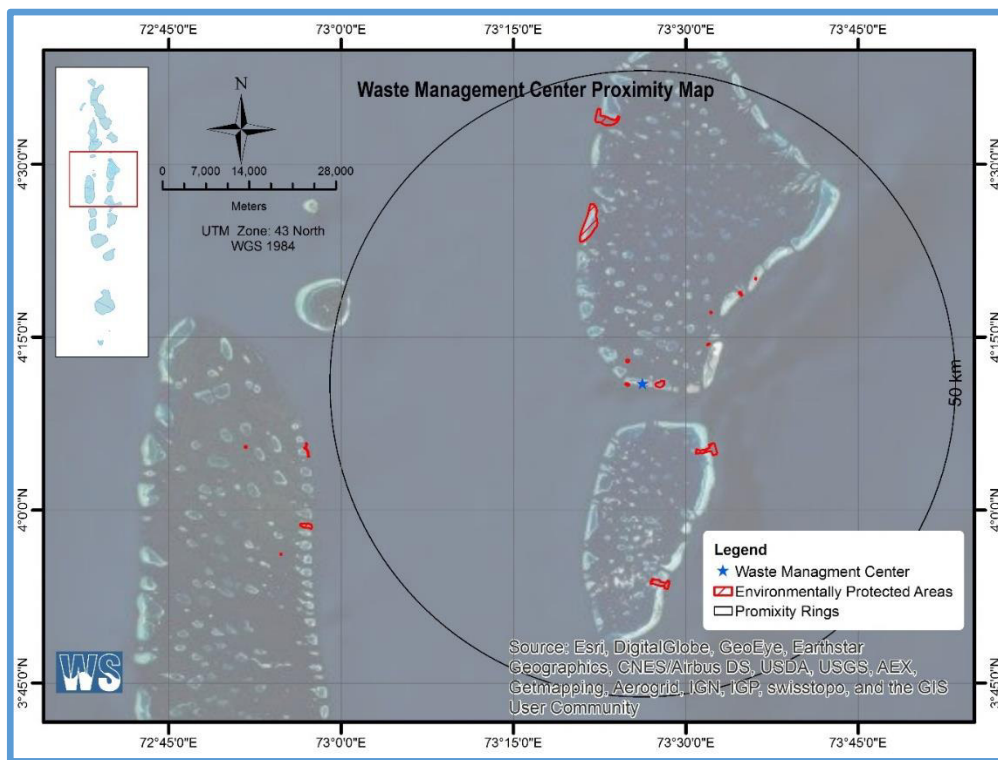


Figure 1: 50km buffer zone from project site at Thilafushi

8. Identification of AoAs does not mean that the project has any obligations across them. The aim of this Critical Habitat Assessment is to identify whether the broad units qualify as Critical Habitat and, if so, for which biodiversity features. This information helps to prioritize impact assessment and to focus mitigation efforts.

---

#### IV. Thresholds of Critical Habitat

1. To identify if a certain species can qualify the project AoA as Critical Habitat, the IFC Guidance Note 6 (2019)<sup>2</sup> has been used.

#### V. Critical Habitat Screening and Assessment

2. Critical habitat screening considered critical habitat-qualifying biodiversity candidates identified within the EIA as actually or potentially present. In each case, reasons are identified for each biodiversity feature likely meeting or not meeting Critical Habitat. IBAT was used as the initial screening for critical habitat values. Performance Standard 6 (PS6) defines these values for critical habitat (PS6: para. 16) and legally protected and internationally recognized areas (PS6: para. 20). The IBAT was used to screen for known risks within a standard 50km buffer of the project area at Thilafushi (see **Error! Reference source not found.**).

#### VI. Criteria 1 – 3: Critically Endangered or Endangered Species, Endemic and/or Restricted-range species Migratory or Congregatory Species

3. Habitat of significant importance to priority species can trigger critical habitat status. IBAT was used to create a preliminary list of priority species that could occur within the AoA. This list is drawn from the IUCN Red List of Threatened Species (IUCN RL). Due to the uncertainty surrounding the assessment at this preliminary stage, the list of species for which Critical Habitat may be triggered is still provisional and will require further analysis as reiterated in the conclusion.

4. The justification for the assessment has been provided in Table 1.

5. It should be noted that this list is preliminary and other species not currently included or poorly represented such as birds, fish, and invertebrates may come to light and require inclusion following monitoring and field surveys, continued desk study, and stakeholder engagement during project implementation.

---

<sup>2</sup> [https://www.ifc.org/wps/wcm/connect/5e0f3c0c-0aa4-4290-a0f8-4490b61de245/GN6\\_English\\_June-27-2019.pdf?MOD=AJPERES&CVID=mRQjZva](https://www.ifc.org/wps/wcm/connect/5e0f3c0c-0aa4-4290-a0f8-4490b61de245/GN6_English_June-27-2019.pdf?MOD=AJPERES&CVID=mRQjZva)

Table 1: Critical Habitat Screening Assessment

Species Name	Criteria 1 CR or EN Species	Criteria 2 Endemic / Restricted Range Species	Criteria 3 Migratory Congregatory Species	Rationale
<b>Mammals</b>				
Blue Whale <i>Balaenoptera musculus</i>	EN	-	M	About 5,000 individuals of this species survive today in three populations: North Atlantic, North Pacific, and the Southern Hemisphere. According to interviews with local people, there has been only few sightings of Blue Whales in Maldives waters and is regarded as an uncommon visitor to the Maldives. There is no recorded information that can confirm the regular occurrence of this species in the AoA. It is very unlikely that the Project AoA holds >0.5% of the global population of this species, and >5 pairs, at least seasonally. <i>Balaenoptera musculus</i> does not appear to qualify the Project area as Critical Habitat.
<b>Birds</b>				
Matsudaira's Storm-petrel <i>Oceanodroma matsudairae</i>	-	RS	M	Population is only known to breed on the Volcano Islands in southern Japan. After breeding the species move south across equatorial belt and then winters in the equatorial belt. Only recorded in Ha. Atoll (Anderson & Baldock 2001), which is not within the AoA. There is a possibility that the species could occur near the coast in the Project AoA. This is, however, unlikely given degradation and development in that area. Based on the available information, <10% of the species' range overlap the terrestrial AoA, and there is low likelihood that suitable habitat exists in the Project area. <i>Oceanodroma matsudairae</i> does not appear to qualify the Project area as Critical Habitat.

Species Name	Criteria 1 CR or EN Species	Criteria 2 Endemic / Restricted Range Species	Criteria 3 Migratory / Congregatory Species	Rationale
<b>Odonata</b>				
<i>Enallagma maldivense</i>	CR	RS	-	<i>Enallagma maldivensis</i> is a species of damselfly. There is insufficient data available for this species. No data is available on its population size in the AoA nor population size for the entire country. Dragonflies normally are found in freshwater habitats. No information is available on the presence of freshwater habitats (e.g. ponds) in the AoA. On a precautionary basis, it is possible that the terrestrial AoA holds more than 0.5% of the global population of this globally Critically Endangered damselfly. <b>As such, <i>Enallagma maldivense</i> qualifies the project AoA as Critical Habitat.</b>
<b>Fishes</b>				
Pondicherry Shark <i>Carcharhinus hemiodon</i>	CR	-	-	The Pondicherry Shark is a rare shark found on the continental and insular shelves of the eastern Indian Ocean and the western Pacific, from India to New Guinea. Thought to be extinct, recently found near a seasonal fishing village in Sri Lanka. There have been no recorded sightings in Maldives. It is very unlikely that the Project AoA holds >0.5% of the global population of this species, and >5 pairs. <i>Carcharhinus hemiodon</i> does not appear to qualify the Project area as Critical Habitat.
Bowmouth Guitar shark <i>Rhina ancylostoma</i>	VU*	-	-	Although this shark is found throughout coastal areas across the Indian Ocean, sightings of this species in Maldives is rare. There is no recorded information that can confirm the regular occurrence of this species in the AoA. There is no reason to suspect that the AoA holds disproportionately high or low populations. The Project only occupies a small percentage of the AoA and is not predicted to have broad-scale impacts. Without further information, it thus seems unlikely that the Project could have impacts on this shark that would impact it to a level that it would become Endangered. As such, <i>Rhina ancylostoma</i> does not qualify the Project area as Critical Habitat.

Species Name	Criteria 1 CR or EN Species	Criteria 2 Endemic / Restricted Range Species	Criteria 3 Migratory Congregatory Species	Rationale
Bottlenose Wedge shark <i>Rhynchobatus australiae</i>	CR	-	-	<p>The Bottlenose Wedgefish inhabits inshore waters on the continental shelves, specifically enclosed bays, estuaries, and coral reefs. It is found in South-East Asia and Australia.</p> <p>Although this shark is also found throughout coastal areas across the Indian Ocean, sightings of this species in Maldives is rare. There is no recorded information that can confirm the regular occurrence of this species in the AoA. It is very unlikely that the Project AoA holds &gt;0.5% of the global population of this species, and &gt;5 pairs. <i>Rhynchobatus australiae</i> does not appear to qualify the Project area as Critical Habitat.</p>
Whale Shark <i>Rhincodon typus</i>	EN	-	-	<p>Whale sharks are commonly found within Maldives. A possible resident population exists in ADh. Atoll which is outside the AoA. Sightings are rare within the AoA. It is very unlikely that the Project AoA holds &gt;0.5% of the global population of this species, and &gt;5 pairs. <i>Rhincodon typus</i> does not appear to qualify the Project area as Critical Habitat.</p>
Shortfin Mako Shark <i>Isurus oxyrinchus</i>	EN	-	M	<p>The Shortfin Mako is an offshore littoral and epipelagic species found occurring in tropical and warm-temperate waters of all oceans. It is a highly migratory species making extensive journeys of over 3,000 kilometers. This species is found throughout Maldives. However, occurrence close to the atolls is very rare. There is no recorded information that can confirm the regular occurrence of this species in the AoA, It is very unlikely that the Project AoA holds &gt;0.5% of the global population of this species, and &gt;5 pairs. <i>Isurus oxyrinchus</i> does not appear to qualify the Project area as Critical Habitat.</p>

Species Name	Criteria 1 CR or EN Species	Criteria 2 Endemic / Restricted Range Species	Criteria 3 Migratory Congregatory Species	Rationale
Great Hammerhead <i>Sphyrna mokarran</i>	EN	-	-	<i>Sphyrna mokarran</i> is a coastal-pelagic and semi-oceanic tropical hammerhead occurring close inshore and well offshore, over the continental shelves, island terraces, and in passes and lagoons of coral atolls, as well as over deep water near land. Sightings are seasonal during the start of North-east Monsoon. According to diver community, southern atolls have the most likelihood of sightings which fall outside the AoA. The great hammerhead ranges widely throughout the tropical waters of the world. For this reason, it is very unlikely that the Project AoA holds >0.5% of the global population of this species, and >5 pairs. <i>Sphyrna mokarran</i> does not appear to qualify the Project area as Critical Habitat.
Ornate Eagle Ray <i>Aetomylaeus vespertilio</i>	EN	-	-	The Ornate Eagle Ray has a sporadic distribution in the Indo-West Pacific, including Maldives. It occurs on the inner continental shelf to depths of 110 m over soft sandy substrate. Rarely seen and one sighting at Landaa Giraavaru, Baa Atoll, Maldives was recorded on February 2018. This area is outside the AoA. It is very unlikely that the Project AoA holds >0.5% of the global population of this species, and >5 pairs. <i>Aetomylaeus vespertilio</i> does not appear to qualify the Project area as Critical Habitat.
Longfin Mako <i>Isurus paucus</i>	EN	-	-	The Longfin Mako is widespread in tropical and warm temperate waters, and likely occurs in all oceans, although its distribution is poorly recorded. Sightings of this species in Maldives is rare. It is very unlikely that the Project AoA holds >0.5% of the global population of this species, and >5 pairs. <i>Isurus paucus</i> does not appear to qualify the Project area as Critical Habitat.



Species Name	Criteria 1 CR or EN Species	Criteria 2 Endemic / Restricted Range Species	Criteria 3 Migratory / Congregatory Species	Rationale
Sky Emperor <i>Lethrinus mahsena</i>	EN	-	-	This species is found in coral reef habitats and adjacent sandy and seagrass areas. Commercially fished in most of its habitat, but there are no evidences that it happens in the Maldives as well. It is very unlikely that the Project AoA holds >0.5% of the global population of this species, and >5 pairs. <i>Lethrinus mahsena</i> does not appear to qualify the Project area as Critical Habitat.
<b>Echinoderms</b>				
Golden Sandfish <i>Holothuria scabra</i> ; Golden Sandfish <i>Holothuria lesson</i> ; Black Teatfish <i>Holothuria nobilis</i>	EN	-	-	All these holothurian species are fished commercially, with some local populations in sharp decline due to overexploitation. All three species have a wide range across Indo-Pacific tropical seas. No information is available about the presence and abundance of these species in the project AoA; however, it is very unlikely that the Project AoA holds >0.5% of the global population of this species, and >5 pairs. <i>Holothuria spp.</i> do not appear to qualify the Project area as Critical Habitat.
<b>Corals</b>				
<i>Acropora rudis</i>	EN	-	-	This species is found in the northern Indian Ocean and the central Indo-Pacific. Found also in the Maldives, however, data lacks on population size. The AoA is already impacted and not all the reefs are in pristine conditions, and this species was also not found during the underwater surveys. It is extremely unlikely the Project AoA holds >0.5% of the global population of this species. <i>Acropora rudis</i> does not appear to qualify the Project area as Critical Habitat.

CR – Critically Endangered under IUCN Red List; EN – Endangered under the IUCN Red List; RS – Restricted Range Species under IUCN; M – migratory.

\*- Recently changed to vulnerable status in IUCN Red List



## VII. Criterion 4: Unique assemblages of species that are associated with key evolutionary processes

6. As is the case for the majority of Indo-Pacific islands, the Maldives Archipelago has been subject to long and extreme isolation that has allowed evolutionary processes to generate unique, endemic flora and fauna. Beyond this general context, however, there is no reason to believe that the terrestrial or aquatic AoA host particularly unusual or key evolutionary processes. Unique assemblages of species associated with key evolutionary processes thus do not qualify the Project area as Critical Habitat.

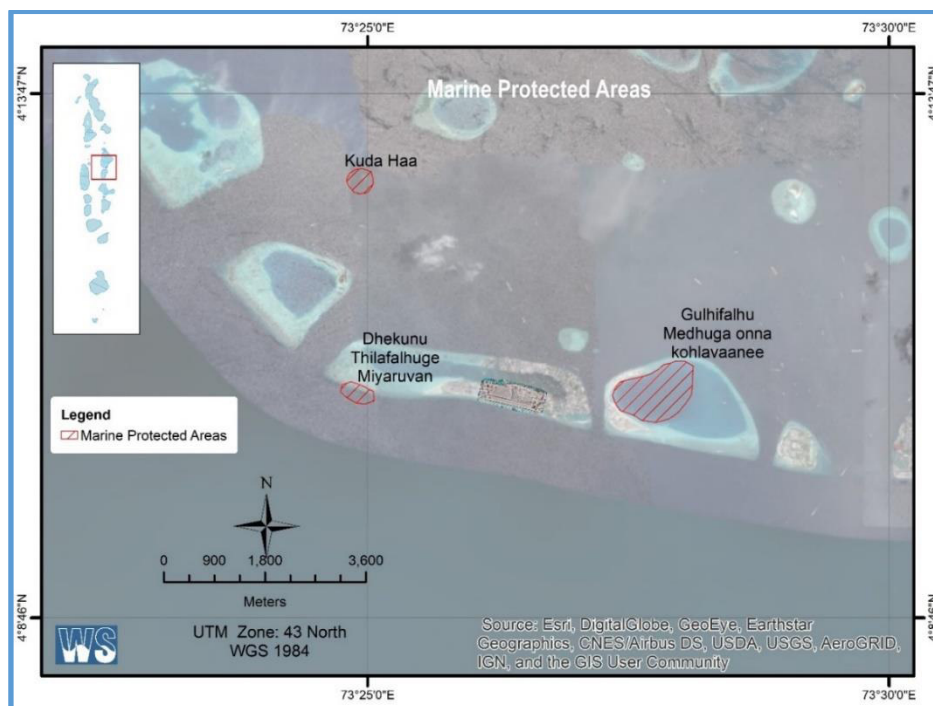
## VIII. Criterion 5: Areas having biodiversity of significant social, economic, or cultural importance to local communities (including ecosystem services)

7. This additional assessment considers the ecosystem services from biodiversity in general. The assessment of significance of ecosystem services to local communities is assessed retrospectively in line with the consultation with local dive communities.

8. Ecosystem services affected by the project are prioritized when all three of the following criteria are met: (i) the project might affect the ability of others to benefit from the service; (ii) the affected service is important to beneficiaries' well-being; and (iii) beneficiaries do not have viable alternatives for that service.

9. The limited information presented does not give reason to believe that the Project terrestrial or aquatic AoA are sufficiently important to local people that they represent Critical Habitat under this criterion. However, it is beyond the scope of this assessment to collect additional information on ecosystem services, and then to assess which may qualify the project area as Critical Habitat.

**Figure 2. 5km buffer zone from project site at Thilafushi**



---

## **IX. Legally protected areas and internationally recognized areas**

10. There are some areas near to the Project. The nearest MPA to the WTE project site is the “*Lions Head*” (Dhekunu Thilafalhuge Miyaruvani), around 1 km from the proposed plant. Additionally, as a precautionary approach, a more focused habitat assessment was conducted for this MPA. Results show that none of the IUCN species categorized as critically endangered species, endangered species or vulnerable species is found within this MPA. Results also show that none of nationally protected species is found within this MPA either. A complete assessment of the Lions Head is attached as Annex 2.

24. Following IFC (2019), none of the protected areas found in the Project AoA meets the thresholds for Critical Habitat for some species for which it was designated. For this reason, none of the protected areas found in the AoA qualify the Project area as Critical Habitat.

## **X. Conclusion and Recommendations**

25. The WTE project will be established in Maldives, a country rich in biodiversity. Based on the initial screening using IBAT, the project site is likely to be a critical habitat at least for a terrestrial insect.

11. In the course of project implementation, it is highly recommended that continuous marine underwater monitoring be undertaken around Thilfushi island to confirm the extent of biodiversity in various seasons of the year, including assessment of features pertinent to critical habitats. In cases when future information determines the existence of critical habitat within the study area, the WTE project should be able to demonstrate that:

- (i) It does not lead to measurable adverse impacts on those biodiversity values for which the critical habitat was designated, and on the ecological processes supporting those biodiversity values;
- (ii) It does not lead to a net reduction in the global and/or national/regional population of any Critically Endangered or Endangered species over a reasonable period of time; and
- (iii) It has integrated into its management program a robust, appropriately designed, and long-term biodiversity monitoring and evaluation program.

---

## REFERENCES

- Aeby, G., Lovell, E., Richards, Z., Delbeek, J.C., Reboton, C. & Bass, D. 2008. *Acropora rudis*. The IUCN Red List of Threatened Species 2008: e.T132913A3490569. <http://dx.doi.org/10.2305/IUCN.UK.2008.RLTS.T132913A3490569.en>. Downloaded on 27 November 2019.
- Al Abdali, F.S.H., Al Buwaiqi, B., Al Kindi, A.S.M., Ambuali, A., Borsa, P., Govender, A. & Russell, B. 2019. *Lethrinus mahsena*. The IUCN Red List of Threatened Species 2019: e.T16720057A16722325. <http://dx.doi.org/10.2305/IUCN.UK.2019-2.RLTS.T16720057A16722325.en>. Downloaded on 27 November 2019.
- Anderson, C. and Bladock, M. (2001). New records of birds from the Maldives, with notes on other species. *Forktail*, 17, pp.67–73.
- BirdLife International (2019) Species factsheet: *Hydrobates matsudairae*. Downloaded from <http://www.birdlife.org> on 27/11/2019
- Compagno, L.J.V., White, W. & Fowler, S. (SSG Australia & Oceania Regional Workshop, March 2003) 2003. *Carcharhinus hemiodon*. The IUCN Red List of Threatened Species 2003: e.T39369A10185838. <http://dx.doi.org/10.2305/IUCN.UK.2003.RLTS.T39369A10185838.en>. Downloaded on 27 November 2019.
- Conand, C., Purcell, S. & Gamboa, R. 2013. *Holothuria lessoni*. The IUCN Red List of Threatened Species 2013: e.T180275A1609567. <http://dx.doi.org/10.2305/IUCN.UK.2013-1.RLTS.T180275A1609567.en>. Downloaded on 27 November 2019.
- Dow, R.A. 2009. *Enallagma maldivensis*. The IUCN Red List of Threatened Species 2009: e.T59716A11994224. <http://dx.doi.org/10.2305/IUCN.UK.2009-2.RLTS.T59716A11994224.en>. Downloaded on 27 November 2019.
- Denham, J., Stevens, J.D., Simpfendorfer, C., Heupel, M.R., Cliff, G., Morgan, A., Graham, R., Ducrocq, M., Dulvy, N.K., Seisay, M., Asber, M., Valenti, S.V., Litvinov, F., Martins, P., Lemine Ould Sidi, M., Tous, P. & Bucal, D. 2007. *Sphyrna mokarran*. The IUCN Red List of Threatened Species 2007: e.T39386A10191938. <http://dx.doi.org/10.2305/IUCN.UK.2007.RLTS.T39386A10191938.en>. Downloaded on 27 November 2019.
- Khadheeja Ali & Hussain Sinan, 2015. National Plan of Action for the Conservation and Management of Sharks. Ministry of Fisheries and agriculture.
- Kyne, P.M., Rigby, C.L., Dharmadi & Jabado, R.W. 2019. *Rhynchobatus australiae*. The IUCN Red List of Threatened Species 2019: e.T41853A68643043. <http://dx.doi.org/10.2305/IUCN.UK.2019-2.RLTS.T41853A68643043.en>. Downloaded on 27 November 2019.
- McAuley, R.B., Compagno, L.J.V. & Chin, A. 2016. *Rhina ancylostoma*. The IUCN Red List of Threatened Species 2016: e.T41848A68641634. <http://dx.doi.org/10.2305/IUCN.UK.2016-1.RLTS.T41848A68641634.en>. Downloaded on 27 November 2019.
- Nyawira Muthiga, 2018. Field observations of sea cucumbers at North Male Atoll in the Maldives. SPC Beche de Mer Information Bulletin #27 – March 2008
- Pierce, S.J. & Norman, B. 2016. *Rhincodon typus*. The IUCN Red List of Threatened Species 2016: e.T19488A2365291. <http://dx.doi.org/10.2305/IUCN.UK.2016-1.RLTS.T19488A2365291.en>. Downloaded on 27 November 2019.
- Rigby, C.L., Barreto, R., Carlson, J., Fernando, D., Fordham, S., Francis, M.P., Jabado, R.W., Liu, K.M., Marshall, A., Pacoureau, N., Romanov, E., Sherley, R.B. & Winker, H. 2019. *Isurus*

---

oxyrinchus. The IUCN Red List of Threatened Species 2019:  
e.T39341A2903170. <http://dx.doi.org/10.2305/IUCN.UK.2019-1.RLTS.T39341A2903170.en>. Downloaded on 27 November 2019.

Riley, M., Hale, M., Harman, A. and Rees, R. (2010). Analysis of whale shark *Rhincodon typus* aggregations near South Ari Atoll, Maldives Archipelago. *Aquatic Biology*, 8, pp.145-150.

---

**Annex 1: IBAT assessment report**



## Integrated Biodiversity Assessment Tool

# WORLD BANK GROUP BIODIVERSITY RISK SCREEN

Report generated on 20/11/2019 by Francesco Ricciardi under the license number 2780-5415 held by ADB. [www.ibat-alliance.org](http://www.ibat-alliance.org)

Project Name: Thlafushi WTE

Location: [ 4.2, 73.4 ]

### Overlaps with:

Protected Areas	11
Key Biodiversity Areas	0
IUCN Red List	15
Critical Habitat	Likely



Displaying project location and buffers: 10.0 km, 50.0 km



This report is based on IFC Performance Standard 6 (PS6) but applies to World Bank Environmental and Social Standard 6 (ESS6)







## About this report

IBAT provides initial screening for critical habitat values. Performance Standard 6 (PS6) defines these values for critical habitat (PS6: para. 16) and legally protected and internationally recognized areas (PS6: para. 20). PS6 will be triggered when IFC client activities are located in modified habitats containing "significant biodiversity value," natural habitats, critical habitats, legally protected areas, or areas that are internationally recognized for biodiversity. References to PS6 and Guidance Note 6 (GN6) are provided to guide further assessment and detailed definitions where necessary. Please see <https://www.ifc.org/ps6> for full details on PS6 and GN6.

The report screens for known risks within a standard 50km buffer of the coordinates used for analysis. This buffer is not intended to indicate the area of impact. The report can be used to:

- Scope risks to include within an assessment of risks and impacts
- Identify gaps within an existing assessment of risks and impacts
- Prioritize between sites in a portfolio for further assessment of risks and impacts
- Inform a preliminary determination of critical habitat
- Assess the need for engaging a biodiversity specialist
- Identify additional conservation experts or organizations to inform further assessment or planning

**WARNING:** IBAT aims to provide the most up-to-date and accurate information available at the time of analysis. There is however a possibility of incomplete, incorrect or out-of-date information. All findings in this report must be supported by further desktop review, consultation with experts and/or on-the-ground field assessment as described in PS6 and GN6. Please consult IBAT for any additional disclaimers or recommendations applicable to the information used to generate this report.

## Legal disclaimer

The Integrated Biodiversity Assessment Tool (IBAT) and IBAT products, which include the IBAT Portal, reports, and data, are owned by IBAT Alliance and accessible by paid subscription.

The IBAT and IBAT products may contain reference to or include content owned and provided by the International Bank for Reconstruction and Development ("IBRD"), the International Development Association ("IDA"), the International Finance Corporation ("IFC"), the Multilateral Investment Guarantee Agency ("MIGA"), and the International Center for Settlement of Investment Disputes ("ICSID") (collectively, the "World Bank Group" or "WBG", individually, the "WBG Member"). The content owned and provided by the WBG Members (the "Member Content") is the respective property of the WBG Member and is protected under general principles of copyright.

The use of Member Content in IBAT and IBAT products is under license and intended for informational purposes only. Such use is not intended to constitute legal, securities, or investment advice, an opinion regarding the appropriateness of any investment, or a solicitation of any type. Additionally, the information is provided on a strictly "as-is" basis, without any assurance or representation of any kind.





The WBG Member does not guarantee the accuracy, reliability or completeness of any Member Content included in IBAT or IBAT products or for the conclusions or judgments described therein. The WBG Member accepts no responsibility or liability for any omissions or errors (including, without limitation, typographical errors and technical errors) in any Member Content whatsoever or for reliance thereon. The boundaries, colors, denominations, and other information shown on any map in IBAT do not imply any judgment on the part of WBG Member concerning the legal status of any territory or the endorsement or acceptance of such boundaries. The findings, interpretations, and conclusions expressed in the IBAT and the IBAT products do not necessarily reflect the views of the WBG Member, its member countries, Executive Directors, or the governments it represents.

The WBG Members are international organizations established under their respective constituent agreement among their member countries. IBRD owns the WBG logos and trademark. The logos and other trademarks, service marks, graphics of a WBG Member are the tradenames, trademarks or registered trademarks of that WBG Member (the "WBG Member Mark"). The WBG logo and trademark and WBG Member Marks may not be copied, imitated, or used, in whole or in part, without the prior written permission of WBG or its Members, as appropriate. All other queries on rights and licenses, including subsidiary rights, should be addressed as follows. If to IFC, to IFC's Corporate Relations Department, 2121 Pennsylvania Avenue, N.W., Washington, D.C. 20433. If to MIGA, to MIGA's Legal Affairs and Claims Group (Attn: Chief Counsel, Operations & Policy), 1818 H Street N.W., U12-1204, Washington, D.C. 20433. If to IBRD and/or IDA, to the Office of the Publisher, The World Bank, 1818 H Street N.W., Washington, D.C. 20433; Email: [pubrights@worldbank.org](mailto:pubrights@worldbank.org).



### Priority Species

Habitat of significant importance to priority species will trigger critical habitat status (See PS6: para 16). IBAT provides a preliminary list of priority species that could occur within the 50km buffer. This list is drawn from the IUCN Red List of Threatened Species (IUCN RL). This list should be used to guide any further assessment, with the aim of confirming known or likely occurrence of these species within the project area. It is also possible that further assessment may confirm occurrence of additional priority species not listed here. It is strongly encouraged that any new species information collected by the project be shared with species experts and/or IUCN wherever possible in order to improve IUCN datasets.

### IUCN Red List of Threatened Species - CR & EN

The following species are potentially found within 50km of the area of interest. For the full IUCN Red List please refer to the associated csv in the report folder.

Species name	Common name	IUCN Category	Group
Carcharhinus hemiodon	Pondicherry Shark	CR	CHONDRICHTHYES
Rhina ancylostoma	Bowmouth Guitarfish	CR	CHONDRICHTHYES
Rhynchobatus australiae	Bottlenose Wedgefish	CR	CHONDRICHTHYES
Enallagma maldivense		CR	INSECTA
Balaenoptera musculus	Blue Whale	EN	MAMMALIA
Rhincodon typus	Whale Shark	EN	CHONDRICHTHYES
Isurus oxyrinchus	Shortfin Mako	EN	CHONDRICHTHYES
Sphyrna mokarran	Great Hammerhead	EN	CHONDRICHTHYES
Aetomylaeus vespertilio	Ornate Eagle Ray	EN	CHONDRICHTHYES
Isurus paucus	Longfin Mako	EN	CHONDRICHTHYES
Acropora rudis		EN	ANTHOZOA



## Biodiversity features which are likely to trigger Critical Habitat

### Protected Areas

The following protected areas are found within 10.0 km and 50.0 km of the area of interest. For further details please refer to the associated csv file in the report folder.

Area name	Distance	Recommendation
Giravaru Kuda Haa	10.0 km	● Assess for biodiversity risk
Hans Hass Plave (Gulhi Falhu)	10.0 km	● Assess for biodiversity risk
Lions Head (Thilafalhu Miyaruvani)	10.0 km	● Assess for biodiversity risk
Banana reef (Gaathu Giri)	50.0 km	● Assess for biodiversity risk
Embudhoo Kanduothi	50.0 km	● Assess for biodiversity risk
Guraidhoo Kandu	50.0 km	● Assess for biodiversity risk
Huraa Mangrove	50.0 km	● Assess for biodiversity risk
Makunudhoo Kandu	50.0 km	● Assess for biodiversity risk
Nassimo Thila (Lankan Thila)	50.0 km	● Assess for biodiversity risk
Rasfari	50.0 km	● Assess for biodiversity risk
Thanburudhoo Thila (HP Reef)	50.0 km	● Assess for biodiversity risk

### Key Biodiversity Areas





The following key biodiversity areas are found within 10.0 km and 50.0 km of the area of interest.  
For further details please refer to the associated csv file in the report folder.

Area name	Distance	Recommendation
-----------	----------	----------------

#### Species with potential to occur

Area Taxonomic group	Total assessed species	Total (CR, EN & VU)	CR	EN	VU	NT	LC	DD
CHONDRICHTHYES	28	19	3	5	11	2	4	3
INSECTA	1	1	1	0	0	0	0	0
MAMMALIA	10	1	0	1	0	0	7	2
ANTHOZOA	124	23	0	1	22	40	53	8
HOLOTHUROIDEA	31	5	0	3	2	0	15	11
ACTINOPTERYGII	656	3	0	1	2	3	628	22
REPTILIA	2	1	0	0	1	0	1	0
AVES	36	2	0	0	2	4	30	0
MAGNOLIOPSIDA	5	0	0	0	0	0	5	0
AMPHIBIA	1	0	0	0	0	0	1	0
HYDROZOA	2	0	0	0	0	0	2	0
MALACOSTRACA	8	0	0	0	0	0	7	1
LILIOPSIDA	3	0	0	0	0	0	3	0





Area Taxonomic group	Total assessed species	Total (CR, EN & VU)	CR	EN	VU	NT	LC	DD
POLYPODIOPSIDA	1	0	0	0	0	0	1	0
GASTROPODA	66	0	0	0	0	0	65	1
BIVALVIA	1	0	0	0	0	0	1	0





Country-level summary

Coming soon





### Recommended Experts and Organizations

For projects located in critical habitat, clients must ensure that external experts with regional expertise are involved in further assessment (GN6: GN22). Clients are encouraged to develop partnerships with recognized and credible conservation organizations and/or academic institutes, especially with respect to potential developments in natural or critical habitat (GN6: GN23). Where critical habitats are triggered by priority species, species specialists must be involved. IBAT provides data originally collected by a large network of national partners, while species information is sourced via the IUCN Red List and affiliated Species Specialist Groups. These experts and organizations are listed below. **Please note that this is not intended as a comprehensive list of organizations and experts. These organizations and experts are under no obligation to support any further assessment and do so entirely at their discretion and under their terms. Any views expressed or recommendations made by these stakeholders should not be attributed to the IFC or IBAT for IFC partners.**

### Relevant national or regional organizations

IBAT integrates information developed by a global network of conservation agencies, organizations and experts. These efforts are coordinated by the IBAT Alliance (BirdLife International, Conservation International, IUCN and UNEP-WCMC) who compile and maintain this information as globally standardized databases. The local partners most relevant to the area of analysis are:

**Wild Bird Society of Japan Address:** Maruwa Building, 3-9-23 Nishi-Gotanda, Shinagawa-ku, Tokyo 141-0031, Japan Web: <http://www.wbsj.org/>

**BirdLife Asia Regional Office Address:** 354 Tanglin Road, #01-16/17, Tanglin International Centre, Singapore 247672  
Email: [singapore.office@birdlife.org](mailto:singapore.office@birdlife.org) Web: <http://www.birdlife.org/asia>

### Directory for Species Survival Commission (SSC) Specialist Groups and Red List Authorities

URL: [http://www.iucn.org/about/work/programmes/species/who\\_we\\_are/ssc\\_specialist\\_groups\\_and\\_red\\_list\\_authorities\\_directory/](http://www.iucn.org/about/work/programmes/species/who_we_are/ssc_specialist_groups_and_red_list_authorities_directory/)





---

**Annex 2: Critical Habitat Assessment for Lions Head MPA**



**LIVE & LEARN**  
MALDIVES

**FINAL REPORT**

Baseline Socio Economic Survey in  
Thilafushi and Gulhifalhu

TA 9327 - Greater Male' Environmental Improvement and Waste Management Project

**August – September 2019**

## Table of Contents

1. Introduction .....	2
2. Methodology .....	2
2.1 Objectives .....	2
2.2 Approach .....	2
2.3 The Sampling Frame and Sampling Strategy .....	3
2.4 Data Collection .....	4
2.4.1 Questionnaire.....	4
2.5 Data Analysis .....	4
2.5.1 Data entry, analysis, synthesis and interpretation.....	4
2.5.2 Integration of Different Information Gathering Processes .....	4
3. Key Findings .....	5
3.1 General Information.....	5
3.2 Income, Expenditure and Savings .....	5
3.4 Health Condition and Healthcare Services .....	7
3.5 Solid Waste Management .....	8
3.6 Other Issues .....	9
4. Limitations .....	10
5. Recommendations .....	10
APPENDICES .....	11
APPENDIX A: List of Tenants Located in Thilafushi.....	11
APPENDIX B: Maps of Thilafushi and Gulhifalhu with the surveyed individuals and companies located.....	22
APPENDIX C: Questionnaires for Individual and Company Surveys .....	23
APPENDIX D: Graphical representation of data obtained from individual survey.....	24
APPENDIX E: Graphical representation of data obtained from company survey .....	44

# **1. Introduction**

Asian Development Bank (ADB) requested and received assistance through the Ministry of Environment and Energy (MEE) for the services of Live and Learn Environment Education to carry out the baseline socio-economic survey of the residents of Thilafushi and Gulhifalhu which was a requirement of the Greater Male' Environmental Improvement and Waste Management Project.

The overall objective of this consultancy was to ascertain baseline socio economic profile of the residents in Thilafushi and Gulhifalhu islands. The survey also aimed to determine the current waste disposal practices, the needs and willingness of the companies operating in the islands to pay for waste management services. The results of the survey will be used for evidence-based planning and designing needs based socially inclusive strategies to maximize project benefits.

This document reports a summary of the purpose, methodology, sampling frame and strategy, data collection and analysis process, key findings of the study, limitations of the study and general recommendations.

## **2. Methodology**

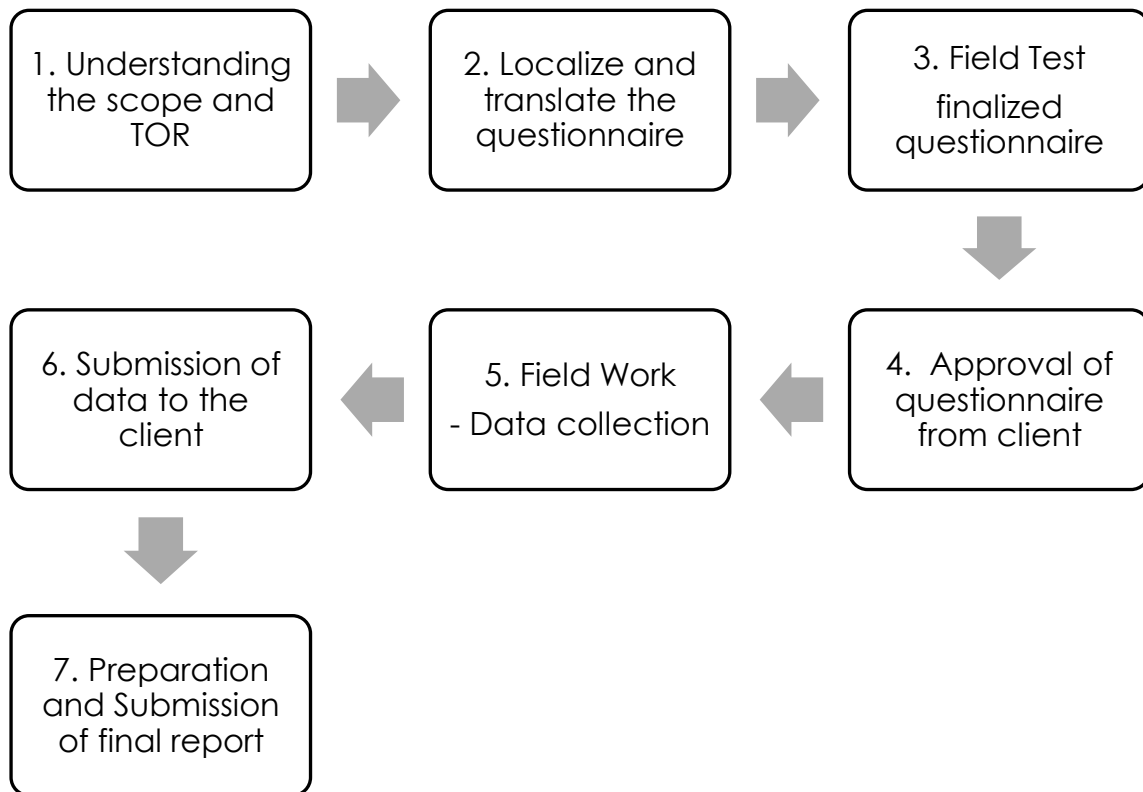
### **2.1 Objectives**

The aim of this study was to ascertain baselines with regards to poverty and development indicators that included a set of socio- economic variables such as, education, occupation, economic status, access to basic services- including access to healthcare, accommodation, clean drinking water and food, and waste management. The survey targeted residents living and/or working in all areas in Thilafushi and Gulhifalhu islands.

### **2.2 Approach**

The following schematic diagram summarizes the key steps of the approach that was followed to carry out the assignment.

**Figure 1: Schematic diagram showing the work methodology**



### **2.3 The Sampling Frame and Sampling Strategy**

The survey was carried out in Thilafushi and Gulhifalhu islands. The survey was based on a core sets of information, an updated list of tenants obtained from Greater Male’ Industrial Zone Limited (GMIZL) and estimated number of workers on site. The survey sample represented a cross-section of the individuals working and/or residing in Thilafushi and Gulhifalhu Islands and the companies based in these two islands.

During the inception phase, Live and Learn identified the survey locations, sampling methodology and sample size. The sample size was based on instructions provided by the client. Specific instructions were provided to survey about 200 individuals living/ and or working in areas or sites that are close in proximity to the waste management site in Thilafushi. Survey locations were finalized with guidance from Thilafushi and Gulhifalhu management office, the Greater Male’ Industrial Zone Limited (GMIZL). According to the information received, not many companies were in areas close to the waste management site in Thilafushi. GMIZL highlighted that there are discrepancies in utility services available in the different zones of the island, that the “old Thilafushi” identified in the map as “silver plots” did not have water and sanitation services available. They also guided the survey team to identify the size and type of tenants in the different zones of the islands. Care was taken to ensure that the sample represented residents living/ and working in sites near all areas/ zones in the islands. To maximize on the quality, a comprehensive list of tenants was obtained from GMIZL. See *Appendix A* for the list of tenants located in Thilafushi, obtained from GMIZL and *Appendix B* for maps of Thilafushi and Gulhifalhu with the surveyed companies located.

## **2.4 Data Collection**

### **2.4.1 Questionnaire**

The survey was carried out using two questionnaires based on socio economic variables - one for individuals working and/ or residing in Thilafushi and Gulhifalhu and the other for companies based in Thilafushi and Gulhifalhu Islands. The sample covered 430 individuals (Thilafushi 374; Gulhifalhu 56) and 35 companies (Thilafushi 32; Gulhifalhu 3).

The questionnaires were developed to elicit the most important quantifiable data for this assessment. The questionnaires included various research questions that intended to get information for the research areas, specifically,

- a. Provision and accessibility to basic services including;
  - Accommodation
  - Food
  - Healthcare
- b. Expenses on basic needs and savings
- c. Waste management
- d. Factors influencing waste management practices
- e. Readiness to use improved waste management services

The questionnaires were modified in line with the societal norms, adapted to the local context and was translated in Dhivehi. The questionnaires were field-tested and refined based on the experience gained by the field test. The modified questionnaires are included in *Appendix C*.

## **2.5 Data Analysis**

### **2.5.1 Data entry, analysis, synthesis and interpretation**

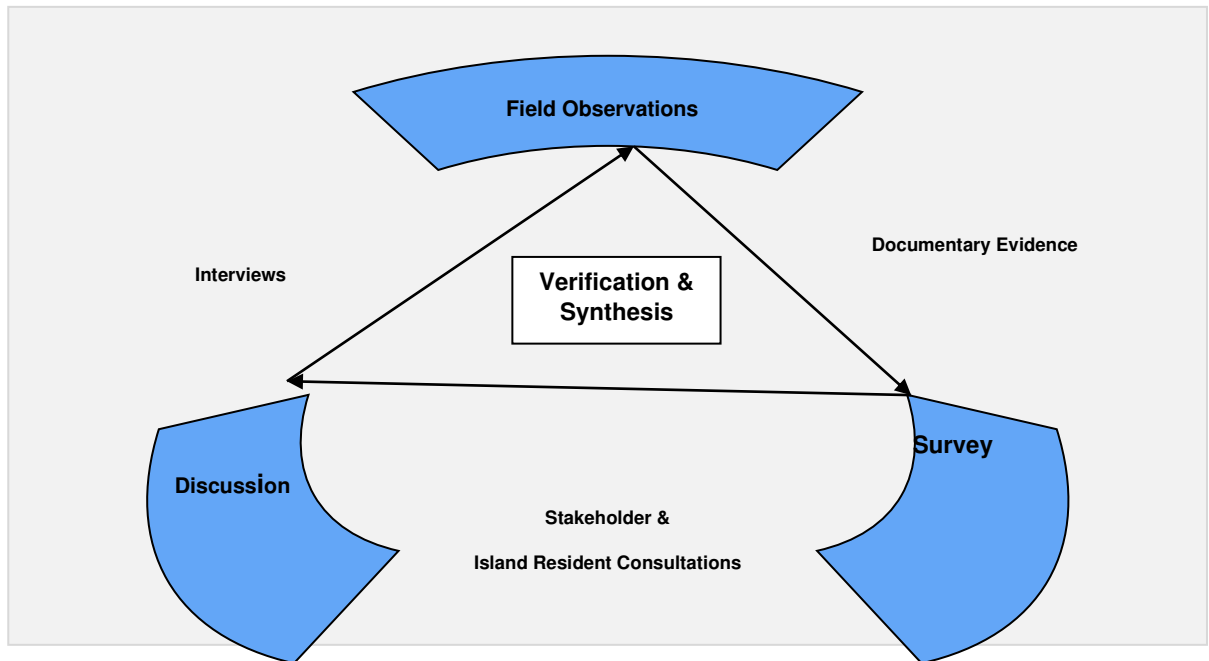
The questionnaires were filled by trained enumerators using tablet computers or smart phones in order to ensure efficiency and accuracy. The data were automatically entered, coded and fed into a central data base.

Data analysis and tabulation were carried out using a set of tables prepared by the Consultant's Team and shared with the client for feedback and comments.

### **2.5.2 Integration of Different Information Gathering Processes**

Findings of field research were triangulated and documented to ensure their credibility and validity. Information gathered from the different sources were checked through comparisons and verification discussions. For example, information from surveys was cross checked with information gathered from discussions with client, project documents and observations. Consultant compared data mainly from these three sources prior to making conclusions and reporting. Evidence from secondary sources including stakeholder consultation and interviews were used as supplementary sources of information to support the findings gathered from the above three key sources. Following figure illustrates the triangulation process of data that was gathered from various methods under this study.

**Figure 2: Triangulation of raw data collected from different methods**



### **3. Key Findings**

#### **3.1 General Information**

The survey respondents comprised of 1 female and 429 males. The respondents' ages ranged from 18 to 67 and are mostly Muslims (81%) and from Bangladesh (66%). The length of stay of the respondents in Maldives ranged from less than one year to more than 35 years. 78 percent of the respondents stated that they had a work visa or permit, 18 percent did not have a work visa or work permit and 3 percent did not want to respond to the question. Note that Maldivians (15%) do not need a permit to work in Thilafushi and Gulhifalhu. Hence, out of the 85 percent of foreign respondents, approximately 66 percent had a work visa or permit.

The education level of the respondents' showed that 9 percent did not have any education, 12 percent had basic literacy skills, 25 percent completed primary and 39 percent completed secondary education (secondary school and O'level), 7 percent have completed A'level and 4 percent have completed degree and above.

The education level was reflected in the job titles that the respondents hold as 54 percent of the respondents were unskilled labourers, 35 percent skilled workers, 7 percent at supervisor level, 1 percent at managerial level and 3 percent of the respondents' held jobs that were not categorized in any of the above mentioned categories.

The key points that emerged from the study are;

#### **3.2 Income, Expenditure and Savings**

- The self-assessed economic status showed that 24 percent respondents perceived themselves to be poor. The proportion of respondent who felt that they were in the lower middle-income level to middle income level constituted approximately 70 percent. Two percent respondents believed that they are rich.

- The highest expenditure for the respondents was estimated to be on communication (phone and internet) and the average monthly spent monthly ranged from MVR 500 to MVR 1500. The monthly expenditure on accommodation and basic needs such as utilities, food and drinks, and health care were borne by the employers and respondents had to spend minimal amount on these (Refer Table 1 below).

**Table 1: Summary of expenditure**

Expenditure (MVR)	Number of people who spent on:						
	B2. Food & Drinks	B3. House Rent	B4. House Maintenance	B5. Healthcare	B6. Electricity	B7. Water	B8. Communication
0-499	253	395	404	396	402	403	149
500-999	40	1	7	14	9	13	205
1000-1499	47	3	3	10	5	2	45
1500-1999	36	3	2	1	3	1	14
2000-2499	15	1	3	4	5	6	11
2500-2999	1	1	2	0	1	0	0
3000-3499	13	2	2	1	0	1	2
3500-3999	2	1	1	0	0	2	0
4000-4499	5	1	1	0	1	1	2
Above 5000	18	22	5	4	4	1	2

- The respondents stated that their average savings would be about 60 to 80 percent of the monthly income and 78 percent of the respondents send their savings to their families in respective countries.

**Table 2: Summary of Income**

Place of Residence	No. of respondents' – Summary of Income (MVR)			
	Below poverty line (<2000 MVR)	2001-4000	4001-6000	>6000
Male'	2	7	3	40
Thilafushi	19	46	140	119
Gulhifalhu	5	14	19	14
Boat	0	0	2	1
Other	1	0		2
<b>Total</b>	<b>27</b>	<b>67</b>	<b>164</b>	<b>176</b>

- Note: As indicated in the initial communications with the client, it was anticipated that a lot of people would hesitate to provide accurate data for income and expenditure, since the state is preparing to decree income tax. It appears that the data on expenditure and savings have errors and inconsistencies due to this. The main observation is that the lowest incomes estimated from the data received range from MVR200 to MVR500, some of whom are local and foreign nationals serving as technical/skilled employees. No local would work on a full-time job for a salary that is less than MVR5000, specifically in this job category. Additionally, the lowest income for foreign laborers will not be less than USD200, i.e., approximately 3000 per month.



### **3.3 Housing, Infrastructure and Basic Services**

- Majority of the respondents lived in Thilafushi (74%) and the rest of the respondents lived in Male' (12%), Gulhifalhu (12%) and in a boat or a dhoni (1%).
- 46 percent of the respondents lived in shared rooms, 37 percent in living quarters, 14 percent in single rooms and 3 percent at the project worksite.
- In the majority of the accommodation that respondents lived, the walls are built with concrete blocks plastered with cement (60%) and the rest corrugated iron (25%), wood (12%) and stone (2%); and the roofs are mostly built with corrugated iron (87%).
- 58 percent of the respondents had a separate kitchen in their living premises and out of that 50% use cooking gas for cooking.
- Main sources of drinking water were house/building service connection (34%), public tap water from treated source (30%), bottled water (28%) and rainwater (4%). Similarly the source of water used for washing and bathing include house/building service connection (53%), public tap water from treated source (41%), and rainwater (2%)
- On average it was reported that respondents shared a toilet among 5 to 10 people and 96 percent of the toilets they used were flush latrine connected to piped sewer system. 15 respondents stated that they use alternated toilets and out of which 3 respondents used public toilets.
- For the question on whether respondents were aware of their rights, 39 percent said "Yes" and 61 percent said "No". In terms of respondents perception on what their basic rights were, majority said right to accommodation (33%) and the rest said right to food (30%), salary (29%), healthcare (29%), leave (26%), safe water and sanitation (26%) and number of working hours (23%).

### **3.4 Health Condition and Healthcare Services**

- 68 percent of the respondents surveyed had a health insurance and 46 percent had a health issue past six months. The common issues reported were fever (65%) and cold (9%). Other issues reported include asthma, breathing problems, throat pain and other body aches and pains.
- 94 percent of those who reported sick saw a doctor and 96 percent went to a health facility in Male'. This could be because a health facility was opened in Thilafushi only recently (July 2019) and with limited facilities and services.

**Table 3: Disease Incidence Summary**

Place of Residence	No. of respondents'			
	Asthma/Lung related/Allergies/Cold, cough, fever	Water-borne diseases	Vector-borne diseases	Skin diseases
Male'	16	0	2	0
Thilafushi	125	0	6	5
Gulhifalhu	5	0	0	0
Boat	0	0	0	0
Other (Villimale and Hulhumale)	0	0	0	0
<b>Total</b>	<b>146</b>	<b>0</b>	<b>8</b>	<b>5</b>

Note: Records of water and air borne diseases are not available.

### 3.5 Solid Waste Management

- Majority of the respondents (66%) and companies (76%) highlighted that they are aware of the health issues related to garbage while 32 percent of the respondents' 24 percent of the companies said that they are not aware of such issues.
- 46 percent of the respondents believed that garbage is a huge problem in their locality, 19 percent of the respondents believed that it is a problem while 8 percent of the respondents reported that they rarely have issues and 25 percent respondents said not an issue at all. Similarly, 46 percent of the companies believed that garbage is a huge problem in their locality, 43 percent believed that it is a problem while 3 percent reported that they rarely have issues and 6 percent said not an issue at all.
- 67 of the respondents and 83 percent of the companies reported that the present practice of waste disposal in Thilafushi, including burning caused health issues and majority of the respondents said main problem was health problems due to air pollution and smoke (59%). Other problems stated include problems due to flies (4%) and problems due to contamination of lagoon (1%).

Solid waste management survey was mostly focused on to the companies based in Thilafushi and Gulheefalhu Islands and hence the key findings stated below in this section are based on the company responses.

- 69 percent reported that they segregate waste while 29 percent said that they do not. The companies who segregate waste reported that they segregate waste into plastics (31%), organics (32%), paper (14%) and metal (51%).
- 6 percent of the companies have received training on waste management while the majority 94 percent reported that they have not received any training in this area.

However, 71 percent companies stated that training on solid waste management will be beneficial.

- 37 percent companies said that they sell recyclable materials, while the majority 63 percent said that they do not sell recyclable waste materials.
- 29 percent of companies had door to door waste collection service and 71 percent opted for private arrangement. The frequency of waste collection or disposal services include: daily (9%), weekly (12%), monthly (3%) and irregular (6%).
- 9 percent of the companies reported that they use WAMCO's services for waste disposal. 91 percent said that they made private arrangements. This was evident from the responses as 71 percent of the companies stated that they were poorly satisfied with the present waste collection mechanism.
- 62 percent of the companies said they pay for waste collection and 38 percent said that they did not pay. The amount, companies who were paying for waste disposal, range from MVR 500 – MVR 40,000.
- From the companies currently not using the services of WAMCO for waste disposal, 85 percent stated that they will shift to WAMCO if services were improved and 9 percent said they did not want. In addition, 91 percent companies are willing to pay a reasonable amount to WAMCO if waste disposal practices were improved.
- Most companies (65%) were not aware about Government's program on Solid Waste Management (SWM) improvement through Ministry of environment and WAMCO.

### **3.6 Other Issues**

Other socioeconomic issues, problems and concerns raised by the individual respondents and companies during the survey included:

- No electricity and water services available in some parts of Thilafushi
- No regulations on road safety and parking.
- No regular ferry services were available, hence, the residents had to hire speedboats if there was an emergency medical issue.
- Smoke inhalation is the main problem. Some days smoke becomes so thick that you will not be able to see the person standing next to you.
- No banks and other facilities available on the Islands and therefore, have to go to Male' to send money home.
- Currently, government charging a very high amount for waste disposal.
- Waste management is a hazard. Hope the government solves this problem soon

See *Appendix D* and *Appendix E* for graphical representation of data obtained from individual survey and company survey respectively.

## **4. Limitations**

- Time constraints – Since the timeframe for data collection was about 4 days, data collection process was rushed and enumerators may have missed some information given by the respondents. In addition, had to seek permission from the companies to conduct the survey and since most of the companies' heads were based in Male, it was difficult to contact them within the time frame and hence, was not able to get some data such as number of employees from all the companies surveyed.
- Communication – The translators were briefed about the survey. However, even translators were not able to comprehend some questions such as “Are you aware of your rights?” and explain to respondents. One reason for this could be that translators competency in formal Dhivehi language may be limited.
- Reluctant or refused to give information on certain questions such as salary and company assets.

## **5. Recommendations**

- Conduct regular assessments of the risk factors involved for residents of Thilafushi and Gulheefalhu and establish mechanisms to reduce risk factors including health hazards.
- Enhance health facility at Thilafushi with improved services to deal with emergency at all times.
- Have schedule ferries at night.
- Develop and improve the current waste management system used
  - Regular collection of waste
  - Create awareness and provide training on proper waste management and individual responsibility
  - Establish a system to collect payment based on the amount of garbage
  - Enact laws and regulations. Penalize those do not abide by the regulations
  - Train WAMCO staff on customer care and establish a grievance procedure and an efficient complaints system
  - Manage waste and abolish burning of waste to minimize health hazards.

## APPENDICES

### APPENDIX A: List of Tenants Located in Thilafushi

TENANT REGISTRY SHEET  GREATER MALE' INDUSTRIAL ZONE LIMITED				
#	TENANT NAME	ZONE	LOCATION	TYPE OF WORK
1	Aasandha Company Limited	Silver	Thilafushi 01	File Storage
2	Waste Management Corporation Limited	-	-	Waste management
3	Villa Hakatha Pvt Ltd	Platinum Plot	Thilafushi 02	LPG storage and refilling plant, bulk cement station, cement packing plant, cement storage, diesel petrol kerosene storage tank, LPG and oxygen, sale of cement and oil, warehousing and All works allowed in Thilafushi
4	Heavy Load Maldives Pvt Ltd			Loading and unloading harbor, warehousing and labor accomodation
5	MTCC	Platinum Plot	Thilafushi 02	Warehousing and slipway
6	MTCC	Gold Plot	Thilafushi 02	Boat building and boat repair
7	Silver Sands Pvt Ltd	Gold Plot	Thilafushi 01	Boat repair and slipway
8	Yacht Tours Maldives	-	-	Slipway work
9	Nalahiya Tradings Pvt Ltd	Platinum Plot	Thilafushi 02	Warehouse of construction materials Shop (by letter no: TCL-PRJ/PRIV/2018/005)
10	State Trading Organization Plc Ltd	Gold Plot	Thilafushi 02	Warehousing
11	Fuel Express Maldves Pvt Ltd	Platinum Plot	Thilafushi 01	Vessel building and servicing fiber glass work
12	Fuel Express Maldves Pvt Ltd	Platinum Plot	Thilafushi 01	Vessel building and servicing fiber glass work
13	Maldives Ports Limited	Platinum Plot	Thilafushi 01	Boat building and boat repair
14	Maldiv Gas Pvt Ltd	Platinum Plot	Thilafushi 01	LPG refilling
15	Villa Shipping & Trading Co. Pvt Ltd	Gold Plot	Thilafushi 02	Cooking gas, cement, oxygen tank, diesel, petrol, kerosene storage and sale ,warehousing , boat building and repair ,slipway, engine repair and maintenance workshop for land and sea vessel and labor accommodation
16	Apollo Holdings Pvt Ltd	Platinum Plot	Thilafushi 02	All Works allowed in Thilafushi
17	Sun Transport Pvt Ltd	TIZ	TIZ	Boat Yard
18	Maldiv Gas Pvt Ltd	Platinum Plot	Thilafushi 01	LPG
19	Gulf Craft Service Centre Maldives Pvt Ltd	Gold Plot	Thilafushi 02	Speed boat building and repair

20	Gulf Craft Service Centre Maldives Pvt Ltd	Gold Plot	Thilafushi 02	Vessel work
21	Nalahiya Tradings Pvt Ltd	Gold Plot	Thilafushi 02	Warehouse of construction materials
22	Universal Enterprises Pvt Ltd	Platinum Plot	Thilafushi 01	Boat repair
23	Ahmed Luthfee	Platinum Plot	Thilafushi 01	Fiber glass speed boat & fishing boat building and boat repair
24	R.K.L Group Pvt Ltd	Platinum Plot	Thilafushi 01	Warehousing and related works, Cement brick and related works, heavy vehicle parking and repairing related works, land and sea vessel building and repairing and related works
25	Coastline Investments Pvt Ltd	Platinum Plot	Thilafushi 01	Warehousing
26	Al Shaali Marine Maldives Pvt Ltd	Platinum Plot	Thilafushi 01	Vessel repair
27	Coastline Investments Pvt Ltd	Platinum Plot	Thilafushi 01	Vessel repair, all works allowed in Thilafushi, diesel storage tank and warehousing
28	VA Pvt Ltd	Platinum Plot	Thilafushi 02	Warehousing
29	Nalahiya Construction Material	platinum Plot	Thilafushi 02	Warehousing
30	Agas Maldives Pvt Ltd	Gold Plot	Thilafushi 01	Warehousing & land and sea vessel building
31	Uniforce Investment Pvt Ltd	Gold Plot	Thilafushi 01	Warehousing and land and sea vessel building
32	Coastline Investments Pvt Ltd	Silver Plot	Thilafushi 01	Vessel repair
33	Fuel Supplies Maldives Pvt Ltd	Platinum Plot	Thilafushi 01	Vessel building and repair, workshop, labor accommodation and warehousing
34	State Trading Organization Plc Ltd	-	-	N/A
35	Maldives Structural Products Pvt Ltd	Gold Plot	Thilafushi 02	Production of metal sheet
36	Static Company Pvt Ltd	Gold Plot	Thilafushi 01	RO plant workshop (desalination plant manufacturing), workshop (welding, lathing, engineering and repair works, panel making), fiber works, warehousing and labor accommodation
37	Villa Hakatha Pvt Ltd	Gold Plot	Thilafushi 02	All works allowed in Thilafushi
38	Waste Management Corporation Limited	-	-	warehousing, accommodation block, parking, garage, recycle facility and office building
39	Tommy Engineering Pvt Ltd			Boat Yard
40	Ministry of Defence and National Security	-	-	MNDF works

41	State Electric Company Ltd	Silver Plot	Thilafushi 02	Electricity services to Thilafushi
42	Apollo Holdings Pvt Ltd	Gold Plot	Thilafushi 02	All Works allowed in Thilafushi
43	Apollo Holdings Pvt Ltd	Gold Plot	Thilafushi 02	All Works allowed in Thilafushi
44	Timber House Pvt Ltd	Silver Plot	TIZ	Wood storage and other works
45	The Hawks Pvt Ltd	Platinum Plot	Thilafushi 01	Retail shop, oil supply, brick work, café and boat building
46	Secure Bag (Maldives) Pvt Ltd	Gold Plot	Thilafushi 01	-
47	Muni Enterprises Pvt Ltd	Silver Plot	Thilafushi 01	Warehousing
48	A.H. Brothers Pvt Ltd	Silver	Thilafushi 01	Warehousing
49	Alia Investments Pvt Ltd	TIZ	TIZ	Auto Mobile/ Motor Vehicle
50	Amin Construction Pvt Ltd	Silver Plot	Thilafushi 01	Warehousing and Carpentry work
51	Apollo Holdings Pvt Ltd	Gold Plot	Thilafushi 02	All Works allowed in Thilafushi
52	Ego Maldives Pvt Ltd	TIZ	TIZ	Warehousing and Carpentry work
53	Marine Export & Trading Company Pvt Ltd	Silver Plot	Thilafushi 01	Warehousing and vehicle repair
54	Rainbow Aluminum Pvt Ltd	Gold Plot	Thilafushi 02	Construction work and aluminum works
55	Rainbow Enterprises	Gold Plot	Thilafushi 02	Warehousing, Furniture production and related works
56	Vimla Construction and Trade Pvt Ltd	Silver Plot	Thilafushi 01	Warehousing, carpentry and labor accommodation
57	Alia Investments Pvt Ltd	TIZ	TIZ	Industrial Equipments/ Marine Power Generation
58	Moosa Kaleem	Silver Plot	-	Warehousing of construction materials, hardware materials GI pipe and structural beam
59	Heavy Dockyard Maldives Pvt Ltd	Platinum Plot	Thilafushi 01	All Works allowed in Thilafushi
60	Coastline Investments Pvt Ltd	Silver Plot	Thilafushi 01	Warehousing
61	Universal Enterprises Pvt Ltd	Platinum Plot	Thilafushi 01	Warehousing
62	Mild Steel Maldives Pvt Ltd	Gold Plot	Thilafushi 01	Boat yard
63	Sonee Hardware Pvt Ltd	TIZ	TIZ	General hardware and Warehousing
64	Sonee Hardware Pvt Ltd	TIZ	TIZ	General hardware and Warehousing
65	Sonee Hardware Pvt Ltd	TIZ	TIZ	General hardware and Warehousing
66	Mafhaa Private Limited	Gold Plot	Thilafushi 01	Boat building and boat repair
67	Coastline Investments Pvt Ltd	Platinum Plot	Thilafushi 01	Warehousing
68	Heavy Dockyard Maldives Pvt Ltd	Platinum Plot	Thilafushi 01	All Works allowed in Thilafushi
69	Aima Construction Pvt Ltd	TIZ	TIZ	brick works

70	Umet Construction Pvt Ltd	Silver Plot	Thilafushi 01	Warehousing and construction work
71	Mohamed Manik	Gold Plot	Thilafushi 01	Warehousing
72	Sunfront Pvt Ltd	-	-	Warehousing
73	MWSC	TIZ	TIZ	Water production and distribution system
74	Coastline Investments Pvt Ltd	Silver Plot	Thilafushi 01	Warehousing
75	Apollo Holdings Pvt Ltd	Platinum Plot	Thilafushi 02	All Works allowed in Thilafushi
76	Maldive Gas Pvt Ltd	Platinum Plot	Thilafushi 01	Buffer zone
77	Sunfront Pvt Ltd	Gold Plot	Thilafushi 01	Warehousing
78	Far Horizon Pvt Ltd	Silver Plot	Thilafushi 01	Fish processing plant, ice plant, aquaponics, fiber tub construction, boat construction and boat repair
79	Maziya Service Pvt Ltd	TIZ	TIZ	fabrication and wood work
80	Maldives Ports Limited	-	-	Vehicle storage
81	Sun Transport Pvt Ltd	TIZ	TIZ	Godown ,carpentary , fiber glass works and workshop
82	Abdul Latheef	TIZ	TIZ	Alluminium Workshop
83	Maldives Petroleum Link Pvt Ltd	Platinum Plot	Thilafushi 01	Warehousing and oil works
84	Vermillion International Pvt Ltd	Gold Plot	Thilafushi 01	Warehousing, boat building, machanicale engineering and brick production
85	Simdi Company Pvt Ltd	Gold Plot	Thilafushi 01	Warehousing
86	Nazaki Aluminium Pvt Ltd	Silver Plot	Thilafushi 01	Warehousing and aluminum workshop
87	Heavy Load Maldives Pvt Ltd	Silver Plot	Thilafushi 01	All works allowed in Thilafushi
88	Marine Export & Trading Company Pvt Ltd	Silver Plot	Thilafushi 01	Warehousing
89	Leo Trading Pvt Ltd	Silver Plot	Thilafushi 01	Warehousing, parking , vehicle repair and temporary labor accommodation
90	Beach Marine Pvt ltd	TIZ	TIZ	Workshop
91	Aaru Pvt Ltd	Silver	Thilafushi 01	Warehousing
92	Abbas Abdulla	Gold	Thilafushi 02	Warehousing of Construction Materials
93	Agas Maldives Pvt Ltd	Gold Plot	Thilafushi 01	Warehousing
94	Ahmed Mujah	Silver Plot	Thilafushi 01	Warehousing, Work shop and live fish
95	Aima Construction Pvt Ltd	Silver Plot	Thilafushi 01	Warehousing & Carpentry
96	Ali Abdulla	Gold Plot	Thilafushi 2	Warehousing/Construction Materials
97	Ali Muththalib	TIZ	TIZ	Warehousing, fiber works & workshop
98	Al Shaali Marine Maldives Pvt Ltd	Platinum Plot	Thilafushi 01	Vessel repair
99	Apollo Holdings Pvt Ltd	Platinum Plot	Thilafushi 02	All Works allowed in Thilafushi
100	Aries Enterprises Pvt Ltd	TIZ	TIZ	Warehousing



101	Coastline Investments Pvt Ltd	Silver Plot	Thilafushi 01	Warehousing
102	FW Construction Company Pvt Ltd	Silver Plot	Thilafushi 01	Warehousing and workshop
103	Fuel Supplies Maldives Pvt Ltd	Silver Plot	Thilafushi 01	Oil works
104	Maldives Petroleum Link Pvt Ltd	Platinum Plot	Thilafushi 01	Workshop and oil works
105	Heavy Force Pvt Ltd	Gold Plot	Thilafushi 01	Vehicle repair
106	Ibrahim Abdul Latheef	-	-	Workshop
107	Ismail Shafeeu	Silver Plot	Thilafushi 01	Warehousing
108	M.T Hojgaard Pvt Ltd	TIZ	TIZ	Concrete work, carpentry, welding and boat repair
109	Nakachafushi Island Resort	Silver Plot	Thilafushi 01	Warehousing
110	Nalahiya Tradings Pvt Ltd	Silver Plot	Thilafushi 01	Warehousing
111	Olhahali Investment Pvt Ltd	Gold Plot	Thilafushi 01	Warehousing
112	Reollo Enterprise Pvt Ltd	TIZ	TIZ	Warehousing and workshop
113	Sunfront Pvt Ltd	Gold Plot	Thilafushi 01	Warehousing
114	Sunfront Pvt Ltd	Gold Plot	Thilafushi 01	Warehousing
115	Sunland Trading Company Pvt Ltd	Silver Plot	Thilafushi 01	Warehousing
116	Tep Construction Pvt Ltd	TIZ	TIZ	Warehousing of Construction Materials
117	Vista Investments Pvt Ltd	Silver Plot	Thilafushi 01	Warehousing and construction work
118	Amin Construction Pvt Ltd	TIZ	TIZ	Warehousing
119	Ahmed Luthfee	Silver Plot	Thilafushi 01	Fiber glass speed boat & fishing boat building and boat repair
120	Moosa Kaleem	Silver Plot	Thilafushi 01	Warehousing
121	Adam Ibrahim	Silver	Thilafushi 01	Warehousing
122	Alia Construction Pvt Ltd	TIZ	TIZ	Warehousing, workshop, carpentry, labor quarter, vessel building, garage and parking zone
123	Umar Zahir	Silver Plot	Thilafushi 01	Warehousing
124	Sandcays Pvt Ltd	TIZ	TIZ	Warehousing and labor accommodation
125	Mohamed Ahmed Abdulla	Silver Plot	Thilafushi 01	Warehousing
126	Coastline Investments Pvt Ltd	Silver Plot	Thilafushi 01	Vessel repair and vessel building
127	Hussain Mohamed Fulhu	Silver Plot	Thilafushi 01	All works allowed in Thilafushi
128	Marine Coral Maldives Pvt Ltd	Silver Plot	Thilafushi 01	Warehousing
129	Mohamed Moosa	Silver Plot	Thilafushi 01	Warehousing
130	Ibrahim Rasheed Ali	Silver Plot	Thilafushi 01	Wood warehousing and wood works
131	Waste Management Corporation Limited	-	-	warehousing, accommodation block, parking, garage, recycle facility and office building

132	Mass Enterprises Pvt Ltd	Silver Plot	Thilafushi 01	Wood warehousing and wood works
133	Aima Construction Pvt Ltd	TIZ	TIZ	Vehicle and Barge repair
134	Ali Naashid	Silver Plot	Thilafushi 01	Wood warehousing & wood works
135	Alia Investments Pvt Ltd	Silver Plot	Thilafushi 01	Wood warehousing and wood works
136	FW Construction Company Pvt Ltd	Silver Plot	Thilafushi 01	Wood warehousing and wood works
137	Far Horizon Pvt Ltd	Silver Plot	Thilafushi 01	Wood warehousing and wood works
138	Ibrahim Hassan	Silver Plot	Thilafushi 01	Wood warehousing and wood works
139	Onus Pvt Ltd	Silver Plot	Thilafushi 01	Warehousing
140	Sunfront Pvt Ltd	-	-	Warehousing and Carpentry work
141	Timber House Pvt Ltd	Silver Plot	Thilafushi 01	Wood storage and other works
142	Timber Trade Pvt Ltd	Silver Plot	Thilafushi 01	Wood storage and other works
143	Ali Shareef	Silver Plot	Thilafushi 01	Warehousing
144	Ahmed Sinah	Platinum Plot	Thilafushi 01	Dockyard
145	Coastline Investments Pvt Ltd	Silver Plot	Thilafushi 01	All works allowed in Thilafushi
146	Maldives Petroleum Link Pvt Ltd	Platinum Plot	Thilafushi 01	Warehousing
147	Heavy Load Maldives Pvt Ltd	Silver Plot	Thilafushi 01	All works allowed in Thilafushi, except works stated in clause 12 of the agreement.
148	Aaru Pvt Ltd	Silver	Thilafushi 01	Warehousing
149	Hello Maldives Pvt Ltd	Gold Plot	Thilafushi 01	Fish processing plant, ice plant, aquaponics, fiber tub construction, boat construction and boat repair
150	Silver Sands Pvt Ltd	Gold Plot	Thilafushi 01	All works allowed in Thilafushi
151	Bio Diversity Education and Awareness Maldives (BEAM)	-	-	Collecting, segregating and bailing ocean plastic
152	Marine Coral Maldives Pvt Ltd	Silver Plot	Thilafushi 01	Warehousing and brick works
153	Damas Company Pvt Ltd	Silver Plot	Thilafushi 01	Warehousing and workshop
154	Leo Trading Pvt Ltd	Gold Plot	-	Warehousing and workshop (Heavy vehicle maintenance and services)
155	Mild Steel Maldives Pvt Ltd	-	-	Warehousing
156	Maldives Structural Products Pvt Ltd	Gold Plot	Thilafushi 02	Warehousing
157	Island Engineering Services and Supplies Pvt Ltd	Silver Plot	Thilafushi 01	Warehousing
158	Static Company Pvt Ltd	Silver Plot	Thilafushi 01	Warehousing
159	Damas Company Pvt Ltd	Silver Plot	Thilafushi 01	Vehicle repair and vehicle storage

160	The Hawks Pvt Ltd	Silver Plot	Thilafushi 01	Bric work, fiber work and carpentry
161	Hussain Khalid	Silver Plot	Thilafushi 01	Warehousing, hotel, shop and labor accommodation
162	Ismail Adil	Silver Plot	Thilafushi 01	Warehousing
163	Hassan Haleem	Silver Plot	Thilafushi 01	Brick work
164	Mohamed Sameer	Silver Plot	Thilafushi 01	Brick work
165	Tep Construction Pvt Ltd	Silver Plot	Thilafushi 01	Warehousing of Construction Materials
166	Monaza Contracting Company Pvt Ltd	Silver Plot	Thilafushi 01	Carpentry, staff accommodation, café, workshop and saloon
167	Mohamed Majid	Silver Plot	Thilafushi 01	Warehousing and Tailor work
168	Saroor Naazim	TIZ	TIZ	Non Flammable works
169	Aaru Pvt Ltd	Silver	Thilafushi 01	Labor Accommodation
170	Agas Maldives Pvt Ltd	Silver Plot	Thilafushi 01	Warehousing
171	Ahmed Sameeru	Silver Plot	Thilafushi 01	Warehousing
172	Ahmed Sinah	TIZ	TIZ	Warehousing
173	Ahmed Zareer	TIZ	TIZ	Warehousing
174	Aima Construction Pvt Ltd	Silver Plot	Thilafushi 01	Warehousing
175	Aima Construction Pvt Ltd	Silver Plot	Thilafushi 01	All works allowed in Thilafushi
176	Ali Ibrahim Rashid	TIZ	TIZ	Warehousing
177	Apollo Holdings Pvt Ltd	Platinum Plot	Thilafushi 02	All Works allowed in Thilafushi
178	Asian Power Investment Pvt Ltd	TIZ	TIZ	Warehousing and workshop
179	Coastline Investments Pvt Ltd	Silver Plot	Thilafushi 01	Warehousing and vehicle repair
180	Coastline Investments Pvt Ltd	Silver Plot	Thilafushi 01	Warehousing
181	Dhivehi Meysthiri Pvt Ltd	Silver Plot	Thilafushi 01	All Works allowed in Thilafushi
182	Dhivehi Meysthiri Pvt Ltd	Silver Plot	Thilafushi 01	Carpentry
183	Dynamic Construction and Trading Pvt Ltd	Silver Plot	Thilafushi 01	Warehousing and brick works
184	Farifeyran Pvt Ltd	Silver Plot	Thilafushi 01	Brick work, warehousing, cement works, carpentry, workshop, metal works, fiber works, sale of wood and hardware construction work
185	Faunu Enterprises Pvt Ltd	Gold Plot	Thilafushi 01	Vessel repair Shop (by letter no: TCL-LEGAL/PRIV/2018/025)
186	Haajaraa Workshop	Silver Plot	Thilafushi 01	Warehousing and machinery repair
187	Maldives Petroleum Link Pvt Ltd	TIZ	TIZ	Warehousing, labor accommodation and maintenances work
188	Maldives Petroleum Link Pvt Ltd	TIZ	TIZ	Warehousing, labor accommodation and maintenances work

189	Ibrahim Majid	TIZ	TIZ	Warehousing and Compact works of steel and plastic
190	Ilyas	Silver Plot	Thilafushi 01	Workshop
191	Ismail Hilmy	Silver Plot	Thilafushi 01	Warehousing
192	Ismail Zahir	TIZ	TIZ	Vessel repair
193	Ives Pvt Ltd	TIZ	TIZ	Warehousing and workshop
194	Jausa Holdings Pvt Ltd	Silver Plot	Thilafushi 01	Warehousing
195	LuckyHiya Maldives Pvt Ltd	Silver Plot	Thilafushi 01	Warehousing and Carpentry work
196	Maldives Road Development Corporation Limited	Silver Plot	Thilafushi 01	Brick works site office
197	Mohamed Moosa	Silver Plot	Thilafushi 01	Brick work, warehousing, cement works, carpentry, workshop, metal works, fiber works, sale of wood and hardware construction work
198	Mohamed Naasih	Silver Plot	Thilafushi 01	Vehicle repair
199	Mohamed Shareef	TIZ	TIZ	Warehousing and services
200	Muaz Mohamed	TIZ	TIZ	Warehousing
201	Muni Enterprises Pvt Ltd	TIZ	TIZ	Carpentry
202	MWSC	Platinum Plot	Thilafushi 01	Water plant and other water related works
203	MWSC	Platinum Plot	Thilafushi 01	Water supply for Thilafushi
204	Ocean Brilliant Sea Food International Pvt Ltd	TIZ	TIZ	Fish processing
205	Prop Pvt Ltd	-	-	N/A
206	Rasheed Carpentry & Construction Pvt Ltd	Silver Plot	Thilafushi 01	Carpentry
207	Rasheed Carpentry & Construction Pvt Ltd	Silver Plot	Thilafushi 01	Warehousing and Carpentry work
208	The Hawks Pvt Ltd	Silver Plot	Thilafushi 01	Warehousing, vehicle repair, brick work, oil storage, retail business, boat building and café
209	Universal Enterprises Pvt Ltd	Silver Plot	Thilafushi 01	Labor Accommodation
210	Vantha Pvt Ltd	TIZ	TIZ	Warehousing, labor accommodation and boat building and repair
211	Villa Hakatha Pvt Ltd	Platinum Plot	Thilafushi 02	Warehousing
212	Villa Hakatha Pvt Ltd	Gold Plot	Thilafushi 02	All works allowed in Thilafushi
213	Damas Company Pvt Ltd	Silver Plot	Thilafushi 01	All Works allowed in Thilafushi
214	Maziya Service Pvt Ltd	TIZ	TIZ	Warehousing
215	Hassan Jawhary	Silver Plot	Thilafushi 01	Warehousing
216	Damas Company Pvt Ltd	Silver Plot	Thilafushi 01	Warehousing
217	Sirius Enterprises Pvt Ltd	Silver Plot	Thilafushi 01	Warehousing
218	Ahmed Lilal			building material storage
219	Sirius Enterprises Pvt Ltd	Silver Plot	Thilafushi 01	Warehousing
220	Eye Care Pvt Ltd	TIZ	TIZ	Warehousing, workshop and café

221	Ahmed Sameeru	Silver Plot	Thilafushi 01	Warehousing and Vessels/Vehicle repair
222	Thoha Mohamed	TIZ	TIZ	Warehousing and Carpentry work
223	Abdul Muhsin Hussain	Gold	-	Warehousing
224	Coastline Investments Pvt Ltd	Silver Plot	Thilafushi 01	N/A
225	Marine Coral Maldives Pvt Ltd	Silver Plot	Thilafushi 01	Warehousing
226	Marine Coral Maldives Pvt Ltd	Silver Plot	Thilafushi 01	Warehousing
227	Meridium Services Pvt Ltd	Silver Plot	Thilafushi 01	Warehousing and oil works
228	Tennssoor Holdings Pvt Ltd	TIZ	TIZ	Warehousing and workshop
229	Wheel Pvt Ltd	Silver Plot	Thilafushi 01	Warehousing and workshop
230	Asian Power Investment Pvt Ltd	TIZ	TIZ	Vessel repair and production of machine
231	Mario Maldives Pvt Ltd	Silver Plot	Thilafushi 01	Construction work
232	Haneefa Exzim Investment	Silver Plot	Thilafushi 01	Warehousing
233	Ahmed Sameeru	Silver Plot	Thilafushi 01	Warehousing and Workshop
234	Asir Nizar	Silver Plot	Thilafushi 01	Workshop
235	The Wiz Company Pvt Ltd	Silver Plot	Thilafushi 01	Warehousing
236	Mohamed Yoosuf	TIZ	TIZ	Warehousing and brick works
237	Ali Ahmed	TIZ	TIZ	Warehousing, Café, Shop & Workshop
238	The Hawks Pvt Ltd	Silver Plot	Thilafushi 01	Retail shop, oil supply, brick work, café and boat building
239	Ahmed Luthfee	Silver Plot	Thilafushi 01	Fiber glass speed boat & fishing boat building and boat repair
240	LoneStar Pvt Ltd	Silver Plot	Thilafushi 01	Warehousing, workshop and labor accommodation
241	Maldives Petroleum Link Pvt Ltd	TIZ	TIZ	Warehousing, labor accommodation and maintenances work
242	Mohamed Waheed Hassan	TIZ	TIZ	Warehousing, shop, café and workshop
243	Rayline Services Pvt Ltd	TIZ	TIZ	Warehousing
244	Mario Maldives Pvt Ltd	Silver Plot	Thilafushi 01	Construction work
245	The Hawks Pvt Ltd	Silver Plot	Thilafushi 01	Retail shop, oil supply, brick work, café and boat building
246	Denicon Construction & Trading Pvt Ltd	Silver Plot	Thilafushi 01	Warehousing and construction work
247	Ahmed Naseer	TIZ	TIZ	Warehousing
248	Rishtha Company Pvt Ltd	TIZ	TIZ	Warehousing and brick works
249	Tennssoor Holdings Pvt Ltd	TIZ	TIZ	Heavy machinery storage and services
250	Abdulla Abdul Sattar	Silver	Thilafushi 01	Workshop
251	Abdulla Salih	TIZ	TIZ	Warehousing & Workshop
252	Afeef Mohamed	TIZ	TIZ	Labor Accommodation & Café Fiber Glass Work (Allowed through letter)

253	Ahmed Amir	Silver	Thilafushi 01	All Works allowed in Thilafushi
254	Ahmed Mujah	TIZ	TIZ	Warehousing
255	Ali Abdulla	Silver Plot	Thilafushi 01	Workshop
256	Ali Ahmed	TIZ	TIZ	Warehousing, Café, Shop & Workshop
257	Ali Rasheed	Silver Plot	Thilafushi 01	Warehousing
258	Alia Investments Pvt Ltd	TIZ	TIZ	Warehousing and workshop
259	Alia Investments Pvt Ltd	TIZ	TIZ	Warehousing and workshop
260	Alia Investments Pvt Ltd	TIZ	TIZ	Warehousing and workshop
261	Bric Construction	TIZ	TIZ	Workshop and warehouse
262	Coastline Investments Pvt Ltd	Silver Plot	Thilafushi 01	Warehouse
263	Denicon Construction & Trading Pvt Ltd	Silver Plot	Thilafushi 01	Labor Accommodation and shop
264	Dhiraagu	Silver Plot	Thilafushi 01	Mobile antenna
265	Gasim Mahmood	TIZ	TIZ	Workshop
266	Heavy Force Pvt Ltd	Gold Plot	Thilafushi 01	Engineering works
267	Hussain Khalid	TIZ	TIZ	Warehousing & labor accommodation
268	Hussain Nazeeh	Silver Plot	Thilafushi 01	Warehousing
269	Hussain Rasheed	TIZ	TIZ	Warehousing
270	Hussain Shiyam	TIZ	TIZ	Warehousing
271	Hussain Waheed	TIZ	TIZ	Workshop
272	Ibrahim Ali	TIZ	TIZ	Carpentry
273	Jiaz Maldives Pvt Ltd	Silver Plot	TIZ	Warehousing and labor accommodation
274	Meridium Services Pvt Ltd	Silver Plot	Thilafushi 01	Oil works
275	Misraab Trading Co Pvt Ltd	TIZ	TIZ	Warehousing
276	Mohamed Abdul Sattar	Silver Plot	TIZ	Warehousing
277	Mohamed Haleel	Silver Plot	-	Warehousing and workshop
278	Mohamed Musthag	TIZ	TIZ	Warehousing and workshop
279	Mohamed Naasih	-	-	Warehousing
280	Mohamed Rasheed Ahmed	Silver Plot	TIZ	Warehousing, café, workshop and shop
281	Mohamed Rasheed Hussain	TIZ	TIZ	Warehousing, workshop, brick work and machine production
282	Mohamed Shakir	Silver Plot	Thilafushi 01	Vehicle and engine repair
283	Mohamed Shareef	TIZ	TIZ	Metal sheet storage
284	Musthafa Fareed	TIZ	TIZ	Warehousing
285	Naadira Jameel	TIZ	TIZ	Show room and workshop
286	Nasrullah Abdul Waahid	TIZ	TIZ	Warehousing
287	Ocean Logistics Pvt Ltd	TIZ	TIZ	Warehousing of Construction Materials
288	Ooredhoo Maldives Pvt Ltd	Silver Plot	Thilafushi 01	Antenna
289	Pool Chemicals and Services Maldives Pvt Ltd	TIZ	TIZ	Radio station
290	Prestige Group Maldives Pvt Ltd	TIZ	TIZ	Warehousing

291	Relax Maldives Pvt Ltd	TIZ	TIZ	Warehousing, brick work and café
292	Relax Maldives Pvt Ltd	TIZ	TIZ	Warehousing, brick work and café
293	Relax Maldives Pvt Ltd	TIZ	TIZ	Brick work and workshop
294	Riffathulla Ali	TIZ	TIZ	Warehousing, café, workshop and shop
295	Riznee Mohamed	TIZ	TIZ	Warehousing, labor accommodation and hydroponics agriculture
296	Shen Maldives Raufa Construction Pvt Ltd	Silver Plot	Thilafushi 01	Warehousing and labor accommodation
297	Standard and Origin Pvt Ltd	TIZ	TIZ	Warehousing and workshop
298	Standard and Origin Pvt Ltd	TIZ	TIZ	Warehousing and workshop
299	Tennssor Holdings Pvt Ltd	TIZ	TIZ	Heavy machinery storage and services
300	Tennssor Holdings Pvt Ltd	TIZ	TIZ	Heavy machinery storage and services
301	Try On Maldives Pvt Ltd	TIZ	TIZ	Marine engineering workshop
302	Umar Zahir	Silver Plot	Thilafushi 01	Clinic
303	Urban Investment Pvt Ltd	TIZ	TIZ	Warehousing
304	Well Land Investment Pvt Ltd	TIZ	TIZ	Warehousing and making of name board
305	Ahmed Nizar	Silver Plot	Thilafushi 01	Garage
306	B Company Pvt Ltd	TIZ	TIZ	Godown
307	Hussain Musthaq	Silver Plot	Thilafushi 01	Warehousing
308	Sunfront Pvt Ltd	Silver Plot	Thilafushi 01	Warehousing of Construction Materials
309	Wheel Pvt Ltd	Silver Plot	Thilafushi 01	Workshop
310	Equalise Investment Pvt Ltd	TIZ	TIZ	Auto Repair and maintenance services
311	Aboobakuru Jauhary	TIZ	TIZ	Vehicles Paintings and cleaning works
312	Moosa Ali	TIZ	TIZ	metal fabrication
313	Aujaz Hassan	TIZ	TIZ	Workshop and brick work
314	Department of Public Health	Silver Plot	Thilafushi 01	Warehousing
315	Department of Public Health	Silver Plot	Thilafushi 01	Warehousing
316	State Electric Company Ltd	Silver Plot	Thilafushi 02	Electricity sevices to Thilafushi
317	State Electric Company Ltd	Silver Plot	Thilafushi 02	Electricity sevices to Thilafushi
318	State Electric Company Ltd	Silver Plot	Thilafushi 02	Electricity sevices to Thilafushi
319	State Electric Company Ltd	Silver Plot	Thilafushi 02	Electricity sevices to Thilafushi
320	Greater Male' Industrial Zone Limited		Thilafushi	Overall administration and management of Thilafushi and Gulhifalhu

**APPENDIX B: Maps of Thilafushi and Gulhifalhu with the surveyed individuals and companies located**

**INDIVIDUALS LOCATIONS**



**COMPANIES LOCATIONS**





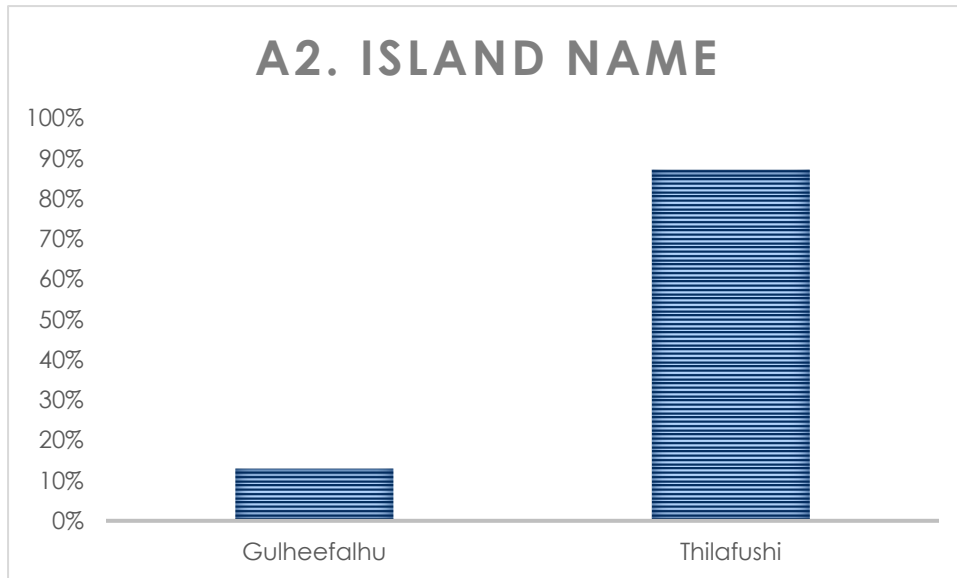
## **APPENDIX C: Questionnaires for Individual and Company Surveys**

**(Attached as a separate file)**

## APPENDIX D: Graphical representation of data obtained from individual survey

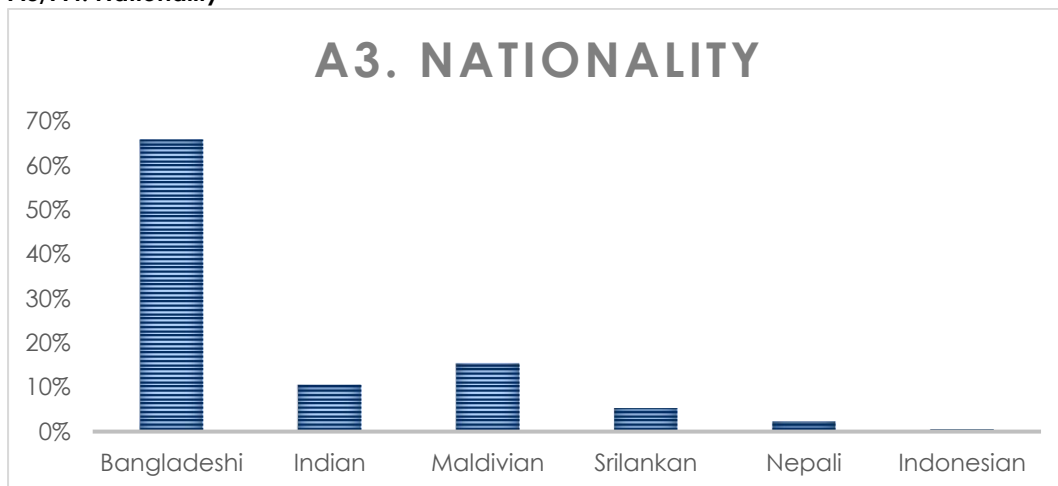
### A. GENERAL INFORMATION: RESPONDENT

#### A2. Island Name



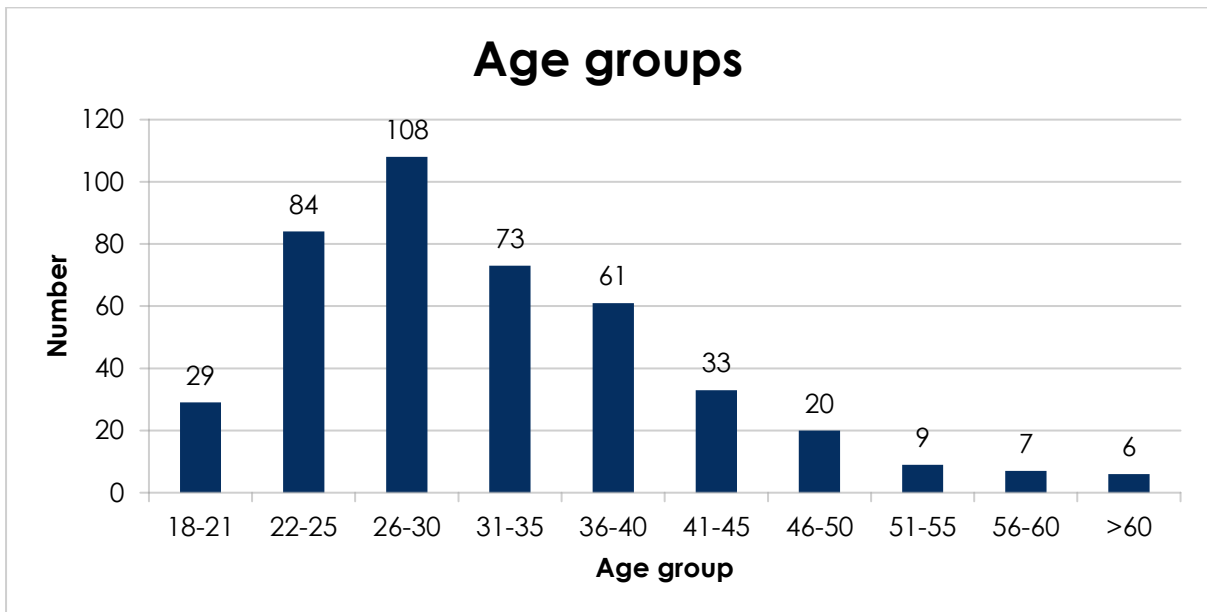
Gulheefalhu	56	13%
Thilafushi	378	87%

#### A3/A4. Nationality



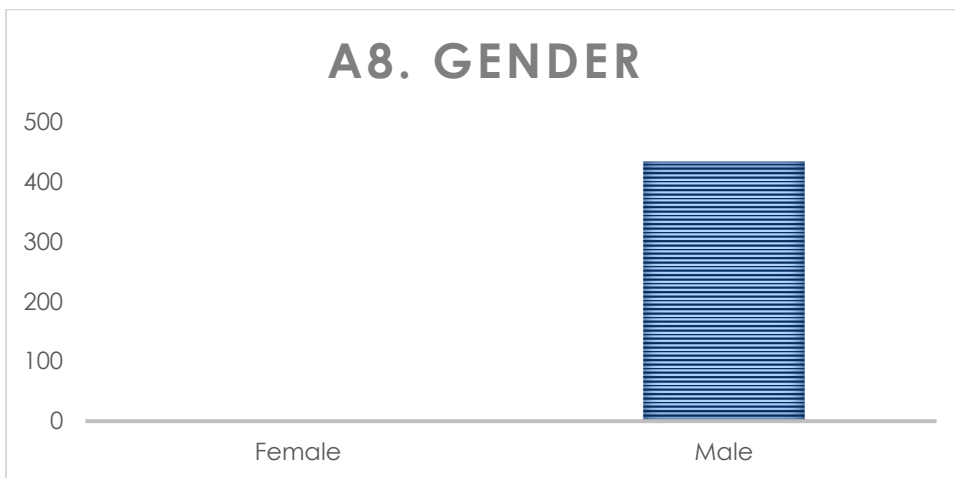
Bangladeshi	286	66%
Indian	46	11%
Maldivian	67	15%
Srilankan	23	5%
Nepali	10	2%
Indonesian	2	0%

**A7. Age group**



Age group	Count
18-21	29
22-25	84
26-30	108
31-35	73
36-40	61
41-45	33
46-50	20
51-55	9
56-60	7
>60	6
	<b>430</b>

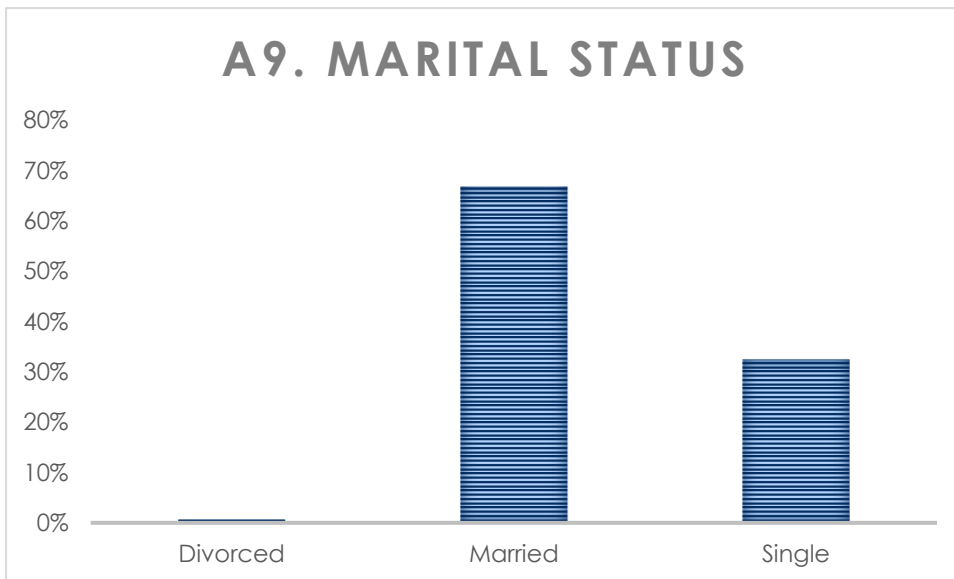
**A8. Gender**



Female	1
--------	---

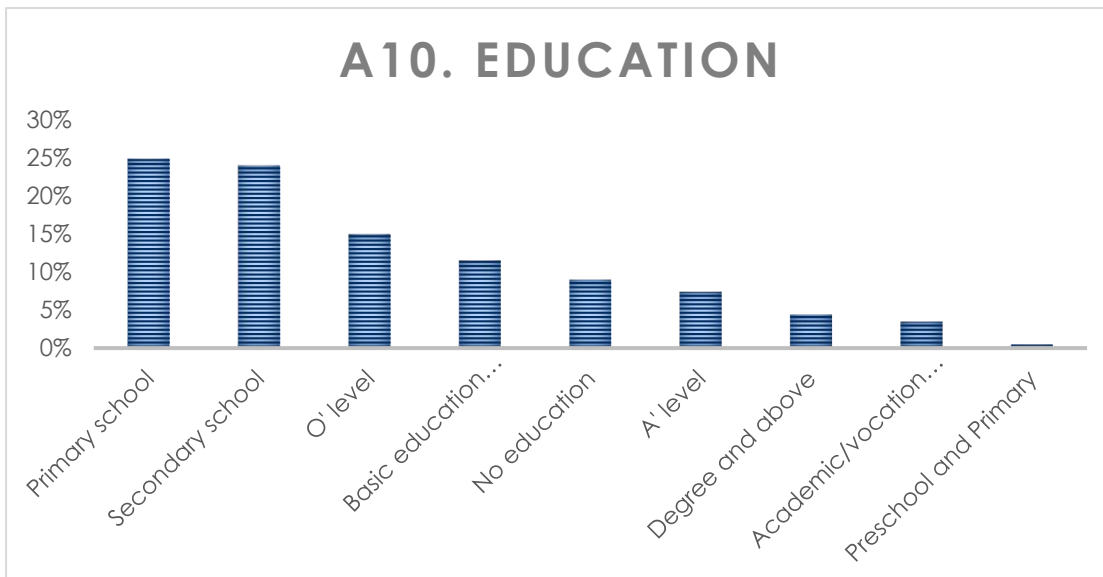
Male	429
------	-----

#### A9. Marital Status



Divorced	3	1%
Married	290	67%
Single	141	32%

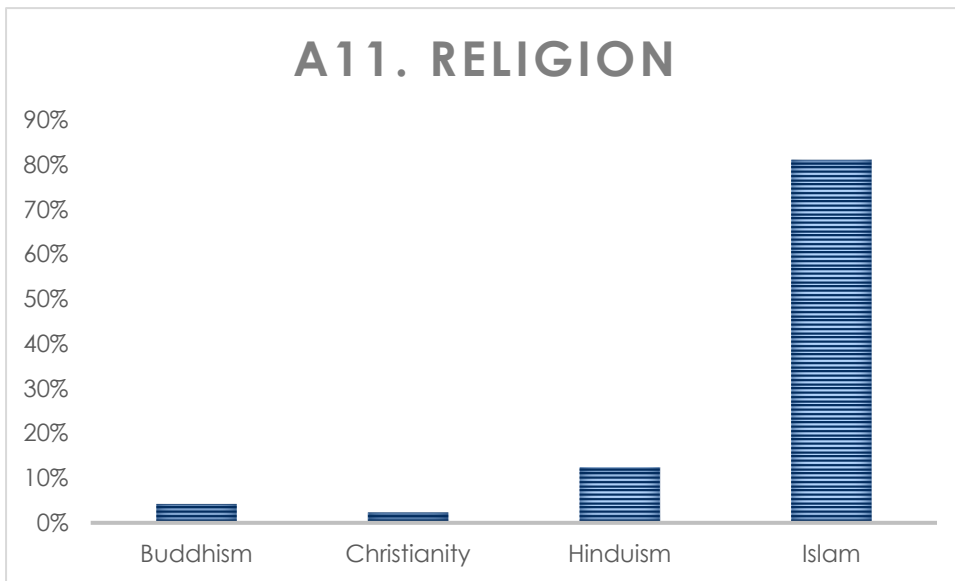
#### A10. Education



Primary school	108	25%
Secondary school	104	24%
O' level	65	15%
Basic education (basic literacy)	50	12%
No education	39	9%
A' level	32	7%

Degree and above	19	4%
------------------	----	----

#### A11/A12. Religion



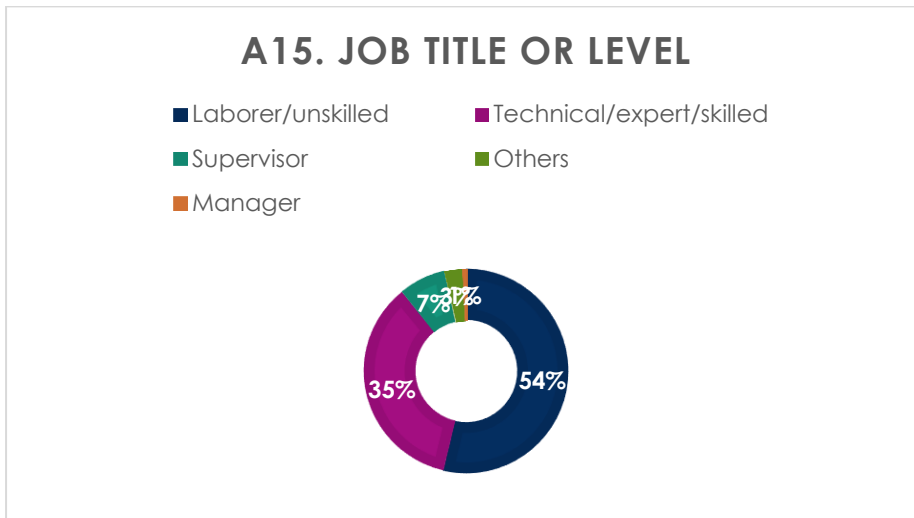
Buddhism	18	4%
Christianity	10	2%
Hinduism	54	12%
Islam	352	81%

#### A13/A14. Main Language used to communicate



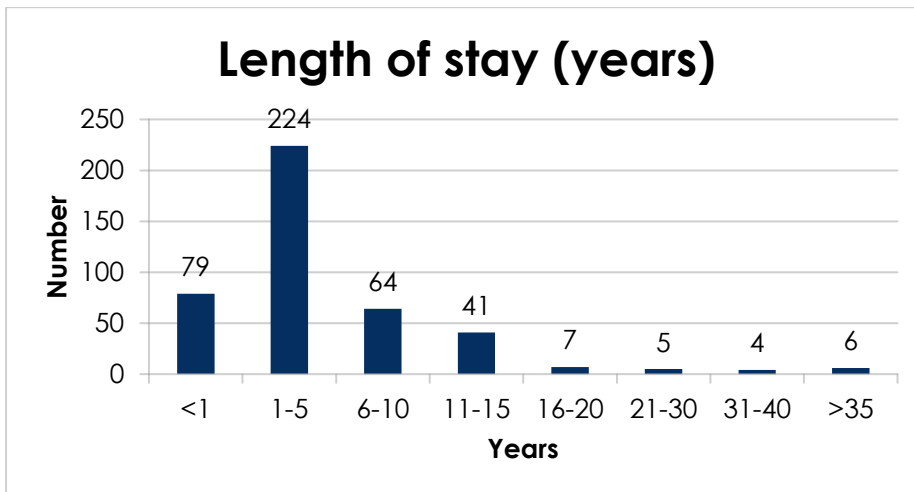
Bengali	239	55%
Dhivehi	127	29%
Hindhi	22	5%
Tamil	15	3%
English	13	3%
Nepali	9	2%
Sinhala	7	2%
Malayalam	1	0%

**A15. Job Title/ or Level**



Laborer/unskilled	233	54%
Technical/expert/skilled	154	35%
Supervisor	32	7%
Others	12	3%
Manager	3	1%

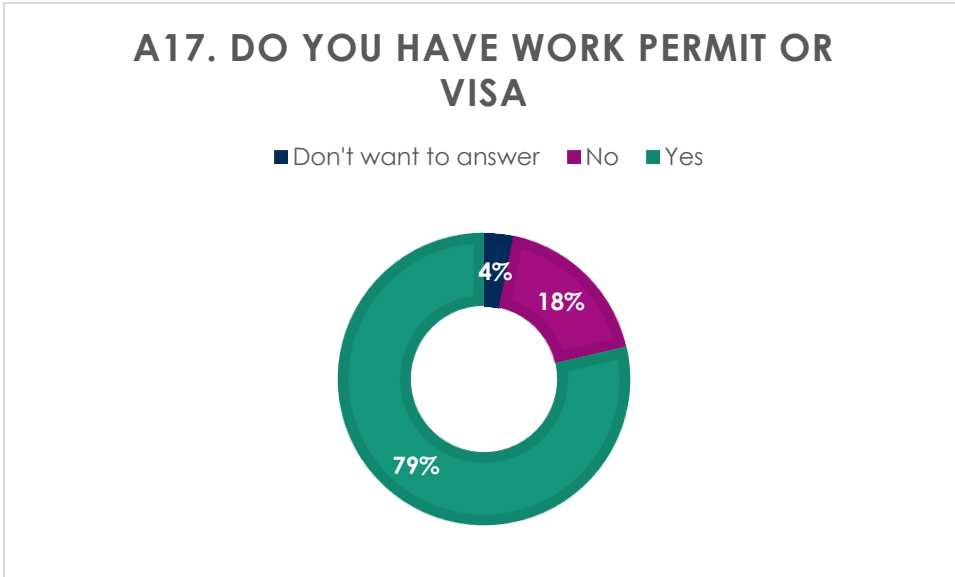
**A16. Length of Stay**



Length of stay (years)	Count
<1	79
1-5	224
6-10	64
11-15	41
16-20	7
21-30	5
31-40	4

>35	6
	430

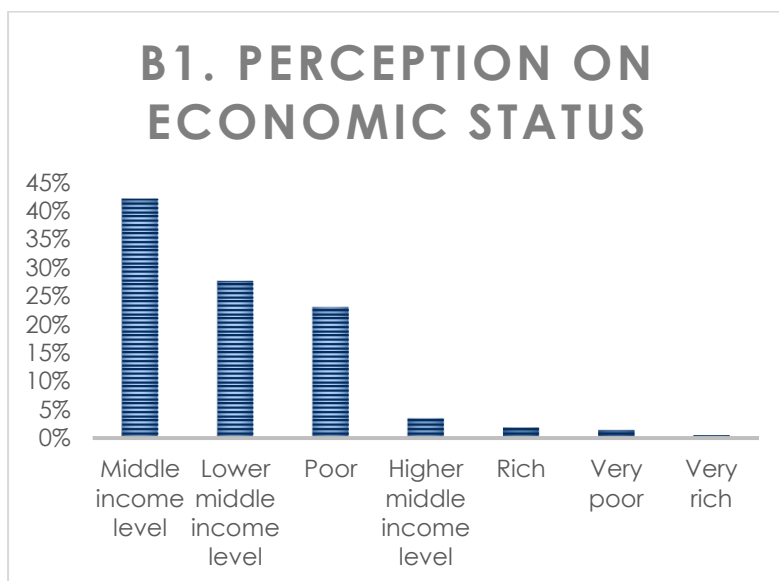
**A17. Do you have a work permit?**



Don't want to answer	15	4%
No	78	18%
Yes	337	78%

## B. INCOME, EXPENDITURE AND SAVINGS

### B1. Perception on Economic status



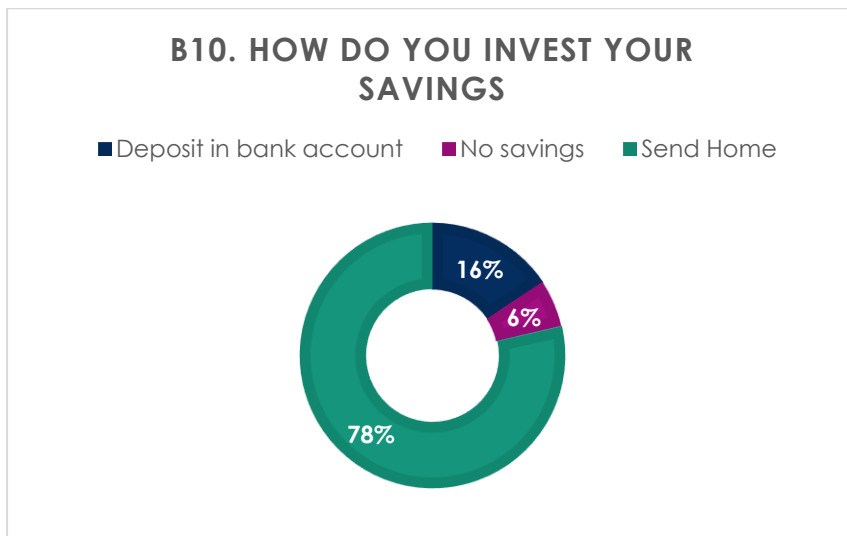
Middle income level	183	42%
Lower middle income level	120	28%
Poor	100	23%
Higher middle income level	15	3%
Rich	8	2%
Very poor	6	1%
Very rich	2	0%

### B2/B3/B4/B4/B6/B7/B8. Estimated monthly expenditure

Expenditure (MVR)	Number of people who spent on:						
	B2. Food & Drinks	B3. House Rent	B4. House Maintenance	B5. Healthcare	B6. Electricity	B7. Water	B8. Communication
0-499	253	395	404	396	402	403	149
500-999	40	1	7	14	9	13	205
1000-1499	47	3	3	10	5	2	45
1500-1999	36	3	2	1	3	1	14
2000-2499	15	1	3	4	5	6	11
2500-2999	1	1	2	0	1	0	0
3000-3499	13	2	2	1	0	1	2
3500-3999	2	1	1	0	0	2	0
4000-4499	5	1	1	0	1	1	2
Above 5000	18	22	5	4	4	1	2



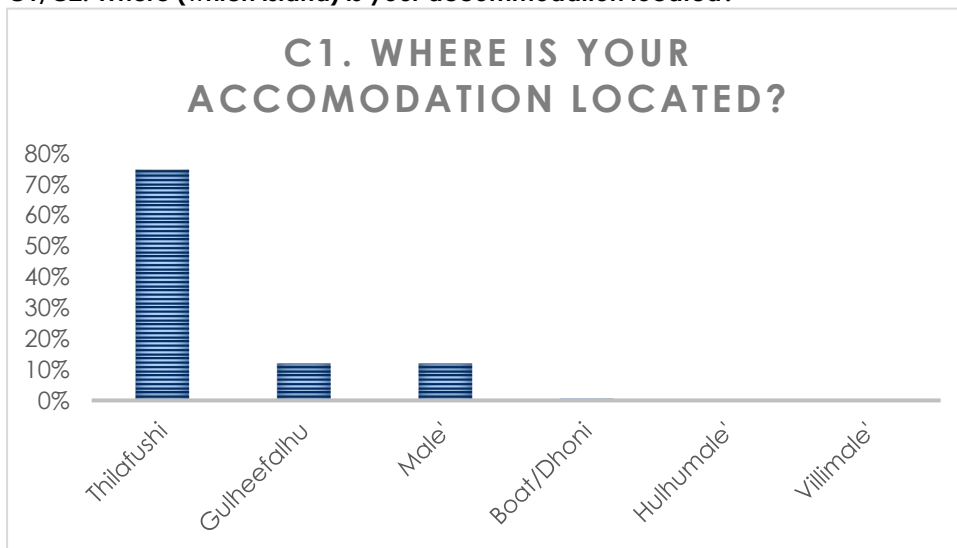
**B10. How do you invest your savings?**



Deposit in bank account	68	16%
No savings	25	6%
Send Home	341	78%

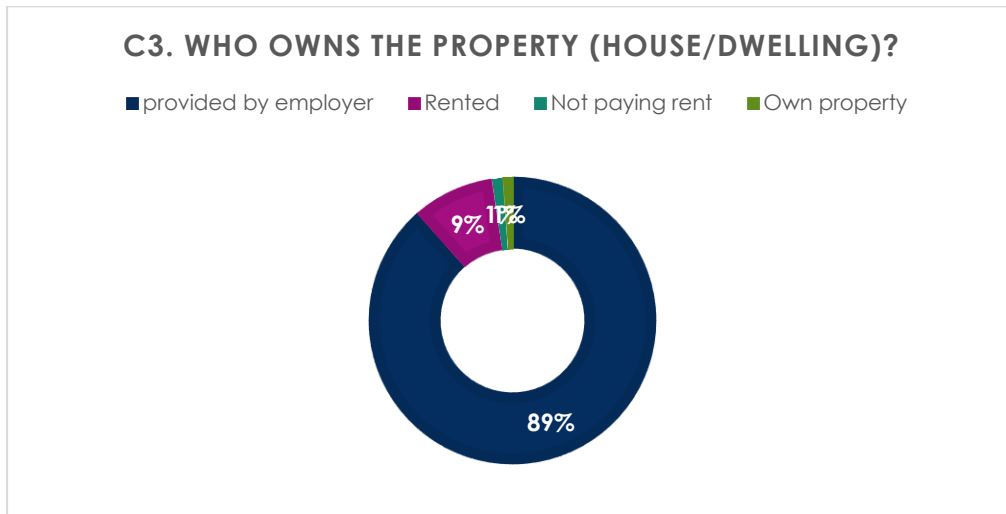
**C. HOUSING, INFRASTRUCTURE AND BASIC SERVICES**

**C1/C2. Where (which island) is your accommodation located?**



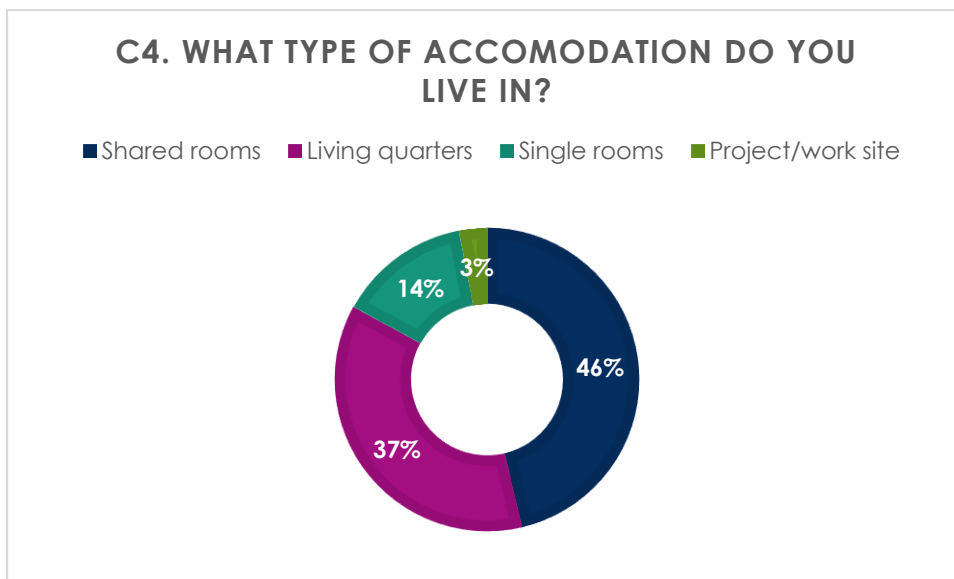
Thilafushi	320	74%
Gulheefalhu	52	12%
Male'	52	12%
Boat/Dhoni	3	1%
Hulhumale'	2	0.47%
Villimale'	1	0.23%

**C3. Who owns the property (House/dwelling)?**



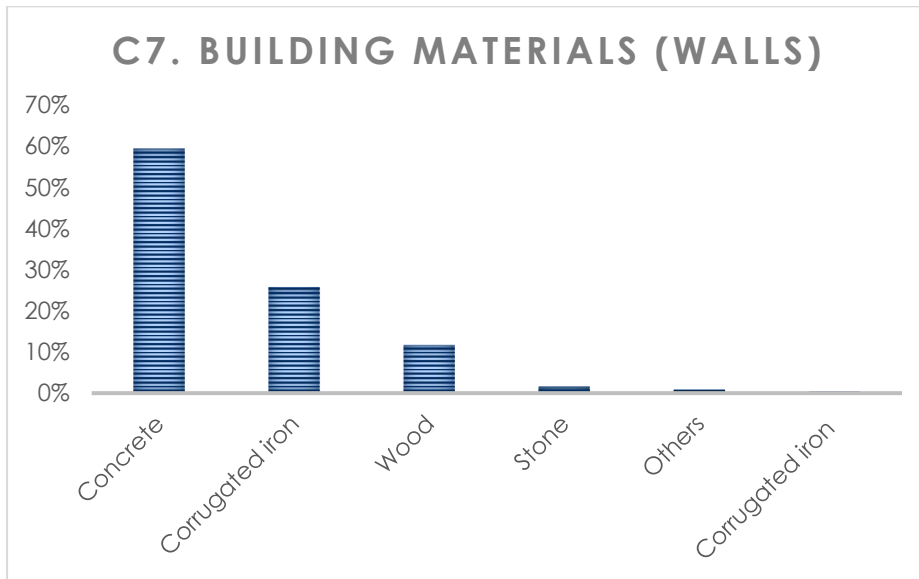
provided by employer	384	88%
Rented	40	9%
Not paying rent	5	1%
Own property	5	1%

**C4. What type of accommodation do you live in?**



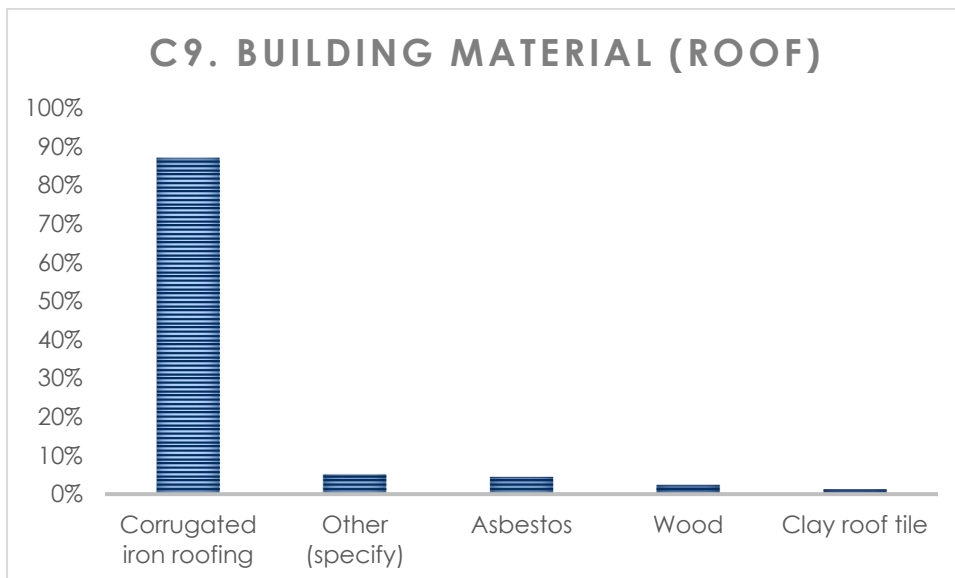
Shared rooms	201	46%
Living quarters	159	37%
Single rooms	61	14%
Project/work site	13	3%

**C7/C8. Building material (Walls)**



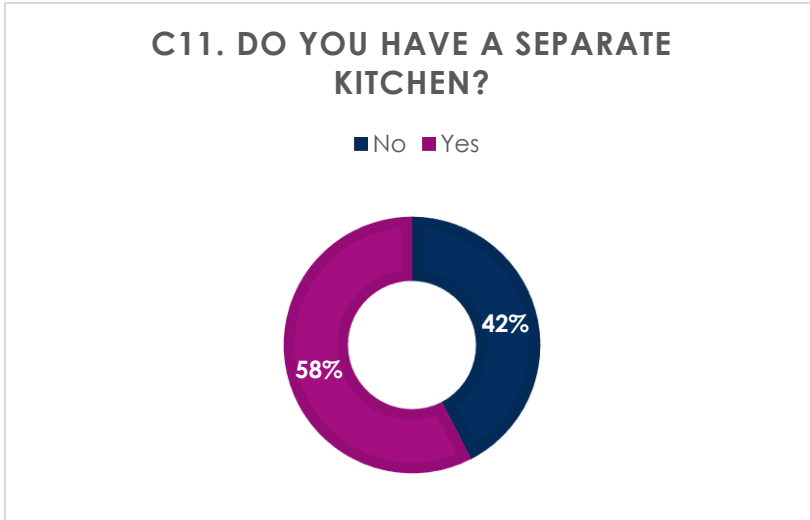
Concrete	258	60%
Corrugated iron	108	25%
Wood	51	12%
Stone	7	2%
Others	4	1%
Corrugated iron	2	0%

**C9/C10. Building material (Roof)**



Corrugated iron roofing	378	87%
Other (specify)	22	5%
Asbestos	19	4%
Wood	10	2%
Clay roof tile	5	1%

**C11. Do you have a Separate kitchen?**



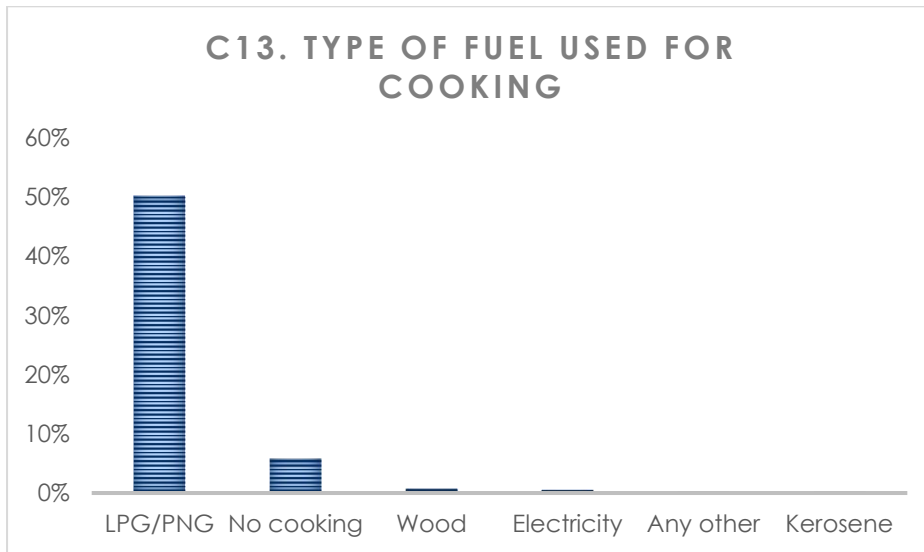
No	184	42%
Yes	250	58%

**C12. If yes, do you prepare your own food?**



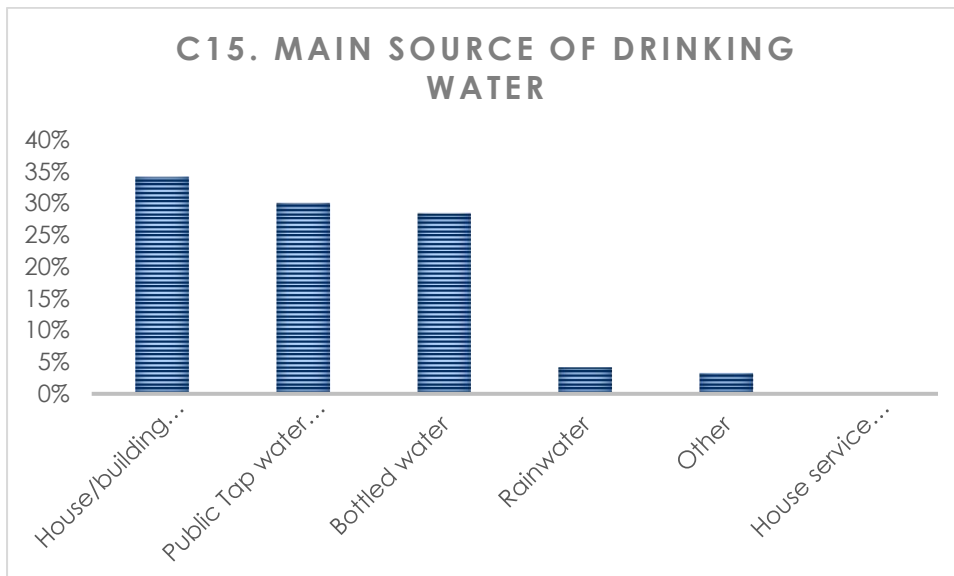
No	106	42%
Yes	144	58%

**C13/C14. What type of fuel is used for cooking?**



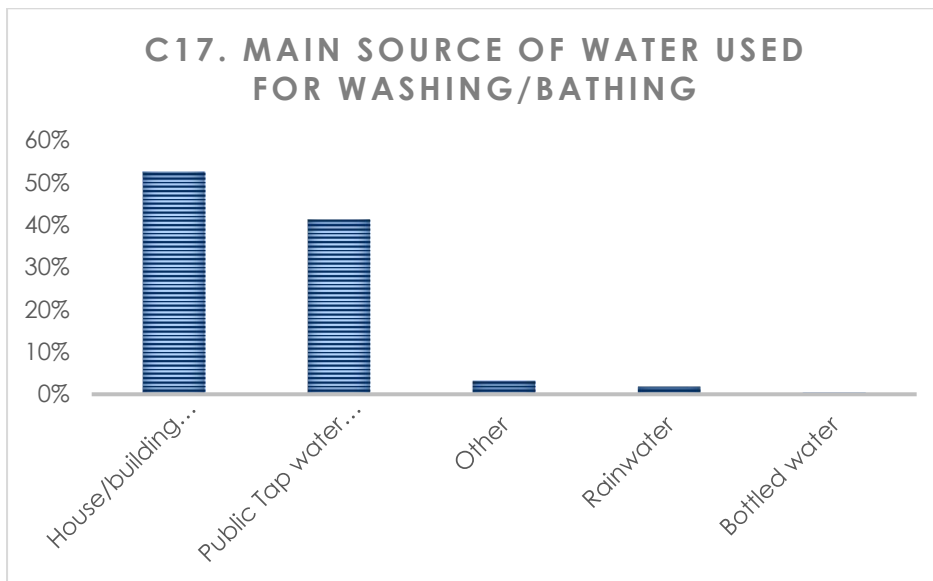
LPG/PNG	218	50%
No cooking	25	6%
Wood	3	1%
Electricity	2	0%
Any other	1	0%
Kerosene	1	0%

**C15/C16. Main source of drinking water**



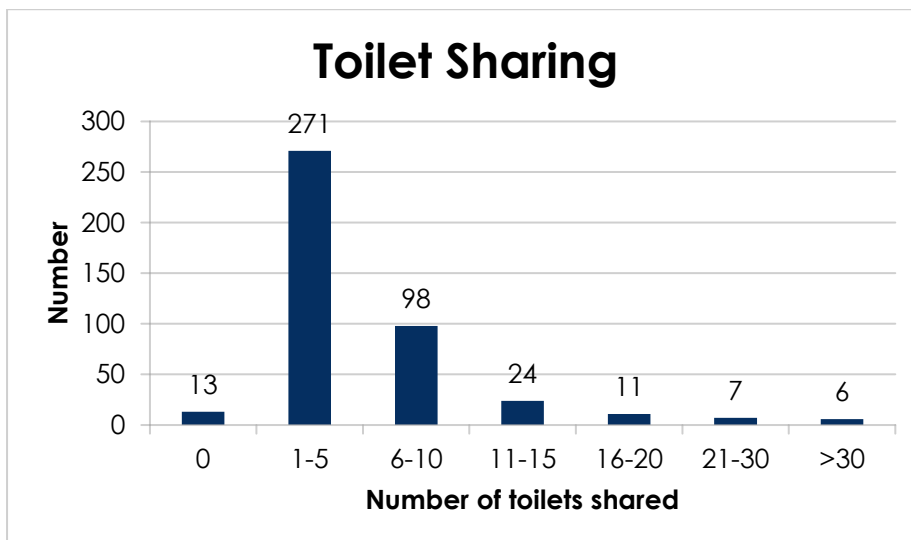
House/building service Connection	148	34%
Public Tap water from treated source	130	30%
Bottled water	123	28%
Rainwater	18	4%
Other	14	3%
House service Connection	1	0%

**C17/C18. Main source of water used for washing/ bathing**



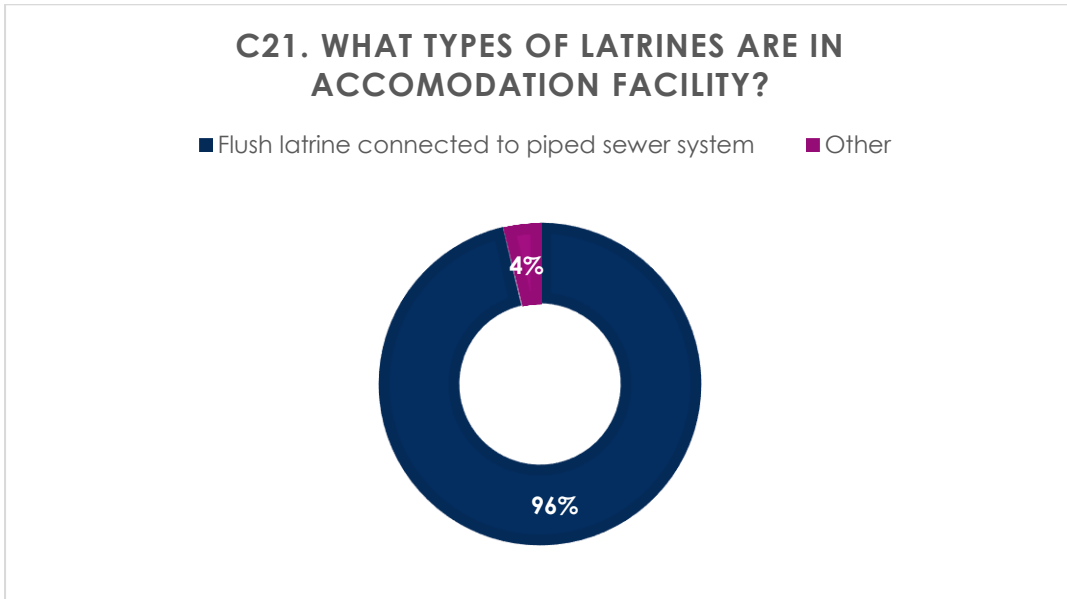
House/building service Connection	228	53%
Public Tap water from treated source	179	41%
Other	14	3%
Rainwater	8	2%
Bottled water	2	0%

**C20. Number of toilets shared**



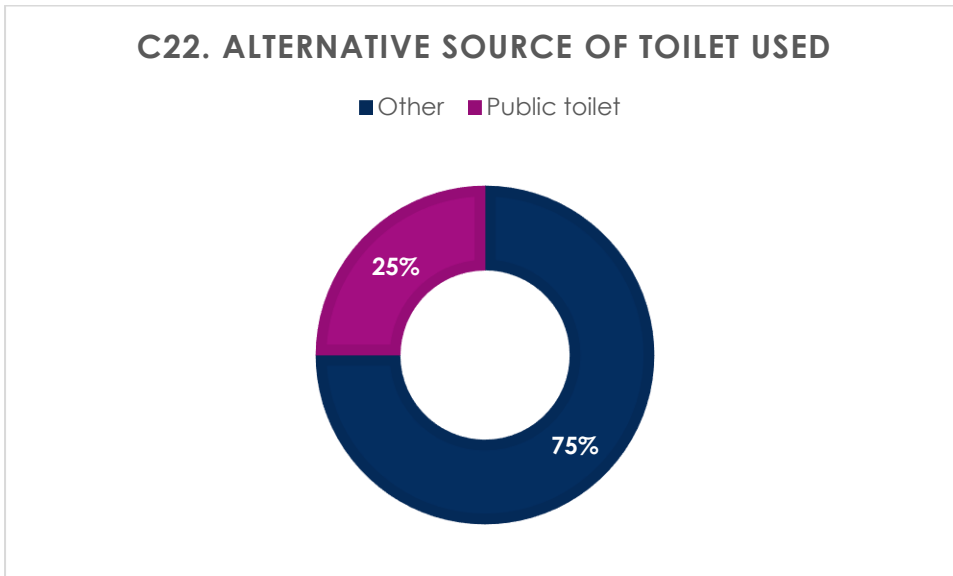
Number of toilets shared	Count
0	13
1-5	271
6-10	98
11-15	24
16-20	11
21-30	7
>30	6
	<b>430</b>

**C21. What Types of Latrines are in the accommodation facility?**



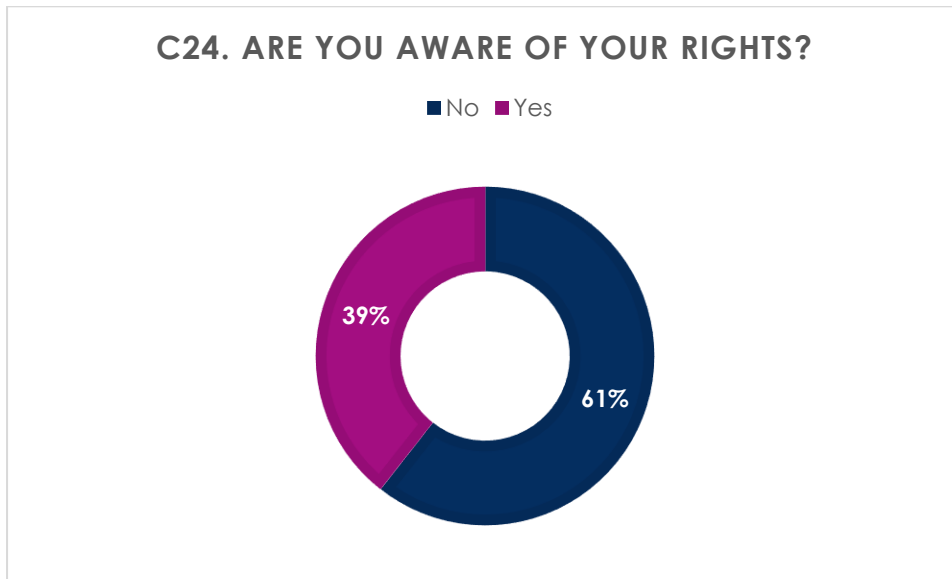
Flush latrine connected to piped sewer system	414	96%
Other	16	4%

**C22/C23. Alternate source of toilet used**



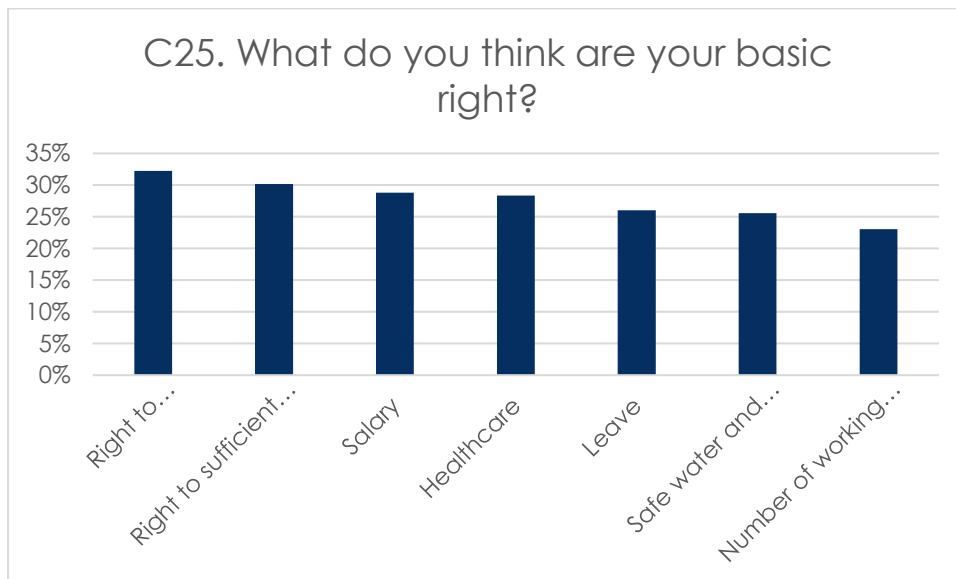
Other	15	83%
Public toilet	3	17%

**C24. Are you aware of your rights?**



No	263	61%
Yes	167	39%

**C25. What do you think are your basic rights?**

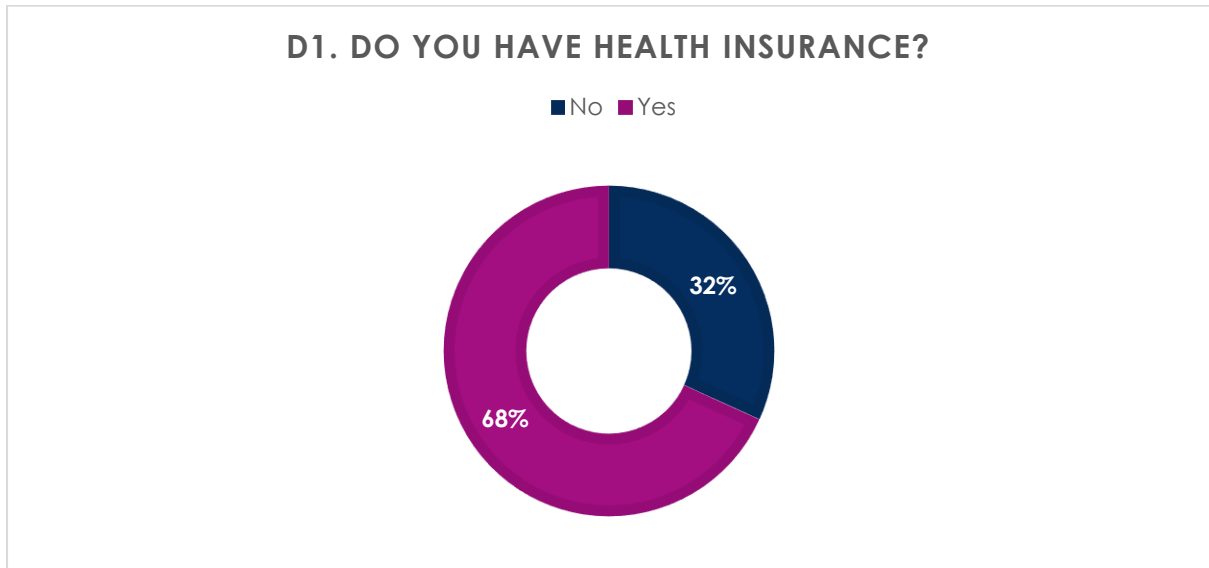


Right to accommodation	140	32%
Right to sufficient foods/meals	131	30%
Salary	125	29%
Healthcare	123	28%
Leave	113	26%
Safe water and sanitation	111	26%
Number of working hours	100	23%



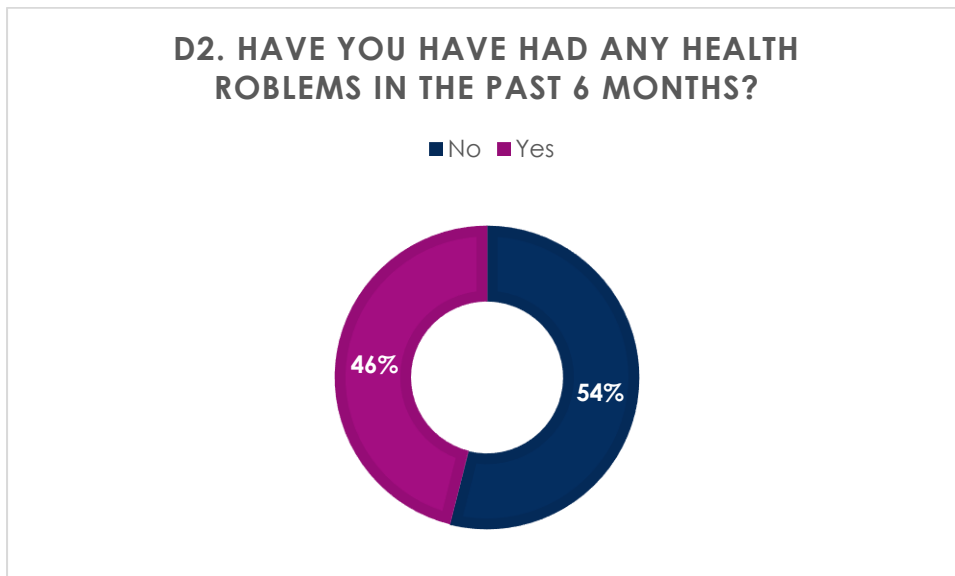
## D. HEALTH CONDITION AND HEALTH CARE SERVICES

D1. Do you have health insurance?



No	138	32%
Yes	296	68%

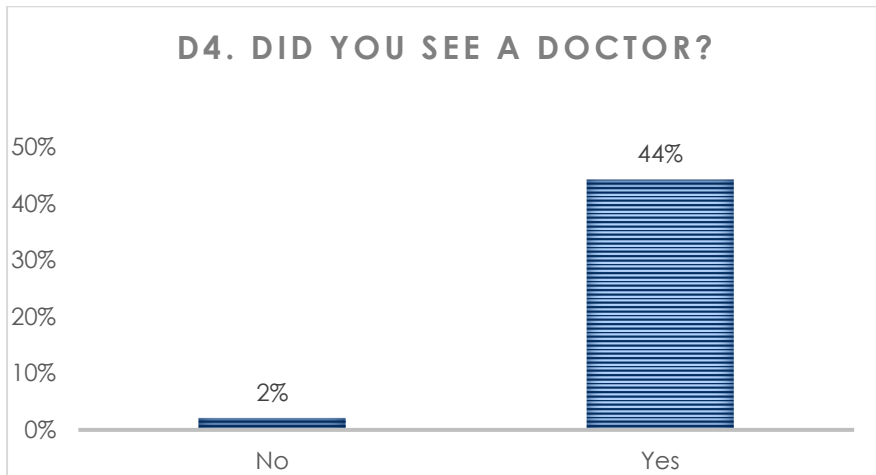
D2. Have you have had any health problems in the past 6 months?



No	234	54%
Yes	200	46%

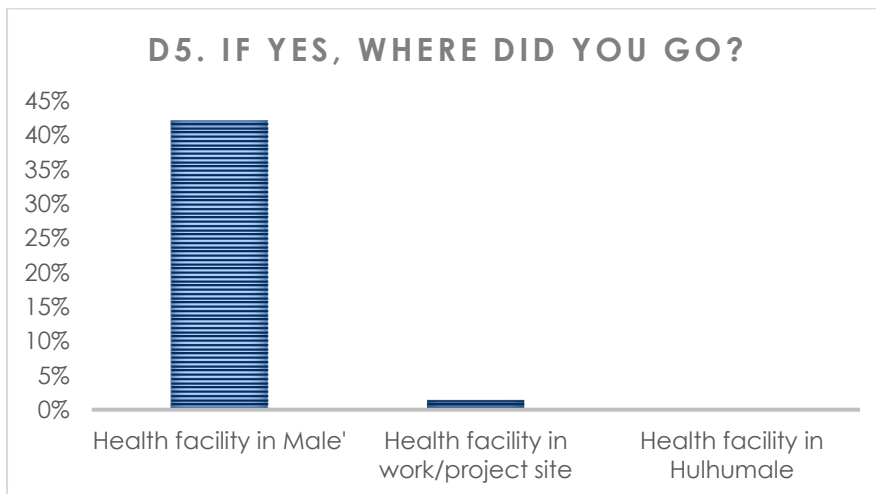


**D4. Did you see a doctor?**



No	9	2%
Yes	192	44%

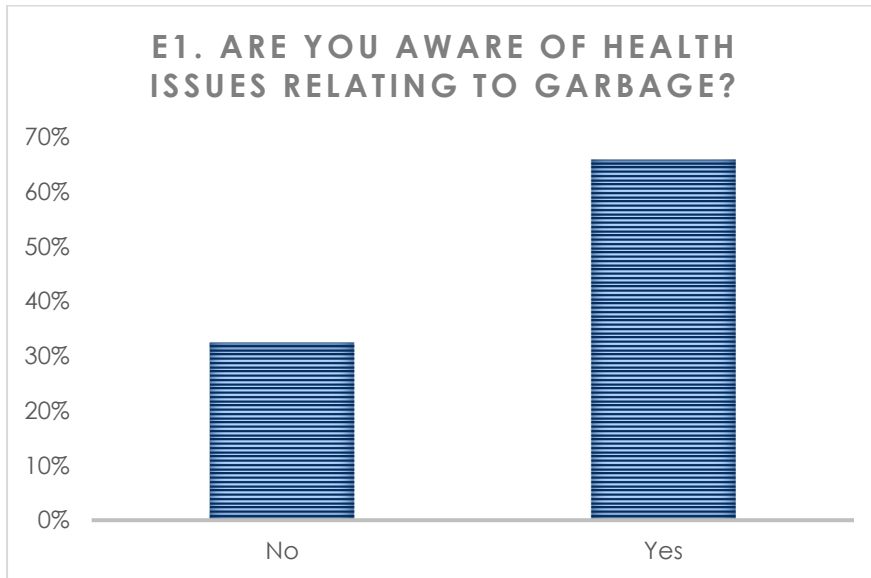
**D5. If yes, where did you go?**



Health facility in Male'	183	42%
Health facility in work/project site	6	1%
Health facility in Hulhumale	1	0%

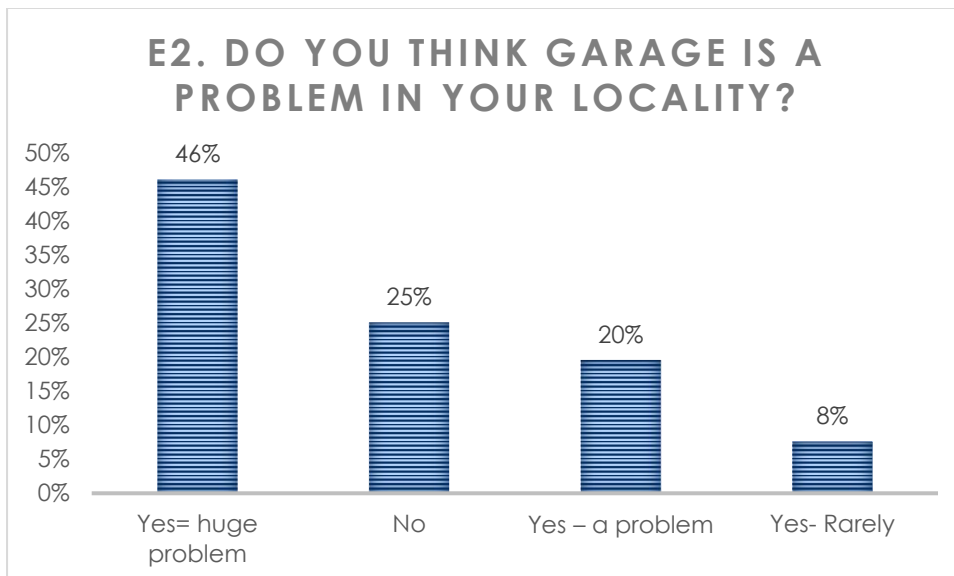
## E. SOLID WASTE MANAGEMENT

E1. Are you aware of any health issues relating to garbage/ waste management?



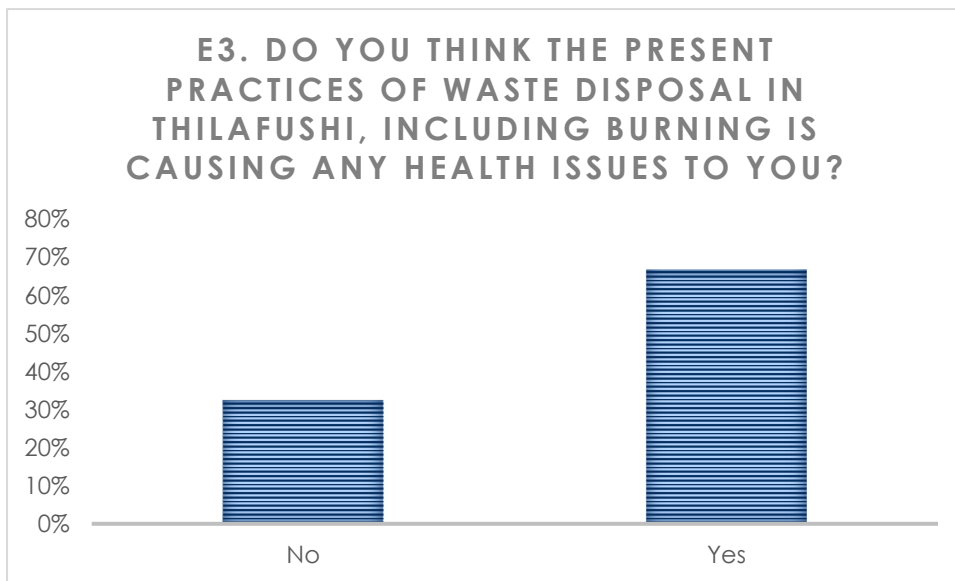
No	141	32%
Yes	286	66%
(blank)	7	2%

E2. Do you think garbage is a problem in your locality?



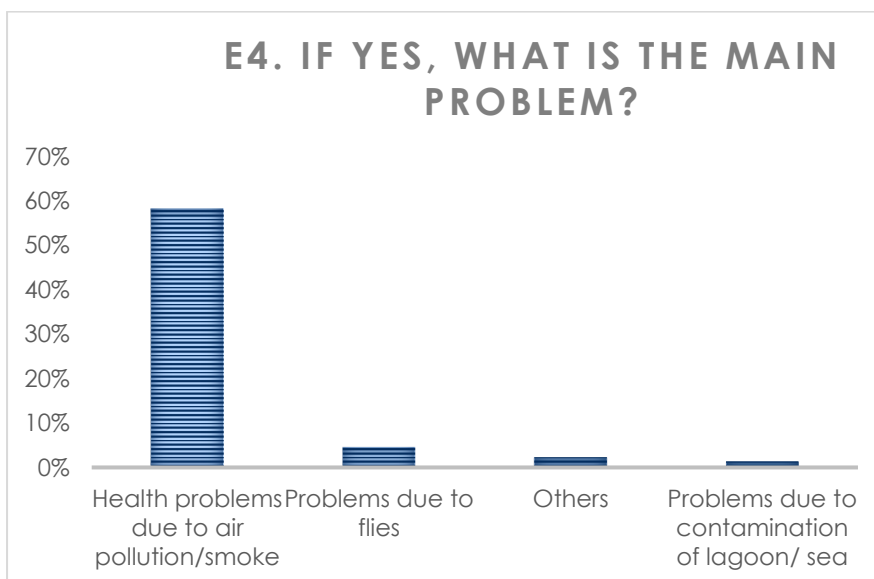
Yes= huge problem	200	46%
No	109	25%
Yes - a problem	85	20%
Yes- Rarely	33	8%
(blank)	7	2%

**E3. Do you think the present practices of waste disposal in Thilafushi, including burning is causing any health issues to you?**



No	141	32%
Yes	290	67%
(blank)	3	1%

**E4/E5. If yes, what are the problems?**



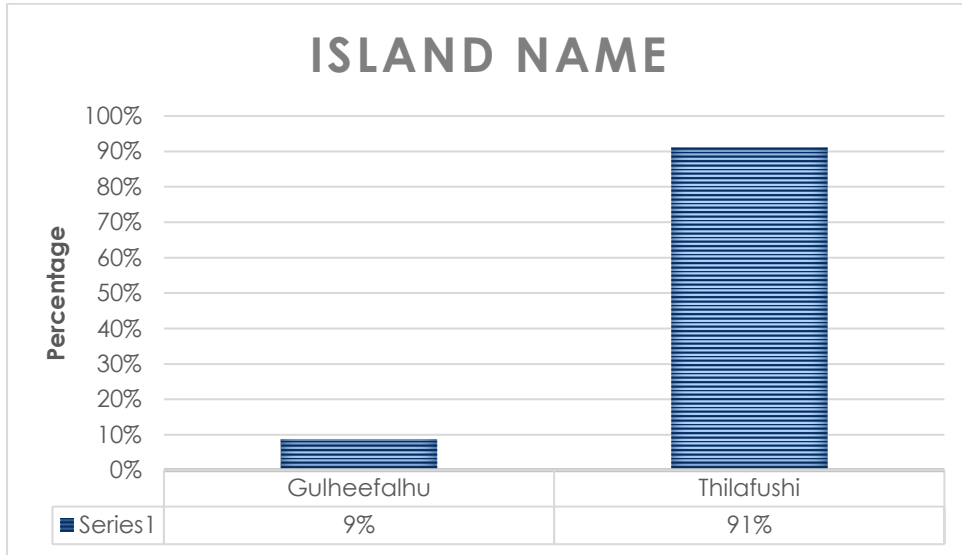
Health problems due to air pollution/smoke	253	58%
Problems due to flies	20	5%
Others	10	2%
Problems due to contamination of lagoon/ sea	6	1%
(blank)	145	33%

**APPENDIX E: Graphical representation of data obtained from company survey**

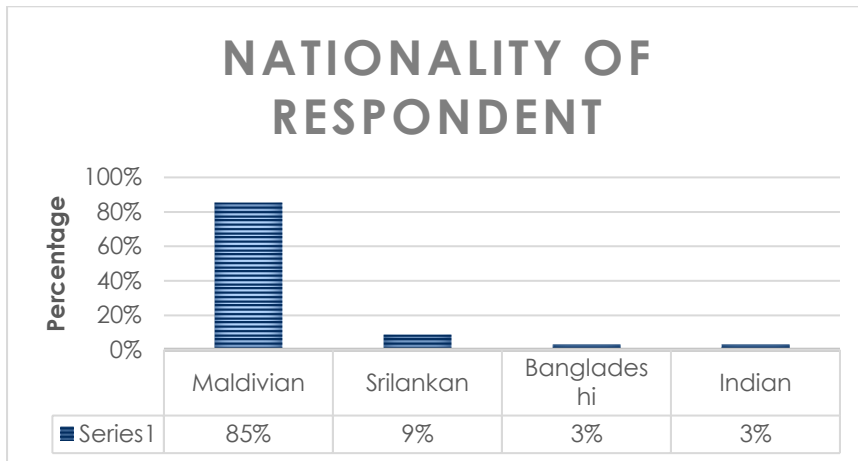
**DATA AND GRAPHS – COMPANY SURVEY**

**A. GENERAL INFORMATION**

**A2. Island Name**



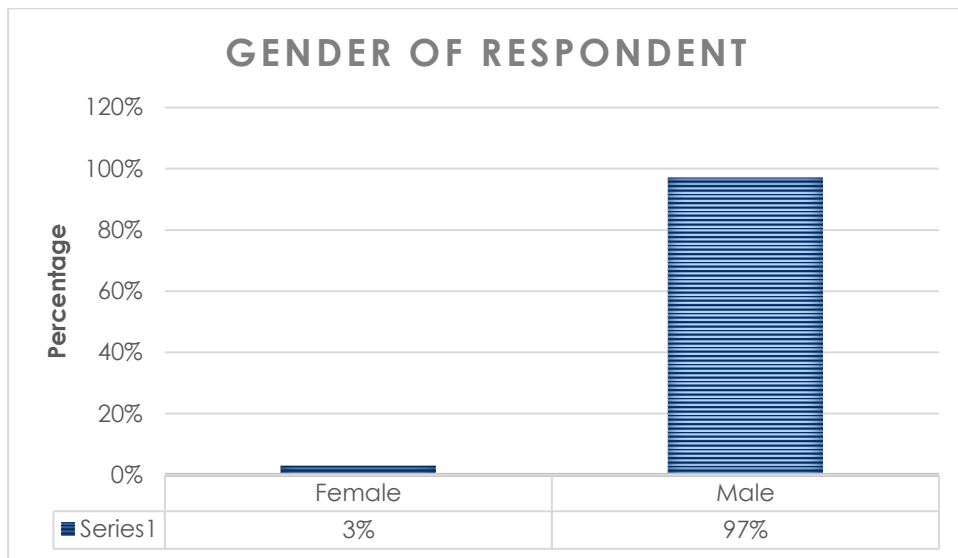
**A3 & A4 Nationality (of respondent)**



**A5. Name of Respondent**

(Data not to be disclosed)

### A6. Gender (of respondent)

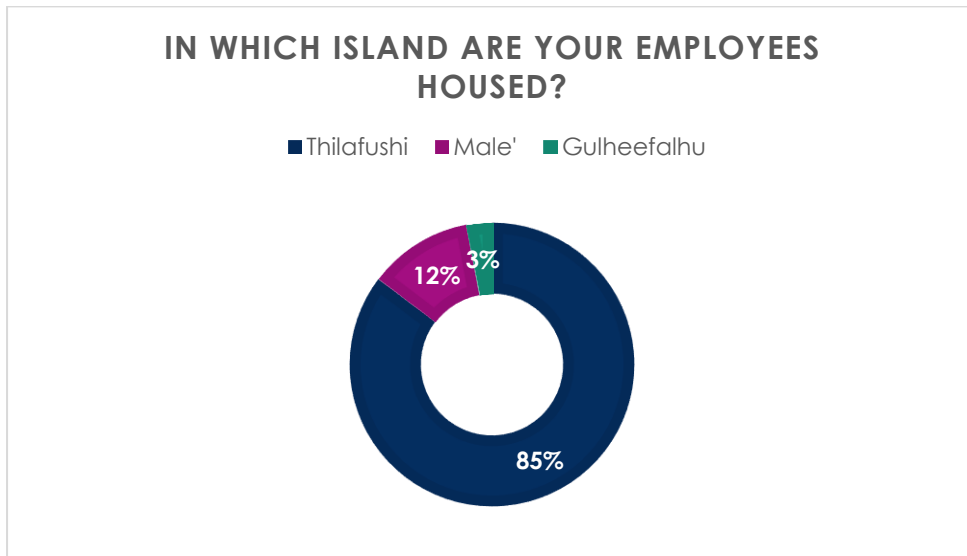


## A7, A8 and A9. Company Name, Key Activities and Total Number of Employees

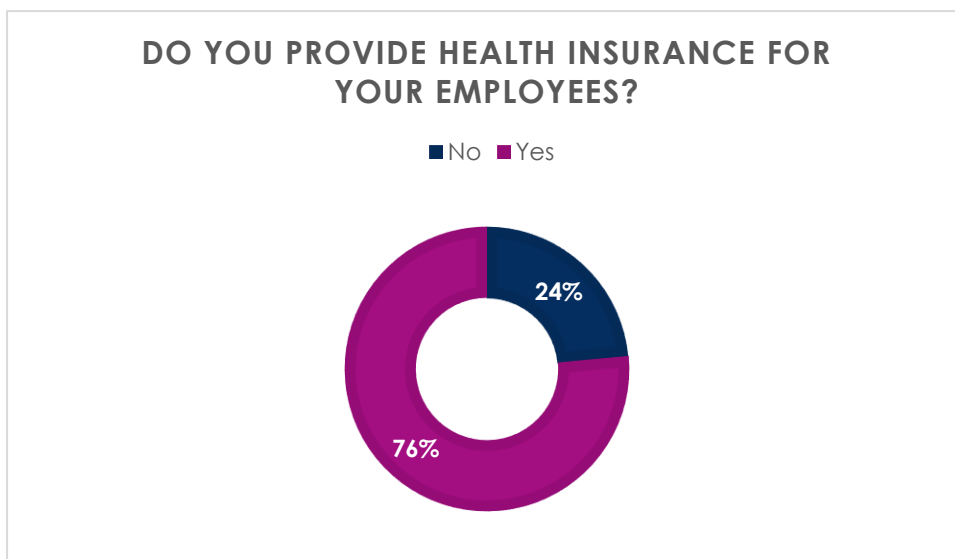
#	A2. Island Name	A7. Company Name	A8. What are the key Activities conducted by the company?	A9. Number of employees?	Gender
1	Thilafushi	Villa Hakatha	Delivery, gas, cement petrol and diesel	130	men
2	Thilafushi	Villa Hakatha F n B	Food and Beverage services, restaurant services	24	men
3	Thilafushi	Batch construction PVT LTD	Warehouse, storing metal, wood and electrical supplies	15	men
4	Thilafushi	Wheel pvt ltd	Leasing tugboats, excavators etc., Repairing and maintenance of vehicles and vessels, Taking projects such as land reclamation	10	men
5	Thilafushi	Mtcc	Warehouse and slipway, boat building and boat repair	180	men
6	Thilafushi	IZ	Workshop	No information	
7	Thilafushi	Eve garment	All works allowed in Thilafushi	No information	
8	Thilafushi	Leo trading	In Thilafushi they have mechanical and technical staff as the main work done there is the maintenance of assets such as landing craft, excavators etc.	47	men
9	Thilafushi	Sony hardware	Warehouse, storing and packaging	200	men
10	Thilafushi	Lafarge Maldives	Cement Factory	No information	
11	Thilafushi	MALDIVE GAS	LPG filling	29	men
12	Thilafushi	WAMCO	Solid waste management services, conduct clean up programs	150	men
13	Thilafushi	Mpl thilafushi	Boat building and boat repair, vehicle garage	35	men
14	Thilafushi	Dhamas	warehouse and workshop, vehicle repair and garage, warehouse	No information	
15	Thilafushi	Nalahiya trahiya trading pvt ltd	Warehouse for constuction materials	200	men
16	Thilafushi	Maldives Structural Product MSP	manufacturing roofing products, corrugated iron sheets	15	men
17	Thilafushi	Raaje logistics pvt ltd	Logistics Work, Transportaion sea and land	33	men
18	Thilafushi	Leo Trade	Logistics work	33	men
19	Thilafushi	Sunfront	Repairing boats and logistics	25	men
20	Thilafushi	Static company (aqua reef)	Water plant and electrical work	19	men
21	Thilafushi	The Hawks	Oil supplier; boatyard for loading, unloading and repair; port harbour; workshop,	120	men
22	Thilafushi	Metco	Garage	5	men
23	Thilafushi	Thilafalhu cafe	Tea shop	7	men
24	Thilafushi	Heavy Force	Repair n maintenance of heavy vehicles, Precast Yard.	35	men
25	Thilafushi	Antrac (maldives petroleum	Heavy vehicles are rented out, sell diesel oil, have 3 landing crafts	28	men
26	Thilafushi	Gulf craft	Boat building n repair	130	1 woman
27	Thilafushi	Maldives police services	Serve and protect	25	men
28	Thilafushi	Best dives pvt ltd	Boat yard, engine repair	12	men
29	Thilafushi	Build Maldives Company	Ship Repair and maintenance	24	men
30	Gulheefalhu	Stelco	Provide electricity	6	men
31	Gulheefalhu	GMIZ	Manage all services related to tenants including municipal services such as road maintenance, land lease, and conflict resolution. Tree plantation to make the island green	35	men
32	Gulheefalhu	Litus	Storage and workshop	15	men
33	Thilafushi	Apollo	Loading and unloading cargo	230	men
34	Thilafushi	GMIZ	Tenants related all municipal service including road works; Conflict resolution; land leasing and monitoring	155	men



**A10. In which island are your employees housed?**



**A11. Do you provide health insurance for your employees?**

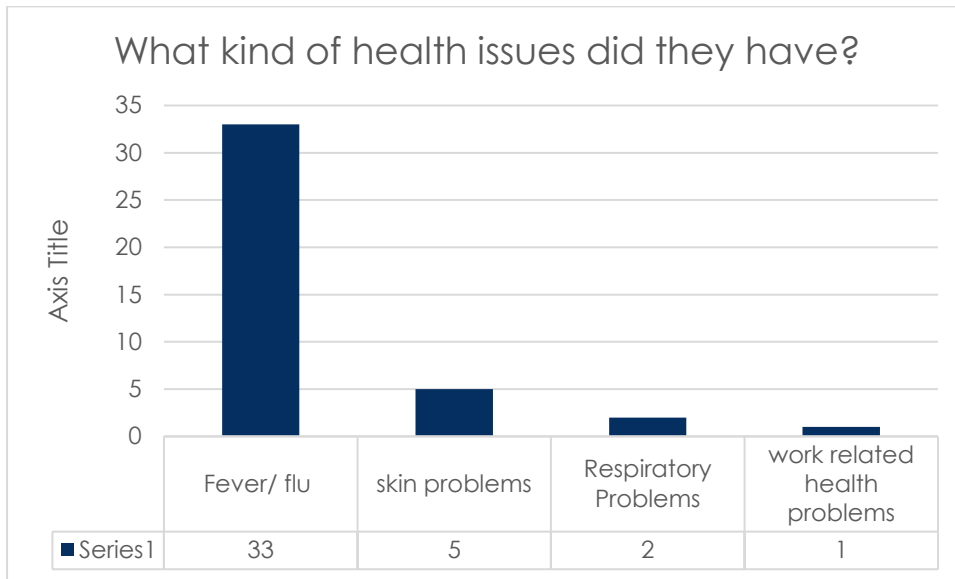


Note: Maldivian Nationals have access to the Government Health Insurance Scheme – Aasandha.

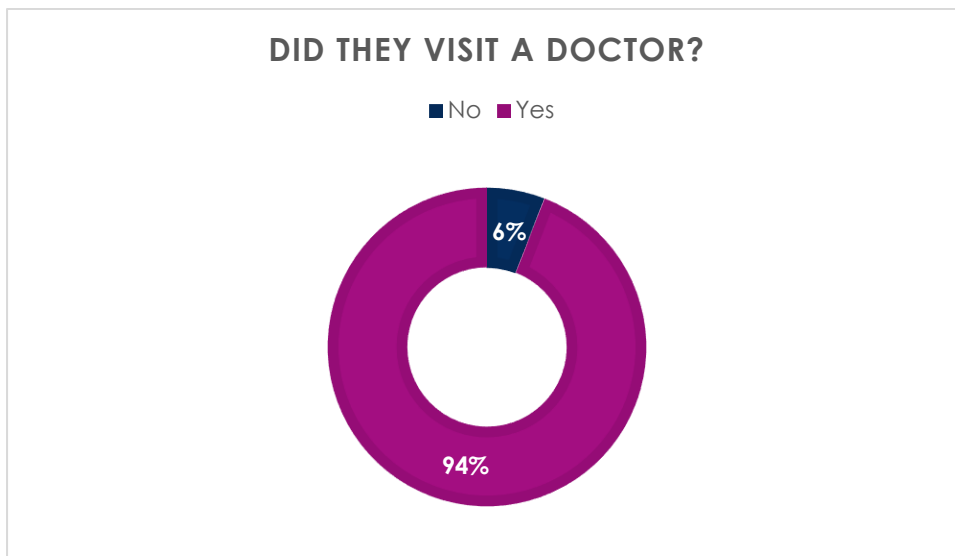
## A12. How many of your employees have reported sick in the past year?

	A2. Island Name	A7. Company Name	A9. Total number of employees?	A12. How many of your employees have reported sick in the past year?
1	Thilafushi	Villa Hakatha	130	60
2	Thilafushi	Villa Hakatha F n B	24	10
3	Thilafushi	Batch construction PVT LTD	15	1
4	Thilafushi	Wheel pvt ltd	10	25
5	Thilafushi	Mtcc	180	6
6	Thilafushi	IZ	no information provided	2
7	Thilafushi	Eve garment	no information provided	20
8	Thilafushi	Leo trading	47	10
9	Thilafushi	Sony hardware	200	60
10	Thilafushi	Lafarge Maldives	no information provided	2
11	Thilafushi	MALDIVE GAS	29	3
12	Thilafushi	WAMCO	150	25
13	Thilafushi	Mpl thilafushi	35	3
14	Thilafushi	Dhamas	no information provided	11
15	Thilafushi	Nalahiya trahiya trading pvt ltd	200	4
16	Thilafushi	Maldives Structural Product MSP	15	5
17	Thilafushi	Raajje logistics pvt ltd	33	5
18	Thilafushi	Leo Trade	33	25
19	Thilafushi	Sunfront	25	25
20	Thilafushi	Static company (aqua reef)	19	16
21	Thilafushi	The Hawks	120	36
22	Thilafushi	Metco	5	25
23	Thilafushi	Thilafalhu cafe	7	5
24	Thilafushi	Heavy Force	35	10
25	Thilafushi	Antrac (maldives petroleum	28	4
26	Thilafushi	Gulf craft	130	80
27	Thilafushi	Maldives police services	25	24
28	Thilafushi	Best dives pvt ltd	12	4
29	Thilafushi	Build Maldives Company	24	20
30	Gulheefalhu	Stelco	6	6
31	Gulheefalhu	GMIZ	35	10
32	Gulheefalhu	Litus	15	2
33	Thilafushi	Apollo	230	90
34	Thilafushi	GMIZ	155	60

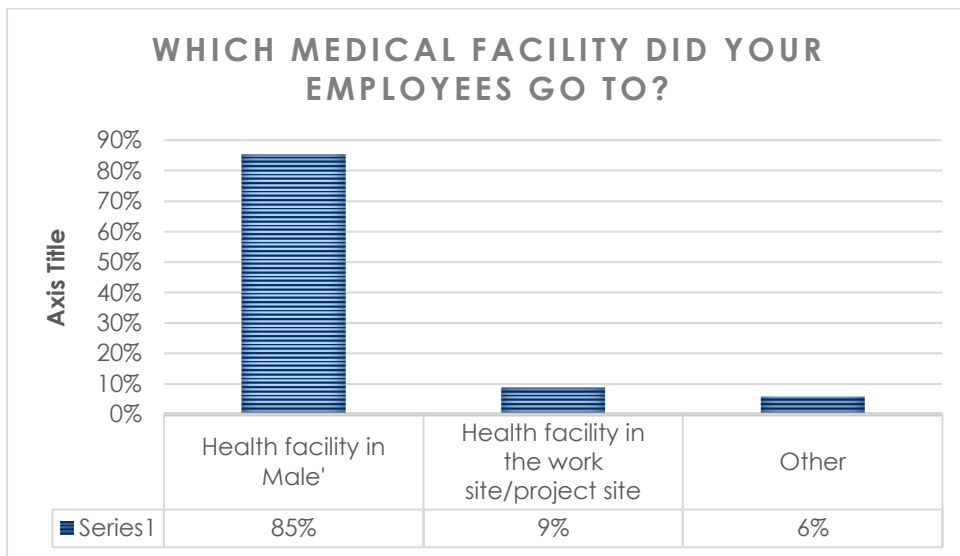
**A13. What kind of health issues did they have? (please provide a list if you have one)**



**A14. Did they visit a doctor?**



**A15. If yes to A14, Where did they go?**



**A16. What is the average annual cost for healthcare services for your employees? (in MVR)**

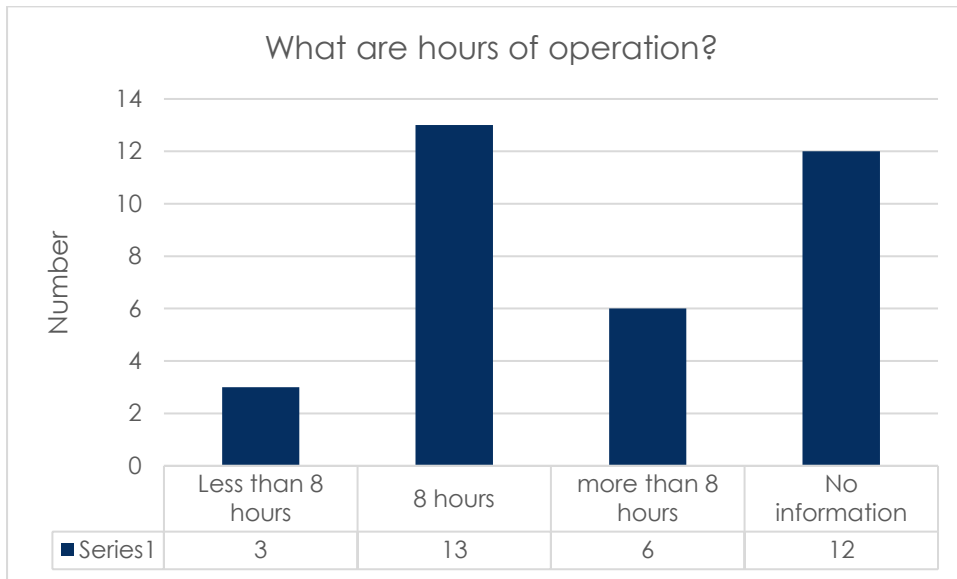
This information was provided by 8 companies.

	Island Name	Company Name	Annual cost for healthcare
1	Thilafushi	Wheel pvt ltd	45000
2	Thilafushi	Leo trading	300000 to 400000
3	Thilafushi	Sony hardware	400000
4	Thilafushi	MALDIVE GAS	66700
5	Thilafushi	Nalahiya trahiya trading pvt ltd	8400
6	Thilafushi	Maldives Structural Product MSP	8250
7	Thilafushi	Heavy Force	350000
8	Thilafushi	Antrac (maldives petroleum	28000 (company pays MVR1000 per person) employee pays MVR1000 (annually)

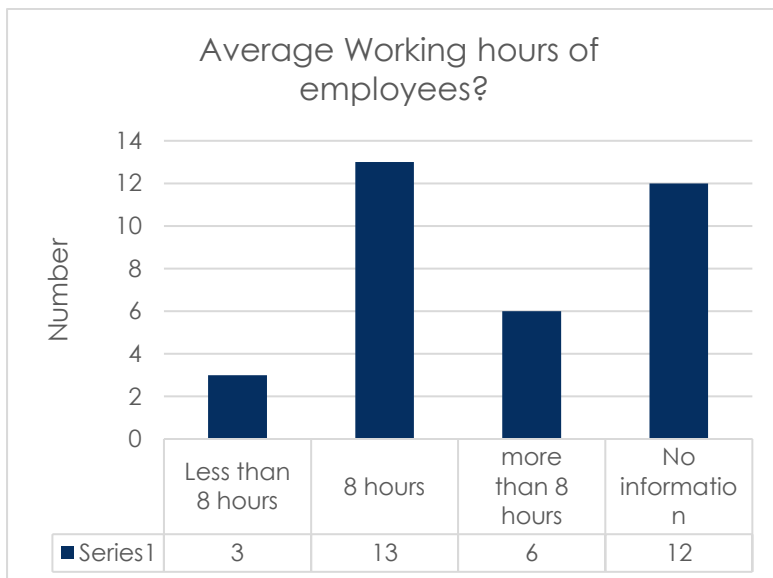
**A17. What are the range of salaries of your employees?**

None of the companies provided this information

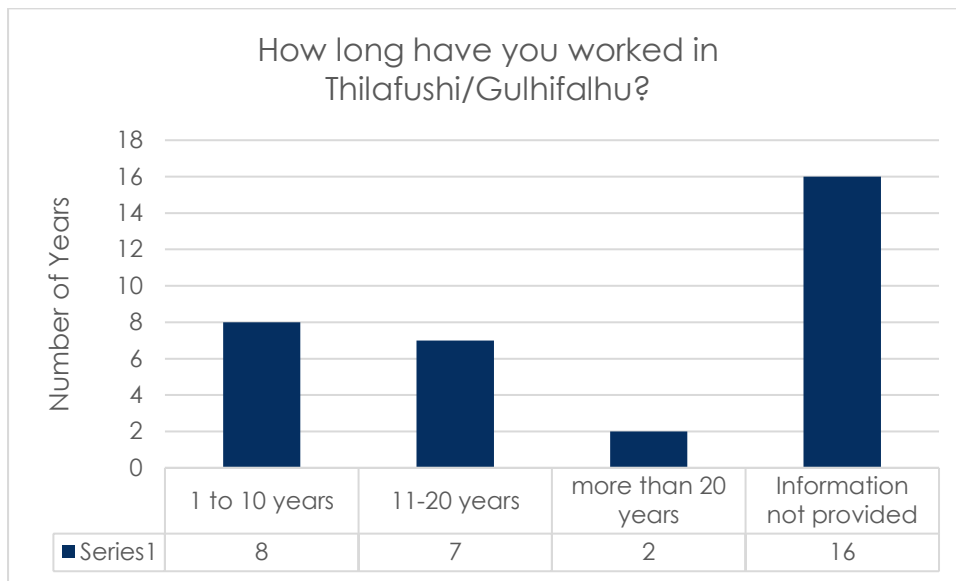
**A18. What are the hours of operation?**



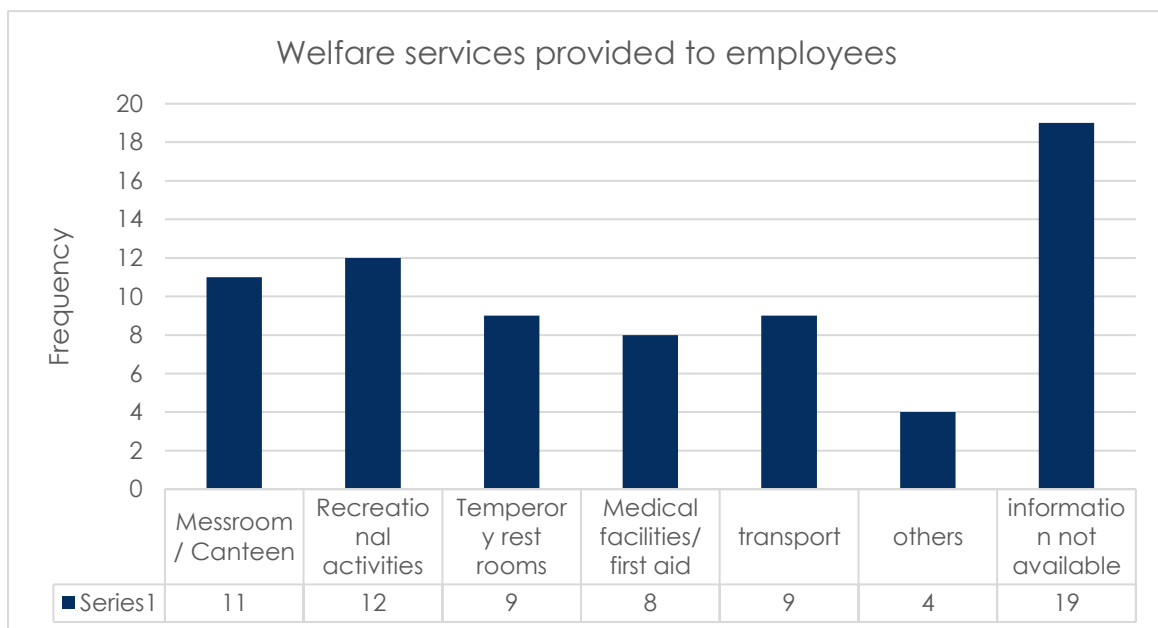
**A19. What are the average working hours of your employees?**



**A20. When did you start operations in Thilafushi/ Gulhifalhu?**



**A21. Specify the types of employee welfare facilities provided by your company**



**A22. Do you provide your employees with life insurance?**

None of the companies provide life insurance to their employees

**A23. Do you provide your employees with disability insurance?**

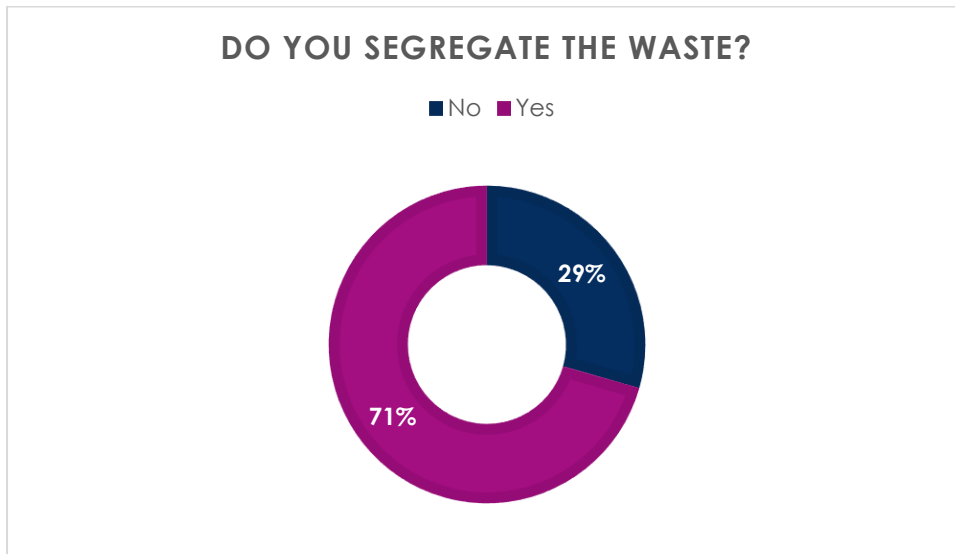
None of the companies provide disability insurance to their employees

**A24. What are the company's main assets? Can you provide details?**

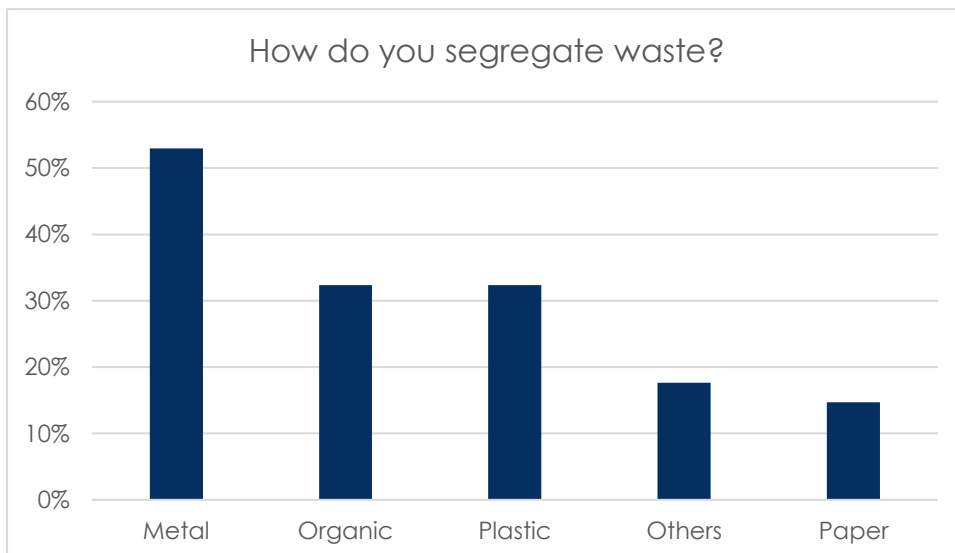
Only two companies provided details

## F. SOLID WASTE MANAGEMENT

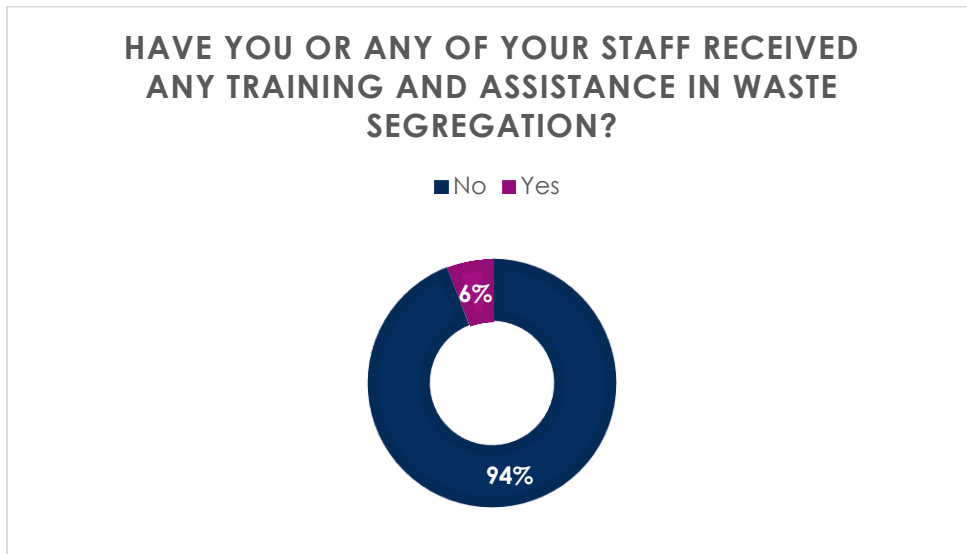
### B1. Do you segregate the waste?



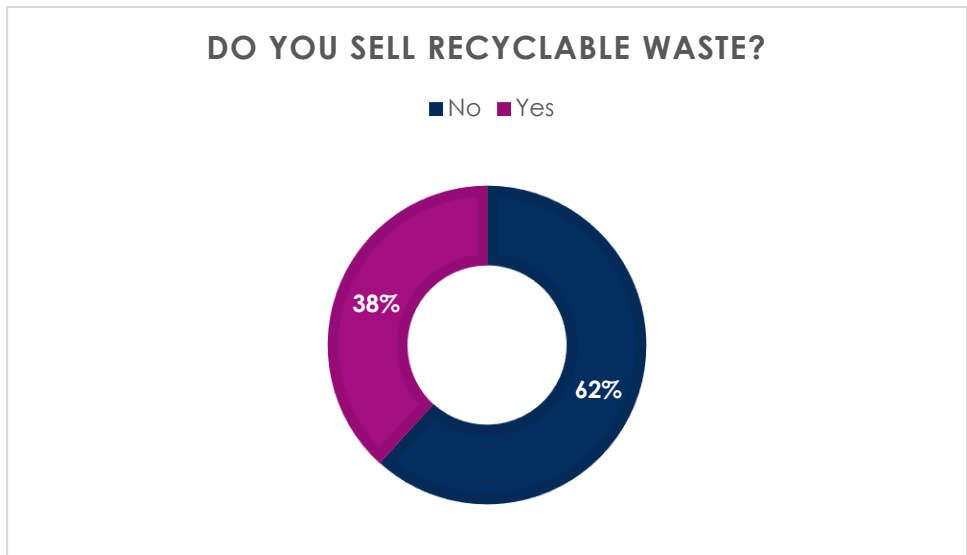
### B2 and B3 How do you segregate waste?



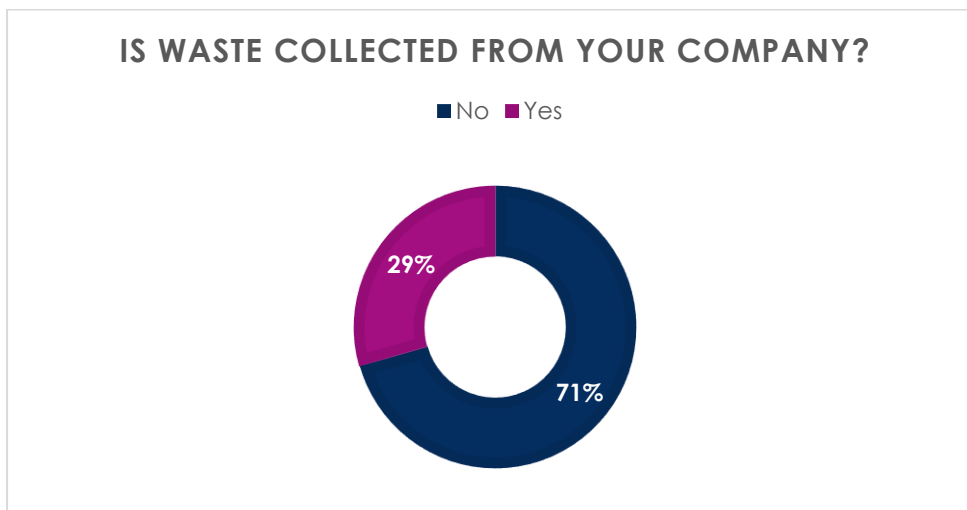
**B4. Have you received any training and assistance in waste segregation?**



**B6. Do you sell recyclable waste?**

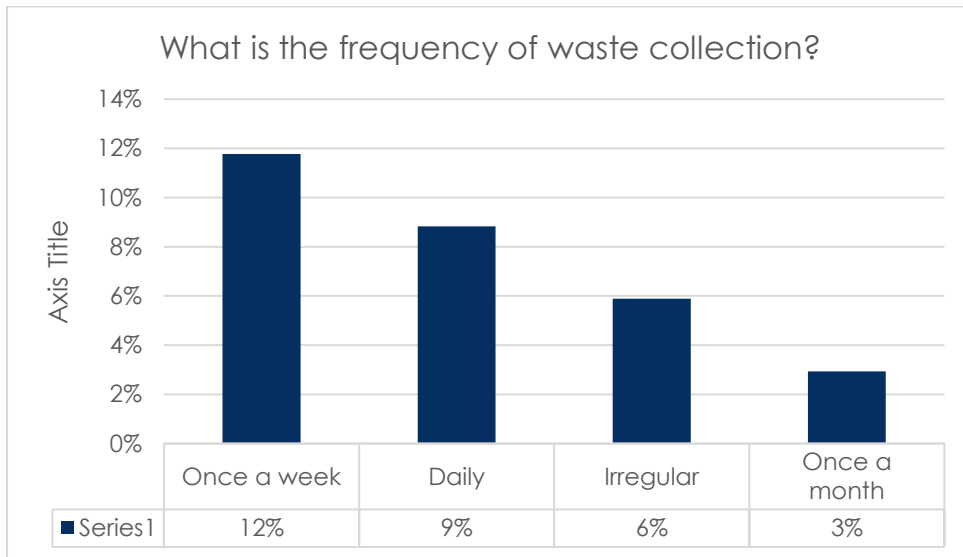


**B7. Is waste collection door to door/ from the company premises?**





**B8. If yes to B7, what is the frequency of waste collection?**



**B9 and B10. Who is responsible for waste collection?**



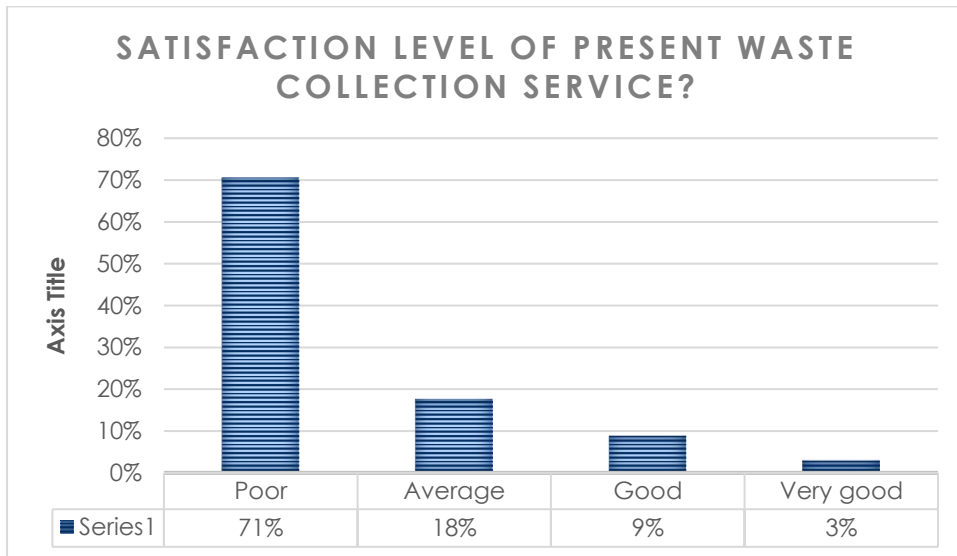
**B11. Do you pay for waste collection/ disposal service?**



**B12. How much do you pay for monthly waste collection (in MVR)**

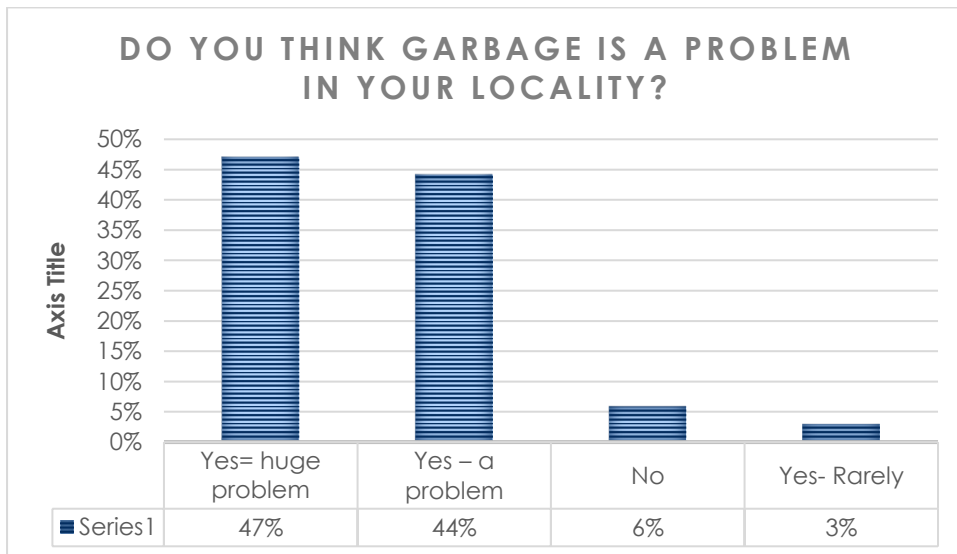
Amount in MVR	Sum of Count
(blank)	1
0-499	14
500-999	2
1000-1499	1
1500-1999	4
2000-2499	5
2500-2999	2
4000-4499	1
6000-6499	1
7000-7499	1
14000-14499	1
19000-19499	1
19500-20000	1
	35

**B13. Satisfaction level of present waste collection/ management service?**

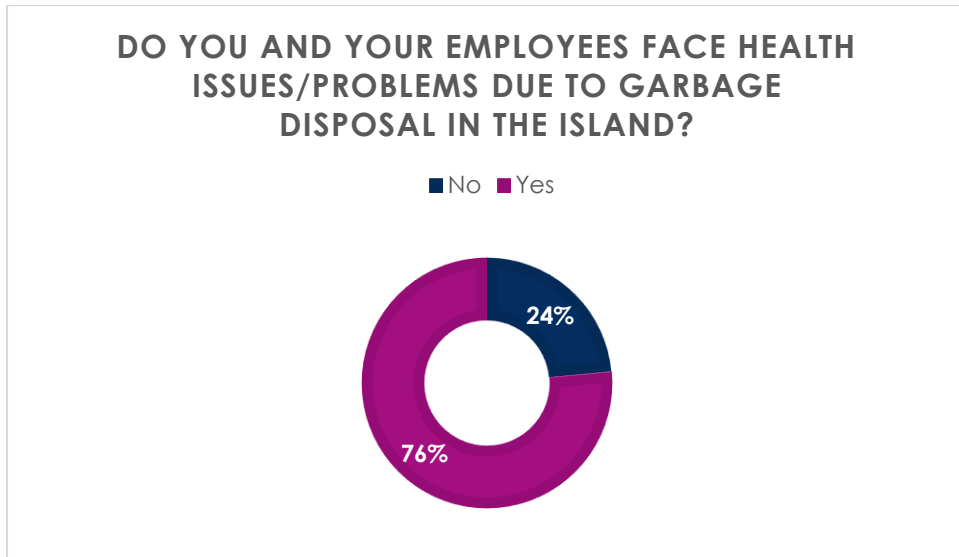


**B14. Do you feel the present monthly charge for waste collection is:**

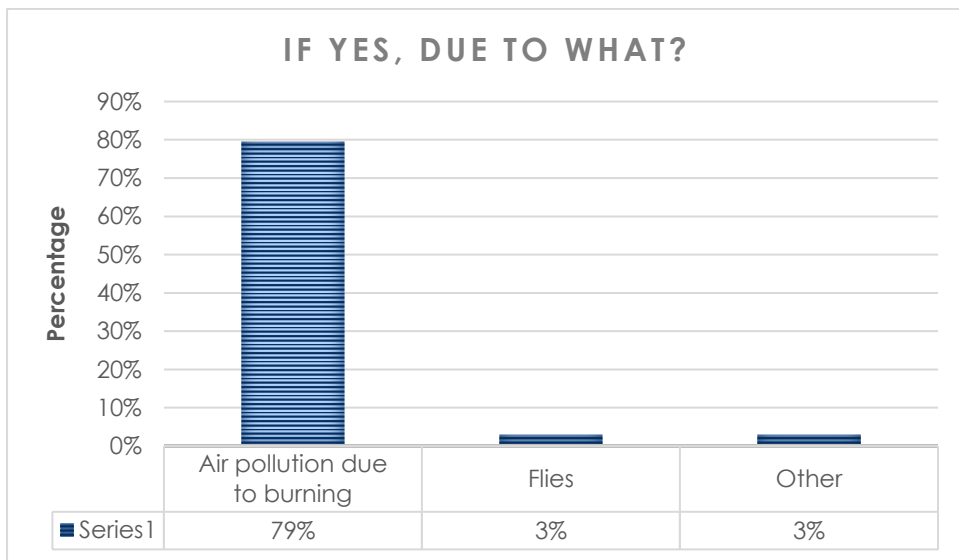
**B15. Do you think garbage is a problem in your locality?**



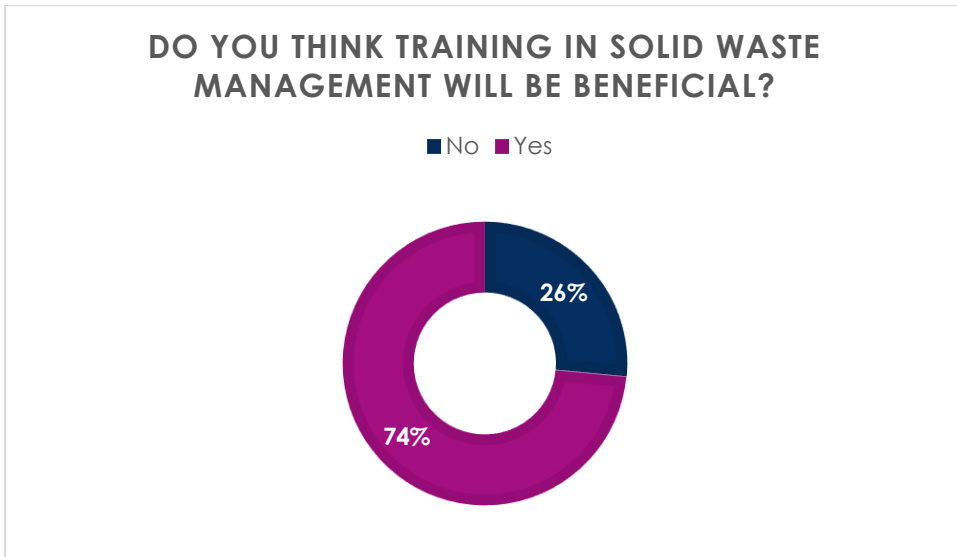
**B16 and B17. Do you and your employees face health problems/ issues due to the present practices of waste disposal in Thilafushi, including burning?**



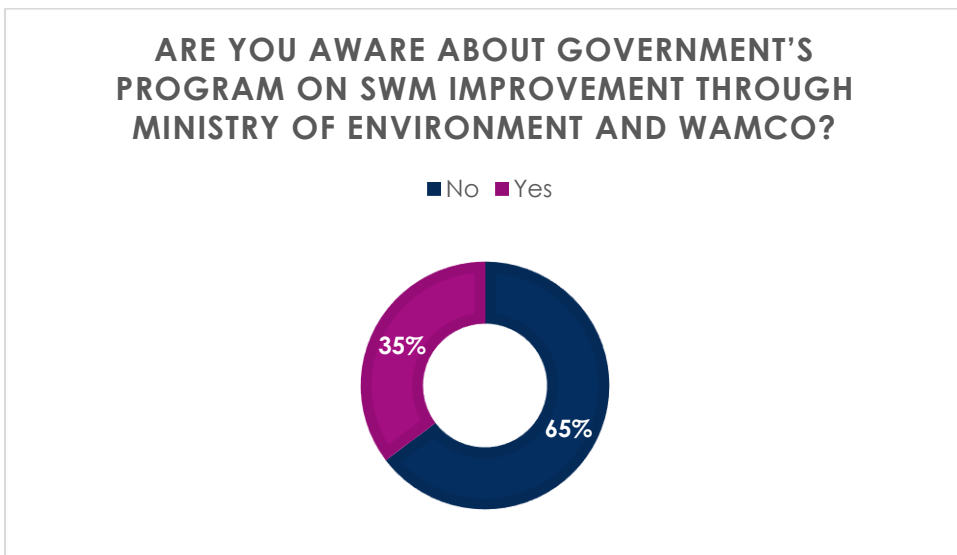
**If yes to B16, due to what?**



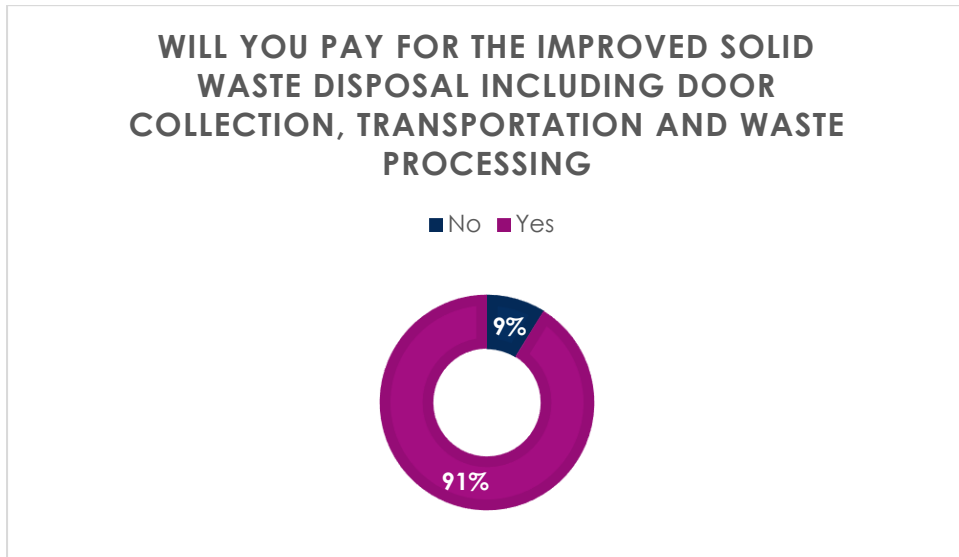
**B18. Do you think community level trainings in solid waste management will be beneficial?**



**B19. Are you aware about Government's program on SWM improvement through Ministry of environment and WAMCO?**



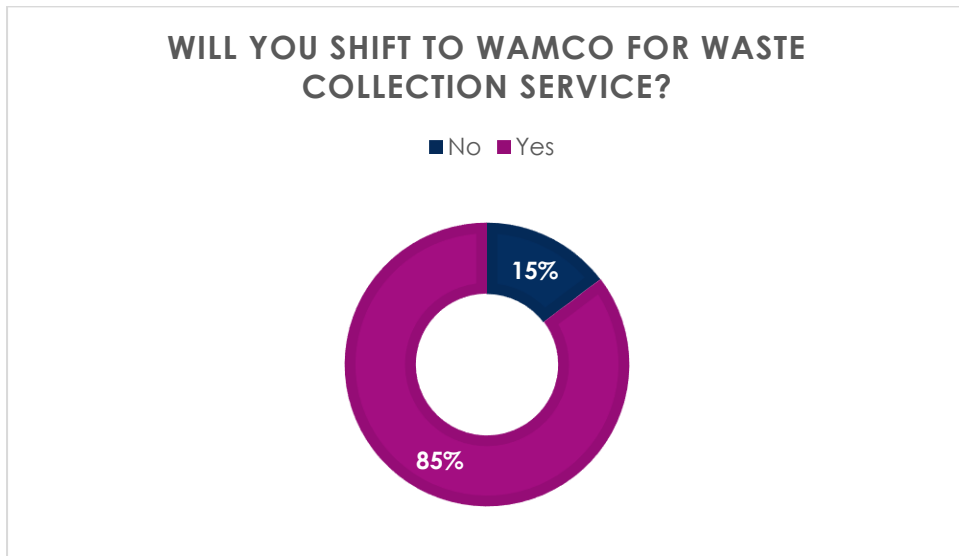
**B20. Will you pay for improved solid waste disposal including door collection, transportation and waste processing?**



**B21. If yes to B20, how much would you be willing to pay for improved waste collection and waste management services?**

Amount in MVR	Sum of Count
<0 or (blank)	19
0-499	3
500-999	3
1000-1499	4
1500-1999	1
2000-2499	2
5000-5499	2
39500-40000	1
<b>Grand Total</b>	<b>35</b>

**B22 and B23. Will you shift to WAMCO for waste collection service?**



**B24. What are the socio-economic problems face by your employees? Any other suggestions/ comments?**

	Island Name	Company Name	What are the socio-economic problems faced by your employees? Any other suggestions or comments?
1	Thilafushi	Villa Hakatha	No comments
2	Thilafushi	Villa Hakatha F n B	Conduct surveys annually to assess
3	Thilafushi	Batch construction PVT LTD	Health issues
4	Thilafushi	Wheel pvt ltd	No comments
5	Thilafushi	Mtcc	No comments
6	Thilafushi	IZ	No water and electricity
7	Thilafushi	Eve garment	No comments
8	Thilafushi	Leo trading	No comments
9	Thilafushi	Sony hardware	Yes. Food services are not so good, no regulations on road safety, parking
10	Thilafushi	Lafarge Maldives	No comments
11	Thilafushi	MALDIVE GAS	No comments
12	Thilafushi	WAMCO	No comments
13	Thilafushi	Mpl thilafushi	Heard about possible other issues. But no choice. Need to work here
14	Thilafushi	Dhamas	Infrastructure, roads, no lights at night. No security fo vehicles, parking space, abandoned vehicles, rule of law and order.
15	Thilafushi	Nalahiya trahiya trading pvt ltd	Health services only recently established, road conditions
16	Thilafushi	Maldives Structural Product MSP	Ferry schedule regularly; taxi services; garbage per tonne of the lorry
17	Thilafushi	Raajje logistics pvt ltd	Waste disposal while transferring loads
18	Thilafushi	Leo Trade	Smoke I inhalation is their main problem, no proper sewage, poor road conditions during rainy season
19	Thilafushi	Sunfront	Waste disposal into the sea can be quite problematic as difficult for boats to come near the jetty for loading n unloading goods
20	Thilafushi	Static company (aqua reef)	Mainly smoke inhalation is their main concern
21	Thilafushi	The Hawks	Fighting;Illegal ppl; drinking; Banking problem; emergency ferry/boat system;;emergency med
22	Thilafushi	Metco	No comments
23	Thilafushi	Thilafalhu cafe	No comments
24	Thilafushi	Heavy Force	Smoke, roads, emergency transport
25	Thilafushi	Antrac (maldives petroleum	No electricity no water or sewage system at the present moment, the road conditions are bad, staff live in newly reclaimed land area and no electricity from main grid is not available, company provides generators and water is carried to site for staff to use. Smoke from burning waste is the main issue.
26	Thilafushi	Gulf craft	Waste gets washed from the ocean into our facility. Seasonal problems are there, during one season flies would be a hazard. During some days smoke is so thick the person standing next to you is not visible.
27	Thilafushi	Maldives police services	Nil
28	Thilafushi	Best dives ptv ltd	Nil
29	Thilafushi	Build Maldives Company	No infrastructure, road lights, road building not provided
30	Gulheefalhu	Stelco	Ferry timing a d the transportation is quite difficult
31	Gulheefalhu	GMIZ	Wamco to pick garbage twice monthly
32	Gulheefalhu	Litus	No comments
33	Thilafushi	Apollo	Waste management is a hazard! The governeemnt should solve it as soon as possible
34	Thilafushi	GMIZ	Waste management is a hazard; WAMCO should not charge government for waste management as they have been allocated a plot of land; maybe a nominal fee; drug and prostitution was a problem but not that we have Police and they are patrolling 24/7 problems are minimised; should be given risk allowance for people working here



Republic of Maldives

Ministry of Environment and Energy

Consultancy Services for Feasibility Study for an Integrated Solid Waste Management System for Zone III (including Greater Male') and Preparation of Engineering Design of the Regional Waste Management Facility at Thilafushi



Saafu Raaje Zone III Integrated Waste Management System

Environmental and Social Impact Assessment for the Regional Solid Waste Management Facility (RSWMF) Thilafushi

Chapter on Air quality (2<sup>nd</sup> revision of 18.09.2019)

Date:	18/09/2019
Prepared by:	Ahmed Jameel
Checked by:	Chakir Kasdarli

## Revision History

---

Revision	Details	Date	Initial
01	Completion of section 7.4 and 9	12/09/2019	AJ
02	Revised version after ADB comments of 16.09.2019	18/09/2019	AJ



**KOCKS**  
INGENIEURE

**Disclaimer:**

This report has been prepared by Water solutions and Kocks Consult GmbH with all reasonable skill, care and diligence within the terms of the Contract with the client. Water solutions and Kocks Consult GmbH disclaims any responsibility to the client and others in respect of any matters outside the scope of the above.

This report is confidential to the client and the Consultant accepts no responsibility of whatsoever nature to third parties whom this report, or any part thereof, is made known. Any such party relies upon the report at their own risk.

## TABLE OF CONTENT

1	Introduction .....	1
2	Scope of work .....	2
2.1	ToR for air modelling consultant	2
3	Policy and Guidance .....	3
3.1	National legislation	3
3.2	European legislation	6
3.3	German legislation (as basis for the ADM)	7
3.4	Guidance note	8
4	Methodology .....	11
4.1	Ambiant air quality/Existing conditions	12
4.2	Air dispersion modelling (ADM)	17
4.2.1	Rationale.....	17
4.2.2	Comparaison AUSTAL2000 vs AERMOD .....	17
4.2.3	Comparaison AUSTAL2000 vs CALPUFF.....	18
4.2.4	Conclusion .....	18
4.2.5	Grid.....	19
4.2.6	Potential sensitive locations/Assessment points.....	19
4.2.7	Level of uncertainty .....	19
4.2.8	Meteorology .....	19
4.2.9	Topography.....	26
4.2.10	Building effects.....	27
4.2.11	Emissions.....	28
5	Assessment criteria .....	29
5.1	Criteria to protect human health	29
5.2	Criteria to protect ecological sites	30
6	Determination of significance of effects .....	31
7	Baseline conditions .....	31
7.1	Project location (Macrolocation)	31
7.2	Project location (Microlocation)	36
7.3	Component of the WtE facility	38
7.3.1	Stack height .....	40
7.3.2	Cooling system.....	41
7.3.3	Bottom ash treatment.....	41
7.3.4	Residual waste landfill.....	41
7.3.5	Electricity generation.....	42
7.3.6	Layout arrangement .....	43
7.4	Ambiant Air quality/Baseline survey	43

7.4.1	Air Quality baseline survey AQ 1 (Thilafushi workers camp).....	45
7.4.2	Air Quality baseline survey AQ 2 (Thilafushi 2, new reclaimed area)	46
7.4.3	Air Quality baseline survey AQ 3 (Thilafushi 3, Opposite of dumpsite).....	47
7.4.4	Air Quality baseline survey AQ 4 (Vilingili).....	50
7.4.5	Interpretations of the results .....	50
8	Identification and assessment on potential effects.....	51
8.1	General emission	51
8.1.1	Emission mass flow .....	51
8.1.2	Control of the necessity of the dispersion calculation .....	52
8.2	Air dispersion modelling for relevant parameter	54
8.3	Maximum ground level/Additional load	59
8.4	Interpretation of the results with respect to baseline conditions	70
9	Conclusions .....	72
	References .....	74

## List of Figures

Figure 1: Air Quality monitoring station with two Aeroqual Series 500 monitors.....	13
Figure 2: Location of Ambient air quality monitoring station (Source Google earth) .....	16
Figure 3: Long term average rainfall for the central atolls (Source: Maldives Meteorological Service, 2016) .....	20
Figure 4: Spatial distribution of wind speed and directions from 1986-2016 (Source: LHI, 2018) .....	23
Figure 5: Directional Distribution of Wind Statistics (% Occurrence for Wind Speed vs. Wind Direction) .....	24
Figure 6: average Wind rose over project location .....	25
Figure 7: areal picture of reclaimed area for WtE Facility .....	27
Figure 8: tentative Location of the WtE, the stack (square) and the genset (circle).....	28
Figure 9: Project location (macro-location) [Source Google Earth].....	32
Figure 10: Project location (Meso-location, distances from tentative stack location of the WtE) [Source google Earth].....	33
Figure 11: land use plan [developed by given land use plan and Google Earth Image] .....	35
Figure 12: Project location (micro-location) .....	37
Figure 13: schematic layout of the WtE Facility .....	39
Figure 14: View around AQ4 (Villingil) on 3rd March 2019.....	43
Figure 15: Air quality monitoring at location AQ1 on 19rd March 2019 .....	44
Figure 16: Air quality monitoring at location AQ3 on 20th August 2019 .....	44
Figure 17: View around AQ2 (Thilhafushi) on 25th August 2019.....	45
Figure 18: graphical presentation of survey results for SO <sub>2</sub> at AQ3 .....	49
Figure 19: graphical presentation of survey results for PM <sub>2,5</sub> and PM <sub>10</sub> at AQ3 .....	49
Figure 19: Location of the emission points where maximum load was calculated and examined .....	57
Figure 20: additional load Mercury-Deposit from the dispersion model.....	61
Figure 21: PM-Deposit from the dispersion model. ....	62
Figure 22: F-Deposit from the dispersion model.....	63
Figure 23: SO <sub>2</sub> -Deposit from the dispersion model. ....	64
Figure 24: NOx-Deposit from the dispersion model.....	65
Figure 25: Pb-Deposit from the dispersion model. ....	66
Figure 26: Ni-Deposit from the dispersion model. ....	67
Figure 27: Tl-Deposit from the dispersion model.....	68
Figure 28: Cd-Deposit from the dispersion model. ....	69
Figure 29: As-Deposit from the dispersion model.....	70

---

## List of Tables

---

Table 1: Locations for ambient air quality monitoring .....	13
Table 2: Immission rate/ambient air concentration values and irrelevant values according Nr. 4.2 of the TA Luft.....	30
Table 3: Immission rate/ambient air concentration values and irrelevant values according Nr. 4.3 - 4.5 of the TA Luft.....	30
Table 4: Summary of Thilafushi project location (macro-location .....	36
Table 5: Summary of project location (Micro-location WtE plant) .....	38
Table 6: Design parameters for Bottom ash treatment plant .....	41
Table 7: Maximum mass concentration .....	51
Table 8: Emission mass flow (for $R = 115\,713\text{ m}^3/\text{h}$ , $T = 180\text{ }^\circ\text{C}$ , $\varnothing = 2.12\text{ m}$ ) .....	51
Table 9: Minor mass flow according 4.6.1.1 TA Luft and WtE mass flow .....	52
Table 10: Minor mass flow according to Section 4.6.1.1 TA Luft - system mass flow .....	54
Table 11: Emissions Stack WtE.....	56
Table 9: Ambient air quality points .....	59
Table 10: Ambient air quality additional charge (IZ) (including statistical uncertainty).....	59



---

List of units, abbreviations and acronyms

---

Abbreviations and acronyms	
ADB	Asian Development Bank
ADM	Air dispersion modelling
AQMA	Air Quality Management Area
AQO	Air Quality Objective
As	arsenic
Cd	cadmium;
CO	carbon monoxide
Cr	chromium
CrVI	chromium VI
Cu	copper
DBO	Design-Build-Operate
GOM	Government of Maldives
GM	Greater Male'
EAL	Environmental Assessment Level
ELV	Emissions Limit Value
EU	European Union
HCl	hydrogen chloride
HF	hydrogen fluoride
Hg	mercury
HSE	Health, Safety, Environment
IED	Industrial Emissions Directive
IFC	International Finance Corporation
IWM	Integrated waste management
MOE	Ministry of Environment
MSL	Mean Sea Level
MSW	Municipal Solid waste
NH <sub>3</sub>	ammonia
Ni	nickel
NO <sub>2</sub>	nitrogen dioxide



NO <sub>x</sub>	nitrogen oxides
Pb	lead
PM <sub>10</sub>	fine airborne particulate matter with an aerodynamic diameter of less than 10 micrometers
PM <sub>2.5</sub>	fine airborne particulate matter with an aerodynamic diameter of less than 2.5 micrometers
RSWMF	Regional Solid Waste Management Facility
Sb	antimony
SBD	Standard Bidding documents
SO <sub>2</sub>	sulphur dioxide
SWM	Solid Waste Management
TA Luft	First General Administrative Regulation Pertaining the Federal Immission Control Act (Technical Instructions on Air Quality Control in the following document as " <i>TA Luft</i> ")
TOC	Total Organic Carbon
TPD	Tonnes Per Day
V	vanadium
VDI	Verein Deutscher Ingenieure (German Engineer Association)
VOCs	Volatile Organic Compounds;
WHO	World Health Organisation
WTE	Waste to Energy
<b>Units</b>	
µm	micrometre: 1 µm = 0.001 mm
mm	millimetre: 1 mm = 0.001 m
m	metre: 1 m = 0.001 km
km	kilometre
m <sup>2</sup>	square metre
ha	hectare: 1 ha = 10,000 m <sup>2</sup>
l	litre: 1 l = 0.001 m <sup>3</sup>
m <sup>3</sup>	cubic metre
ng	nanogram: 1 ng = 0.001 µg
µg	microgram: 1 µg = 0.001 mg
mg	milligram: 1 mg = 0.001 g

g	gram: 1 g = 0.001 kg
kg	kilogram: 1 kg = 0.001 Mg (t)
Mg	megagram (same as t: tonne)
s	second
h	hour
d	day (calendar day)
a	year
°C	degrees Celsius
K	Kelvin
Pa	pascal: 1 Pa = 0.01 mbar (millibar)
kPa	kilopascal: 1 kPa = 1,000 Pa
MPa	megapascal: 1 MPa = 1,000,000 Pa
kJ	kilojoule
kWh	kilowatt hour: 1 kWh = 3,600 kJ
MW	megawatt
OU	odour unit
OU/m <sup>3</sup>	odorous substances concentration
LU	livestock unit (1 livestock unit equals an animal live weight of 500 kg)

## Glossary

<p>Immissions</p>	<p>Immissions shall be air pollutants affecting humans, animals, plants, soil, water, the atmosphere, cultural assets and any other property.</p> <p>Immissions shall be indicated as follows:</p> <ul style="list-style-type: none"> <li>a) Mass concentration, as mass of air pollutant per unit volume of polluted air; for gaseous substances, mass concentrations are to be referenced to 293.15 K and 101.3 kPa.</li> <li>b) Deposition, as mass of pollutant per unit area of ground per unit time.</li> </ul> <p>Synonym of immission : Ambient air quality</p>
<p>Immission Indicators,</p>	<p>Immission indicators describe the initial load, the additional load or the total load of the respective air pollutant. The initial load shall describe the pre-existing load of a pollutant. The additional load shall characterise the concentrations, which can be expected to be caused (for planned installations) or which are actually caused (for existing installations) by the planned project. With respect to planned installations, the indicator for the total load shall be calculated on the basis of the initial load plus the additional load indicators. With respect to existing installations, this indicator equals the initial load.</p>
<p>Assessment Points,</p>	<p>Assessment points shall be those points in the vicinity of an installation for which immission indicators, indicative of the total load, are determined.</p>
<p>Grid Points</p>	<p>Grid points shall be those points in the vicinity of an installation for which the additional load is calculated (immission projection).</p>
<p>Immission Values also known as immission rate or ambient air values</p>	<p>The annual immission value shall be the concentration or deposition value of a substance averaged over one year.</p> <p>The daily immission value shall be the concentration value of a substance averaged over one calendar day, taking into account the respective frequency limit for excess values (number of days) over one year.</p> <p>The hourly immission value shall be the concentration value of a substance, averaged over a whole hour (e.g., from 8 a.m. to 9 a.m.), taking into account the respective frequency limit for excess values (number of hours) over one year.</p>
<p>Waste Gas Volume and Waste Gas Volumetric Flow Rate</p>	<p>Waste gases shall be carrier gases with solid, liquid or gaseous emissions. any data regarding the waste gas volume and the waste gas volumetric flow rate are referenced to standard conditions (273.15 K and 101.3 kPa) after subtraction of the water vapour content unless explicitly indicated otherwise</p>
<p>Emissions</p>	<p>Emissions shall be air pollutants originating from an installation.</p> <p>Emissions shall be indicated as follows:</p> <ul style="list-style-type: none"> <li>a) mass of substances or groups of substances emitted as related to the volume (mass concentration) <ul style="list-style-type: none"> <li>aa) of waste gas under standard conditions (273.15 K and 101.3 kPa) after subtraction of the water vapour content,</li> <li>bb) of waste gas (wet) under standard conditions (273.15 K and 101.3 kPa) before subtraction of the water vapour content,</li> </ul> </li> <li>b) mass of substances or groups of substances emitted per unit time as a mass flow (emitted mass flow); the mass flow is the total emission occurring in one hour of normal operation of an installation under operating conditions which are most unfavourable to the maintenance of air quality;</li> </ul>

	<ul style="list-style-type: none"> <li>c) quantity of fibres emitted (fibre dust concentration), as related to the volume of waste gas under standard conditions (273.15 K and 101.3 kPa) after subtraction of the water vapour content;</li> <li>d) ratio of the mass of emitted substances or groups of substances to the mass of products generated or processed or to stocking density (emission factor); the mass ratio shall take into account the total emissions from the installation occurring over one day of normal operation of such installation under operating conditions most unfavourable to the maintenance of air quality;</li> <li>e) amount of Odour Units of odorous substances emitted, as related to the volume (odorous substances concentration) of waste gas at 293.15 K and 101.3 kPa before subtraction of the water vapour content; the odorous substances concentration is the olfactometrically-measured ratio of volume flows when diluting a waste gas sample with neutral air down to the odour threshold, indicated as a multiple to the odour threshold.</li> </ul>
Emission Ratio	The emission ratio shall be the ratio of the mass of an air pollutant emitted in waste gas to the mass of supplied fuels or input materials; it shall be provided as a percentage.
Emission Reduction Ratio	The emission reduction ratio shall be the ratio of the mass of an air pollutant emitted in waste gas to its mass supplied in crude gas; it shall be provided as a percentage. The odour reduction ratio is an emission reduction ratio.
Emission Standards and Emission Limits	<p>Emission standards shall provide the basis for emission limits. The emission limits shall be established in the letter of permit or in a subsequent order as</p> <ul style="list-style-type: none"> <li>a) permissible fibre dust, odorous substances or mass concentrations of air pollutants in waste gas provided that <ul style="list-style-type: none"> <li>aa) any daily mean values do not exceed the established concentration level and</li> <li>bb) any half-hourly mean values do not exceed twice the established concentration level,</li> </ul> </li> <li>b) permissible mass flows, as related to one hour of operation,</li> <li>c) permissible mass ratios, as related to one day (daily mean values),</li> <li>d) permissible emission ratios, as related to one day (daily mean values),</li> <li>e) permissible emission reduction ratios, as related to one day (daily mean values), or</li> <li>f) any other requirements to provide precaution against harmful effects of air pollutants on the environment.</li> </ul>

## Consultation/Comments & answers matrix

Following the ADB mission held in Male' between the 04-08.08.2019 the following questions and comments have been addressed to the consultant:

N°	ADB experts Comments	Answer/Reference after 1st draft comments	Comments of ADB expert team (Ricardo) from 16.09.2019	Consultant's answers
AQ1	Need for robust baseline data to inform air quality modelling and to confirm airshed status	(new comments)	Update: Further air quality monitoring is reported as being currently in progress ('Air quality and air dispersion modelling report 190828' page 41), which is welcomed. The measurements made during this period should be analysed and assessed against the relevant limit values to determine background conditions and whether the location should be treated as a degraded airshed.	Please see updated Chapter 7.4. It could not be clearly determined whether the location should be treated as a degraded airshed or not. The site is clearly influenced by the adjacent dumpsite and its open burning. (see Chapter 7.4)
AQ2	Impact of the proposed facility on air quality	(new comments)	Update: AQ2 comments remain valid. The new report 'Air quality and air dispersion modelling report 190828' is unfinished, but does not refer to the EHS requirement for the contribution from a facility to account for less than 25% of the air quality standard/guideline. When baseline air quality data are available, the assessment results should be reinterpreted in the light of these requirements.	Please see Chapter 8.4. It is obvious that new facilities emissions are far below the EHS requirements. The main problematic is the ambient baseline condition which is mainly influenced by the dumpsite and which contributes to a temporary degraded airshed.
AQ3	Required assessment of average emission limit values for heavy metals	(new comments)	Update: these substances are now all listed in Table 6 (p44). These substances have been considered in the assessment, at least at the preliminary screening stage. The assessment states (p51) that "In the calculation, the heavy metal nickel was considered representative of the group of heavy metals and their components: antimony, chromium, copper, manganese, vanadium, tin, lead, cobalt, nickel". The reason for limiting the assessment to nickel is not explained. The assessment for all substances listed above should be clearly set out.  The new report also states that: 'For ammonia and hydrogen chloride (5.2.4 Class III TA Luft), for carbon	For the calculation at the assessment point the emission value for Nickel was considered as 0,5 mg/m <sup>3</sup> which is the emission threshold value for all heavy metals (Antimony, chromium, copper, mangan, vanadium, tin, lead, cobalt and nickel) which means we are considering a worst case.

N°	ADB experts Comments	Answer/Reference after 1st draft comments	Comments of ADB expert team (Ricardo) from 16.09.2019	Consultant's answers
			<p>monoxide, for organic substances (expressed as total C) as well as dioxins and furans no minor mass flow are set in the regulations therefore there is no need to undertake a detailed dispersion modelling for these parameters either.' These substances should in principle be included in the assessment. It is likely that no significant impacts would be identified for ammonia or hydrogen chloride. However, emissions of dioxins and furans should be modelled and, as a screening approach, evaluated against the WHO guideline of Air concentrations of 0.3 pgTEQ/m<sup>3</sup> which is used to identify local emission sources that need to be identified and controlled</p>	
AQ4	Confirmation of stack height	(new comments)	<p>The revised assessment confirms the proposed stack height of 50 metres, which would be adjacent to a building of height 43 metres. This appears to be relatively low for a facility of this nature. AQ4 remains valid.</p>	<p>This comment is wrong. The building height is 30 m (and not 43 m). There is no reference in the report that the building is 43 m high. The statement relatively low is not clear enough. If ADB experts has another formula how to calculate the stack height than please do it and provide us with a clear height</p>
AQ5	Reliability of model results	(new comments)	<p>The new report 'Air quality and air dispersion modelling report 190828' states: 'The results have been checked again and are considered as right and robust. The model used is a state of the art, accepted model by the German Ministry of Environment. It reaches it best performances in flat environment and poor database which is the case in the Maldives. The comparison with plants in the UK which has provenly different ambient and environmental conditions could not be considered as appropriate.' The consultant is correct: the situation in the Maldives is different to the UK, and different dispersion characteristics would be expected. However, our experience is based on the use of ADMS</p>	<p>The Consultant is unable to run another model as the one presented in this report. As far as there is no mandatory requirement to use AERMOD or ADMS in the national ToR as well in the EHS guidelines, the consultant estimate to use an internationally recognized ADM. Rationale for using this model has been presented.</p>

N°	ADB experts Comments	Answer/Reference after 1st draft comments	Comments of ADB expert team (Ricardo) from 16.09.2019	Consultant's answers
			<p>and AERMOD for modelling assessments worldwide, not just in the UK. This comment remains valid.</p> <p>In the context of assessing mercury, the report states “[As] pre-pollution with air pollutants at the site is not known (baseline), so it is assumed that the calculated values represent the total load.” This seems to imply that the assessment has been carried out by assuming that there is no baseline contribution due to mercury. This is not a conservative approach to the assessment, and the assessment should take account of baseline levels of air pollutants.</p>	<p>This text has been changed. The additional represents the “process contribution” from the WtE. Considering this source as a single standing source, the results from the calculations shows that increase of pollutants in the atmosphere is far below the requirements of IFC. The combination of process contribution and baseline unfortunately not (for the parameter PM, SO<sub>2</sub>, NO<sub>2</sub>). This is mainly related to the influence of the dumpsite.</p>
AQ6	Calculation of emission mass flows for nitrogen oxides (nitrogen monoxide and nitrogen dioxide), specified as nitrogen dioxide	(new comments)	Further clarification has been provided which indicates that there may be a further factor of 90% involved in calculating nitrogen dioxide concentrations. This is not clearly explained, and does not account for the discrepancy, but the difference is small and not likely to significantly affect the study conclusions.	OK
AQ7	Responses provided to questions from ADB Experts			
1	Air quality assessment to be undertaken following international good practice, for which ADB would usually refer to IFC EHS Guidelines. Since German approach has been utilized and ADB is not familiar with this, it needs to be demonstrated how this is consistent with international good practice, notably in stack height calculation, scoping out potential air quality impacts, and in terms of the dispersion model used, the EIA should also include the justification for using the German approach	See Chapter 4 “Methodology”	The report explains the background to the German method, but does not relate this to the IFC EHS methodology which is specified for use in the ADB Safeguard Policy Statement (2009). See AQ1 and AQ2 above.	<p>It is not very clear for the consultant, what the ADB experts wants more. Concerning AQ1 and AQ2 we completed the report accordingly. The German approach does not differs from other approaches which is :</p> <ul style="list-style-type: none"> <li>• Considering Regulatory requirements (in this case due to non availability of Maldivian regulation, we used German regulations and International standards</li> </ul>

N°	ADB experts Comments	Answer/Reference after 1st draft comments	Comments of ADB expert team (Ricardo) from 16.09.2019	Consultant's answers
				<ul style="list-style-type: none"> <li>• Significance of the source (detailed description of WtE facility was provided in the document</li> <li>• Location of the emitting facility relative to other sources (Macro, Meso and Microlocation presented)</li> <li>• Location of sensitive receptors (done)</li> <li>• Existing ambient air quality, and potential for degradation of the airshed from a proposed project (The airshed is already temporary degraded due to the dumpsite and is tending to be better after the dumpsite closure)</li> <li>• Technical feasibility and cost effectiveness of the available options for prevention, control, and release of emissions (part of the complete EIA)</li> </ul>
2	in any case, as ADB is used to seeing assessments undertaken against terminology of IFC EHS Guidelines, the results of German approach should be presented in that context in EIA and avoid using German specific terminologies.	Whether it was possibly terminology has been harmonized additional glossary was presented on page 1-2	The glossary is useful, but terminology has not been harmonized. E.g. sections 8.1.2 and 8.2.1.2 use the German terminology throughout.	Terminology has been harmonized. Whether it was not possible to use another terminology the glossary can be used.
3	Specifically German approach ambient air quality standards are based on WHO interim targets, rather than the WHO	For baseline assessment table 1.1.1 of IFC HSE guidelines (WHO guidelines was used) for emission values German	The WHO guidelines or EU standards should be used throughout the assessment (not just for baseline assessment) rather than using the approach based on	The German standards are mainly similar to EU standards, for certain parameters even more stringent.



N°	ADB experts Comments	Answer/Reference after 1st draft comments	Comments of ADB expert team (Ricardo) from 16.09.2019	Consultant's answers
	guidelines; the EIA is to also discuss results in context of latter.	standards have been used which are more stringent than EU IED standards presented in the IFC EHS sector guidelines for MSW treatment facilities (see Chapter 4 "methodology")	German standards. See also AQ2 Reference to emission standards is not relevant	
4	The status of the airshed does need to be reported, for this baseline ambient air quality monitoring at Thilafushi is required	Thilafushi Island airshed is actually highly influenced by the uncontrolled burning of the illegal dumpsite. Once the dumpsite fires have been stopped (latest with the operation of the WtE), there is no further emission source like the dumpsite. The fires and smokes are temporary and with actual baseline air monitoring no significant pollution has been detected. If there was a similar source (after extinguishing the fires on Thilafushi) the concerns about the degraded airshed would be reasonable. Actually on Thilafushi the dispersion of any potential pollutant that yet may be produced is unrestricted.	Report is incomplete. The issue of open burning can be addressed when considering the results of baseline air quality monitoring. The report could explain why baseline levels are considered likely to be negligible: this would need to take account of existing industrial and other activity in the local area.	Based on the updated baseline chapter and its results we did an assessment of the airshed. Baseline monitoring have been done on 4 locations at 3 different periods: <ul style="list-style-type: none"> <li>• June 2018</li> <li>• March 2019</li> <li>• August 2019</li> </ul> Covering main parameters as per ToR with a monitoring and recording frequency which able to develop baseline parameters comparable to WHO guidelines for ambient air quality. See chapter 7.4

N°	ADB experts Comments	Answer/Reference after 1st draft comments	Comments of ADB expert team (Ricardo) from 16.09.2019	Consultant's answers
5	Monitoring should include NO <sub>2</sub> , SO <sub>2</sub> , PM <sub>10</sub> and PM <sub>2.5</sub> as well as all parameters listed in national TOR including CH <sub>4</sub> , CO, Cd, Pb, Hg, HC which do not yet appear to have been monitored (or it needs to be explained why the cannot be, but if mercury has more than negligible impact it should have baseline).			NO <sub>2</sub> , SO <sub>2</sub> ; PM <sub>10</sub> ; PM <sub>2.5</sub> done at all survey points. CH <sub>4</sub> , CO done at selected survey points. Pb, Cd, Hg and HC could not be done due to the non-availability of adequate equipment. Additional paramaters done : CO <sub>2</sub> , H <sub>2</sub> S See Chapter 7.4
6	Monitoring should enable the ambient air quality to be clearly established by reference to WHO guidelines: 1 hour averages for NO <sub>2</sub> , 10 minute and 24 averages for SO <sub>2</sub> , and 24 hour averages for PM <sub>10</sub> and PM <sub>2.5</sub> . Monitoring program should be done over a period of two weeks, i.e. not just a one off and undertaken in different seasons (second season can be added to EIA at later date) to reflect changes in wind direction etc.	Done see page 42.	Report incomplete	Done see Chapter 4 methodology and Chapter 7.4 Baseline
7	The ambient air quality data already collected needs to be adequately presented with averaging period, units etc.They also need to be compared to the WHO guidelines to determine if the airshed is degraded.	Done see page p 42	Report incomplete	Done see Chapter 7.4 Baseline
9	The assessment to include consideration of all the parameters in the EU IED even if it is just to scope out they have a negligible impact	Done	All pollutants now included. Assessment of metals needs to be further explained; assessment of dioxins & furans is required. See AQ3.	

N°	ADB experts Comments	Answer/Reference after 1st draft comments	Comments of ADB expert team (Ricardo) from 16.09.2019	Consultant's answers
10	<p>Under German approach, mercury is reported to have more than a negligible impact. It needs to be clarified why in terms of input data used, ideally to support that WtE is clean technology preferable if mercury levels were negligible. It may raise concerns why mercury is flagged, as perhaps it relates to burning of unsegregated hazardous waste?</p>	<p>The 17<sup>th</sup> ordinance for the implementation of the Federal Immission control Act (Ordinance on Incineration Plants for municipal waste and similar combustible substances) has defined an maximum emission value of 0,03 mg/m<sup>3</sup>. This value is monitored and controlled at the stack To respect this value active carbon is used in the flue gas cleaning in order to deposit the mercury. The problematic with mercury is that it is difficult to identify the source in the waste. Therefore it is a venture that the mercury is provided by hazardous waste. With the maximum flue gas volume flow and maximum allowed mercury concentration we have a mass flow which is over the threshold value. Therefore an air dispersion model is needed (made with Astral200). This was made an the expert (sub-contractor) came to the conclusion that there is</p>	<p>Provided issues with the air quality assessment can be addressed (AQ1, AQ2, AQ4, AQ5), the evaluation of mercury is acceptable.</p>	<p>OK</p>

N°	ADB experts Comments	Answer/Reference after 1st draft comments	Comments of ADB expert team (Ricardo) from 16.09.2019	Consultant's answers
		no critical additional pollution		
11	Consultant has modelled the parameters in Table 10, whilst not required under German legislation it is important to ADB the EIA clearly demonstrates the air quality impacts of the WtE plant on a spatial basis and, given what is currently degraded airshed, that maximum project contribution impact is not significant. Thus dispersion plots for all the modelled parameters should be provided,	Done	The assessment does not clearly demonstrate the air quality impacts of all pollutants: see comments AQ1 to AQ6 above.  Dispersion plots were provided for some parameters: these are a mix of airborne concentration and deposition plots.	Please precise what ADB experts understand under "clearly". The assessment is saying that parameters below minor mass flow have a negligible impact, for those over the minor mass flow an ADM has to be conducted to see "the dispersion effect" of this parameter and consequently its impact. Dispersion plots have been provided upon request of the ADB expert after on site mission. Most of the plots show clearly that the impacts are low at the receiving sensitive points
12	Also confirm the maximum ground level concentration (additional load in German terms) that the model has predicted. Note the maximum ground level concentration may not be at the same location as ANP1 receptor point included in the model by consultant. The dispersion modelling is required by the national TOR.	Ambiant air quality baseline measures have not been done actually for Mercury.  ADB is right that maximum ground level concentration may not be at the same location as ANP 1. On the ANP1 we have factories with people working 8-10 h permanetly exposed to hazards.  On our experts opinion it makes less sense to undertake an extensive Mercury baseline survey:  Actually Mercury is released in a diffuse form	This comment refers to model outputs, not to ambient air quality measurements. The consultant's response does not address the question.	We confirm these figures as it was mentioned in the report received from our sub-consultant. If ADB experts identified a mistake then please advice then we could check with the data set. But a first cross check does not show any discrepancies

N°	ADB experts Comments	Answer/Reference after 1st draft comments	Comments of ADB expert team (Ricardo) from 16.09.2019	Consultant's answers
		<p>from the old dumpsite on fire. This releasing will be stopped as soon as the dumpsite is closed and rehabilitated.</p> <p>Mercury baseline surveys are complex and costly because of the surveying of vaporous gaz and of particle-bound mercury. In order to meet the requirements of ADB it is necessary to have a narrow mesh of measurement points. Also the analytics is very expensive.</p>		
13	<p>Confirm the basis for 8,000 hours operation, as 8,200 hours availability is also mentioned. Is it possible it could operate for more hours? Though WtE plant will not operate all the time, dispersion modelling is usually done for 8,760 hours since it is not known exactly which days of the year (under what met conditions) will be operational or not.</p>	<p>We confirm that ADM was made on the communicated operation hours of 8,000 hrs. There are mandatory yearly revisions imposed to the contractor so it is not expected that it could be operated longer</p>	<p>The response addresses the question, and confirms that the assessment is not conservative in respect of operating hours. This should be taken into account when interpreting the results.</p>	<p>The WtE facility needs mandatory yearly revision and maintenance time where the facility is shut down or working partially. These are mandatory requirements to the DBO contractor. So it is almost impossible that the WtE facility will operate at all thime and therefore a realistic operation time of 8,000 is considered as realistic for the conclusion of the outcome of this report</p>
14	<p>The consultant needs to check the results of the model, as per our technical advisor the emissions of NO<sub>2</sub>, SO<sub>2</sub> and PM<sub>10</sub> appear to be relatively low for a WtE plant of this scale. At the minute the impacts are not significant, but this raises a concern they have been underestimated. Need to confirm the</p>	<p>The results have been checked again and are considered as right and robust. The model used is a state of the art, accepted model by the German Ministry of Environment. It reaches</p>	<p>The consultant is correct: the situation in the Maldives is different to the UK, and different dispersion characteristics would be expected. Our experience is based on the use of ADMS and AERMOD for modelling assessments worldwide, not just in the UK. Our comment AQ5 remains valid.</p>	<p>There are more than 140 models developed and accepted only in Europe.</p> <p>As per National ToR and also as per IFC performance standard it is not mandatory to use a specific ADMS or AERMOD. As a German consultants we have used Austal 2000 which is the</p>



N°	ADB experts Comments	Answer/Reference after 1st draft comments	Comments of ADB expert team (Ricardo) from 16.09.2019	Consultant's answers
	<p>model inputs are appropriate and were correctly inputted and why model concentrations can be considered as robust. This issue may relate to either input data or the type of model used which does not follow same principles as more frequently used ADMS or AERMOD.</p>	<p>it best performances in flat environment and poor database which is the case in the Maldives. The comparison with plants in the UK which has provenly different ambient and environmental conditions could not be considered as appropriate</p>		<p>official reference model of the German Regulation on Air Quality Control, listed as an accepted model by the European Environment agency and the 11th International Conference on Harmonization within Atmospheric Dispersion Modeling for Regulatory Purposes, held in Cambridge, England.</p> <p>The model is considered as robust and has been runned two times. The model running (including additional parameters) costs 8,000 EUR. The consultant cannot afford to use a second model for consistency check anymore. If ADB experts are not convinced about the results we suggest to engage a special consultant for consistency check with AERMOD or other ADM model</p>

# AIR QUALITY REPORT WtE THILAFUSHI

## 1 Introduction

The ambient air quality status of Maldives is currently unknown due to the lack of monitoring data. It is generally considered good as the sea breezes flush the air masses over the small the islands. However rapid urbanization and economic growth in the recent years has shown noticeable changes in the air quality, particularly in the Male' region. Aside from the increased land and sea vessels, diesel power generation, and construction, open burning in Thilafushi is also a significant source of air pollution in the region.

The proposed WtE Facility will treat approximately 500 TPD of municipal waste (Household waste and similar to Household waste) based on the estimated throughput at design point, generating as a "by-product", electricity. This air quality report for the proposed facility was carried out as follows:

- a) Outline review of the policy context for air quality.
- b) Assessment of baseline air quality
- c) Identification of potentially sensitive locations
- d) Calculation of the minimum stack height
- e) Identification of potential parameters which needs a more detailed dispersion modelling
- f) Evaluation of forecast levels of released substances against relevant standards, guidelines, critical levels and critical loads
- g) Dispersion modelling study of emissions to forecast air concentrations and deposition rates at potentially sensitive locations
- h) Conclusions

The main focus of the air quality assessment was the evaluation of modelled levels against relevant standards and guidelines. Levels of relevant substances were forecast at sensitive receptors to enable an assessment of the effects on air quality with regard to human health risks and environment to be evaluated.

As the Maldives did not have a wide range of air quality survey network, therefore baseline assessment have been done through temporary field measures.

The proposed development is forecast to have no significant effects on air quality during abnormal operating conditions or due to road traffic emissions, and no significant cumulative effects are forecast to occur. No amenity issues such as odours or dusts would be expected to arise outside the site boundary, and emissions to air from the proposed facility are forecast to have no significant effects on the local environment.

The proposed facility will have no significant adverse effects on air quality. Consequently, it was concluded that no further mitigation is necessary, other than the extensive mitigation and control measures already built into the proposed facility.



## 2 Scope of work

### 2.1 ToR for air modelling consultant

For this special purposes of establishing a detailed and reliable air quality report (as part of a complete EIA), Water solutions and Kocks Consult GmbH hired The Engineer Company Ulbricht GmbH from Germany a specialised consultant in the field of environmental consultancy, permitting procedures and noise abatement.

The scope of work was to undertake:

- the stack height calculation
- The calculation and assessment of air pollutants emission

According First General Administrative Regulation Pertaining the Federal Immission Control Act (Technical Instructions on Air Quality Control – TA Luft).

For the purpose of this work Water Solutions and Kocks Consult GmbH have submitted the following documentation to the consultant

[1] The emission values according Industrial Emissions Directive (IED) (2010/75/ EU, 2010) and 17th Ordinance for the implementation of the Federal Immission control Act (Ordinance on Incineration Plants for municipal waste and similar combustible substances (the more stringent had to be used, dioxins and furans according IED)

[2] The data set for Thilafushi from the National Maldives meteorological service

[3] The dimensioning parameter for WtE, particularly the flue gas cleaning

## 3 Policy and Guidance

### 3.1 National legislation

The proposed SWM project will be governed by the laws of the Government of Maldives and the implementing regulations promulgated in accordance with such laws. As summarized below, the legal and regulatory framework for the protection and preservation of the environment of the Maldives with respect to solid waste management is currently evolving to conform to international standards within the unique context of the Maldivian natural environment. In light of the development of a comprehensive national solid waste management program including establishment of facilities to provide state of the art solid waste disposal, recycling and resource recovery, it is expected that certain existing proposed laws, draft regulations and temporary guidelines concerning solid waste management will be significantly revised and promulgated in binding final form during the course of the project. To the extent that Maldivian laws and regulations become final they shall be binding upon the project proponents superseding analogous standards referenced herein.

At present, Maldives does not have a national air quality policy or a national ambient air quality standard. However there are legislations and programmes to prevent air pollution such as Environmental Protection and Preservation Act (4/93), Draft Waste Incineration Guideline, Concrete Batch Plant Guideline and the Vehicular Emission Standard (MEE, 2017).

#### [The Environmental Protection and Preservation Act \(eppa\) 1993](#)

The Environmental Protection and Preservation Act (EPPA) of the Maldives (Law No. 4/93) is an umbrella law that provides statutory powers regarding environmental regulation and enforcement.

The relevant components of the EPP Act 1993 are:

#### Environmental Guidance

Article (2) The concerned government authorities shall provide the necessary guidelines and advise on environmental protection in accordance with the prevailing conditions and needs of the country. All concerned parties shall take due considerations of the guidelines provided by the government authorities.

#### Environmental Protection and Conservation

Article (3) The Ministry of Environment shall be responsible for formulating policies, rules and regulations for protection and conservation of the environment in areas that do not already have a designated government authority already carrying out such functions.

#### Protected Areas and Natural Reserves

Article (4) The Environment Ministry shall be responsible for identifying and registering protected areas and natural reserves and drawing up of rules and regulations for their protection and preservation.

#### Environmental Impact Assessment

Article (5) (a) An EIA shall be submitted to the Environment Ministry before implementing any developing project that may have a potential impact on the environment.

The EIA process in the Maldives is coordinated by the Environment Protection Agency (EPA) in consultation with relevant government agencies and National Commission for the Protection of the Environment (NCPE). The first step in environmental assessment process involves screening of the project to be classified as one that requires an Initial Environmental Examination (IEE) or one that requires a full Environmental Impact Assessment (EIA). Based on this decision, the Ministry then decides the scope of the EIA which is discussed with the proponent and the EIA consultants in a “scoping meeting”. The consultants then undertake the EIA starting with baseline studies, impact prediction and finally reporting the findings with impact mitigation and monitoring plan. The EIA report is reviewed by EPA following which an EIA Decision Note is given to the proponent who will have to implement the Decision Note accordingly. As a condition of approval, appropriate environmental monitoring may be required and the proponent will have to report monitoring data at required intervals to the Ministry.

### Environmental Impact Assessment regulation, 2007

The Environment Ministry issued the EIA Regulation in May 2007, which guides the process of undertaking the Environmental Impact Assessment in the Maldives. This Regulation provides a comprehensive outline of the EIA process, including the application to undertake an EIA, details on the contents, format of the IEE/EIA report, the roles and responsibilities of the consultants and the proponents as well as minimum requirements for consultants undertaking the EIA.

The objective of the Maldivian Environmental Impact Regulations, 2007 is to serve as a decision making tool for stakeholders in assessing the potential significant environmental impacts of a development proposal at the same time providing required guidance in obtaining environmental approval for such projects in the form of Environmental Decision Statement.

The Table of Contents for Initial Environmental Examination or EIA as specified in Schedule E of the EIA Regulations requires the proponent to furnish a detailed description of the natural, economic and human environment. This includes

- description of site characteristics including soil type, relief, landforms, present land use and drainage system
- type of flora and fauna, rare or endangered species, sensitive habitats of ecological importance including wetlands and mangroves
- marine environment including rocky bottom, coral reefs and sea grass beds
- beach systems; composition; stability; current; tide and wave dynamics
- description of surrounding infrastructure including utilities
- socio-economic characteristics including demographic profile, economic activities, housing and utilities, employment statistics and available skills, labour availability, unique cultural characteristics
- other attributes of the locality e.g. amenities and recreational values

The proposed WtE and landfill project is categorized under “Schedule D” list of projects requiring an EIA study.

### Post EIA monitoring, auditing and evaluation

The EIA Regulations 2007 provides a guideline of the environmental monitoring programme that should be included in EIA reports as monitoring is a crucial aspect of the EIA process.

Accordingly, the monitoring programme shall outline the objectives of monitoring, the specific information to be collected, the data collection program and managing the monitoring programme. Managing the monitoring programme requires assigning institutional responsibility, enforcement capability, requirements for reporting and ensuring that adequate resources are provided in terms of funds, skilled staff and the like.

### Solid waste management regulation

The main objective of the regulation is to implement the National Solid Waste Management Policy and through that protect the environment by;

- minimizing the impact of waste on the environment including, in particular, the impact of waste so far as it directly affects human health;
- Establishing an integrated framework for minimizing and managing waste in a sustainable manner; and putting in place uniform measures to seek to reduce the amount of waste that is generated, and where waste is generated, to ensure that waste is reused, recycled and recovered in an environmentally sound manner before being safely treated and disposed.

The regulation also takes note in detail accounts of the following fields in its enactment.

Waste management measures - Waste Management Standards, Plans, Protocols of declaration of priority wastes, Extended producer responsibilities, Prohibition of unauthorized disposal of waste, Littering, Container standards for collection of waste in public places, Waste Collection standards in sea vessels, Waste collection facilities standards in ports, Protocols in Reduction, re-use recycling and recovery of waste, Waste Management activities list and Protocols of restrictions on provision of waste management services.

Waste Management Licenses – Basic requirements for licensing, key standards, the validity period of the license, transfer protocols of a license, protocols for surrendering a license, license fees and governance of a license register.

Transportation of Waste - Duties of personnel transporting the waste, protocols of exporting and transboundary transfer of hazardous wastes, protocols of transportation of waste from one island to another, duties of receivers of waste and accidentals protocols at sea

Monitoring, Inspection, Auditing and Enforcement - Duty to furnish information, duty to reporting, Notice from the Administering Authority requiring a review of activities carried out under a license, Revocation of a license, Defrayal of Administering Authority costs, Register of fines and administrative actions, Inspectors, Establishment of national waste information system, National Waste Management Status Reports.

Clause 18 of this regulation restricts provision of waste management services without obtaining a licence for the following activities:

- Operate a waste management facility
- Operate waste collection and transportation services
- Waste recycling services
- Operation of landfills

### Waste management policy

Former MHTE (Now MoE) has published a National Solid Waste Management Policy for the Maldives. The aim of the waste management policy is to formulate

and implement guidelines and means for solid waste management in order to maintain a healthy environment. The developer shall follow any guidelines /regulations on waste management that the government may introduce.

Waste management during construction and operation of the proposed project will be guided by the relevant laws, regulations and policies related to waste in Maldives.

Review of the Maldivian regulatory framework during the course of the baseline monitoring exercise revealed that there exists limited regulations/standards which are appropriate to the present study and can be referred for compliance to the environmental components being monitored. Hence an attempt has been made in accordance with IFC PS requirements to identify the internationally recognized standards viz. WHO which has been referred to review conformance with the baseline values of the various environmental parameters being monitored. The list of such international standards has been provided below.

#### [WHO air quality guidelines, 2005](#)

the WHO Air quality guidelines as revised in 2005 (Refer Annex 3.7) represent the most widely agreed and up- to-date assessment of health effects of air pollution, recommending standards for air pollutants viz. PM10, PM2.5, SO<sub>2</sub>, NO<sub>x</sub> and Ozone at which the public health risks are significantly reduced. Necessary efforts has therefore been made by the proponent to compare the baseline air pollutant values monitored with the WHO air quality standards to establish any possible deterioration in ambient air quality and subsequent impact on worker health due to emissions that are resulting from open burning of solid wastes. Significant improvement in ambient air quality, if any due to implementation of the proposed waste management facility will also be verified based on the WHO standards.

#### [Male' declaration on control and prevention of air pollution and its likely transboundary effects for South Asia](#)

The objectives of Male' Declaration includes:

Assessing and analyzing the origin and causes, nature, extent and effects of local and regional air pollution,

Developing and/or adopting strategies to prevent and minimize air pollution

Setting up monitoring arrangements beginning with the study of sulphur and nitrogen and volatile organic compounds emissions, concentrations and deposition.

The proposed project will minimize the air pollution caused by the existing waste management practices of open burning of mixed waste in Thilafushi.

### **3.2 European legislation**

The Industrial Emissions Directive (IED) (2010/ 75/ EU, 2010) brings together seven existing directives, including the Waste Incineration Directive, into one piece of legislation. The IED outlines total emission limit values (ELVs) for a number of pollutants typically emitted during waste incineration. These are NO<sub>x</sub>, CO, total dust, HCl, HF, SO<sub>2</sub>, organic substances, trace metals, and dioxins and furans. The design and operation of all new waste incinerations facilities must ensure compliance with the ELVs.

### 3.3 German legislation (as basis for the ADM)

*First General Administrative Regulation Pertaining the Federal Immission Control Act (Technical Instructions on Air Quality Control – TA Luft) published in the Joint Ministerial Gazette from 30 July 2002 (English translation)*

At the national level in Germany, the Act on the Prevention of Harmful Effects on the Environment Caused by Air Pollution, Noise, Vibration and Similar Phenomena (Federal Immission Control Act - BImSchG) is at the core of the body of statutory instruments that makes up immission control legislation. It has in the meantime received significant reinforcement in the form of numerous statutory instruments and two significant administrative provisions – Technical Instructions on Air Quality Control (TA Luft) and Technical Instructions on Noise Abatement (TA Lärm). The TA Luft is a comprehensive air pollution control regulation that includes:

- A discussion of the scope of the TA Luft application, which is to review applications for licenses to construct and operate new industrial facilities (or altered existing facilities) and to determine whether the proposed new or altered facilities will comply with the requirements of the TA Luft and the requirements of other air pollutant emission regulations promulgated under the Federal Pollution Control Act.
- Air pollutant emission limits for dust, sulfur dioxide, nitrogen oxides, hydrofluoric acid and other gaseous inorganic fluorine compounds, arsenic and inorganic arsenic compounds, lead and inorganic lead compounds, cadmium and inorganic cadmium compounds, nickel and inorganic nickel compounds, mercury and inorganic mercury compounds, thallium and inorganic thallium compounds, ammonia from farming and livestock breeding operations, inorganic gases and particulates, organic substances and others.
- Emission limits may also be set for hazardous, toxic, carcinogenic or mutagenic substances as part of the TA Luft review procedures.
- Other limits or requirements related to stack heights (for flue gases or other process vents) and for storing, loading or working with liquid or solid substances.
- Various requirements for sampling measuring and monitoring emissions.
- Listing of the industries subject to the requirements of the TA Luft, such as mining, electric power generation, glass and ceramics, steel, aluminum and other metals, chemical plants, oil refining, plastics, food, and others.

Annex 3 is devoted to guidelines on: how the atmospheric dispersion modeling required during the TA Luft review is to be performed, and the acceptable type of dispersion model to be used. In essence, the modeling must be in accordance with the VDI Guidelines 3782 Parts 1 and 2, 3783 Part 8, 3784 Part 2, and 3945 Part 3.

*17th Ordinance for the implementation of the Federal Immission control Act (Ordinance on Incineration Plants for municipal waste and similar combustible substances)*

The 17<sup>th</sup> Ordinance for the implementation sets the regulatory framework for the special case of the municipal waste incinerators based on the general requirement of the Federal immission control Act and the TA Luft. The Air emissions standards which have been set as the basis for the project (DBO) are *similar to the EU-IED and in some cases more stringent*

*VDI (German Engineer Association) Guideline 3945 part 3 “Environmental meteorology/Atmospheric dispersion models –Particle model” of September 2000*

The Commission on Air Pollution Prevention of the VDI and DIN – Standards Committee, which includes experts from science, industry and administration, acting independently, establish VDI guidelines and DIN standards in the field of environmental protection. These describe the state of the art in science and technology in the Federal Republic of Germany and serve as a decision-making aid in the preparatory stages of legislation and the application of legal regulations and ordinances. KRdL’s working results are also considered as the common German point of view in the establishment of technical rules at the European level by CEN (the European Committee for Standardization) and at the international level by ISO (the International Organization for Standardization). This guideline describes a numerical model for simulating the dispersion and calculating the concentrations of trace species in the atmosphere. Data required for the model include the mean wind field, turbulence parameters, emission data and, depending on the specific case, further application-specific input data.

### **3.4 Guidance note**

*Latest IFC General EHS Guideline, page 3-17 “Air emission and ambient air quality”*

The Environmental, Health, and Safety (EHS) Guidelines are technical reference documents with general and industry-specific examples of Good International Industry Practice (GIIP). These General EHS Guidelines are designed to be used together with the relevant Industry Sector EHS Guidelines which provide guidance to users on EHS issues in specific industry sectors. The EHS Guidelines contain the performance levels and measures that are generally considered to be achievable in new facilities by existing technology at reasonable costs. Page 3-17 applies to facilities or projects that generate emissions to air at any stage of the project life-cycle. It complements the industry-specific emissions guidance presented in the Industry Sector Environmental, Health, and Safety (EHS) Guidelines by providing information about common techniques for emissions management that may be applied to a range of industry sectors. This guideline provides an approach to the management of significant sources of emissions, including specific guidance for assessment and monitoring of impacts. It is also intended to provide additional information on approaches to emissions management in projects located in areas of poor air quality, where it may be necessary to establish project-specific emissions standards.

*Latest IFC EHS Guideline for Waste management facilities page 8-10 and 29-30*

The proposed WtE will involve a state of the art management of MSW generated from the Zone III waste catchment area (GM and other atolls and resorts) through waste incineration and sanitary landfill disposal of residual waste and is likely to be driven by IFC Sector EHS Guidelines on Waste Management Facilities. The guideline outlines significant EHS issues associated with waste management facilities during operations and decommissioning phases along with recommendations for mitigating the identified impacts. The applicability of these guidelines with respect to specific waste management operation including the current waste management practices has been discussed in details below.

Presently waste received at the Thilafushi is dumped in an uncontrolled manner with intentionally or non-intentionally burning leading to emission of pollutants (VOCs, dioxins & furans, particulate matter, acid fumes, SO<sub>x</sub>, NO<sub>x</sub>, etc.) which are expected to result in the deterioration of ambient air quality and occupational health. Hence in line with IFC Sectoral EHS requirements the ambient air quality needs to be periodically monitored by the proponent to check conformance with WHO Ambient Air Quality Guidelines, 2005.

Air pollutant emissions are also envisaged during the operation of waste incineration to be commissioned as an integral part of the proposed Thilafushi WtE. Carbon dioxide, Sulfure dioxide, particulate matter etc. have been identified as the key air pollutants that are likely to be released by waste incineration. High temperature maintained within the combustion furnace of the plant generally limits/restricts the formation of toxic substances viz. dioxins/furans, NO<sub>x</sub>, SO<sub>x</sub> and CO. Hence in accordance to the provision of the IFC EHS Guidelines it is necessary to undertake periodic monitoring of such emissions to review the performance of these proposed waste management systems against national & internationally recognized standards. However in absence of specific standards catering to emissions from Incineration plants in Maldives, project will be designed and operated in accordance with the substantive provisions of the following guidelines: "Air Emission Standards for MSW Incinerators in the EU & US" (Refer Appendix 4.1) and respective EU and German legislation. These regulations establish the minimum standards that must be met by facilities; specifically, emission levels for various pollutant materials: organics (dioxins, furans), metals (cadmium, lead and mercury), particulate matter (opacity), acid gases (hydrogen chloride, sulfur dioxide, nitrogen dioxide) and fugitive gas emissions.

#### *IFC Performance standard*

This section specifies the environmental monitoring requirements and assesses the compliance to the applicable national and international EHS guidelines/standards with respect to the current waste management practices and proposed Thilafushi RWMF as defined under relevant provisions of the applicable IFC Performance Standards.

#### *PS3: pollution prevention & abatement*

PS3 identifies the contribution of industrial activity and urbanization towards increased levels of pollution to air, water, and land that may threaten people and the environment at the local, regional, and global level. This performance standard therefore aims towards avoidance and minimization of the adverse impacts on human health and environment by addressing the pollution from project activities.

Paragraph 9 of the PS requires the proponent to undertake periodic monitoring of pollutants appropriate to the nature and scale of the potential impacts to demonstrate compliance with applicable national regulations and evaluate project environmental performance to determine corrective actions, if any. For project involving pollutant emissions Paragraph 26 and 27 of the PS requires the proponent to evaluate whether the existing background ambient levels are in compliance with the relevant national or internationally recognized ambient quality guidelines and/or standards so that adequate control measures can be put in place to prevent significant deterioration of environment quality and demonstrate continual improvement.

As the proposed Thilafushi Waste Management Project will involve emissions of air pollutants (CO<sub>2</sub>, CO, NO<sub>x</sub>, SO<sub>x</sub>, PM, VOCs, dioxins/furans, etc.) and noise from operation of the plant and vehicles involved in waste handling and





transportation, generation of leachate landfill facilities there may exist potential risks on ambient environment, occupational and community health from such operations if not properly managed. Hence it is imperative that a monitoring framework is developed and implemented during the project operations stage to periodically assess and evaluate the performance of key HSE indicators to regularly check conformance with applicable national and international standards/guidelines (*WHO Ambient Air Quality Standards*, IFC Waste Management Facility EHS Guidelines, etc.) for necessary corrective action, if any.

Further in line with provisions of PS1, primary monitoring has been undertaken for physical components (ambient air) to establish the baseline environment and check for any possible deterioration in ambient environment.

## 4 Methodology

This air quality report was carried out in accordance with the TA Luft and established good practice for air quality modelling and assessment. The study considered emissions from the WtE stack and the Diesel Genset controlled under the 17<sup>th</sup> Ordinance of the German Federal Immission Control act and the Industrial Emissions Directive (2010/75/EU). In summary, the substances to be assessed are set out in the table below. For the sake of clarity a comparison table with Table 1 of the IFC HES sector guideline for MSW facilities (standard guideline for ADB) has been developed. The values in blue are the values used for this project.

Table 1 Air emission standards for MSW Incinerators in the EU and US as per IFC EHS sector guideline Waste management Facilities page 29			17. Ordinance for the Implementation of the Federal Immission Control Act (Germany)
Parameter	EU	USA <sup>a</sup>	
Total Suspended particulates (PM <sub>10</sub> )	10 mg/m <sup>3</sup> [24 hr average]	20 mg/dscm	5 mg/m <sup>3</sup> [24 hr average] 20 mg/m <sup>3</sup> [0,5 hr average]
Total Carbon (C)			10 mg/m <sup>3</sup> [24 hr average] 20 mg/m <sup>3</sup> [0,5 hr average]
Sulfur Dioxide (SO <sub>2</sub> )	50 mg/m <sup>3</sup> [24 hr average]	30 ppmv (or 80% reduction)	50 mg/m <sup>3</sup> [24 hr average] 200 mg/m <sup>3</sup> [0,5 hr average]
Oxides of Nitrogen (NO <sub>x</sub> )	200-400 mg/m <sup>3</sup> [24 hr average]	150 ppmv [24 hr average]	150 mg/m <sup>3</sup> [24 hr average] 400 mg/m <sup>3</sup> [0,5 hr average]
Opacity	n/a	10%	n/a
Hydrochlorid Acid (HCl)	10 mg/m <sup>3</sup>	25 ppmv (or 95% reduction)	10 mg/m <sup>3</sup> [24 hr average] 60 mg/m <sup>3</sup> [0,5 hr average]
Dioxins and furans	0,1 ng TEQ/m <sup>3</sup> [6-8 hr average]	13 ng/dscm (total mass)	n/a
Cadmium*	0,05-0,1 mg/m <sup>3</sup> [0,5-8 hr average]	0,010 mg/dscm	n/a
Carbon Monoxide (CO)	50-150 mg/m <sup>3</sup>	50-150 ppmv <sup>c</sup>	50 mg/m <sup>3</sup> [24 hr average] 100 mg/m <sup>3</sup> [0,5 hr average]

Table 1 Air emission standards for MSW Incinerators in the EU and US as per IFC EHS sector guideline Waste management Facilities page 29			17. Ordinance for the Implementation of the Federal Immission Control Act (Germany)
Parameter	EU	USA <sup>a</sup>	
Lead (Pb)*	See total metals below	0,140 mg/dscm	n/a
Mercury (Hg)	0,05-0,1 mg/m <sup>3</sup> [0,5-8 hr average]	0,050 mg/dscm (or 85% reduction) <sup>b</sup>	0,03 mg/m <sup>3</sup> [24 hr average] 0,05 mg/m <sup>3</sup> [0,5 hr average]
Total metals*	0,5-1 mg/m <sup>3</sup> [0,5-8 hr average]	n/a	n/a
Hydrogen Fluoride (HF)	1 mg/m <sup>3</sup>	n/a	1 mg/m <sup>3</sup> [24 hr average] 4 mg/m <sup>3</sup> [0,5 hr average]
Ammonia (NH <sub>3</sub> )	n/a	n/a	10 mg/m <sup>3</sup> [24 hr average] 15 mg/m <sup>3</sup> [0,5 hr average]

<sup>a</sup> All values corrected to 7% oxygen <sup>b</sup> Whichever is less stringent

\*Actually as there were no requirements for heavy metals (including lead) and cadmium this was not considered. The Consultant has contacted his sub-contractor due undertake additional assessment of these pollutants

It could be seen that values considered in this report for PM<sub>10</sub>, NO<sub>x</sub>, Mercury (Hg) are more stringent than EU-IED values. Additional parameters like Ammonia (NH<sub>3</sub>), Total Carbon (C) (*in the TA luft but not in the IED*) and dioxin and furans (*in the IED but not in the TA Luft*) have been considered.

#### 4.1 Ambient air quality/Existing conditions

Actually the Maldives does not have an Air quality monitoring surveying network. Therefore ambient air quality has been assessed through a temporary field survey.

Baseline Air quality monitoring was conducted at four locations: 3 locations at Thilafushi (AQ1, AQ2, and AQ3) and one location at Villingili (AQ4) by Water Solutions. In 2018, air quality monitoring was carried out at AQ3 at Thilafushi from 20th to 26th June 2018. In 2019, air quality monitoring was carried out at AQ4 at Villingili from 3rd to 9th March 2019, at AQ1 from 19th to 25th March 2015. Additional air quality monitoring was carried at AQ2 from 20th to 25th August 2019 and at AQ3 from 25th to 31st August 2019.

One station was selected in the downwind direction of the WtE stack emission plume while another station was placed at the cross wind direction of the plume. One station was selected in the cross wind direction of the smoke plume from the existing dump site at Thilafushi. The additional station at Vilingili was selected as a control site.

The instrument used for taking air quality for baseline is the Aeroqual series 500 monitors and sensors. Aeroqual is a portable monitor suited for surveying common indoor and outdoor pollutants compatible with over 30 different sensors. The Series 500 can be deployed for short term fixed monitoring by

adding an optional outdoor enclosure. The Aeroqual Series 500 is also highlighted as the leading instrument for measuring ozone, nitrogen dioxide and carbon monoxide by the United States Environmental Protection Agency (US EPA).



**Figure 1:** Air Quality monitoring station with two Aeroqual Series 500 monitors

Predominant wind direction is an important criteria in selection of the air quality sampling stations as gaseous and particulate emissions from the project activities have a greater chance of dispersal along the predominant wind direction and affect the downwind human habitations. The monitoring network for ambient air quality was developed based on the following key criteria;

- Regional meteorology (primarily wind speed and direction)
- Important receptor locations (e.g. nearby inhabitation);
- Proposed project activities
- Logistics for operating the air monitoring equipment

The predominant wind directions in Maldives are dependent on the NE and SW monsoons. The wind directions for all seasons recorded at the National Meteorological Centre, Maldives reveal that apart from the winter months (when winds primarily blow from NW-NE), winds predominantly blow from the west.

The ambient air quality monitoring locations are shown in and rationale for selection of the locations is presented in [Table 1](#).

**Table 1:** Locations for ambient air quality monitoring

Station Name	Station Coordinates	Monitoring rationale
<i>Thilafushi</i> Downwind (AQ1)	4°10'56.6 N 73°26'53.3 E	This downwind station with respect to the proposed facility has been selected to establish the baseline that could be compared with the monitoring to be undertaken during the construction and operational phases of the project to detect actual project imprints to the air quality of the nearest receptor.
<i>Thilafushi</i> crosswind (AQ2)	4°10'57.3 N 73°25'59.4 E	The cross wind station with respect to the proposed facility has been selected to establish the general baseline of the island, for comparison with the downwind station at the time of project activities

Station Name	Station Coordinates	Monitoring rationale
<i>Thilafushi crosswind (AQ3)</i>	4°11'07.6 N 73°26'37.4 E	The cross wind station with respect to the existing dumpsite at the Thilhafushi has been selected to establish the general baseline of the island
<i>Viligili Island (AQ4)</i>	4°10'26.4 N 73°28'59.9 E	The cross wind station with respect to Thilhafushi has been selected as a control site and to detect project imprints to air quality of the nearest receptor due to trans-island transportation of pollutants

The exact location of the ambient air stations were selected by WS/Kocks on site personnel to ensure the stations experience free air flow and are established at height between 1.5-5 meters and comply with the rationale of the monitoring program.

Selection of the sampling stations was based on the general climatological data obtained from the National Meteorological Center, Maldives. Also, data for the predominant wind directions for the sampling period was obtained from the National Meteorological Centre Maldives. As the direction of flow of exhaust air will be affected with changing wind directions, predominant exhaust air directions were noted down several times during the sampling program.

Because of the location of the island, strong gusts and variations of wind directions were noted which have the potential to influence the dispersion and in turn affect the air sampling. As a result it was thought pertinent to systematically record wind direction and strong gust.

Summary of the parameters measured:

Station	Parameters	Date	Frequency of recording
AQ 1	PM <sub>10</sub>	19.03.2019-20.03.2019	Minutely (24 hrs)
	PM <sub>2,5</sub>	19.03.2019-20.03.2019	Minutely (24 hrs)
	NO <sub>2</sub>	20.03.2019-21.03.2019	Minutely (24 hrs)
	CO	22.03.2019-23.03.2019	Minutely (24 hrs)
	CH <sub>4</sub>	21.03.2019-22.03.2019	Minutely (24 hrs)
	CO <sub>2</sub>	19.03.2019-20.03.2019	Minutely (24 hrs)
	H <sub>2</sub> S	20.03.2019-21.03.2019	Minutely (24 hrs)
	SO <sub>2</sub>	22.03.2019-23.03.2019	Minutely (24 hrs)
	VOC	21.03.2019-22.03.2019	Minutely (24 hrs)
AQ2	CO <sub>2</sub>	25.08.2019-26.08.2019	Every 15 min (24 hrs)
	CO	26.08.2019-27.08.2019	Every 15 min (24 hrs)
	NO <sub>2</sub>	27.08.2019-29.08.2019	Every 15 min (24 hrs)
	PM <sub>2,5</sub>	25.08.2019-26.08.2019	Every 15 min (24 hrs)
	PM <sub>10</sub>	25.08.2019-26.08.2019	Every 15 min (24 hrs)

Station	Parameters	Date	Frequency of recording
AQ 3	PM <sub>10</sub>	20.06.2018-24.06.2018	Every 10 min (96 hrs)
	PM <sub>2,5</sub>	20.06.2018-24.06.2018	Every 10 min (96 hrs)
	SO <sub>2</sub>	20.06.2018-24.06.2018	Every 10 min (96 hrs)
	CO <sub>2</sub>	25.08.2019-26.08.2019	Every 15 min (24 hrs)
	CO	26.08.2019-27.08.2019	Every 15 min (24 hrs)
	NO <sub>2</sub>	28.08.2019-29.08.2019	Every 15 min (24 hrs)
	PM <sub>10</sub>	25.08.2019-26.08.2019	Every 15 min (24 hrs)
	PM <sub>2,5</sub>	25.08.2019-26.08.2019	Every 15 min (24 hrs)
AQ 4	SO <sub>2</sub>	06.03.2019-10.03.2019	Minutely (96 hrs)
	NO <sub>2</sub>	06.03.2019-10.03.2019	Minutely (96 hrs)
	PM <sub>10</sub>	06.03.2019-10.03.2019	Minutely (96 hrs)
	Pm <sub>2,5</sub>	06.03.2019-10.03.2019	Minutely (96 hrs)
	CH <sub>4</sub>	06.03.2019-10.03.2019	Minutely (96 hrs)
	CO	06.03.2019-10.03.2019	Minutely (96 hrs)



Figure 2: Location of Ambient air quality monitoring station (Source Google earth)

## 4.2 Air dispersion modelling (ADM)

### 4.2.1 Rationale

The dispersion modelling for the pollutants was carried out using the dispersion model AUSTAL2000. The computer program AUSTAL2000 is a reference implementation developed on behalf of the *German Federal Environmental Agency*. (Available as a free download at <https://www.umweltbundesamt.de/themen/luft/regelungen-strategien/ausbreitungsmodelle-fuer-anlagenbezogene/austal2000n-download>)

AUSTAL2000 is a steady-state dispersion model that is designed for long-term sources and continuous buoyant plumes. AUSTAL2000 is also capable of using multiple point, area, volume, and line sources. This model includes dry deposition algorithms and considers the conversion of nitric oxide (NO) to nitrogen dioxide (NO<sub>2</sub>). It is also able to make predictions about the frequency of odour nuisance.

It also available in English version as it is used by *other EU-member states*

The program system AUSTAL2000 calculates the spread of pollutants and odours in the atmosphere. It is an extended implementation of Annex 3 of the German regulation TA Luft (Technical Instruction on Air Quality Control) demands for dispersion calculations a Lagrangian particle model in compliance with the German guideline VDI 3945 Part 3. The modelling work was carried out by Ulbricht Consulting (Germany). The dispersion modelling report is attached as an Annex to this report.

Steady-state Gaussian plume models assess pollutant concentrations and/or deposition fluxes from a variety of sources associated with an industrial source complex. *Unlike the Gaussian models* commonly used, this flexible modelling procedure used in AUSTAL2000 *provides realistic results even when buildings and uneven terrain influence flue gas dispersion*. The model calculates the contribution of specified air pollutants from a given point source to the background concentrations present in the ambient air at ground level in the area surrounding the source.

### 4.2.2 Comparaison AUSTAL2000 vs AERMOD<sup>1</sup>

Unlike the Gaussian dispersion model AERMOD, AUSTAL2000 is a Lagrangian dispersion model that simulates the dispersion of air pollutants by utilizing a random walk process. According to Sawford<sup>2</sup> a Lagrangian simulation *has greater potential for application* as it mimics the behaviour of particles. The direction and velocity of dispersion are estimated by wind field vectors. Additionally, the vector of the turbulent velocity is randomly varied for every particle by using a Markov process. The random element varies with the intensity of turbulence. The concentration is determined by counting the particles in a given volume<sup>3</sup>

<sup>1</sup> Christian Langner & Otto Klemm (2011) A Comparison of Model Performance between AERMOD and AUSTAL2000, Journal of the Air & Waste Management Association, 61:6,640-646, DOI: 10.3155/1047-3289.61.6.640

<sup>2</sup> Sawford, B.L. Lagrangian Statistical Simulation of Concentration Mean and Fluctuation Fields; J. Climate Appl. Meteorol. 1985, 24, 1152-1166.

<sup>3</sup> Guideline 3945, Part 1. Environmental Meteorology—Atmospheric Dispersion Models—Particle Model; Verein Deutscher Ingenieure: Düsseldorf, Germany, 2000.



Like AERMOD, AUSTAL2000 is capable of calculating terrain and contains its own algorithm to assess the effects of building downwash<sup>4</sup>. AUSTAL2000 does not differentiate between rural or urban areas. AUSTAL2000 requires *less meteorological* information than AERMOD: z0, wind measurement height, wind direction, wind speed, and the stability classes according to Klug–Manier. The Klug–Manier classes represent the German standard stability classification for the atmosphere, similar to the Pasquill stability classes<sup>5</sup> in the United States. All of these meteorological data come from ground-based measurements and no information from upper air soundings is utilized. The wind measurement height and z0 are provided in the input file. If z0 is not provided by the user, AUSTAL2000 will calculate it using an internal database of roughness lengths and the coordinates of the area. AUSTAL2000 uses the register of roughness lengths and the integrated wind field component TALdia, which creates wind field libraries for complex terrain and for cases with buildings.

AERMOD generally predicted concentrations closer to the field observations. AERMOD and AUSTAL2000 performed considerably better when they included the emitting power plant building, indicating that the downwash effect near a source is an important factor. Both models performed acceptable for a no buoyant volume source. AUSTAL2000 had difficulties in stable conditions, resulting in severe underpredictions. This analysis indicates that AERMOD is the stronger model compared with AUSTAL2000 in cases with complex and urban terrain.

Generally speaking, the analysis indicates that AERMOD is the stronger model compared with AUSTAL2000 in complex and urban terrain. *In cases with simple terrain*, both models lead to acceptable results. Given the specific conditions and scope of the investigation, a model user has to evaluate whether he/she can get the meteorological data required to operate AERMOD. *For cases of poor meteorological data coverage, AUSTAL2000 could be an alternative*

#### 4.2.3 Comparaison AUSTAL2000 vs CALPUFF<sup>6</sup>

Given the same quality of meteorological data, the performance of AUSTAL is similar to that of CALPUFF when using the Kincaid data set. The AUSTAL predictions tend to be conservative, usually overestimating the Kincaid GLC by roughly a factor two. AUSTAL performance is strongly affected by the choice of “quality factor” parameter, which controls the stochastic variability through the number of particles released. AUSTAL also tends to underestimate the wind speed at elevated levels, but AUSTAL predictions *are greatly improved when wind data at an elevated level* (close to the elevated source) is provided. AUSTAL predictions are improved when the thermal properties of exhausted gas from a power plant are described by the *VDI thermal flux equation*.

#### 4.2.4 Conclusion

The computer program AUSTAL2000 is a reference implementation developed on behalf of the German Federal Environmental Agency. It is also used by other EU-state members and is a state of the art model following international good practice. AUSTAL2000 is a Lagrangian dispersion model that simulates the

<sup>4</sup> AUSTAL2000—Program Documentation of Version 2.4; Janicke Consulting: Dunum, Germany, 2009.

<sup>5</sup> Pasquill, F. The Estimation of the Dispersion of Windborne Material; Meteor. Mag. 1961, 90, 33-49

<sup>6</sup> Ka-Hing Yau, Robert W. Macdonald & Jesse L. Thé (2011), inter-comparison of the austrial2000 and calpuff dispersion models against the kincaid data set, 9th Int. Conf. on Harmonisation within Atmospheric Dispersion Modelling for Regulatory Purposes

dispersion of air pollutants by utilizing a random walk process, with a particular strong performance in simple terrain and with poor meteorological data coverage. The model requires less meteorological information than similar models (AERMOD, etc.) which, given the circumstances and the environment in Maldives, makes it probably more suitable to generate a reliable output.

#### 4.2.5 Grid

The stack height of has been set for the ADM to min 46 m (Worst case/see stack height calculation). Therefore the ADM area has a radius of at least 2,300 m (50 times the stack height). The grid for the calculation of concentration and deposition shall be selected in accordance with Chapter 7 (2) of Annex 3 of the Technical Instruction "Air" so that the location and contribution of the maximum emission can be determined with sufficient certainty. This is usually the case when the horizontal mesh size does not exceed the stack height. At source distances greater than 10 times the height of the stack, the horizontal mesh size can be selected proportionally larger. The calculations and assessments were carried out in an area of 3.2 x 2.6 km and a grid with mesh sizes of 5 to 20 m.

#### 4.2.6 Potential sensitive locations/Assessment points

In the examination area, two assesment points were determined for the calculations. The location of these points can be found in Annex 3. BUP 1 (west) is the point with the maximum load. ANP 1 (East) has been considered for additional mercury load dispersion calculation. These points are also nearby the baseline ambient air survey points.

#### 4.2.7 Level of uncertainty

The resulting statistical uncertainty (in %) was taken into account in the evaluation. The calculation was performed with the quality level "2". To assess the emissions, the calculated value is increased by the statistical uncertainty.

#### 4.2.8 Meteorology

##### 4.2.8.1 *Rainfall, Temperature, atmospheric pressure*

The rainfall over the Maldives varies during the two monsoon periods with more rainfall during the southwest monsoon. These seasonal characteristics can be seen from [Figure 3](#), which shows the mean monthly rainfall observed for central atolls.

The average annual rainfall for the archipelago is 2,124 mm. There are regional variations in average annual rainfall: southern atolls receive approximately 2,280 mm, and northern atolls receive approximately 1,790 mm annually (MEE, 2015). Mean monthly rainfall also varies substantially throughout the year with the dry season getting considerably less rainfall. This pattern is less prominent in the southern half, however. The proportions of flood and drought years are relatively small throughout the archipelago, and the southern half is less prone to drought (UNDP, 2006).

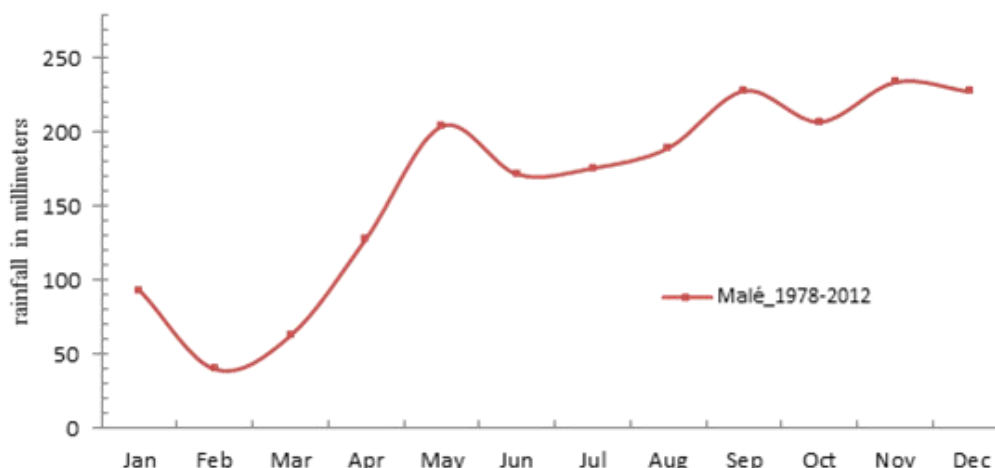


Figure 3: Long term average rainfall for the central atolls (Source: Maldives Meteorological Service, 2016)

For the ADM the following meteorological data have been acquired and used

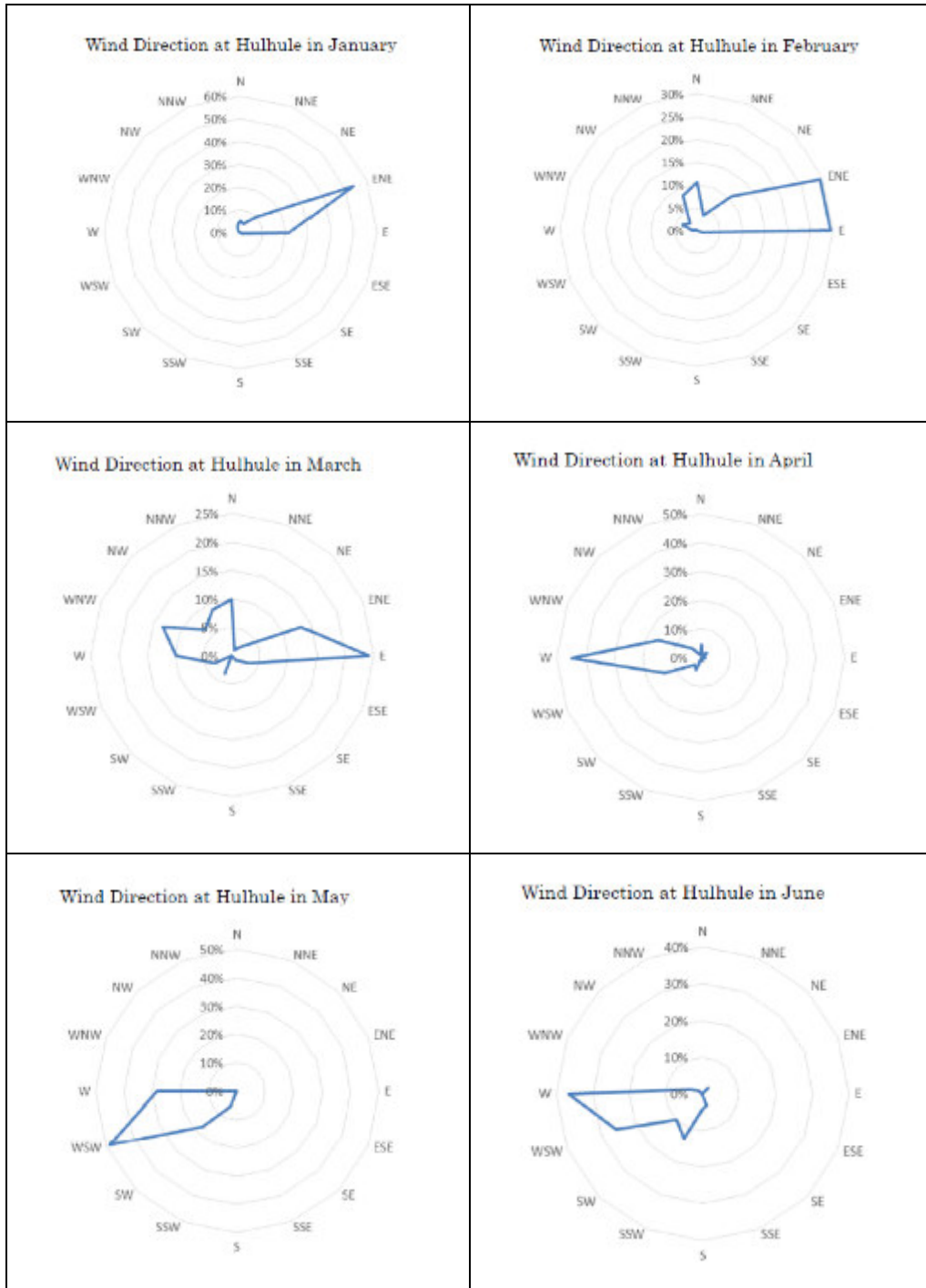
Rainfall data set (daily)	Source : Maldives Meteorological service Location : Weather station Hulhule' (Airport) at 10 km East of Thilafushi Data set: from 08.1974-12.2017
Temperature data set (daily)	Source : Maldives Meteorological service Location : Weather station Hulhule' (Airport) at 10 km East of Thilafushi Data set: from 01.-12.2017
Atmospheric pressure data set (daily)	Source : Maldives Meteorological service Location : Weather station Hulhule' (Airport) at 10 km East of Thilafushi Data set: from 01.-12.2017

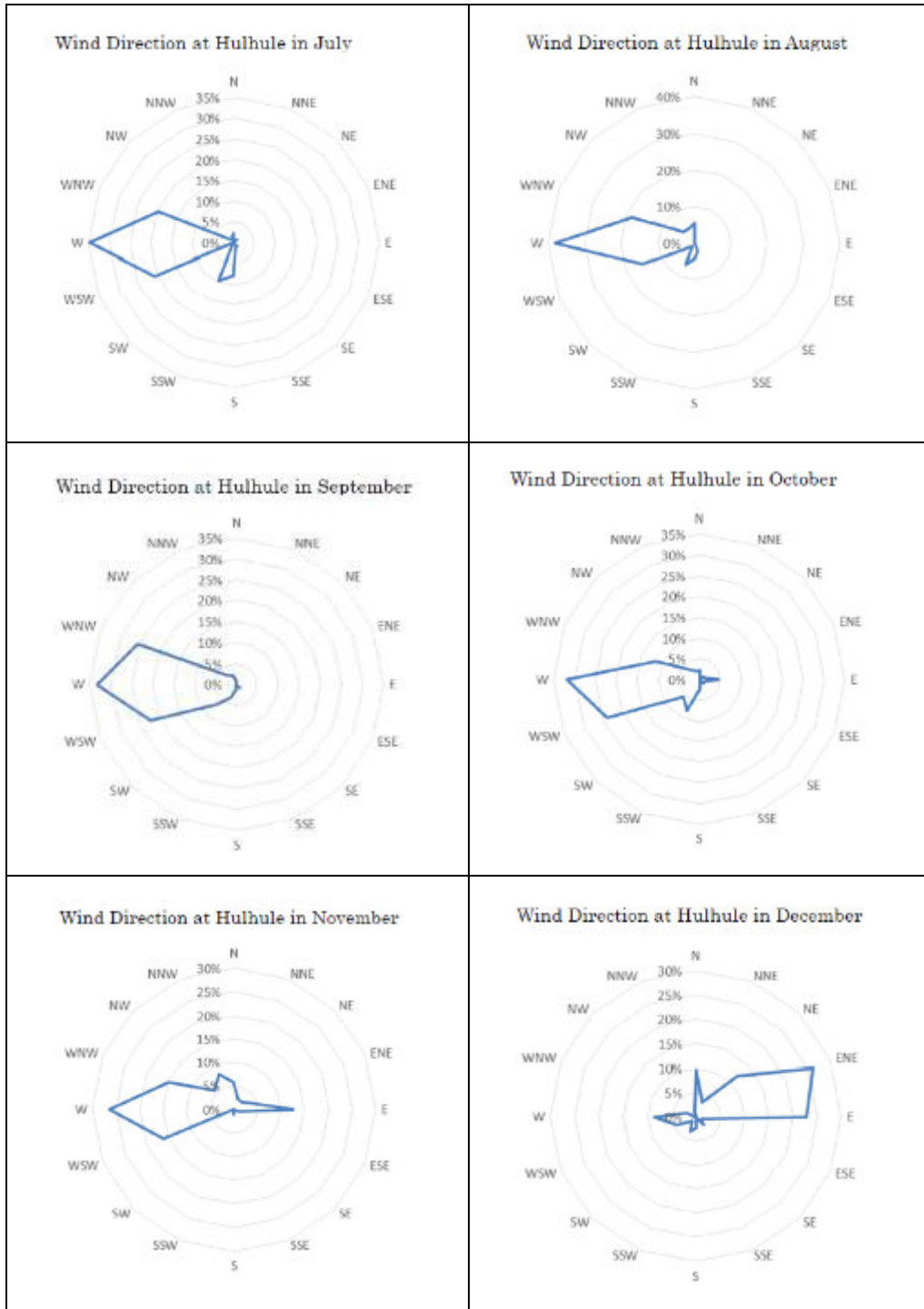
The data set have been provided in Excel format and have been computed for the purpose of the model in AKterm format.

#### 4.2.8.2 Wind

The prevailing wind over the Maldives represents typical Asian monsoonal characteristics. It follows the traditional definition of monsoon as seasonal reversal of wind direction by more than 120° between the months January and July. Looking at annual variations, westerly winds are predominant throughout the country, varying between west-southwest and west-northwest *Figure 4*.

The southwest monsoon, with winds predominantly between SW and NW, lasts from May to October. In May and June, winds are mainly from WSW to WNW, and in July to October, winds between W and NW predominate. The northeast monsoon, with winds predominantly from NE to E, lasts from December to February. During March and April, winds are variable. During November, winds are primarily from the west, becoming variable and can occasionally exceed 30 knots from the NE sector. However, yearly wind speed in the northeast and southwest monsoons are observed to be between 9-13 knots.





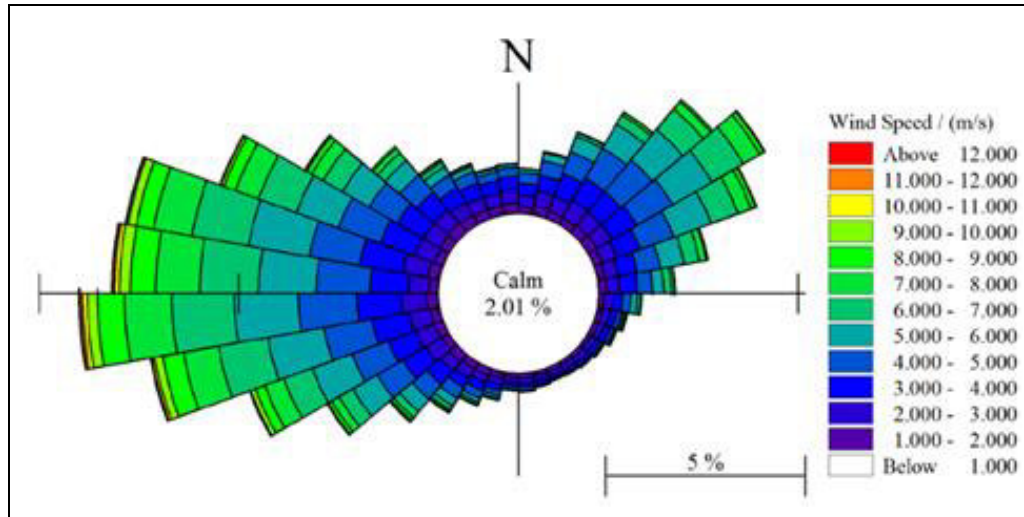


Figure 4: Spatial distribution of wind speed and directions from 1986-2016 (Source: LHI, 2018)

*Figure 5* illustrates clearly wind the distribution pattern in terms of direction and frequency. The length of the “slices” represents the percentage of occurrence while the colour code illustrates wind speed. Furthermore, Table 15 shows the occurrence of wind by values in different directions and various speeds. According to the analysis, two dominant wind directions can be observed; i.e. West and North-East. The wind from the South-East quadrant is negligible. Significantly, calm conditions are rare, occurring 2.01% of the time.

Dir (Deg N) Speed (m/s)	Dir (Deg N)																																Total					
	0-10	10-20	20-30	30-40	40-50	50-60	60-70	70-80	80-90	90-100	100-110	110-120	120-130	130-140	140-150	150-160	160-170	170-180	180-190	190-200	200-210	210-220	220-230	230-240	240-250	250-260	260-270	270-280	280-290	290-300	300-310	310-320		320-330	330-340	340-350	350-360	
0-1	0.03	0.08	0.06	0.05	0.06	0.07	0.06	0.04	0.09	0.03	0.03	0.05	0.04	0.06	0.05	0.04	0.05	0.08	0.03	0.06	0.07	0.06	0.06	0.06	0.07	0.08	0.11	0.03	0.08	0.07	0.08	0.06	0.07	0.06	0.06	0.03	2.07	
1-2	0.17	0.24	0.20	0.21	0.24	0.26	0.21	0.19	0.20	0.14	0.14	0.14	0.10	0.12	0.10	0.10	0.11	0.12	0.11	0.16	0.19	0.18	0.24	0.21	0.23	0.24	0.30	0.23	0.30	0.23	0.27	0.29	0.27	0.24	0.23	0.18	7.07	
2-3	0.29	0.38	0.43	0.48	0.44	0.45	0.43	0.35	0.34	0.23	0.19	0.16	0.15	0.14	0.13	0.11	0.11	0.13	0.12	0.17	0.19	0.28	0.32	0.40	0.51	0.53	0.64	0.53	0.64	0.54	0.48	0.45	0.39	0.34	0.31	0.29	12.16	
3-4	0.31	0.40	0.57	0.67	0.67	0.72	0.60	0.49	0.42	0.24	0.19	0.16	0.13	0.10	0.09	0.09	0.09	0.08	0.08	0.16	0.22	0.27	0.44	0.65	0.73	0.98	1.10	0.95	1.13	0.92	0.77	0.58	0.41	0.38	0.35	0.26	16.39	
4-5	0.26	0.38	0.58	0.86	1.03	1.05	0.90	0.61	0.37	0.20	0.18	0.08	0.07	0.03	0.04	0.04	0.05	0.09	0.08	0.13	0.20	0.31	0.48	0.75	0.97	1.28	1.48	1.36	1.31	1.11	0.82	0.55	0.38	0.29	0.21	0.19	18.62	
5-6	0.10	0.19	0.42	0.68	0.89	1.13	1.00	0.58	0.30	0.16	0.06	0.05	0.03	0.03	0.03	0.01	0.04	0.05	0.04	0.07	0.11	0.21	0.41	0.70	1.07	1.40	1.63	1.45	1.51	1.15	0.75	0.48	0.23	0.14	0.09	0.08	17.39	
6-7	0.02	0.04	0.09	0.26	0.69	0.90	0.72	0.39	0.19	0.06	0.05	0.03	0.02	0.01	0.00	0.01	0.02	0.01	0.03	0.04	0.06	0.11	0.20	0.40	0.76	1.24	1.56	1.49	1.43	0.96	0.57	0.25	0.12	0.07	0.03	0.02	12.89	
7-8	0.00	0.01	0.03	0.08	0.23	0.47	0.35	0.18	0.08	0.03	0.03	0.02	0.01	0.01				0.01	0.02	0.02	0.02	0.06	0.09	0.21	0.50	0.90	1.18	1.07	0.98	0.62	0.33	0.15	0.05	0.03	0.00	0.01	7.78	
8-9		0.00	0.03	0.02	0.05	0.12	0.11	0.04	0.01	0.01	0.02	0.00						0.01	0.00	0.01	0.02	0.04	0.09	0.25	0.52	0.65	0.62	0.43	0.30	0.14	0.04	0.03	0.02				3.60	
9-10				0.02	0.04	0.05	0.03	0.00	0.00	0.00	0.00									0.00	0.01	0.01	0.02	0.12	0.21	0.24	0.28	0.21	0.08	0.04	0.01	0.00					1.39	
10-11						0.00	0.01															0.01	0.00	0.01	0.03	0.06	0.13	0.12	0.06	0.02	0.02	0.00					0.47	
11-12																										0.01	0.02	0.08	0.04	0.02	0.01	0.00	0.01					0.18
12-13																										0.01	0.01	0.04	0.01	0.01	0.01	0.00						0.09
13-14																								0.00			0.01	0.01										0.02
14-15																											0.00											0.00
15-16																													0.00									0.00
Total	1.18	1.70	2.42	3.33	4.41	5.22	4.42	2.86	2.00	1.12	0.81	0.69	0.54	0.51	0.44	0.41	0.47	0.58	0.51	0.81	1.08	1.53	2.28	3.60	5.26	7.42	9.13	8.22	8.09	6.03	4.27	2.89	1.95	1.56	1.28	1.06	100	

Figure 5: Directional Distribution of Wind Statistics (% Occurrence for Wind Speed vs. Wind Direction)

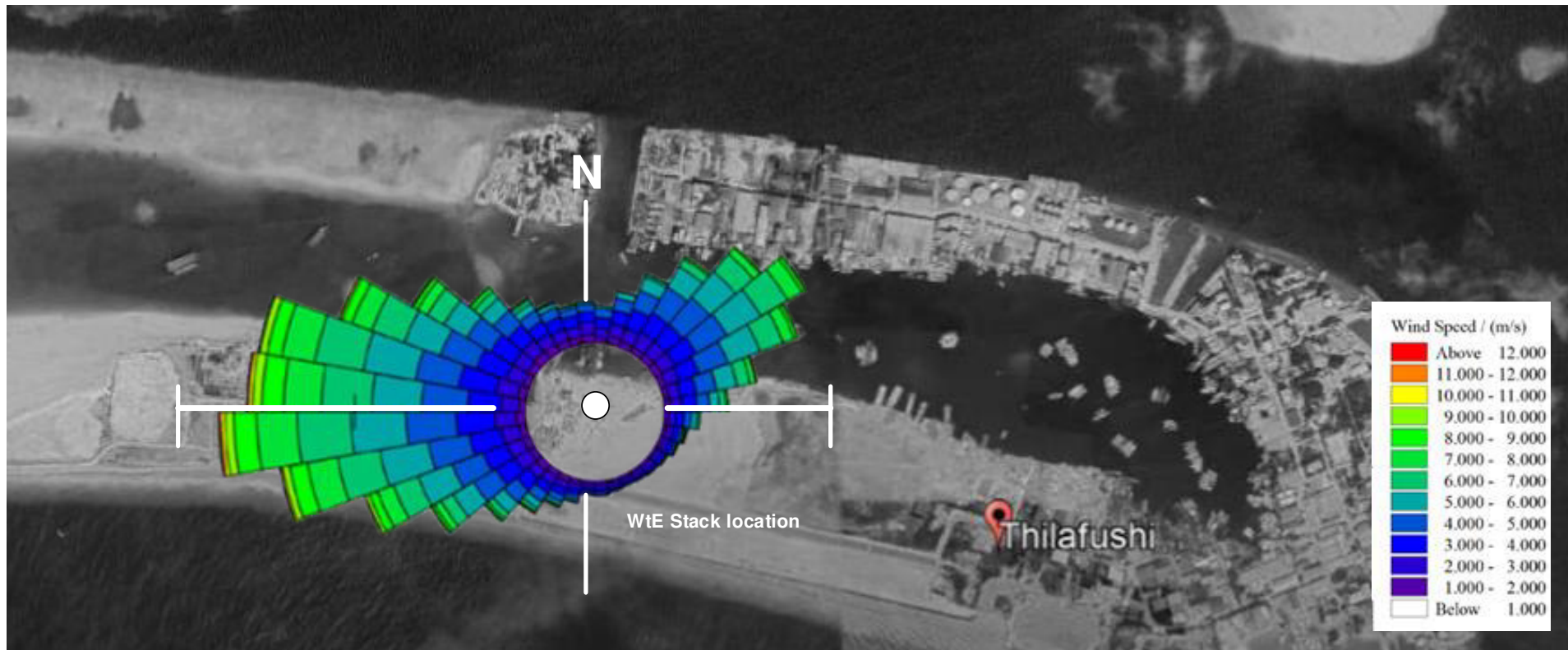


Figure 6: average Wind rose over project location



Besides the annual monsoonal wind variations, there are occasional tropical storms in the central region of the Maldives which increases wind speeds up to 110 km/h, precipitation to 30 to 40 cm over a 24 hour period and storm surges up to 3 m in the open ocean (UNDP, 2006).

For the ADM the following hourly wind data set have been acquired and used

Wind data set (hourly)	Source : Maldives Meteorological service Location : Weather station Hulhule' (Airport) at 10 km East of Thilafushi Data set: from 01.-12.2017 (24 hrs/day) Wind measurement height $z_0$ : 11,5 m over ground level
Dispersion class time series	The wind direction distribution and the wind speeds were modelled with a dispersion class time series for the year 2017 <sup>7</sup> .

The data set have been provided in Excel format and have been computed for the purpose of the model in AKterm format.

#### 4.2.9 Topography

All islands of the Maldives are very low lying; more than 80% of the land area is less than 1 m above mean high tide level (MEEW, 2005). Combined with the small size of the islands, this means that accelerated sea level rise will have devastating effects on the islands and threatens the very existence of all the islands of the Maldives.

The proposed site for the establishment of the WtE was reclaimed in 2018. 15 hectares of land was reclaimed from the shallow lagoon which was located on either side of the link road that was constructed at Thilafushi. The materials for the reclamation was borrowed from North Male' Atoll with a radius of 10 km from Thilafushi using a Trailing Suction Hopper Dredger (TSHD). The dredger borrowed the material for the reclamation from borrow sites were within a depth range of 40-50m. The material from the dredger was discharged to the reclamation area via a floating pipe line which ran from the sea floor to the reclamation area, which was bunded with sand bunds, from southern side of the reclamation area.

The site has been reclaimed to a height of +1.5 m from MSL from an average depth of -1.5 m above the sea floor. The sand grains are angular to sub-angular in shape with gravel size varies from 20 – 30 mm in diameter and fairly uniformly graded. It can be described as loosely packed, silty, coral sand with pieces of corals and shells. Since the area had been recently reclaimed, the site does not have humus topsoil which is found on typical tropical islands. The soils have very high permeability for water. Much of the rainfall occurs as intense storms but no signs of erosion is observed, confirming high infiltration capacity.

The entire Island and the project location are mainly on the main level over MSL and don't present any substantial elevation (only the actual dumpsite is culminating at approx. 15 m over MSL). The following figure present the actual site configuration

<sup>7</sup> Wind data provided by Maldives Meteorological Services



Figure 7: areal picture of reclaimed area for WtE Facility

Ground roughness	The ground roughness of the terrain is described by an average roughness length $z_0$ . It is determined according to the land use classes of the CORINE Cadastre. The roughness length was chosen within the calculation to be $z_0 = 0.2$ . This value should be considered as representative for the area of calculation.
Terrain and slope	It is a flat terrain. In the computing area, no gradients of more than 1:20 or even more than 1:5 occur.

#### 4.2.10 Building effects

Influence of buildings have been also considered in the model. The following building dimension and location (stack and Diesel genset) have been considered for the WtE facility.

WtE dimensions: Approx. Length x width x height [m]: 100 x 70 x 30

Surrounded buildings location have been considered according land use plan, topographical survey and google earth maps. The height of the buildings have been considered to maximum 10 m.

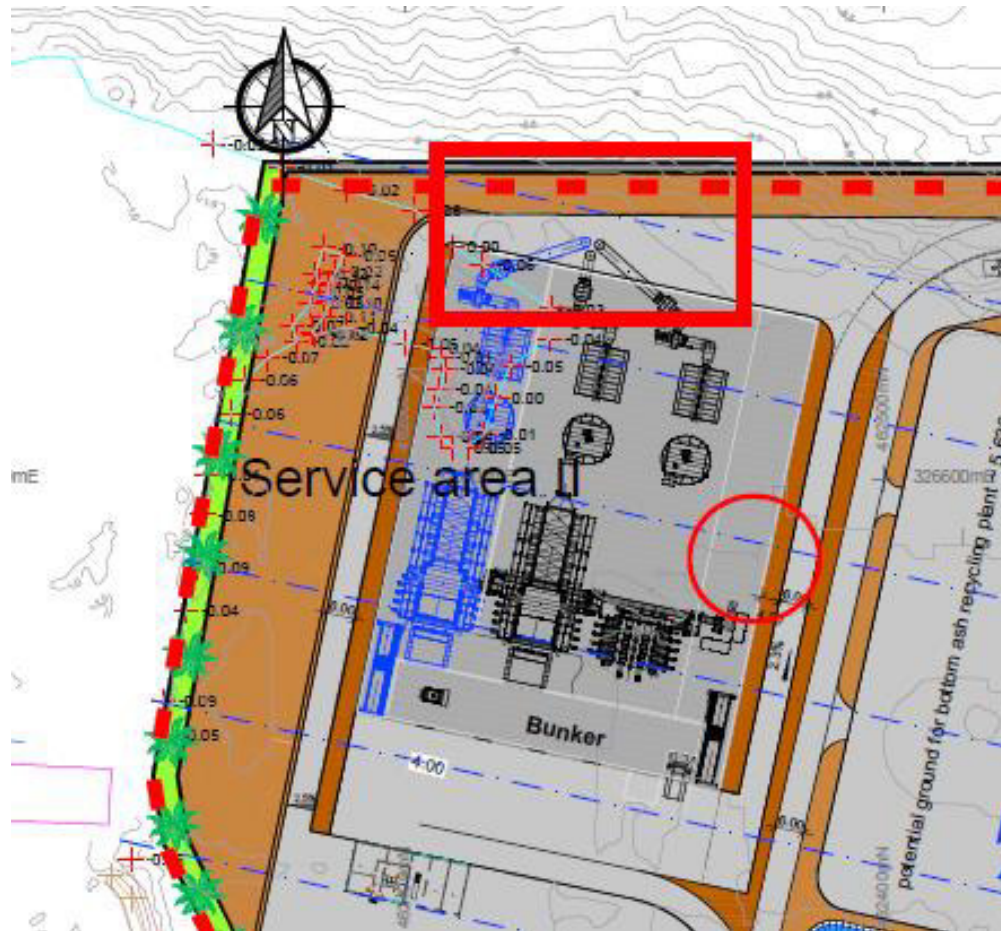


Figure 8: tentative Location of the WtE, the stack (square) and the genset (circle)

#### 4.2.11 Emissions

The following parameter have been provided to the consultant for the ADM

Location of the stack	4.183004 N; 73.437155 E	
Number of stacks	2	
Stack height above ground level	46 m for ADM (Stack height will be fixed to 50 m for DBO)	
Distance between stacks	7 m (to be considered as 1 single source)	
Equivalent diameter	2.12 m	
Operation hrs WtE/Stack	8,000 hrs/year	
Flue gas volume flow	Stack 1	Stack 2
	57,856 m <sup>3</sup> /h	57,856 m <sup>3</sup> /h
Flue gas temperature	180°C	
Location of Genset	4.182394 N; 73.437370 E	
Number of Genset	1	

Distance between Genset and stack	Approx. 150 m
Operation hours Genset	760 h/year (only emergency/Island mode)
Flue gas volume flow Genset	12.470 Nm <sup>3</sup>
Emissions (based on 11% O <sub>2</sub> in the flue gas)	
Total dust	5 mg/Nm <sup>3</sup>
PM <sub>10</sub>	0,5 mg/Nm <sup>3</sup>
Total carbon	10 mg/Nm <sup>3</sup>
HCl	10 mg/Nm <sup>3</sup>
Hf	1 mg/Nm <sup>3</sup>
SO <sub>2</sub>	50 mg/Nm <sup>3</sup>
NO <sub>x</sub>	150 mg/Nm <sup>3</sup>
Hg	0,03 mg/Nm <sup>3</sup>
CO	50 mg/Nm <sup>3</sup>
NH <sub>3</sub>	10 mg/Nm <sup>3</sup>
Dioxin/furan	0,1 ng/Nm <sup>3</sup>

## 5 Assessment criteria

### 5.1 Criteria to protect human health

The Technical Instruction provides Immision rate/ambient air concentration values for the concentration of substances above which risks to human health are expected (paragraph 4.2) or they cause considerable nuisance or considerable disadvantages (Section 4.3). significant drawbacks, in particular protection of vegetation and ecosystems (Section 4.4) and harmful environmental effects by pollutant depositions (section 4.5) as well as irrelevant additional burdens, the compliance of which, according to Number 4.1 the TA Luft, can eliminate the determination of the total load, if the threshold are not respected

The following tables show the Immision rate/ambient air concentration values specified in the TA Luft as well as the irrelevant additional loads for the WtE plant relevant pollutants.

Table 2: Immission rate/ambient air concentration values and irrelevant values according Nr. 4.2 of the TA Luft

Substance/group of substances	Immision rate/ambient air concentration values	Average period	Allowed exceeding frequency per year	Irrelevant additional load
Protection of human health - Emission values according N° 4.2 TA Luft				
Aerosol (PM <sub>10</sub> )	40 µg/m <sup>3</sup>	year	-	1.2 µg/m <sup>3</sup>
	50 µg/m <sup>3</sup>	24 hours	35	-
Sulfur dioxide (SO <sub>2</sub> )	50 µg/m <sup>3</sup>	year	-	1.5 µg/m <sup>3</sup>
	125 µg/m <sup>3</sup>	24 hrs	3	-
	350 µg/m <sup>3</sup>	1 hr	24	-
Nitrogen dioxide (NO <sub>x</sub> )	40 µg/m <sup>3</sup>	year	- 18	1.2 µg/m <sup>3</sup>
	200 µg/m <sup>3</sup>	1 hr		-

## 5.2 Criteria to protect ecological sites

Table 3: Immission rate/ambient air concentration values and irrelevant values according Nr. 4.3 - 4.5 of the TA Luft

Substance	Ambient air quality value	Averaging period	Irrelevant additional load
Protection against considerable nuisance or major drawbacks due to dust precipitation - Ambient air quality values according to number 4.3 TA Luft			
Dust precipitation (non-hazardous dust)	0.35 g / (m <sup>2</sup> · d)	year	0.0105 g / (m <sup>2</sup> · d)
Protection against nuisances, in particular protection of vegetation and ecosystems - Ambient air quality values according to 4.4 TA Luft			
Ammonia	Whether the protection against nuisances and drawbacks by damage of sensitive plants (eg nurseries, crop plants) and ecosystems by the effect of ammonia is guaranteed, is to be examined according to number 4.8 TA Luft.		
Protection against harmful environmental effects through pollutant deposition - Ambient air quality values according to number 4.5 TA Luft or protection against considerable disadvantages according to number 4.4 TA Luft			
Mercury and its inorganic compounds, expressed as mercury	1 µg / (m <sup>2</sup> · d)	year	0.05 µg / (m <sup>2</sup> · d)
Hydrogen fluoride and gaseous inorganic fluorine compounds, indicated as fluorine	0.4 µg / m <sup>3</sup>	year	0.04 µg / m <sup>3</sup>
Arsenic and its inorganic compounds, expressed as arsenic	4 µg / (m <sup>2</sup> · d)	year	0.2 µg / (m <sup>2</sup> · d)

Substance	Ambient air quality value	Averaging period	Irrelevant additional load
Lead and its inorganic compounds, indicated as lead	100 µg / (m <sup>2</sup> · d)	year	5 µg / (m <sup>2</sup> · d)
Cadmium and its inorganic compounds, expressed as cadmium	2 µg / (m <sup>2</sup> · d)	year	0.1 µg / (m <sup>2</sup> · d)
Nickel and its inorganic compounds, expressed as nickel	15 µg / (m <sup>2</sup> · d)	year	0.75 µg / (m <sup>2</sup> · d)
Thallium and its inorganic compounds, reported as thallium	2 µg / (m <sup>2</sup> · d)	year	0.1 µg / (m <sup>2</sup> · d)

## 6 Determination of significance of effects

According to the TA Luft calculated emission loads were assessed against the relevant critical loads fixed in the regulation. Only for the loads which are over the critical load (minimum mass flow) an detailed air dispersion model is required. For the purpose of the determination of the significance of effects and the need of a detailed ADM the following parameters have been considered:

- Total suspended material/dust expressed as PM10
- Sulphur oxide and dioxide expressed as Sulphur dioxide (SO<sub>2</sub>)
- Nitrogen oxide (NO<sub>x</sub>)
- Ammonia (NH<sub>3</sub>)
- And mercury (Hg).

In the present case, the emissions are calculated with the calculation program for all relevant pollutants, insofar as emission values are specified for these substances in the TA Luft

For the other relevant pollutants: total C, carbon monoxide (CO), hydrogen chloride, dioxins and furans, no emission values are specified in the TA Luft.

## 7 Baseline conditions

### 7.1 Project location (Macrolocation)

The development of the proposed project takes place at Thilafushi. Thilafushi is located in North Male' atoll, 9.5km from Male'. In terms of geographic coordinates, it is located at 04° 11' 00" N and 73° 26' 44" E. The nearest inhabited island is Villingili, approximately 7.1 km east of Thilafushi. The reef system is approximately 4.65 km long, 0.94 km wide (width of ring reef, including the lagoon area). A newly reclaimed Industrial Island (Gulhi Fahlu) is approximately at 650 m from the eastern tip of the Thilafushi and the nearest resort (Centar Ras Fushi) at more than 3,2 km on the North-West of the Island.

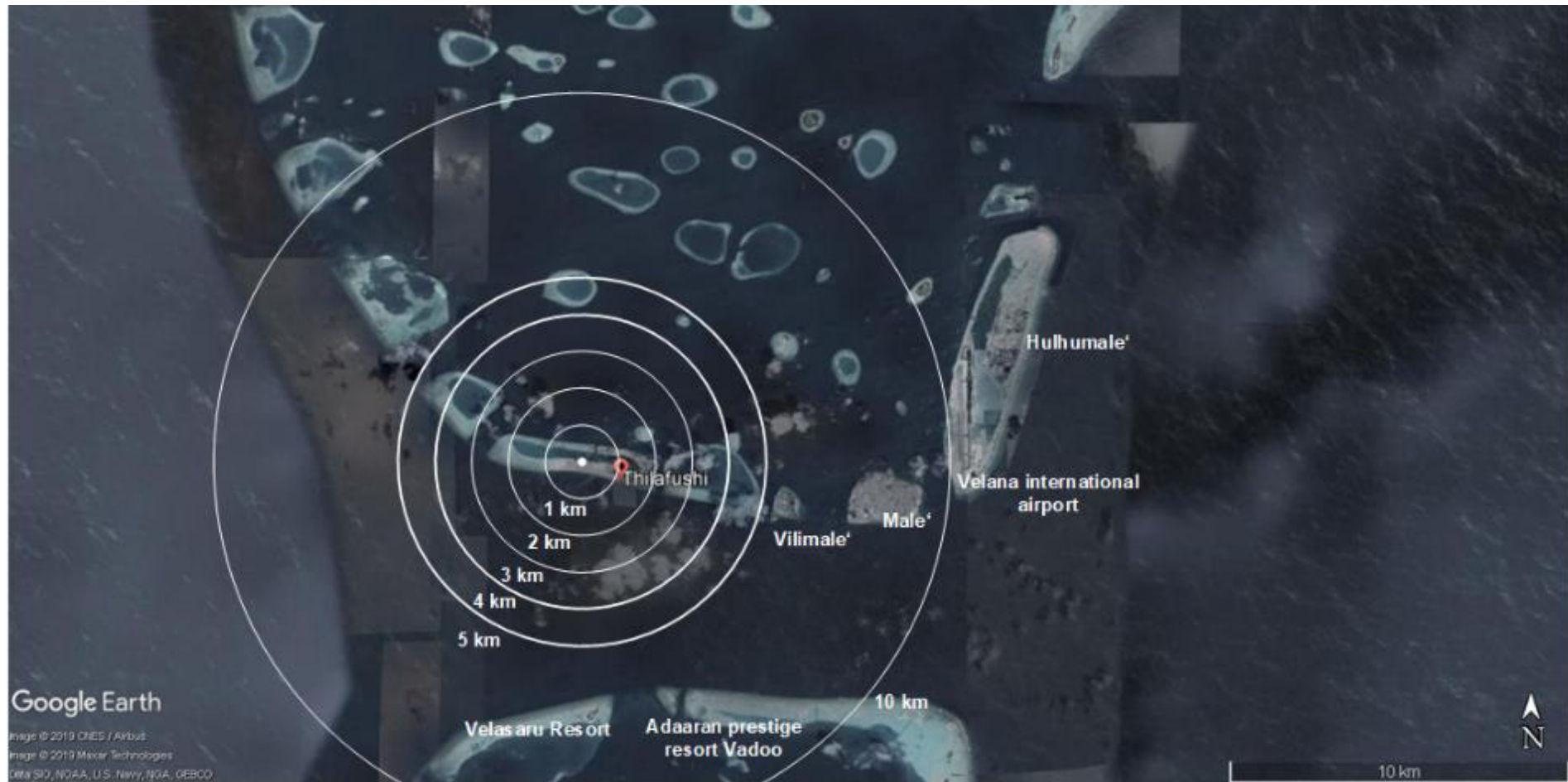


Figure 9: Project location (macro-location) [Source Google Earth]



Figure 10: Project location (Meso-location, distances from tentative stack location of the WtE) [Source google Earth]





Thilafushi Island has been developed as a solid waste land fill since December 1992. The island was initially developed as a sand bank using dredged material from the Thilafushi Reef. Since then, land has been reclaimed by placing solid waste in dredged holes on the reef flat and later topping it up with fresh lagoon sand. The island referred to as Thilafushi-1 was and is being reclaimed using this method.

A second island, zoned as Thilafushi-2, was reclaimed from lagoon sand to meet the demand. Subsequently a third island, Thilafushi-3, was initiated to reclaim 167 Ha of land from the remaining reef areas of Thilafushi.

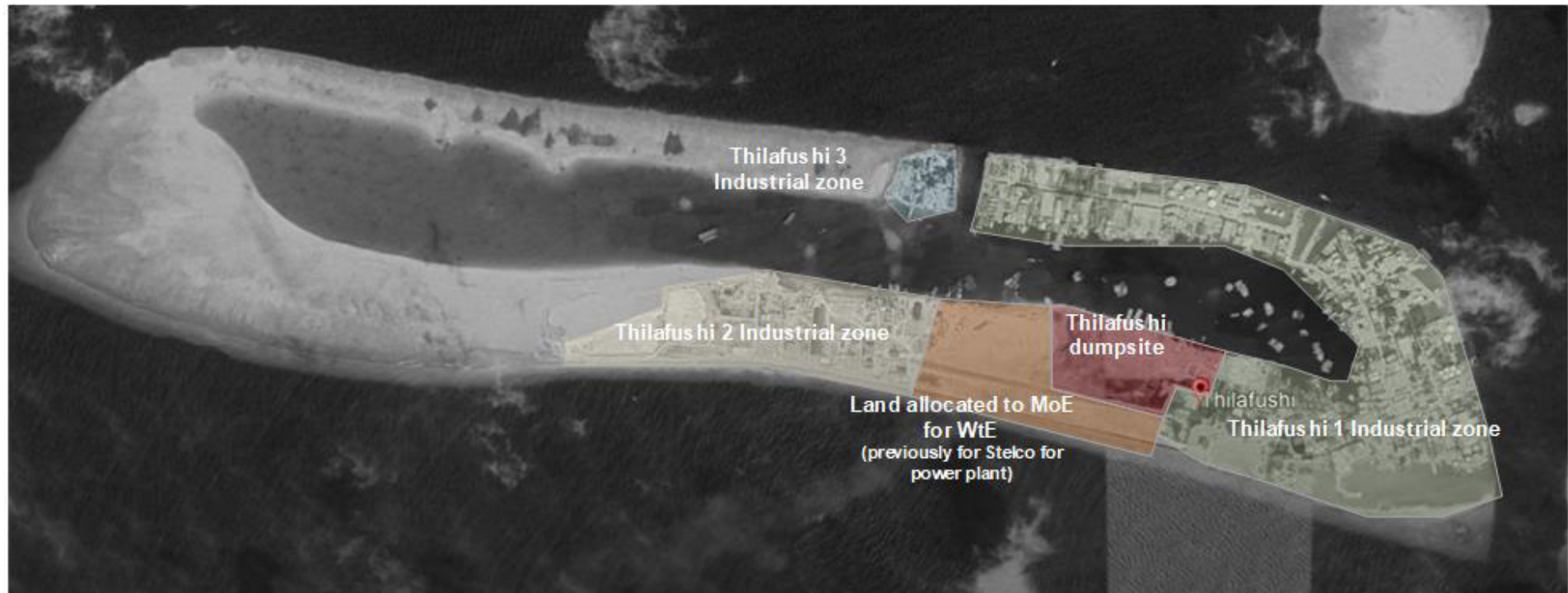


Figure 11: land use plan [developed by given land use plan and Google Earth Image]

Name	Thilafushi Island
History	1992 lagoon became dumpsite by filling with waste and sand. Development of the site by land reclamation through waste and sand dumping
Coordinates	4°11'N 73°26'E
Dimensions	Length : approx. 3.50 km Width: approx. 0.20 km
Vocation	Industrial Island
Population	Registered people (workers) Approx. 2,052 workers 2,048 male, 04 female, no children, 69 % Foreigners (international migrants) Approx. 1,500 residents (one base camp) Others relocated in Guli Fahlu
Borders/Boundaries	Island surrounded by seawater
Nearest Island	Guli Fahlu at 2,081 km from WtE stack (650 m from edge of Thilafushi), Industrial Island and workers camp
Nearest Resort or inhabited Island	Centar Ras fushi resort at 3,20 km (from WtE stack)
Vegetation	Basic vegetation, after landscaping measure, no rare or endangered species, no high vegetation
Tourism	None
Industry	Boat building Cement conditioning Construction companies' base/storage sites Methane gas bottling Storage of goods Water bottling Small industry (RO plants, etc.)
Facilities	Customs Small police and fire station Ferry station

Table 4: Summary of Thilafushi project location (macro-location)

## 7.2 Project location (Microlocation)

The coordinates of the project location are 4°10'54.49"N 73°26'24.38"E. The establishment of RWMF for Zone 3 at Thilafushi requires 15 hectares which have been reclaimed from the adjacent shallow lagoon. Figure 12 illustrates the location of the project.



Figure 12: Project location (micro-location)

Name	Waste to Energy facility Thilafushi
Description of the components	Waste acceptance area with weighbridge Waste bunker with crane Waste incineration (grate technology) with 3 combustion chambers Boiler Flue gas cleaning and stack Residual waste treatment : bottom ash treatment plant Residual waste disposal: residual waste (fly ash conditioned in big bags) state of the art landfill Buildings and facilities (admin, storage, maintenance, water supply, sewerage, electricity, firewater, stormwater, etc..)
Coordinates	North West: 4°10'58.73"N, 73°26'11.51"E North East: 4°10'58.87"N, 73°26'22.20"E South West: 4°10'50.71"N, 73°26'9.74"E South East: 4°10'48.09"N, 73°26'20.87"E
Borders/boundaries	North: Lagoon East: Old dumpsite West: New reclaimed industrial area South: Open sea
Contract	Design-Build Operate Contract for 20 years
Actual stage	Preliminary design and Tender documents for DBO contractor
Project site	Newly reclaimed area (no waste) with compacted coarse sand North side (lagoon) closed by a concrete quay wall with a height of 1,5 m over MSL South side is closed by a coastal shore protection of rock boulders and a separation liner of a geotextile with an average height of 2,0 over MSL
Vegetation	No vegetation actually, landscaping measures foresee in the DBO
Activity	None (WtE later stage)
Ambient air quality	No activities/negligible
Surface water	Lagoon seawater on the north of the site Open seawater at the Southside
Groundwater	Brackish seawater (after land reclamation)

Table 5: Summary of project location (Micro-location WtE plant)

### 7.3 Component of the WtE facility

The WtE facility shall be designed and built as a conventional state-of-the-art grate type incinerator of two lines of 250 Mg/d each (total of 500 Mg/d), that shall consist of the following main set of process units and plant components:

- a) Waste reception, storage and feeding consisting of a weigh bridge incl. guard house, tipping hall and waste bunker, a shredder and waste cranes;
- b) Thermal treatment consisting of combustion system; boiler and heat recovery system and boiler feed water and make-up water system;
- c) Air pollution control system and ID fan and stack and continuous emission monitoring system (CEMS)
- d) Turbine with generator and condenser, cooling water pre-treatment system and cooling water pumps,
- e) Other balance of plant components incl. fuel and chemicals supply and storage; fire-fighting water supply system; waste water treatment plant for sewerage, water supply system;
- f) Bottom ash treatment plant incl. bottom ash bunker and conveying system;
- g) Residue sanitary landfill and leachate collection, management and treatment system;
- h) Electric system incl. connection to public network

All process units and the balance of plant components are to be equipped with the necessary electrical and control components, with valves, fittings, piping, utility mains etc. and shall be combined to a fully functional system that is fit for purpose and that is operated and controlled by a DCS which shall facilitate monitoring and recording of operational data.

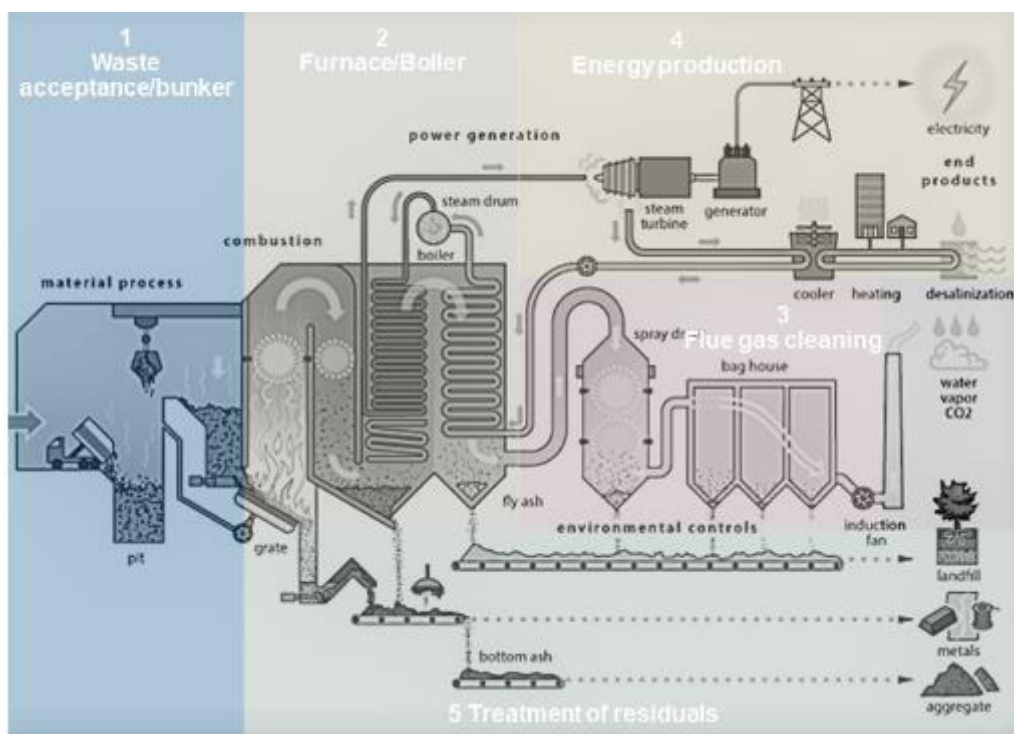


Figure 13: schematic layout of the WtE Facility

These process units are accommodated by the following buildings, housings and civil constructions:

- a) Waste reception/guard house
- b) Tipping hall
- c) Waste bunker
- d) Machinery hall and steam turbine housing
- e) Housing for the bottom ash processing plant
- f) Administration block incl. control room and visitors' center
- g) Workshop

#### h) Housing of the leachate treatment plant

The WtE facility shall be designed and built to allow the extension of the plant by a third line of 250 Mg/d (to reach a total of 750 Mg/d)

To operate the facility the following infrastructure needs also to be realised:

- Water supply, electricity supply (emergency Genset), sewerage system
- Roads, carriageways and sidewalks
- Cooling water inlet and outlet structure
- Storm water drainage system
- Landscaping
- Fencing

All infrastructural elements shall be incorporated into the buildings and process units to allow an easy operation and maintenance of all facilities.

The residual waste from the waste incineration is bottom ash, slag and the residues from flue ash. Bottom ash and slag is a valuable fraction which may potentially be used for many purposes: as covering material for landfill, as a ballast layer or reinforcement layer in road construction or as a filler/aggregate for construction blocks. A bottom ash processing plant is also part of the facility

The residues from the flue gas cleaning (fly ash) are hazardous and need to be dumped in a controlled way on a sanitary landfill after being conditioned safely in sealed big bag.

#### 7.3.1 Stack height

The stack height has been established through the use of modelling services engaged for the EIA. The assessment was done with reference to standards applied for air quality control in Germany, as set out in an instruction document with legal standing in Germany, TA Luft. The stack height required to comply with the technical instruction was determined, following which predictions of concentrations of pollutants in the emissions from the WtE were predicted, and dispersion modelling undertaken for those exceeding a designated minimum level.

Determination of the requisite stack height was undertaken using a nomogram and calculation steps provided in the German TA Luft. The input values for this process are the inside diameter of the stack, the temperature of the waste gas at the mouth of the stack, the volume of flow of the waste gas in standard conditions after subtraction of the water vapour content, and the rate of emission mass flow of the air pollutants from the plant. In determining these parameters, a feed of 500 tons of household waste per day was assumed. The final stack height is determined based on the dimensions of adjoining buildings.

A stack height of minimum 45.7m would have sufficient dilution of the exhaust gases and an undisturbed transport with the free air flow is ensured.

With a view to alleviate the potential air quality impacts at critical air sensitive receivers (ASRs) but at the same time to minimize potential visual impact associated with a tall stack, 50m is selected as the stack height for the RWMF at Thilafushi. It has considered the air quality benefit and visual impact due to a relatively tall stack in a small island geographic setting. The cleaned and cooled gases from the gas cleaning system are discharged into a stack. The gases are discharged by means of an induced drafted fan.

### 7.3.2 Cooling system

The heat energy of the exhaust air from the furnace is transmitted to water, converting the water to high pressure steam. The high pressure steam is used to rotate a steam turbine and generate electricity. After the electricity generation process, steam pressure is reduced and the steam is further cooled down by a cooling system. The proposed cooling system uses a seawater cooled condenser and involves exchange of the heat of the low pressure steam to sea water, which is then discharged to the sea from south side of Thilafushi.

### 7.3.3 Bottom ash treatment

The DBO-Contractor shall be responsible for designing and building the bottom ash processing plant including bottom ash storage to satisfy the requirements of the envisaged bottom ash reuse. Subject to the design considerations of the DBO Contractor an intermediate bottom ash storage shall be provided. The floor of the bottom ash storage hall shall allow run-off from the wet bottom ash via a drainage system. The drained run-off from the bottom ash storage area shall be forwarded after either mechanical or gravity cleaning to buffer tanks prior to the leachate treatment system. The intermediate bottom ash storage area shall be sized to accommodate short term stoppages in the conveying system (e.g. the overhead cranes and belt conveyors).

Table 6: Design parameters for Bottom ash treatment plant

<b>Bottom ash Handling System (design parameter)</b>	
Ash content in SW (dry ash/wet)	Max. 35%
Water content in bottom ash downstream extractor	Max. 15%
Capacity	Min. 160% of the maximum bottom ash flow
<b>Boiler &amp; Fly ash transport system</b>	
Boiler hopper ash and air pollution control system fly ash shall be collected from each boiler, economizer, and air pollution control system hopper with drag conveyors, screw conveyors, or a pneumatic conveying system to conditioning the fly ash into big bags. After conditioning the fly ash shall be deposited into the landfill cell. Provisions will be made to prevent dusting during transfer to a disposal truck. The big bags shall be fully enclosed and dustproof and located in the residue building before transport	
Boiler ash and fly ash drag conveyors, screw conveyors, or pneumatic system shall be completely dust-tight to prevent leakage of fly ash.	

### 7.3.4 Residual waste landfill

The DBO Contractor's shall design the residual waste landfill complying with the following criteria:

- The landfill arrangement shall be designed to maximise the useable landfill volume of the Site;
- The landfill cell arrangements shall be designed to allow for the progressive closure of individual landfill cells on completion and thereby to minimise the amount of leachate requiring treatment over the lifetime of the landfill;



- The design shall allow for the development of individual cells in a coherent and logical sequence and in a manner which ensures the stability of all working faces and of the waste mound as a whole.
- The design shall incorporate appropriate back-up systems in the event of failure of any component of the environmental control and management systems;
- The landfill concept shall be designed to minimise the lateral and vertical extent of the working face and thereby the amount of deposited waste that is exposed to the environment;
- The design shall ensure that waste can be deposited in a manner that prevents damage to the engineered barrier or liner, the leachate control system, and the collection and transfer system.
- The landfill design shall incorporate an internal access corridor to allow for safe traffic movement and to accommodate site services and monitoring devices;
- Measures shall be provided for controlling unauthorised access to the landfill including, as appropriate, the provision of ditches, berms, planting and fencing;
- Slopes shall be graded to ensure long term slope stability. Graded slopes shall be a maximum of 25%;
- Soil erosion and dust generation shall be minimised;
- All landfill construction materials shall be free of organic matter and debris;
- Measures shall be provided to monitor and manage groundwater beneath and adjacent to the landfill area;

The Contractor's design shall include surface water and storm water collection and diversion systems in order to protect the landfill area and minimise the generation of leachate. Sedimentation ponds shall be established to contain polluted drainage and runoff containing soil and sediment.

The Contractor's design shall include an engineered barrier to prevent leachate contamination of surface water and groundwater. The barrier shall comply with the following:

- The hydraulic conductivity of the barrier shall be no greater than the equivalent of  $1 \times 10^{-9}$  metres per second.
- The level of the engineered barrier shall be no deeper than 1.5 metres above mean sea level and in accordance with the applicable environmental standards;

All components of the leachate collection, extraction, transfer and treatment system shall be capable of being maintained in a clean condition to ensure effective operation. Concentrate shall be re-injected in the flue gas treatment process of the WtE. The Contractor shall design and build or organise a system for the safe collection, transport and re-injection of the LTP concentrate.

### 7.3.5 Electricity generation

The heat produced during the incineration process will be recovered and used for electricity generation. The electricity generated from the incineration process will be used to support the normal operation of the facilities within the RWMF. Surplus energy will be exported to other users via the existing electricity grids maintained by the State Electric Company (STELCO). The supply of process steam and electrical energy for the side shall take place via combined heat and power.

### 7.3.6 Layout arrangement

The RWMF has been designed to provide long term environmentally sustainable solution for waste management in Zone 3 of the Maldives. Limitations and scarcity of land and the requirement to protect the fragile ecosystem have also been considered during the design of RWMF. With a view to minimize the land use and the associated environmental impacts, the preferred location for the RWMF was the area around the old dumpsite of Thilafushi. This has the advantage to reduce environmental risks on another location and islands, and to conduct the dumpsite rehabilitation in parallel. The vocation of Thilafushi as an industrial island plays also in favour of a site location of the facility on this island.

The layout for the RWMF is considered appropriate, taking into consideration the functional need for operation of the RWMF, reasonable flexibility in design for the DBO contractor and allowance of suitable size of land for provision for the future. The design of the RWMF has been done considering factors such as waste composition, quantity reaching RWMF, applicability in the local condition and regulatory compliance.

## 7.4 Ambient Air quality/Baseline survey

Air quality monitoring for baseline was conducted by Water Solutions at Thilafushi (and Villingili). Three locations were selected at Thilafushi and one location at Villingili for baseline Air quality monitoring in 2018 and 2019 (see chapter methodology). The Principal objective of the ambient air quality monitoring is to assess background environment status and to check the conformity to the applicable standards of ambient air quality. Despite rapid increase in sources of air pollutants and associated diseases there is no national standard for air quality or regulations to control air emission in the Maldives (MEE, 2017). In the absence of any National Ambient Air Quality Standards, the WHO guidelines were considered to assess the air quality.



**Figure 14:** View around AQ4 (Villingil) on 3rd March 2019

On each sampling day, 1 set of 24-hour average samples were collected continuously.  $PM_{10}$ ,  $PM_{2.5}$ , Sulphur dioxide ( $SO_2$ ) and Oxides of nitrogen ( $NO_2$ ) were measured by sampling continuously during the sampling period.



**Figure 15:** Air quality monitoring at location AQ1 on 19rd March 2019

As per ToR additional survey for the parameter CH<sub>4</sub>, VOC, CO<sub>2</sub>, CO, H<sub>2</sub>S has been undertaken at selected locations (see Methodology).



**Figure 16:** Air quality monitoring at location AQ3 on 20th August 2019



Figure 17: View around AQ2 (Thilhafushi) on 25th August 2019

7.4.1 Air Quality baseline survey AQ 1 (Thilafushi workers camp)

Weather/climate	Clouds	Wind direction	Wind speed	Dumpsite
Sunny 33°C	No	North-East	Low-moderate	Open burning

Parameter	Date	$\mu\text{g}/\text{m}^3$	WHO ambient air quality guideline (as per Table 1.1.1 of IFC EHS guidelines) in $\mu\text{g}/\text{m}^3$
PM <sub>10</sub>	19.03.-20.03.2019	26,5 [24 hr]	50 [24 hr]
PM <sub>2,5</sub>	19.03.-20.03.2019	<b>26,9 [24 hr]</b>	25 [24 hr]
SO <sub>2</sub>	22.03.-23.03.2019	<b>214 [24 hr]</b>	20 [24 hr]
		<b>866 [10 min max]</b>	500 [10 min]

NO <sub>2</sub>	19.03.-20.03.2019	67,5 [1 hr max.]	200 [hr]
-----------------	-------------------	------------------	----------

Additional parameters according ToR

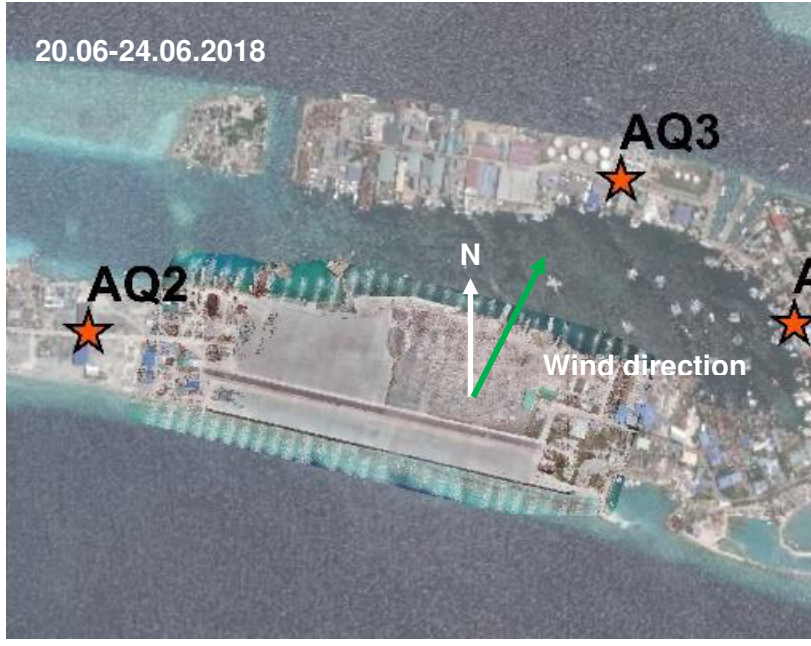

Parameter	Date	µg/m <sup>3</sup>	WHO ambient air quality guideline (as per Table 1.1.1 of IFC EHS guidelines) in µg/m <sup>3</sup>
CH <sub>4</sub>	19.03.-20.03.2019	11.745 [24 hr]	N/a
CO	19.03.-20.03.2019	126 [24 hr]	N/a
VOC	21.03.2019	4.889 [24 hr]	N/a

7.4.2 Air Quality baseline survey AQ 2 (Thilafushi 2, new reclaimed area)

Weather/climate	Clouds	Wind direction	Wind speed	Dumpsite
Sunny 32°C	yes	North-East	moderate	Open burning

Parameter	Date	µg/m <sup>3</sup>	WHO ambient air quality guideline (as per Table 1.1.1 of IFC EHS guidelines) in µg/m <sup>3</sup>
PM <sub>10</sub>	25.08.-26.08.2019	<b>538,93 [24 hr]</b>	50 [24 hr]
PM <sub>2,5</sub>	25.08.-26.08.2019	<b>387,45 [24 hr]</b>	25 [24 hr]
SO <sub>2</sub>	-	N/a	20 [24 hr]
		N/a	500 [10 min]
NO <sub>2</sub>	28.08.-29.08.2019	72,8 [1 hr max]	200 [hr]

7.4.3 Air Quality baseline survey AQ 3 (Thilafushi 3, Opposite of dumpsite)

Weather/climate	Clouds	Wind direction	Wind speed	Dumpsite
Sunny 31°C	yes	North-East	Moderate-high	Open burning
<p>20.06-24.06.2018</p> 				
Weather/climate	Clouds	Wind direction	Wind speed	Dumpsite
Sunny 33°C	yes	West	moderate	Open burning
<p>25.08-26.08.2019</p> 				

Parameter	Date	$\mu\text{g}/\text{m}^3$	WHO ambient air quality guideline (as per Table 1.1.1 of IFC EHS guidelines) in $\mu\text{g}/\text{m}^3$
PM <sub>10</sub>	20.06.-21.06.2018	<b>359,7 [24 hr]</b>	50 [24 hr]
	21.06-22.06.2018	<b>96,50 [24 hr]</b>	
	22.06-23.06.2018	<b>86,29 [24 hr]</b>	
	23.06-24.06.2018	<b>291,47 [24 hr]</b>	
	25.08.-26.08.2019	<b>88,46 [24 hr]</b>	
PM <sub>2,5</sub>	20.06.-21.06.2018	<b>233,33 [24 hr]</b>	25 [24 hr]
	21.06-22.06.2018	<b>61,38 [24 hr]</b>	
	22.06-23.06.2018	<b>51,38 [24 hr]</b>	
	23.06-24.06.2018	<b>184,70 [24 hr]</b>	
	25.08.-26.08.2019	<b>42,81 [24 hr]</b>	
SO <sub>2</sub>	22.06-24.06.2018	<b>291 24 [hr]</b>	20 [24 hr]
		<b>970 [10 min max]</b>	500 [10 min]
NO <sub>2</sub>	28.08.-29.08.2019	72,8 [1 hr max]	200 [hr]

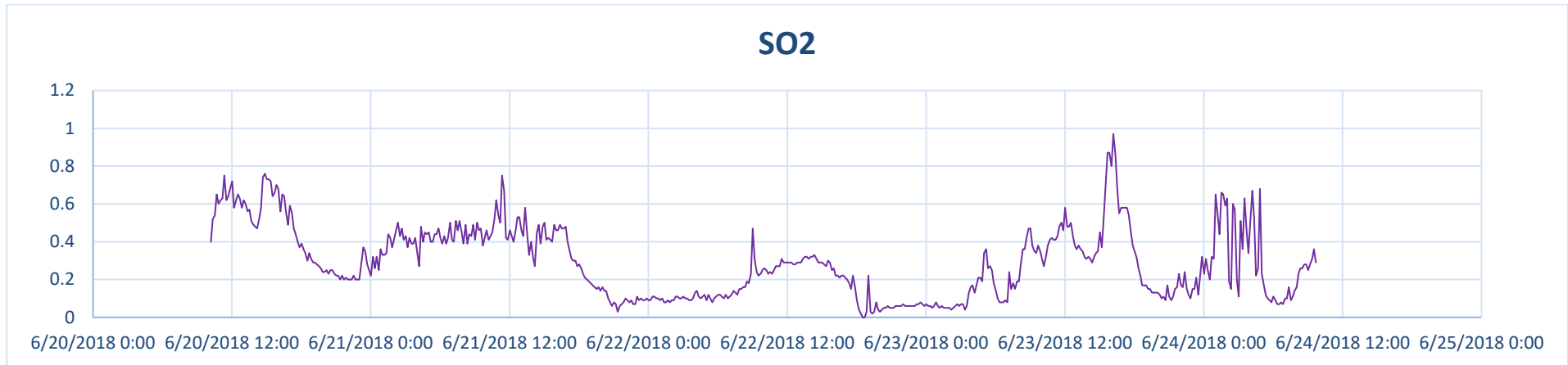


Figure 18: graphical presentation of survey results for SO<sub>2</sub> at AQ3 (PPT)

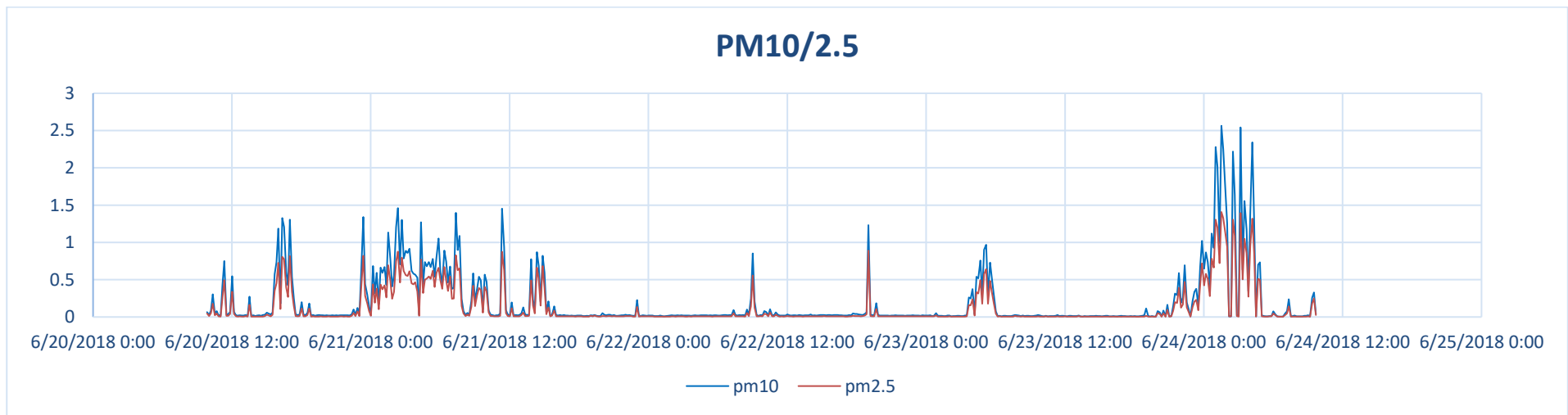


Figure 19: graphical presentation of survey results for PM<sub>2.5</sub> and PM<sub>10</sub> at AQ3 (PPT)



#### 7.4.4 Air Quality baseline survey AQ 4 (Vilingili)

Parameter	Date	$\mu\text{g}/\text{m}^3$	WHO ambient air quality guideline (as per Table 1.1.1 of IFC EHS guidelines) in $\mu\text{g}/\text{m}^3$
PM <sub>10</sub>	06.03.-08.03.2019	22,7 [24 hr]	50 [24 hr]
PM <sub>2,5</sub>	06.03.-08.03.2019	22,7 [24 hr]	25 [24 hr]
SO <sub>2</sub>	06.03.-08.03.2019	7,6 [24 hr]	20 [24 hr]
		190 [10 min max]	500 [10 min]
NO <sub>2</sub>	06.03.-08.03.2019	87 [1 hr]	200 [hr]

#### Additional parameters according ToR

Parameter	Date	$\mu\text{g}/\text{m}^3$	WHO ambient air quality guideline (as per Table 1.1.1 of IFC EHS guidelines) in $\mu\text{g}/\text{m}^3$
CH <sub>4</sub>	06.03.-08.03.2019	0,175 [24 hr]	N/a
CO	06.03.-08.03.2019	124 [24 hr]	N/a

#### 7.4.5 Interpretations of the results

The ambient air quality results obtained from the monitoring undertaken at Thilafushi indicate that only some parameters were within the WHO guidelines for ambient air quality.

As it could be seen one main influencing factor is the dumpsite at Thilafushi and its illegal burning

Particular matters usually varies between 27-540  $\mu\text{g}/\text{m}^3$  (daily average) with a min around 4  $\mu\text{g}/\text{m}^3$  and a maximum peak reaching more than 2.000  $\mu\text{g}/\text{m}^3$ .

NO<sub>2</sub> (hourly maximum) are below WHO guidelines at all places

SO<sub>2</sub> is in the range of 214-290  $\mu\text{g}/\text{m}^3$  (24 hr average) and 800-866  $\mu\text{g}/\text{m}^3$  and over the WHO values.

It must be noted that at each period of surveying the dumpsite was burning and that unfortunately the wind direction and the wind speed (velocity) were during the survey period exactly in the direction of the survey points. It can be seen that when the velocity is low (AQ 1 end of March 2019) or the wind direction is not in the direction of the survey point (AQ3 August 2019) the parameters are closer to the WHO guidelines.

For Vilingili as the main inhabited islands close to Thilafushi all the parameters are below the WHO guidelines.

## 8 Identification and assessment on potential effects

### 8.1 General emission

The following maximum mass concentrations should be achieved by the flue gas cleaning.

Table 7: Maximum mass concentration

Substance	Mass concentration [1]
Total dust, including particulate matter (No 5.2.1 TA Luft)	5 mg /m <sup>3</sup>
Fluorine and its compounds, indicated as hydrogen fluoride (5.2.4 Class II TA Luft)	1 mg /m <sup>3</sup>
gaseous inorganic chlorine compounds, indicated as hydrogen chloride (5.2.4 class III TA Luft)	10 mg/m <sup>3</sup>
Ammonia (5.2.4 class III TA Luft)	10 mg/m <sup>3</sup>
Sulphur oxides (sulphur dioxide and sulphur trioxide), expressed as sulphur dioxide (5.2.4 Class IV TA Luft)	50 mg/m <sup>3</sup>
Nitrogen oxides (nitrogen monoxide and nitrogen dioxide), expressed as nitrogen dioxide (5.2.4 (2), 2nd sentence TA Luft)	150 mg/m <sup>3</sup>
Carbon monoxide (5.2.4 para. 2 sentence 1 TA Luft)	50 mg/m <sup>3</sup>
organic substances (expressed as total C) (TA Luft 5.4.10.20)	10 mg/m <sup>3</sup>
Mercury and its compounds, reported as Hg (No 5.2.2 Class I TA Luft)	0.03 mg/m <sup>3</sup>
Dioxins and furans	0.1 ng/m <sup>3</sup>
Sum of heavy metals and their components: antimony, chromium, copper, manganese, vanadium, tin, lead, cobalt, nickel (5.2.2 TA Luft class II and III)	as total 0.5 mg/m <sup>3</sup>
Thallium and its compounds (5.2.2 TA Luft class I) cadmium	as total of 0.05 mg/m <sup>3</sup>
Arsenic/cadmium and its compounds (expressed as As and Cd), benzo (a) pyrene, water-soluble cobalt compounds (expressed as Co), chromium (VI) compounds (expressed as Cr) (5.2.7.1.1 TA Luft Class I )	as total 0.05 mg / m <sup>3</sup>

#### 8.1.1 Emission mass flow

Table 8: Emission mass flow (for R = 115 713 m<sup>3</sup>/h, T = 180 °C, Ø = 2.12 m)

Substance	Masses concentration	Mass flow Q in kg/h	Factor S	Q/S in kg/h **
Total dust, including particulate matter (No 5.2.1 TA Luft)	5 mg/m <sup>3</sup>	0.579	0.08	7.2
Fluorine and its compounds, indicated as hydrogen fluoride (5.2.4 Class II TA Luft)	1 mg/m <sup>3</sup>	0.116	0.0018	64.3

Substance	Masses concentration	Mass flow Q in kg/h	Factor S	Q/S in kg/h **
Gaseous inorganic chlorine compounds, indicated as hydrogen chloride (5.2.4 class III TA Luft)	10 mg/m <sup>3</sup>	1,157	0.1	11.6
Ammonia (5.2.4 class III TA Luft)	10 mg/m <sup>3</sup>	1,157	-	-
Sulphur oxides (sulphur dioxide and sulphur trioxide), expressed as sulphur dioxide (5.2.4 Class IV TA Luft)	50 mg/m <sup>3</sup>	5,786	0.14	41.3
Nitrogen oxides (nitrogen monoxide and nitrogen dioxide), expressed as nitrogen dioxide (5.2.4 (2), 2nd sentence TA Luft)	150 mg/m <sup>3</sup>	11,108 *	0.1	111.08 *
Carbon monoxide (5.2.4 para. 2 sentence 1 TA Luft)	50 mg/m <sup>3</sup>	5,786	7.5	0.77
Organic substances (expressed as total C) (TA Luft 5.4.10.20)	10 mg/m <sup>3</sup>	1,157	0.1	11.6
Mercury and its compounds, reported as Hg (No 5.2.2 Class I TA Luft)	0.03 mg/m <sup>3</sup>	0.00347	0.0013	26.7
Dioxins and furans	0.1 ng/m <sup>3</sup>	1.16 x 10 <sup>-8</sup>	-	-
Sum of heavy metals and their components: antimony, chromium, copper, manganese, vanadium, tin, lead, cobalt, nickel (5.2.2 TA Luft class II and III)	0.5 mg / m <sup>3</sup>	0.05786	0.05 0.1	1.157 0.579
Thallium and its compounds (5.2.2 TA Luft class I) cadmium	0.05 mg / m <sup>3</sup>	0.00579	0.005	1.16
Arsenic / cadmium and its compounds (expressed as As and Cd), benzo (a) pyrene, water-soluble cobalt compounds (expressed as Co), chromium (VI) compounds (expressed as Cr) (5.2.7.1.1 TA Luft Class I)	0.05 mg / m <sup>3</sup>	0.00579	0.00005	<b>115.7</b>

\* According to point 5.5.3 TA Luft, the emission of nitrogen monoxide is based on a conversion rate of 60% to nitrogen dioxide, and is based on a ratio of NO/NO<sub>2</sub> = 90%/10%, cf. Annex 1.1

### 8.1.2 Control of the necessity of the dispersion calculation

The determination of the ambient air quality characteristics is not required if the emissions of the air pollutants do not exceed the following minor mass flows:

Table 9: Minor mass flow according 4.6.1.1 TA Luft and WtE mass flow

Pollutants	Minor mass flow	Plant mass flow (Annex 2)
	in kg / h	
Emissions derived from stacks		
Dust (without consideration of dust contents)	1	0.579
Fluorine and its compounds, indicated as hydrogen fluoride (5.2.4 Class II TA Luft)	0.15	0.116
Gaseous inorganic chlorine compounds, indicated as hydrogen chloride (5.2.4 class III TA Luft)	-	1,157
Ammonia (5.2.4 class III TA Luft)	-	1,157
Sulphur oxides (sulphur dioxide and sulphur trioxide), expressed as sulphur dioxide (5.2.4 Class IV TA Luft)	20	5,786
Nitrogen oxides (nitrogen monoxide and nitrogen dioxide), expressed as nitrogen dioxide (5.2.4 (2), 2nd sentence TA Luft)	20	11.108
Carbon monoxide (5.2.4 para. 2 sentence 1 TA Luft)	-	5,786
Organic substances (expressed as total C) (TA Luft 5.4.10.20)	-	1,157
Mercury and its compounds, reported as Hg (No 5.2.2 Class I TA Luft)	0.0025	0.00347
Dioxins and furans	-	1,16x 10 <sup>-8</sup>
Sum of heavy metals and their components: antimony, chromium, copper, manganese, vanadium, tin, lead, cobalt, nickel (5.2.2 TA Luft class II and III)	0.025 lead, nickel (class II)	0.05786
Thallium and its compounds (5.2.2 TA Luft Class I)	0.0025	0.00579
Arsenic / cadmium and its compounds (expressed as As and Cd), benzo (a) pyrene, water-soluble cobalt compounds (expressed as Co), chromium (VI) compounds (expressed as Cr) (5.2.7.1.1 TA Luft Class I)	0.0025	0.00579

For most of substances the values are below the minor mass flows. For mercury as well as heavy metals and their components (referred to thallium and arsenic/cadmium and lead/nickel) the values are over the minor flows, therefore there is a need to perform the **dispersion modelling** for these substances.

For ammonia and hydrogen chloride (5.2.4 Class III TA Luft), for carbon monoxide, for organic substances (expressed as total C) as well as dioxins and furans no minor mass flow are set in the regulations therefore there is no need to undertake a detailed dispersion modelling for these parameters either.

#### Emergency Gen-set

For the emissions mass flow calculation of the air pollutants of the emergency Gen-set, data of the client have been made available [1].

The following pollutants have to be considered. The exhaust gas volume flow was given as  $V_n = 12\,470 \text{ mN}^3/\text{h}$  and the exhaust gas temperature to  $T=180^\circ \text{C}$ .

Table 10: Minor mass flow according to Section 4.6.1.1 TA Luft - system mass flow

Substance	Minor mass flow	Plant mass flow in kg/h
	in kg / h	
Dust (without consideration of dust contents)	1	0.9976
Nitrogen oxides (nitrogen monoxide and nitrogen dioxide), expressed as nitrogen dioxide (5.2.4 (2), 2nd sentence TA Luft)	20	3.99
Carbon monoxide (5.2.4 (2) sentence 1 TA Luft)	-	3,741
Formaldehyde - HCHO	-	0,748

The minor mass flows have also been not exceeded by the Gen-set emission values, so that no dispersion calculation has to be carried out for these substances.

For carbon monoxide and formaldehyde no minor mass flow has been set in the regulation. For these substances, so that for this substance group also no dispersion calculation is to be carried out.

No indications were found which requires a special case test according to section 4.8 TA Luft.

## 8.2 Air dispersion modelling for relevant parameter

In order to estimate exposures to airborne pollutants from the incineration and emergency electricity generation, dispersion modelling was carried out. Modelling was done for the pollutants: dust, nitrogen monoxide and nitrogen dioxide), carbon monoxide and formaldehyde from the emergency electricity generation sets. Modelling was done for the pollutants: total dust including fine dust, fluoride and its compound specified as hydrogen fluoride, ammonia, sulphur (sulphur dioxide and sulphur trioxide), specified as sulphur dioxide, nitrogen oxide (nitrogen monoxide and nitrogen dioxide) specified as nitrogen dioxide and mercury and its compound specified as mercury from the waste to energy plant. The study zone was defined as a 5000 m radius of influence from incinerator stack at Thilafushi. The figure below shows the area around the proposed waste to energy plant at Thilafushi Island.

The dispersion modelling for the pollutants was carried out using the dispersion model AUSTAL2000. The computer program AUSTAL2000 is a reference implementation developed on behalf of the German Federal Environmental Agency

The program system AUSTAL2000 calculates the spread of pollutants and odours in the atmosphere. It is an extended implementation of Annex 3 of the German regulation TA Luft (Technical Instruction on Air Quality Control) demands for dispersion calculations a Lagrangian particle model in compliance with the German guideline VDI 3945 Part 3. The modelling work was carried out by Ulbricht Consulting (Germany). The dispersion modelling report is attached as an Annex 1 to this report.

Steady-state Gaussian plume models assess pollutant concentrations and/or deposition fluxes from a variety of sources associated with an industrial source complex. Unlike the Gaussian models commonly used, this flexible modelling procedure used in AUSTAL2000 provides realistic results even when buildings and uneven terrain influence flue gas dispersion. The model calculates the contribution of specified air pollutants from a given point source to the background concentrations present in the ambient air at ground level in the area surrounding the source.

Parameter for additional load, the parameter for the emission year-additional load (IJZ) is the average of all calculated individual contributions at each reference point.

#### 8.2.1.1 *Emission from installations*

The following emission sources have been considered:

Exhaust stack: WtE

The following operation time has been considered: 8,000 h/a

#### 8.2.1.2 *Emissions from guided sources*

For the emissions of the air pollutants of the incinerator WtE data are available from the client [1]. For the incineration plant, the following pollutants have been taken into account in the dispersion calculation. The exhaust gas volume flow was given as  $V_n = 115713 \text{ m}^3/\text{h}$  and the exhaust gas temperature as  $T = 180^\circ \text{ C}$ .

The air dispersion calculation was made with a stack height of 46,0 m.

In chapter 6 (Employer's requirement) of the DBO a minimum height of 50,0 m has been fixed.


Therefore the calculated emissions are presenting the worst case. With the extension of the stack, the ambient air concentration value will be reduced at the reception point.

Table 11: Emissions Stack WtE

Substance	mg / m <sup>3</sup>	Total V <sub>N</sub> m <sup>3</sup> /h	flow	Emission mass flow in kg/h
Total dust, including particulate matter	5	115713		0.579
Fluorine and its compounds, indicated as hydrogen fluoride	1			0.1 16
Ammonia	10			1,157
Sulphur oxides (sulphur dioxide and sulphur trioxide), expressed as sulphur dioxide	50			5,786
Nitrogen oxides (nitric oxide and nitrogen dioxide), expressed as nitrogen dioxide	150			11.108
Mercury and its compounds, indicated as Hg	0.03			0.0035
Sum of heavy metals and their components: antimony, chromium, copper, manganese, vanadium, tin, lead, cobalt, nickel (5.2.2 TA Luft class II and III)	0.5 mg / m <sup>3</sup>			0.05786
Thallium and its compounds (5.2.2 TA Luft class I)	0.05 mg / m <sup>3</sup>			0.00579
Arsenic / cadmium and its compounds (expressed as As and Cd), benzo (a) pyrene, water-soluble cobalt compounds (expressed as Co), chromium (VI) compounds (expressed as Cr) (5.2.7.1.1 TA Luft Class I)	0.05 mg / m <sup>3</sup>			0.00579

CONSULTING - WtE Thilafushi



3.1 Auszug aus der fischen Karte	Firmenname: Ingenieurbüro Ulbricht GmbH		
	Bearbeiter: Dipl. Ing. (FH) Uta Figula		
	QUELLEN: 1	MASSSTAB: 1:23.000 0 0,5 km	
	DATUM: 22.05.2019		

iv - Lösser Environmental Software & Argusoft

© 401.0537/Kodak/FKode

Figure 20: Location of the emission points where maximum load was calculated and examined

Computer model

For the calculation the dispersion model AUSTAL2000, version 2.6.11-WI-x, of the company Janicke Consulting was used, which is implemented in the program AustalView TG of the company Argusoft. The program system AUSTAL2000 calculates the spread of pollutants and odours in the atmosphere. It is an extended implementation of Annex 3 of the TA Luft. The model underlying the program is described in guideline VDI 3945 Part 3.



### Computational domain

Due to the stack height of 46 m the calculation area has a radius of at least 2300 m (50 times the height). The grid for the calculation of concentration and deposition shall be selected in accordance with Chapter 7 (2) of Annex 3 of the TA Luft so that the location and contribution of the maximum ambient air quality can be determined with sufficient certainty. This is usually the case when the horizontal mesh size does not exceed the stack height. At source distances greater than 10 times the height of the stack, the horizontal mesh size can be selected proportionally larger. The calculations and assessments were carried out in an area of 3.2 x 2.6 km and a grid with mesh sizes of 5 to 20 m.

### Ground roughness

The ground roughness of the terrain is described by an average roughness length  $z_0$ . It is in accordance with the land use classes in the CORINE cadastre. The roughness length was chosen to be  $z_0 = 0,2$  in the calculation. This value should be considered representative for the area of calculation

### Sources

In the calculation program emission source can be differentiated into different source types. Exhaust stacks are defined as point sources.

The source calculated on the basis of the emission behaviour described in Appendix 3, in accordance with Appendix 3, was entered using the parameters described. The parameters and emission data are given in Appendix 3. An emission source plan is also included in Appendix 3.

### Pollutants

As per Table 4 in section 6 the dispersion modelling is required for mercury and heavy metals and their components (represented by lead/nickel, thallium and arsenic/cadmium). For all other pollutants, the minor mass flows according to Table 7 of No. 4.6.1.1 of the TA Luft have not been exceeded. For these substances, it can be assumed that harmful environmental effects from the plant cannot be caused.

The following pollutants relevant to the plant could be calculated according to TA Luft: dusts (dust precipitation, PM10), sulphur dioxide, nitrogen oxide, ammonia, mercury, arsenic, cadmium, nickel, lead, thallium. In the present case, for all relevant pollutants, insofar as emission limits are defined for these substances in TA Luft, the air dispersion modelling has been run.

For the other relevant pollutants: total C, carbon monoxide (CO), hydrogen chloride, dioxins and furans, no emission values are specified in the TA Luft.

### Dispersion class time series

The wind direction and wind speeds were modelled with a dispersion class time series for the year 2017 [8].

### Terrain and slope

It is a flat terrain. In the computing area, no gradients of more than 1:20 or more than 1:5 occur.

### Statistics

The resulting statistical uncertainty (in %) was taken into account in the evaluation. The calculation was performed with the quality level "2". To assess the ambient air quality limits, the calculated value have been increased by the statistical uncertainty.

### Receiver points

In the examination area two ambient air quality points have been determined for the calculations. The BUP 1 was chosen as the point of presumed highest load due to the shortest distance to the emission source. The ANP 1 (nearby a food place), due to which in comparison with the BUP 1 gives the higher additional load of pollutant deposition, was to be considered in more detail. The location of the ambient air quality points can be found in Annex 3.

**Table 12: Ambient air quality points**

Ambient air quality points
BU P 1 West
ANP 1 east

### 8.3 Maximum ground level/Additional load

The following results apply exclusively taking into account the characteristics of the emission sources mentioned in Chapter 7. The dispersion calculation is required for the substances mentioned in chapter 6.1. All other results in Table 10 are presented for information only. As a guide, a comparison is made with the irrelevance values and the ambient air quality values of TA Luft.

The detailed analysis results are given in Appendix 3 and the grid diagram representation of the substances (except for ammonia and suspended particulate PM<sub>10</sub>) could be found in Annex 4 .

**Table 13: Ambient air quality Maximum ground level/additional load (IZ) (including statistical uncertainty)**

Ambient air quality points	Irrel. IZ	IW	BUP 1	ANP 1
Substance				
Mercury g/(m <sup>2</sup> d)	0.05	1	0,007	1.0
PM <sub>DEP</sub> g/(m <sup>2</sup> d)	0.0105	0.35	0,0001	0,0001
PM10 µg/m <sup>3</sup>	1.2	40	0	0
Hydrofluoric µg/m <sup>3</sup>	0.04	0.4	0	0.005
Sulphur dioxide µg/m <sup>3</sup>	1.5	50	0	0.2
Nitrogen oxides µg/m <sup>3</sup>	1.2	40	0	0.4
Ammonia µg/m <sup>3</sup>	-		0	0.04
Lead µg/(m <sup>2</sup> d)	5	100	0,2	17,0
Nickel µg/(m <sup>2</sup> d)	0.75	15	0,122	17,1
Thallium µg/(m <sup>2</sup> d)	0.1	2	0,01	1,7
Cadmium µg /(m <sup>2</sup> d)	0.1	2	0.01	1, 7
Arsenic µg/(m <sup>2</sup> d)	0.2	4	0.02	1,7

A pre-pollution with air pollutants at the site is not known (baseline), so it is assumed that the calculated values represent the total load.

### *Evaluation point BUP 1*

At assessment point BUP 1, the values are below the “irrelevance thresholds” of TA Luft for the substances.

### *Analysis point ANP 1*

At the ANP 1 analysis point, the air pollutants PM10, dust precipitation, sulphur dioxide, nitrogen oxides, hydrogen fluoride fall below the irrelevance values according to TA Luft.

If an orienting comparison is made with the air quality values of TA Luft, the following can be stated:

- For lead, thallium, cadmium, arsenic, the ambient air quality value of TA Luft is below. For mercury, the ambient air quality value of TA Luft is reached (not exceeded).
- The specified ambient air quality value in the TA Luft for nickel is exceeded. In the calculation, the heavy metal nickel was considered representative of the group of heavy metals and their components: antimony, chromium, copper, manganese, vanadium, tin, lead, cobalt, nickel (5.2.2 TA Luft class II and III).

Taking into account the volumetric flow and the desired mass concentration (corresponding to the emission limit value (class II according to 5.2.2 TA Luft) for the group of heavy metals, the emission mass flow for the group of heavy metals was assigned to the substance nickel. From a technical perspective it is not expected that none of the further elements of the heavy metal group occur in the exhaust gas, so that the exceeding of the ambient air quality value for nickel is likewise not expected.

### Ammonia

No ambient air quality value is specified for ammonia. The desired mass concentrations by means of flue gas cleaning are below the values specified in the TA Luft (limit values). A negative impact on the environment is therefore not expected.

### Hydrogen chloride, total C, carbon monoxide (CO), dioxins and furans

No ambient air quality values are specified for these substances. The mass concentrations aimed at by means of flue gas cleaning are below the values stated in the TA Luft (limit values). A negative impact is therefore not to be feared.

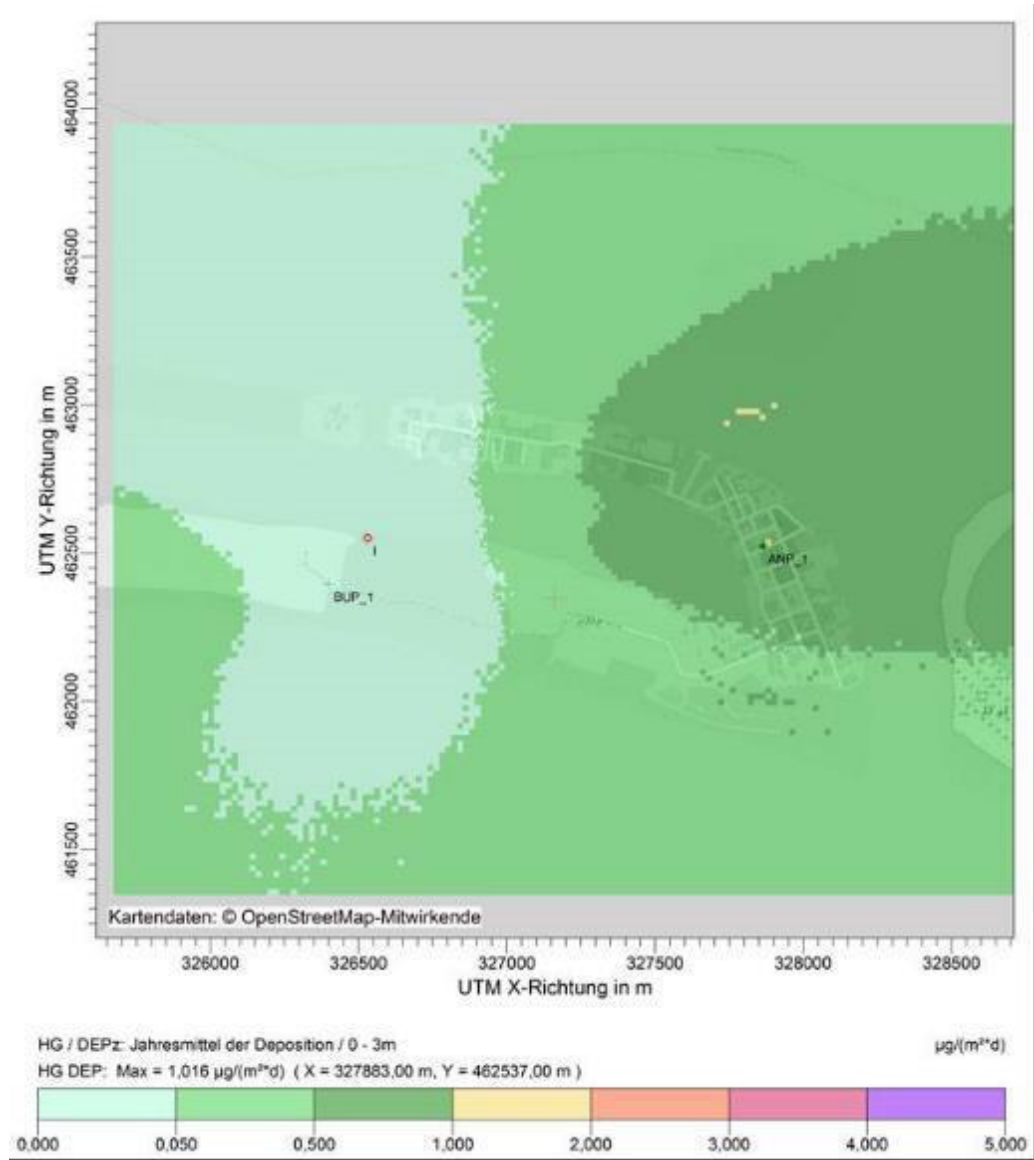


Figure 21: additional load Mercury-Deposit from the dispersion model.

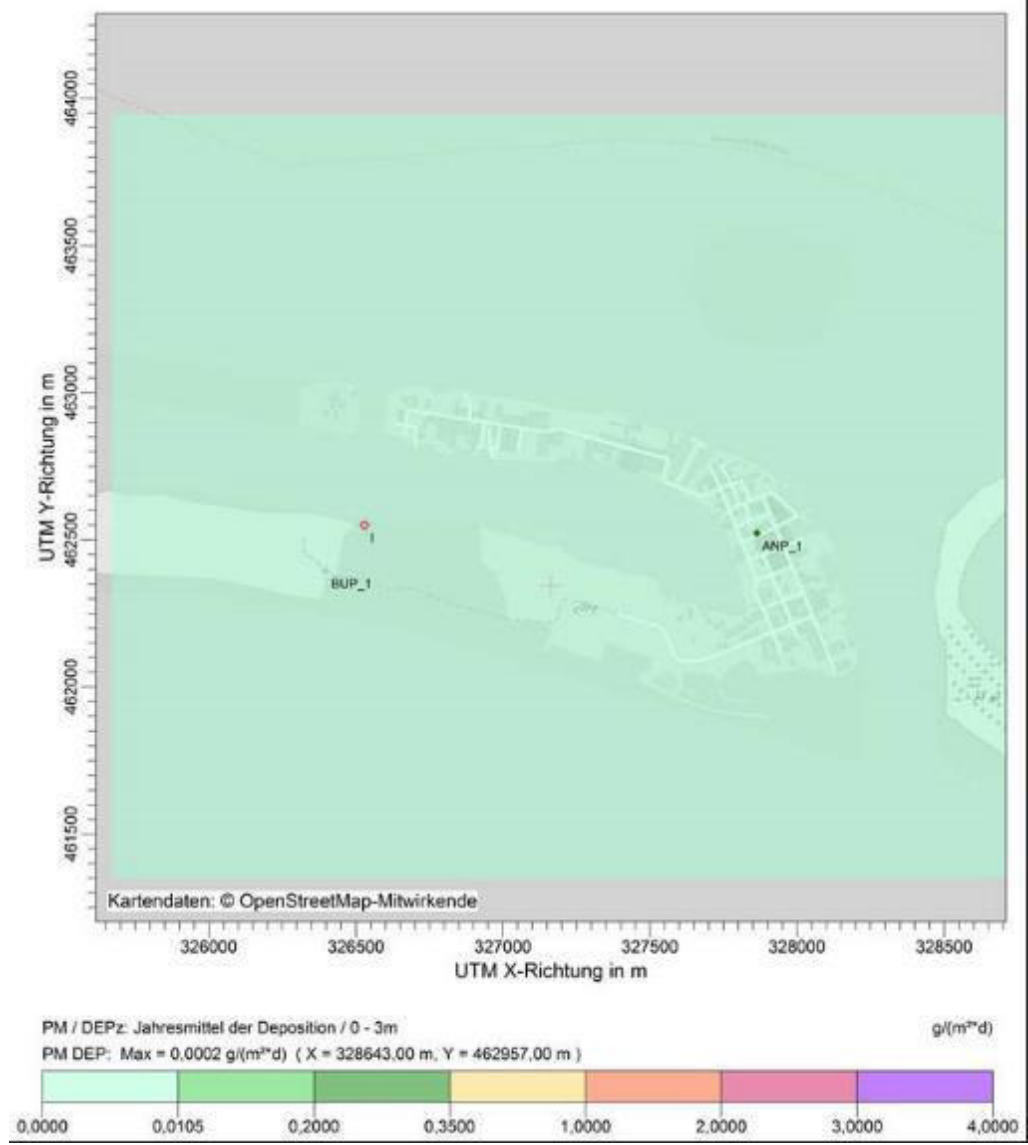


Figure 22: PM-Deposit from the dispersion model.

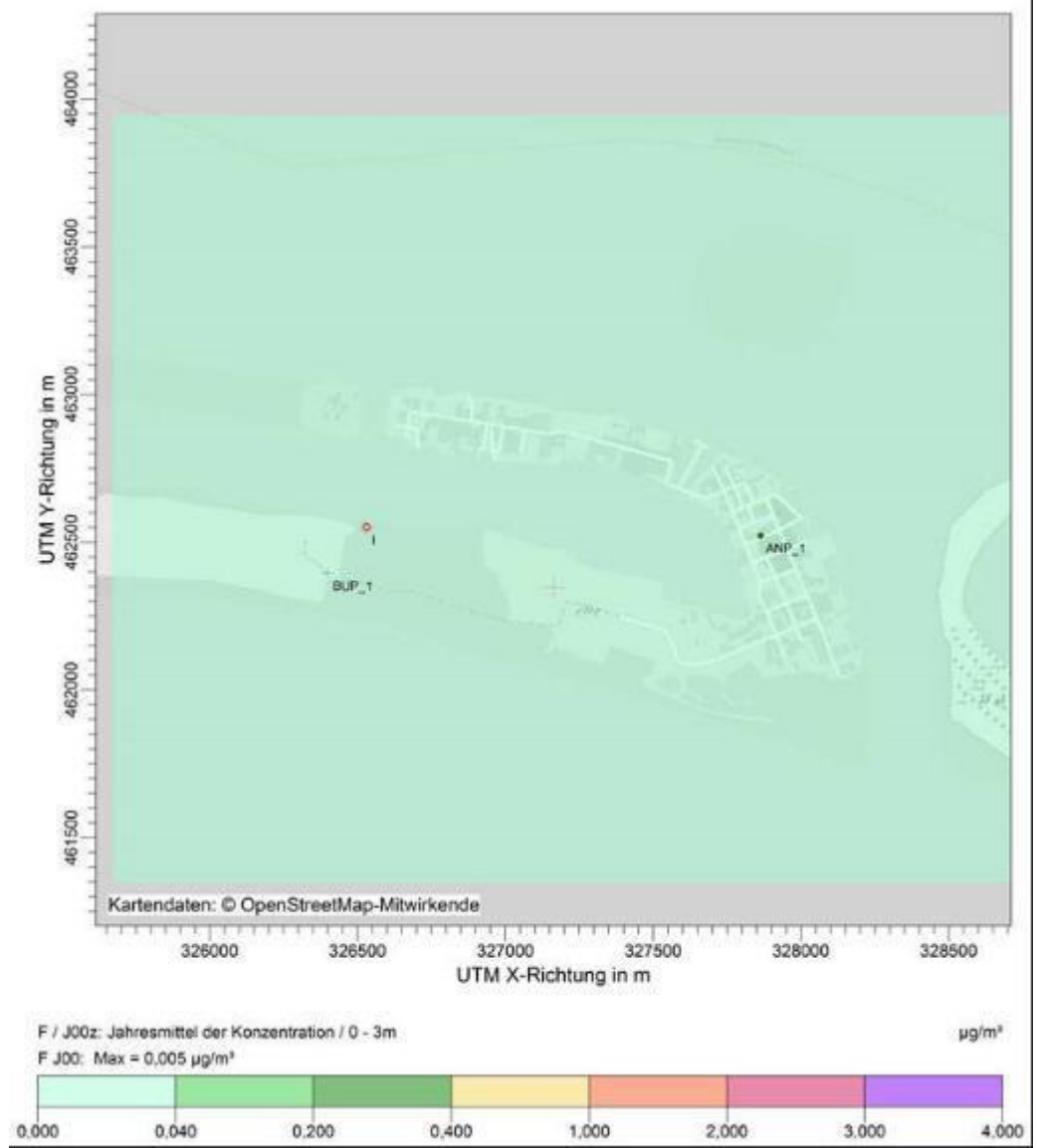


Figure 23: F-Deposit from the dispersion model.

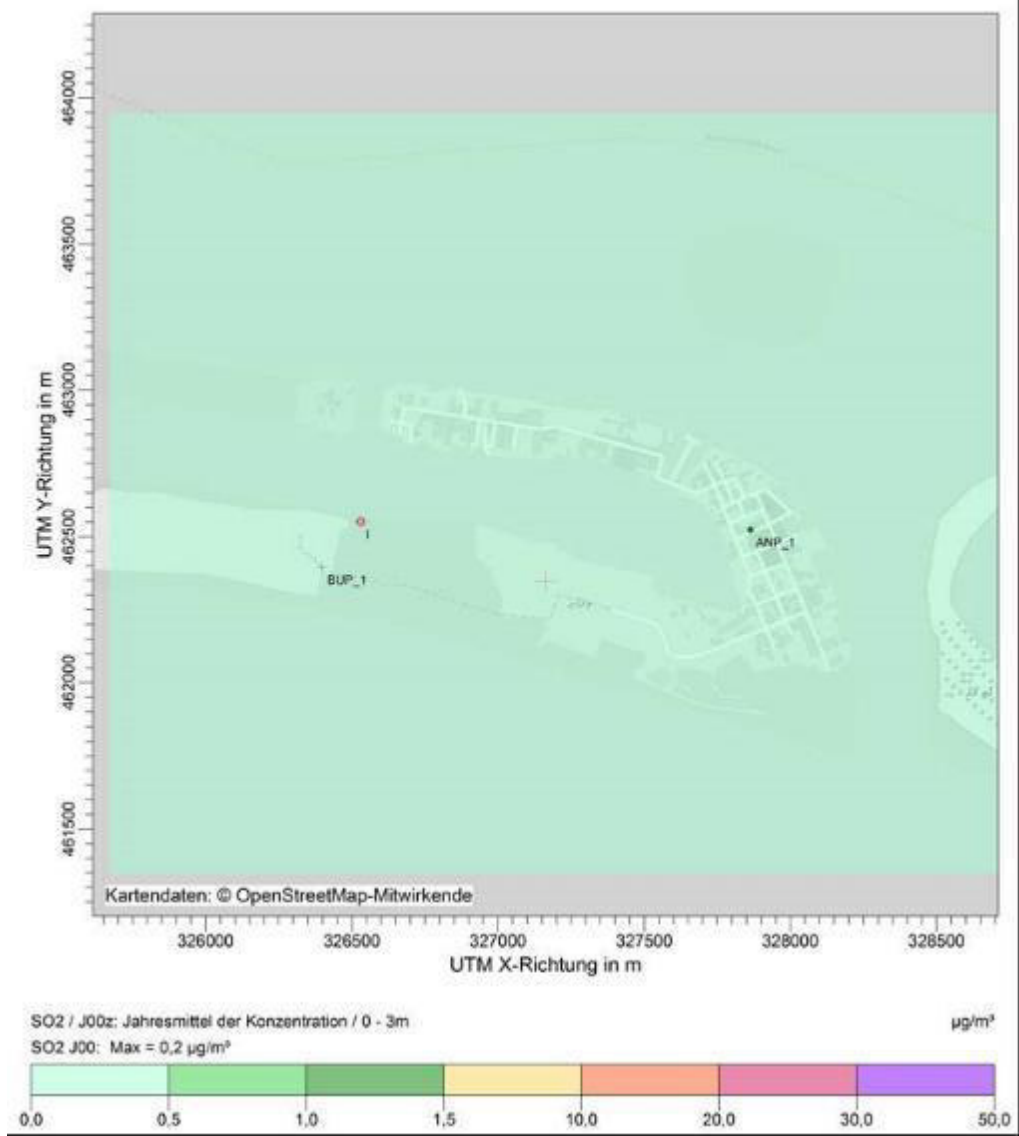


Figure 24: SO<sub>2</sub>-Deposit from the dispersion model.

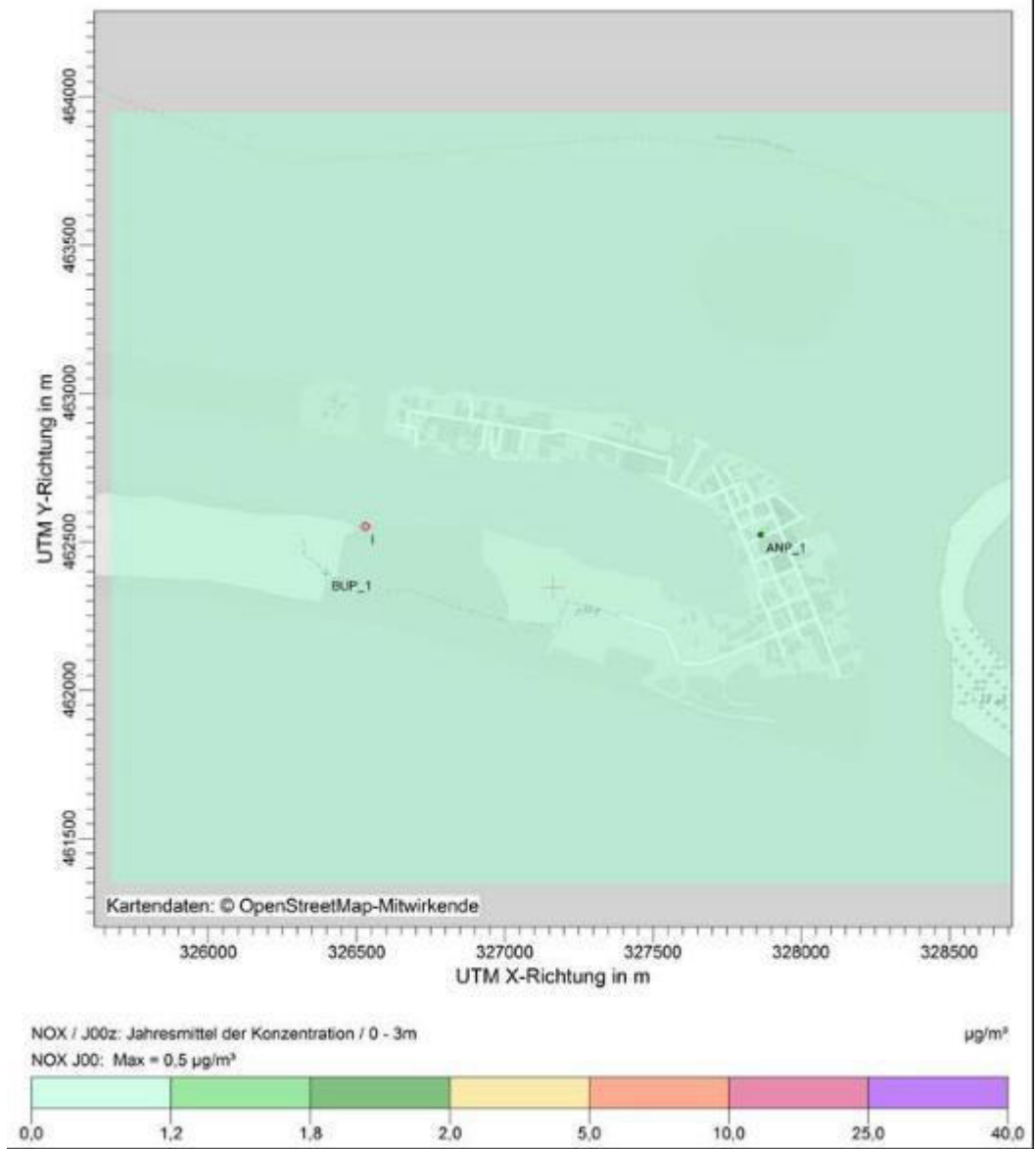


Figure 25: NOx-Deposit from the dispersion model.



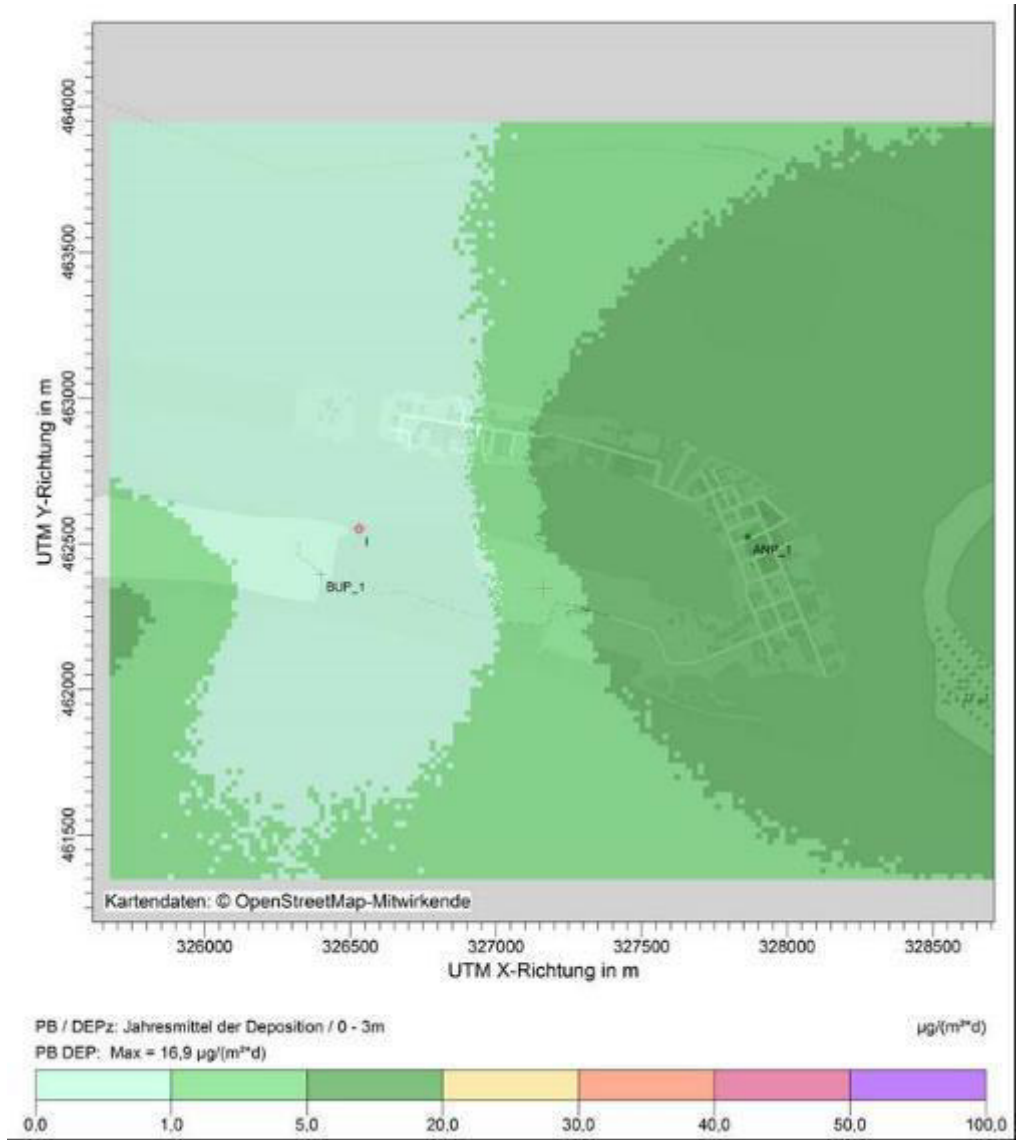


Figure 26: Pb-Deposit from the dispersion model.

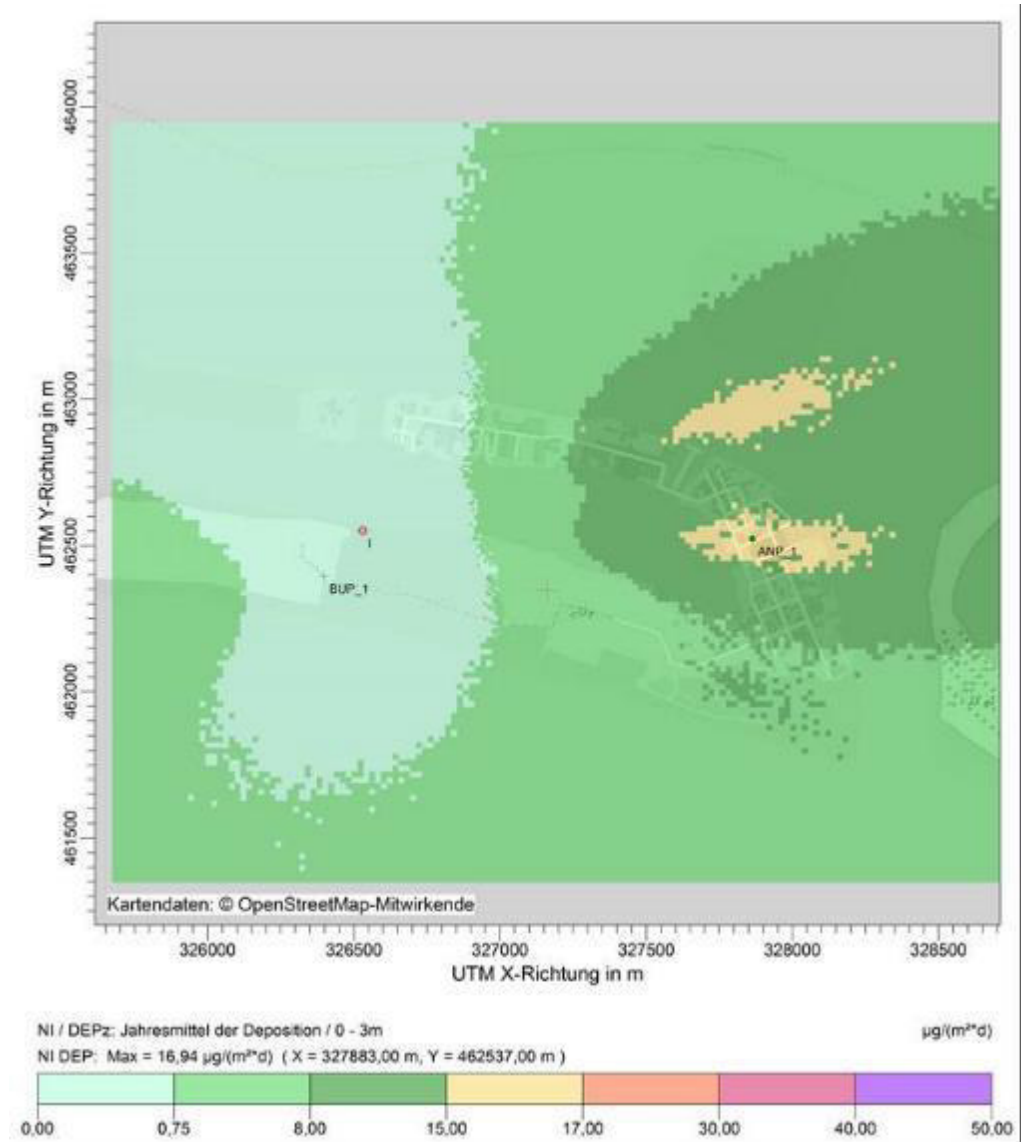


Figure 27: Ni-Deposit from the dispersion model.

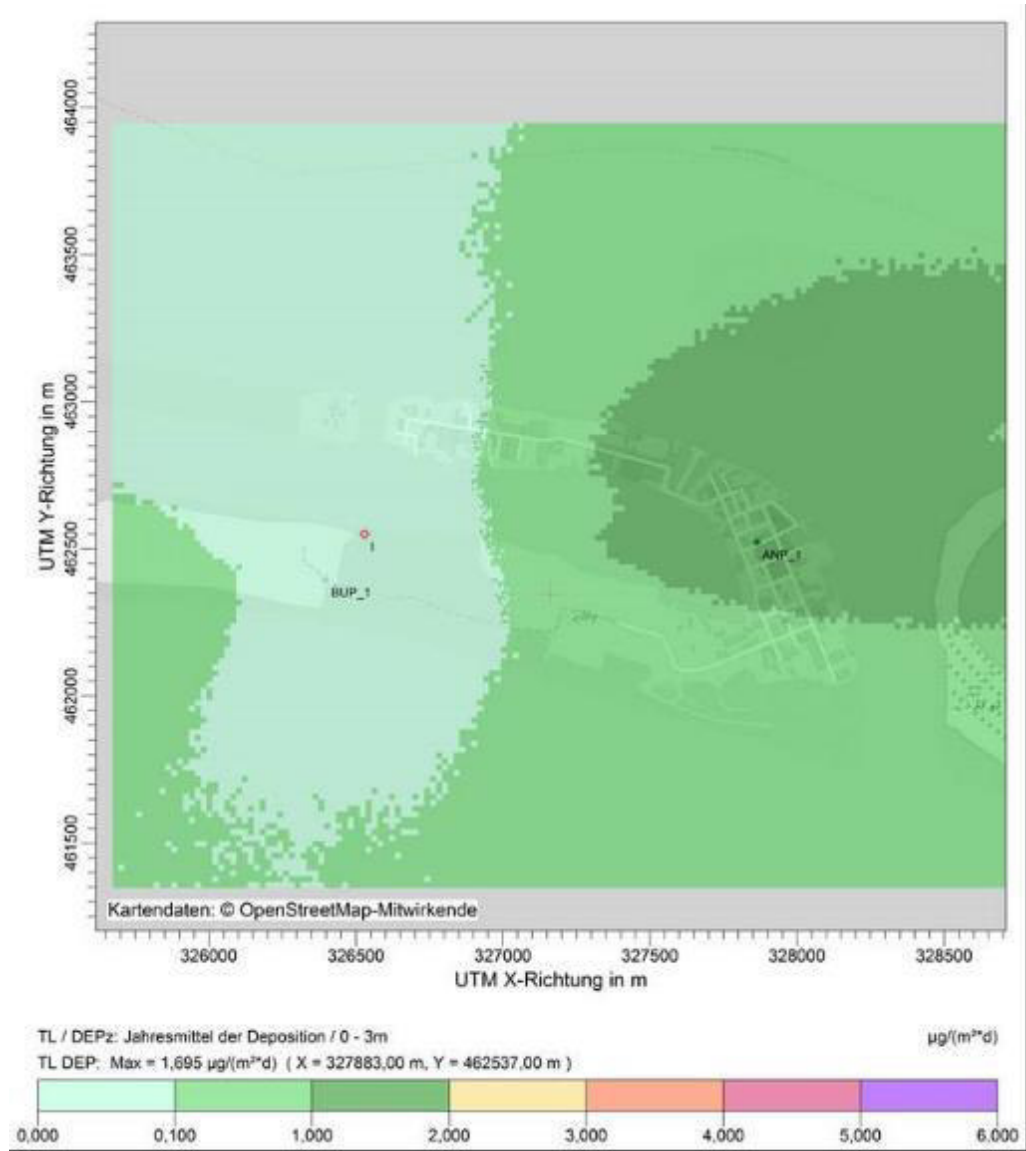


Figure 28: TI-Deposit from the dispersion model.

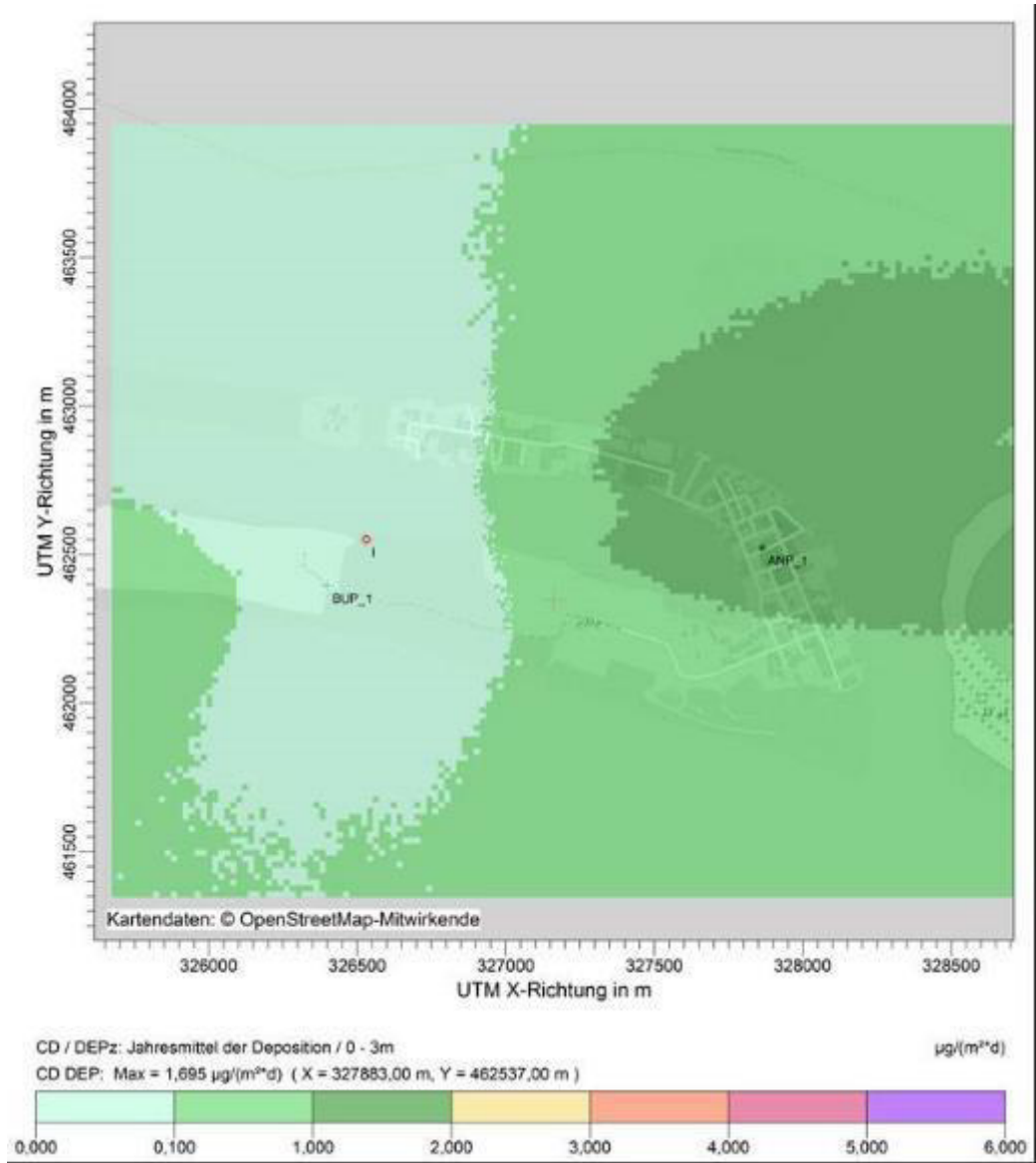


Figure 29: Cd-Deposit from the dispersion model.

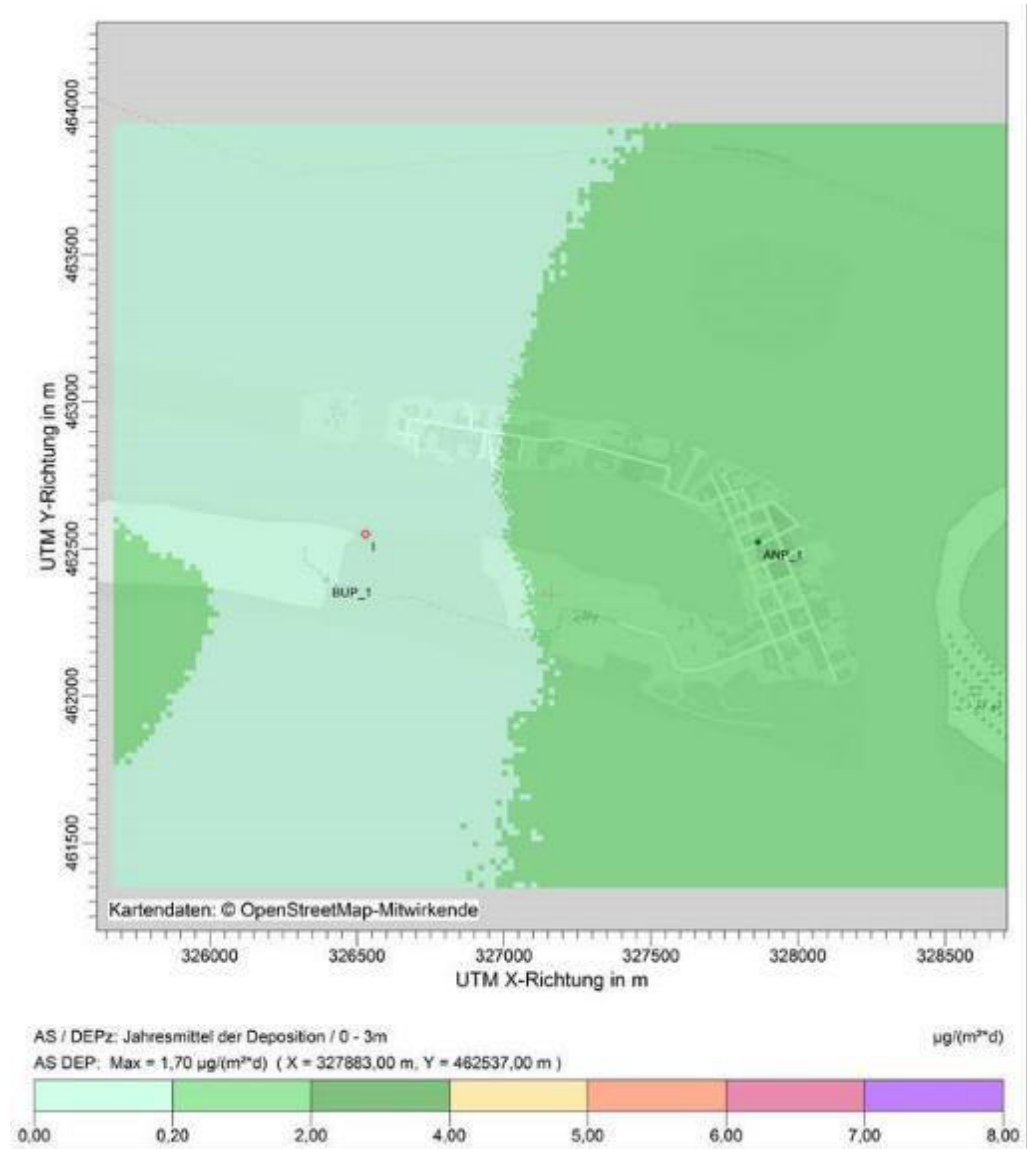


Figure 30: As-Deposit from the dispersion model.

The overall air quality of the project site is expected to increase with time. More significantly when the existing dumpsite is closed. Therefore, a long term, positive, and significant impact is expected with the operation of this project.

#### 8.4 Interpretation of the results with respect to baseline conditions

Considering only the additional from process contribution it is clear that no harmful pollution is to be expected from the installation. Actually the baseline situation is mainly characterized by the dumpsite of Thilafushi which is set to be closed at the start of the operation of the new facility. Therefore the following results needs to be considered with care

Substance	Averaging time	AQ Standard/ Guideline ( $\mu\text{g}/\text{m}^3$ )	Baseline ( $\mu\text{g}/\text{m}^3$ )	Process contribution ( $\mu\text{g}/\text{m}^3$ )	PC/ AQSG	Combined process + baseline ( $\mu\text{g}/\text{m}^3$ )	Combined/ AQSG
Particulate matter (PM <sub>10</sub> )	24 hr average	50	<b>538,94</b>	0,100	0,20%	539,04	<b>1078,08%</b>
Particulate matter (PM <sub>10</sub> )	1 year	20		0,000	0,00%		
Particulate matter (PM <sub>2,5</sub> )	24 hr average	25	<b>387,57</b>	0,100	0,40%	387,67	<b>1550,68%</b>
Particulate matter (PM <sub>2,5</sub> )	1 year	10		0,000	0,00%		
Sulfur dioxide SO <sub>2</sub>	24 hr average	20	<b>291,24</b>	0,200	1,00%		
Sulfur dioxide SO <sub>2</sub>	10 minutes	500	<b>970,00</b>	1,333	0,27%	971,33	<b>194,27%</b>
Nitrogen dioxide (NO <sub>2</sub> )	1 year	40		0,000	0,00%		
Nitrogen dioxide (NO <sub>2</sub> )	1 hr	200	72,80	0,017	0,01%	72,82	36,41%

## 9 Conclusions

The ambient air quality status of Maldives had been unknown due to the lack of air quality monitoring data. The air quality is generally considered good as the sea breezes flush the air masses over the small the islands. However rapid urbanization and economic growth in the recent years has shown noticeable changes in the air quality, particularly in the Male' region. Thilafushi Island is being used to dump huge volume of wastes from the neighbouring inhabited islands (Malé, Villingili and Hulhumalé) and nearby resort islands. Open burning of mixed wastes is being practiced at the island to reduce the volume of the waste. The smoke generated from burning increases the air pollutant load in the local air shed and also affects the air quality of the island.

The air quality at the Thilafushi Island is expected to be polluted i.e. the values for the pollutants such as  $PM_{2.5}$ ,  $PM_{10}$ ,  $SO_2$  and  $NO_x$  are expected to be higher in the region downwind of Thilafushi as the smoke plume generated from the open burning of waste frequently passes through this region. The numbers of stations and their locations for baseline air quality monitoring was selected to collect ambient air quality data that is representative of the baseline air quality of the Thilafushi Island and its surrounding areas.

Air quality monitoring for baseline was conducted at four locations. One station was selected in the downwind direction of the WtE stack emission plume while another station was placed at the cross wind direction of the plume. One station was selected in the cross wind direction of the smoke plume from the existing dump site at Thilafushi. Additional station was selected at Vilingili as a control site.

The ambient air quality results obtained from the monitoring at Villingili undertaken indicate that all parameters were within the WHO guidelines for ambient air quality at station AQ-4 (Villingili Island). The stations at AQ-1 AQ-2 and AQ-3 had all parameters that were beyond the WHO guidelines for ambient air quality. The monitoring results showed that the air quality of Thilfushi which are on downwind wind direction of the existing waste dump site is degraded with the smoke from the dumpsite.

In order to estimate exposures to airborne pollutants from the incineration and emergency electricity generation, air pollutant dispersion modelling was carried out. Modelling was done for the pollutants: total dust including fine dust, fluoride and its compound specified as hydrogen fluoride, ammonia, sulphur (sulphur dioxide and sulphur trioxide), specified as sulphur dioxide, nitrogen oxide (nitrogen monoxide and nitrogen dioxide) specified as nitrogen dioxide and mercury and its compound specified as mercury from the waste to energy plant.

The dispersion modelling for the pollutants was carried out using the dispersion model AUSTAL2000. The computer program AUSTAL2000 is a reference implementation developed on behalf of the German Federal Environmental Agency. AUSTAL2000 is a steady-state dispersion model that is designed for long-term sources and continuous buoyant plumes. Given that poor meteorological data coverage near the proposed project site, the dispersion model AUSTAL2000 was preferred to a popular dispersion model AERMOD, which requires high quality meteorological data to run the AERMOD.

The proposed site for the establishment of the WtE was reclaimed in 2018. The entire Island and the project location are mainly on the main level over MSL and do not present any substantial elevation.

The stack emission dispersion modelling showed, except for mercury as well as heavy metals and their components (referred to thallium and arsenic/cadmium and lead/nickel), maximum mass concentrations was achieved by the flue gas cleaning and will be mass concentration of the emission from the stack. Hence emission characteristics was not required as the emissions of the air pollutants do not exceed the minor mass flows. For mercury as well as other heavy metals and their components the values were over the minor flows, therefore dispersion modelling was carried out for these substances.

Dispersion modelling showed that the level of lead, thallium, cadmium, arsenic, would be below the ambient air quality value and for mercury, level in the the ambient air quality would be reached but not exceeded. It is not expected that heavy metal group occur in the exhaust gas, so that the exceeding of the ambient air quality value for nickel is not expected. The desired mass concentrations by means of flue gas cleaning are below the limit values for ammonia and a negative impact on the environment is therefore not expected. Similar is with hydrogen chloride, total carbon, carbon monoxide, dioxins and furans as desired mass concentrations by means of flue gas cleaning would achieve below the emission value limits.

Based on the predicted concentrations and the post project concentrations of concerned pollutants, it can be inferred that the ambient air quality of the area is unlikely to be affected significantly due to proposed project. The overall air quality of the project site is expected to increase with time. More significantly when the existing dumpsite is closed. Therefore, a long term, positive, and significant impact is expected with the operation of this project.



## References

German Engineer Association (2000) Guideline 3945 part 3 “Environmental meteorology/Atmospheric dispersion models –Particle model”

German Federal Environmental Agency (2000) AUSTAL2000

German Federal Environmental Agency (2002) First General Administrative Regulation Pertaining the Federal Immission Control Act (Technical Instructions on Air Quality Control – TA Luft)

MEE (2018). Feasibility Study for an Integrated Solid Waste Management System for Zone 3 (including Greater Malé) and Design of the Regional Waste Management Facility at Thilafushi, Ministry of Environment and Energy and Energy.

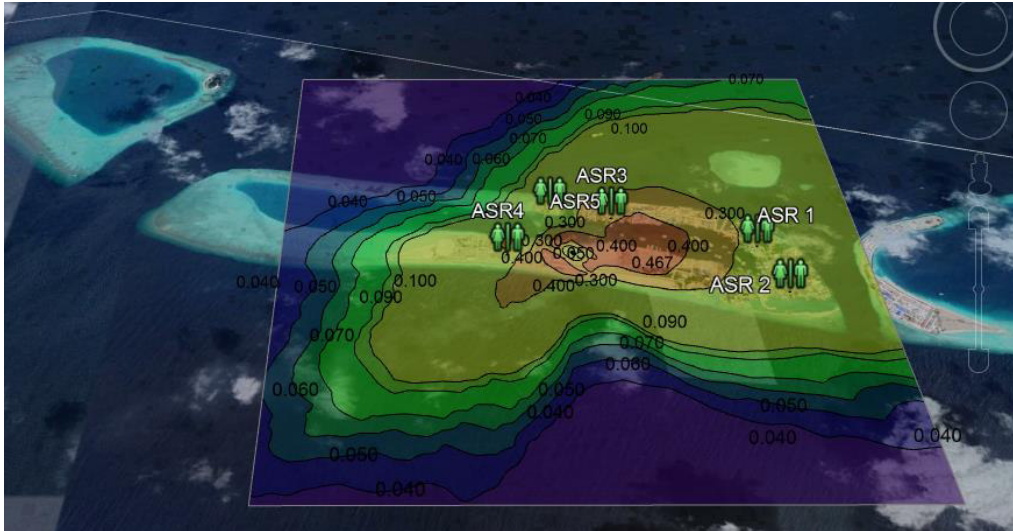
MEE (2017) EIA for the Proposed Reclamation of Thilafalhu for the establishment of the Regional Waste Management Facility for Zone 3, Kaafu Atoll, Ministry of Environment and Energy and Energy, Malé.

Ulbricht GmbH (2019) Revision and addition of the Stack height calculation and the determination of the emission of air pollutants for a waste incineration plant on Thilafushi / Maldives.

WHO (2005) Ambient Air Quality Guidelines

## DISPERSION MODEL REPORT AERMOD VALIDATION PROJECT

2 UNITS X 250 TON/DAY WTE GRATE TYPE INCINERATOR AND  
0.8 MW DIESEL GENERATORSET ENGINE



Greater Male' Waste to Energy Project  
Environmental Impact Assessment Waste to Energy

Draft as of 11 OCTOBER 2019

## TABLE OF CONTENTS

<b>EXECUTIVE SUMMARY</b> .....	<b>5</b>
<b>1. BACKGROUND INFORMATION</b> .....	<b>13</b>
<b>OBJECTIVES OF THIS STUDY</b> .....	<b>13</b>
<b>COMPONENT OF THE WTE PLANT</b> .....	<b>13</b>
<b>2. THE STUDY AREA</b> .....	<b>14</b>
<b>3. AIR POLLUTANTS OF CONCERN</b> .....	<b>14</b>
PARTICULATE MATTER EMISSIONS (PM) .....	14
CARBON MONOXIDE EMISSIONS (CO) .....	15
NITROGEN OXIDES EMISSIONS (NOX).....	15
SULFUR OXIDES EMISSIONS (SOX) .....	16
METALS EMISSIONS AND ACID GASES.....	16
GREENHOUSE GASES .....	16
<b>THE AIR DISPERSION MODEL</b> .....	<b>17</b>
<b>METEOROLOGY IN THE STUDY AREA - WIND ROSE</b> .....	<b>19</b>
GEP STACK HEIGHT = $H + 1.5L$ .....	32
DISTANCE FROM STACK-BLDG $\leq 5L$ .....	32
8.4 INPUT DATA IN THE DISPERSION MODEL (SOURCE PATHWAY) .....	36
9. RESULTS OF DISPERSION MODEL RUN.....	37
<b>10. DISCUSSION OF RESULTS</b> .....	<b>74</b>
<b>10.1 AERMOD VER.9.1 MODEL RUN USING TIER 3 MET DATA (MALDIVES</b> <b>METEOROLOGY)</b> .....	<b>74</b>
<b>10.2 TOTAL DUST (TD)</b> .....	<b>75</b>
<b>10.3 PARTICULATE MATTER 10 (PM-10)</b> .....	<b>75</b>
<b>10.4 SULFUR DIOXIDE (SO2)</b> .....	<b>75</b>
<b>10.5 NITROGEN OXIDES (NOX)</b> .....	<b>76</b>
<b>10.6 MERCURY (HG)</b> .....	<b>76</b>
<b>10.7 AMMONIA (NH3)</b> .....	<b>76</b>
<b>10.8 HYDROGEN CHLORIDE (HCL)</b> .....	<b>76</b>
<b>10.9 HYDROGEN FLOURIDE (HFL)</b> .....	<b>76</b>
<b>10.11 DIOXINS AND FURANS (D/F)</b> .....	<b>77</b>
<b>10.12 OVERALL RESULTS</b> .....	<b>78</b>
<b>10.13 AERMOD VER.9.1 MODEL MAXIMUM GROUND LEVEL CONCENTRATIONS IN</b> <b>AREA SENSITIVE RECEPTORS (ASR-GLCMAX)</b> .....	<b>79</b>
<b>11. RECOMMENDATIONS</b> .....	<b>80</b>
<b>12. RECOMMENDED AMBIENT AIR QUALITY MONITORING STATIONS</b> .....	<b>81</b>
ANNEX 3: MALDIVES MM5 2018 METEROLOGICAL DATA SCREENSHOT PROFILE MET DATA .....	84
ANNEX 4: MALDIVES MM5 2018 METEROLOGICAL DATA SCREENSHOT SURFACE MET DATA) .....	85
ANNEX 5: AERMOD VER. 9.7 SAMPLE PLOT FILES.....	86
<b>REFERENCES</b> .....	<b>186</b>

## LIST OF TABLES

Table 1: Wind direction frequency diagram for Maldives, 2018.....	19
Table 2: UTM Coordinates of Location of Area Sensitive Receptors (ASRs).....	28
Table 3: AERMOD BPIP.....	32
Table 4: Input Data for AERMOD Model Run 2 X 250 T/YR MW WTE Boiler and 0.8 MW Diesel Generator set.....	34
Table 5: Design emission concentration.....	34
Table 6: Design emission strength.....	34
Table 7: Summary Maximum Ground Level Concentration - AERMOD.....	36
TABLE 8: TABLE OF NOTEABLE PEAK VALUES IN AREA SENSITIVE RECEPTORS AREAS (ASRS).....	6

## LIST OF FIGURES

Figure 1: Schematic Diagram of the WTE Plant Boiler (per line) .....	11
Figure 2: Principle for the Gaussian Plume Model.....	14
Figure 3: Gaussian Dispersion Equation.....	15
Figure 4: Data flow in AERMOD Modeling System.....	16
Figure 5: MM5 Frequency Distribution of Wind Speed and Direction 2018 Maldives.....	18
Figure 6: MM5 Annual Wind Rose Wind Speed and Direction Windrose, 2018 Maldives.....	19
Figure 7: MM5 Surface Meteorology (SFC).....	20
Figure 8: MM5 Surface Meteorological Data MM5.....	20
Figure 9: MM5 Profile Meteorology (PFL).....	21
Figure 10: MM5 Profile Meteorological Data (PFL).....	21
Figure 11: AERMOD Treatment of Boundary Parameters.....	22
Figure 12: Domain of AERMOD Dispersion Modeling.....	23
Figure 13: 4 km X 4 km Model Domain (100 x 100 meters grid) .....	24
Figure 14: 4km X 4km Domain (100m X 100m Grid) Google Earth Overlay.....	24
Figure 15: Terrain effects in AERMOD SYSTEM.....	25
Figure 16: SRMT Terrain Elevation.....	26
Figure 17: SRMT Terrain Elevation Google Earth Overlay.....	26
Figure 18: Location of the ASRs and SRMT Terrain.....	27
Figure 19: Building Coordinates.....	28
Figure 20: Building Perimeter of WTE Plant.....	28
Figure 21: Building Area of WTE Plant.....	29
Figure 22: AERMOD Source Influence Zones of buildings to plume dispersion.....	30
Figure 23: Building Source Influence Zones of buildings to plume dispersion.....	30
Figure 24: Location of Maximum Predicted Ground Level Concentration.....	36
Figure 25: Total Dust (TD) (1 HR) (Isopleth in microgram/m3) .....	37
Figure 26: TD (24 HR) ( 1-HR RUN) (Isopleth in microgram/m3).....	38
Figure 27: Total Dust 1YR (Isopleth in microgram/m3) .....	39
Figure 28: Total Dust 1YR Deposition (Isopleth in microgram/m3.....	40
Figure 29: PM10 1 HR (Isopleth in microgram/m3).....	41
Figure 30: PM10 24 HR (Isopleth in microgram/m3).....	42
Figure 31: PM10 1 YR DEPOSITION (Isopleth in microgram/m3).....	43
Figure 32: SO2 1 HR (Isopleth in microgram/m3).....	44
Figure 33: SO2 24 HR (Isopleth in microgram/m3).....	45
Figure 34: SO2 1 YR (Isopleth in microgram/m3).....	46
Figure 35: NO2 1 HR (Isopleth in microgram/m3).....	47
Figure 36: NO2 24 HR (Isopleth in microgram/m3).....	48
Figure 37: NO2 1 YR (Isopleth in microgram/m3).....	49
Figure 38: Hg 1 HR (Isopleth in microgram/m3).....	50
Figure 39: Hg 24 HR (Isopleth in microgram/m3).....	51
Figure 40: Hg 1 year (Isopleth in microgram/m3).....	52
Figure 41: NH <sub>3</sub> 1 HR (Isopleth in microgram/m3).....	53
Figure 42: 5.19 NH <sub>3</sub> 24 HR (Isopleth in microgram/m3).....	54
Figure 43: HF 1 HR (Isopleth in microgram/m3).....	55
Figure 44: HF 24 HR (Isopleth in microgram/m3).....	56
Figure 45: Dioxin and Furans 1 HR (Isopleth in microgram/m3).....	57
Figure 46: Dioxin and Furans 24 HR (Isopleth in microgram/m3).....	58
Figure 47: HCl 1 HR (Isopleth in microgram/m3).....	59

Figure 48: HCl 24 HR (Isopleth in microgram/m <sup>3</sup> ).....	60
Figure 49: SB 1 HR (Isopleth in microgram/m <sup>3</sup> ).....	66
Figure 50: SB 24 HR (Isopleth in microgram/m <sup>3</sup> ).....	67
Figure 51: SB 1 YR (Isopleth in microgram/m <sup>3</sup> ).....	68
Figure 52: AS 1 HR (Isopleth in microgram/m <sup>3</sup> ).....	69
Figure 53: AS 24 HR (Isopleth in microgram/m <sup>3</sup> ).....	70
Figure 54: AS 1 YR (Isopleth in microgram/m <sup>3</sup> ).....	71
Figure 55: TL 1 HR (Isopleth in microgram/m <sup>3</sup> ).....	72
Figure 56: TL 24 HR (Isopleth in microgram/m <sup>3</sup> ).....	73
Figure 57: TL 1 YR (Isopleth in microgram/m <sup>3</sup> ).....	74
Figure 58: Recommended monitoring sites.....	81

## EXECUTIVE SUMMARY

AERMOD validation modeling was conducted in comparison with the Austal2000 German Lagrangian model. In said report, it was highly acknowledged that AERMOD is a “Stronger model” compared to Austal2000 in complex and urban terrain. It was also noted that Austal2000 was used as an alternative only because of the complexity of the meteorological data requirement of AERMOD. For the AERMOD validation run, the meteorological (metdata) provides a strong advantage because it accounts land use data, surface and upper air and its influence mechanical and convective mixing among other Planetary Boundary Layer (PBL) Parameters included met data set.

AERMOD meteorological data utilize surface characteristics in the form of albedo, surface roughness and Bowen ratio, plus standard meteorological observations such as wind speed, wind direction, temperature, and cloud cover. Using the AERMOD metdata processor AERMET, it calculates the PBL parameters such as: friction velocity, Monin-Obukhov length, convective velocity scale, temperature scale, mixing height, and surface heat flux . These parameters are then passed to the Interface within AERMOD where similarity expressions in conjunction with measurements are used to calculate vertical profiles of wind speed, lateral and vertical turbulent fluctuations, potential temperature gradient, and potential temperature. The AERMOD processes the MM5 formatted data to generate \*.SFC and \*.PFL met data files. See snapshot of the generated \*.SFC met data file and \*PFL met data file. Figure below also shows the AERMOD treatment of boundaries parameters.

In the same way as the Austal2000 model, AERMOD validation run has considered the effects of building downwash. Waste to Energy (WTE) dimensions: Approx. Length x width x height [m]: 100 x 70 x 30. Surrounding building location have been considered according to land use plan, topographical survey and Google Earth maps. The height of the buildings has been considered to maximum 10m. This is another strong feature in AERMOD that the aerodynamic turbulence induced by nearby buildings cause a pollutant emitted from an elevated source to be mixed rapidly toward the ground (downwash), resulting in higher ground-level concentrations.

Terrain effects, such as elevations, were also incorporated which have impact on the air dispersion, deposition modeling results and potential risk to human health and the environment. Terrain elevation is the elevation relative to the facility base elevation. Complex Terrain are those elevations defined as anywhere within 50 km from the stack, are above the top of the stack being evaluated in the air modelling analysis. Terrain consideration was determined using SRTM3 terrain data processed by AERMAP terrain processor and has noted that highest elevations in the project area is at 7 meters only above sea level. Nevertheless, this AERMOD validated executed terrain situations using SRTM3 terrain data processed by AERMAP terrain processor where model considers terrain height exceeds stack base elevation, model receptors are also assumed on elevated terrain. Terrain elevations for receptors in the receptor Pathway are also considered.

Output of model run includes: one (1) hour, twenty-four (24) hour, and one (1) year averaging time plot files, isopleths diagrams, and table of worst-case scenarios. Meteorological data used is based on TIER 4 meteorological data, NCAR MM5 (5th-generation Mesoscale Model) prognostic meteorological model was the basis for meteorological background of the areas. Prognostic MM5 meteorological model are specified location and site domain. Once the MM5 preprocessing has been completed, the MM5 output file is converted into a format recognized by the **AERMET model** (meteorological preprocessor for the AERMOD model). The final output is generated by creating a pseudo met-station at the specified site location.

## AREA SENSITIVE RECEPTORS (ASRs)

Area Sensitive Receptors (ASRs) include, but are not limited to residential areas, hospitals, schools, daycare facilities, elderly housing and convalescent facilities. These are areas where the occupants are more susceptible to the adverse effects of exposure to air pollutants. Extra monitoring and abatement efforts must be taken when dealing with contaminants and pollutants in close proximity to areas recognized as ASRs. For the WTE project and for the purpose of assessing potential impacts, Thilafushi islands' industrial areas are considered as ASRs as there are identified facilities with workers quarters. ASRs are located in the following area and details are provided in the main text of this report: (1.) ASR1-ENE; (2.) ASR2-SSE; (3.) ASR3-NNE; (4.) ASR4- SSW; (5) ASR5-NNW 474 to 1273 meters upwind and downwind directions from the center of the domain at UTM coordinates Easting 326540 and Northing 462472. This AERMOD Report includes results of the dispersion model showing the highest predicted ground level concentrations (GLC) in the ASRs.

The results and outputs of the models are compared with TA Luft Standards as specified in the Austal2000 Report and applicable United States Environmental Protection Agency (USEPA) standards and World Health Organization (WHO) Air Quality Guidelines.

## TOTAL DUST (TD)

Predicted short term (1 hour) for controlled<sup>1</sup> total dust (TD) maximum ground level concentrations is 7.60 ug/m<sup>3</sup> located 280 meters ENE from the center of the domain. The 24 hour controlled total dust (TD) maximum ground level concentrations is 3.188 ug/m<sup>3</sup> located 608 meters ENE from the center of the domain. Simulated concentrations for maximum ground level concentration for 1 hour total dust (TD) are generally very low. There is no available the Ambient Air Quality Standards for total dust in the Austal2000 Report. For the total dust (TD) deposition, AERMOD results shows 0.00754 g/m<sup>2</sup> for 1 hour, 0.038505 g/m<sup>2</sup> for 24 hr, and 0.43394 g/m<sup>2</sup> for 1 year deposition. Deposition simulations are all below the TALuft precipitation limit of 0.35 g/m<sup>2</sup>-d. There are no applicable USEPA standards and WHO Air Quality Guideline Values. Reference center of the domain is the location of the Boiler Stack-1 at Universal Transverse Mercator (UTM) coordinates Easting 326540 and Northing 462472.

### Summary Maximum Ground Level Concentration using AERMOD

Parameters	Ave.Time	Results	German Standard (TA Luft)		USEPA	WHO Air Quality Guidelines	% of the Applicable Standards
			Conc (ug/Nm <sup>3</sup> )	Conc (ug/Nm <sup>3</sup> )	Deposition (g/m <sup>2</sup> )	Conc (ug/Nm <sup>3</sup> )	Conc (ug/Nm <sup>3</sup> )
Total Dust	1 hour	7.60628	-	-	-	-	-
Total Dust	24 hour	3.18863	-	-	-	-	-
Total Dust	1 year	0.34134	-	0.35	-	-	-

## PARTICULATE MATTER 10 (PM10)

Predicted short term (1 hour) for controlled particulate matter 10 (PM-10) maximum ground level concentrations is 0.102 ug/m<sup>3</sup> located 100 meters E from the center of the domain. The 24-hour controlled PM-10 maximum ground level concentrations is 0.02844 ug/m<sup>3</sup> located

<sup>1</sup> Controlled emission parameters refer to post-air pollution control devices. For the WtE, each stack will include baghouse and electrostatic precipitators.



100 meters E from the center of the domain. Simulated concentration for maximum ground level concentration for 24 hour PM10 is below the 35 ug/m<sup>3</sup> TA Luft standards. There is no available Ambient Air Quality Standards for PM-10 in the Austal2000 report. For the PM-10 deposition, AERMOD results shows 0.00037 g/m<sup>2</sup> for 1 hour, 0.0007g/m<sup>2</sup> for 24 hour and 0.025 g/m<sup>2</sup> for 1 year deposition. There is no TALuft limit for PM10 for 1-hour in the Austal2000 report. Results are below TA Luft and WHO Air Quality Guideline Values. There are no USEPA standards in ug/Nm<sup>3</sup> unit, the values used are converted from parts per billion by volume (ppbv). The results show insignificant increase of 0.51% for 1-hour, 0.06% for 24-hour, and 0.01% for 1-year. Reference center of the domain is the location of the Boiler Stack-1 at UTM coordinates Easting 326540 and Northing 462472.

**Summary Maximum Ground Level Concentration using AERMOD**

Parameters	Ave.Time	Results	German Standard (TA Luft)		USEPA	WHO Air Quality Guidelines	% of the Applicable Standards
			Conc (ug/Nm <sup>3</sup> )	Conc (ug/Nm <sup>3</sup> )	Deposition (g/m <sup>2</sup> )	Conc (ug/Nm <sup>3</sup> )	Conc (ug/Nm <sup>3</sup> )
PM10	1 hour	0.10288	-	-	-	20	0.51
PM10	24 hour	0.02844	50	-	150	50	0.06
PM10	1 year	0.0025	40	-	50	20	0.01

**SULFUR DIOXIDE (SO<sub>2</sub>)**

Predicted short term (1 hour) for controlled sulfur dioxide (SO<sub>2</sub>) maximum ground level concentrations is 10.34 ug/m<sup>3</sup> located 100 meters E from the center of the domain. The 24 hour controlled SO<sub>2</sub> maximum ground level concentrations is 2.85 ug/m<sup>3</sup> located 100 meters E from the center of the domain. For 1-year averaging time, results of maximum concentration is 0.25302 ug/m<sup>3</sup>. Results for maximum ground level concentration for 1 hour, 24 hour and 1 year SO<sub>2</sub> are all below the TA Luft standards of 350 ug/m<sup>3</sup> for 1 hour, 125 ug/m<sup>3</sup> for 24 hr and 50 ug/m<sup>3</sup> for 1 year respectively. There are no USEPA standards in ug/Nm<sup>3</sup> unit, the values used are converted from parts per billion by volume (ppbv). The results show insignificant increase of 4.88% for 1-hour, 14.29% for 24-hour, and 0.32% for 1-year. Reference center of the domain is the location of the Boiler Stack-1 at UTM coordinates Easting 326540 and Northing 462472.

**Summary Maximum Ground Level Concentration using AERMOD**

Parameters	Ave.Time	Results	German Standard (TA Luft)		USEPA	WHO Air Quality Guidelines	% of the Applicable Standards
			Conc (ug/Nm <sup>3</sup> )	Conc (ug/Nm <sup>3</sup> )	Deposition (g/m <sup>2</sup> )	Conc (ug/Nm <sup>3</sup> )	Conc (ug/Nm <sup>3</sup> )
SO2	1 hour	10.33980	350	-	212	-	4.88
SO2	24 hour	2.85793	125	-	365	20	14.29
SO2	1 year	0.25302	50	-	79	-	0.32

**NITROGEN OXIDES (NOX)**

Predicted short term (1 hour) for controlled NO<sub>2</sub> maximum ground level concentrations is 48.91 ug/m<sup>3</sup> located 100 meters E from the center of the domain. The 24 hour controlled NO<sub>2</sub> maximum ground level concentrations is 14.16 ug/m<sup>3</sup> located 100 meters E from the center of the domain. For 1 year averaging time, results of maximum NO<sub>2</sub> concentration is 2.1 ug/m<sup>3</sup>. Simulated concentration for maximum NO<sub>2</sub> ground level concentration for 1 year is below the TA

Luft standards of 40 ug/m3. There are no USEPA standards in parts per billion by volume (ppbv) therefore cannot be converted to ug/Nm3 unit. The results show increase of 24.46% for 1-hour, and 5.25% for 1-year if compared to WHO Air Quality Guidelines. Reference center of the domain is the location of the Boiler Stack-1 at UTM coordinates Easting 326540 and Northing 462472.

**Summary Maximum Ground Level Concentration using AERMOD**

Parameters	Ave. Time	Results	German Standard (TA Luft)		USEPA	WHO Air Quality Guidelines	% of the Applicable Standards
			Conc (ug/Nm3)	Conc (ug/Nm <sup>3</sup> )			
NO2(Nox)	1 hour	48.91013	200	-	100 ppb	200	24.46
NO2(Nox)	24 hour	14.16085	-	-	-	-	-
NO2(Nox)	1 year	2.10000	40	-	53 ppb	40	5.25

**MERCURY (HG)**

Predicted short term (1 hour) for controlled mercury (Hg) maximum ground level concentrations is 0.00643 ug/m3 located 100 meters E from the center of the domain. The 24 hour controlled Hg maximum ground level concentrations is 0.00178 ug/m3 located 100 meters E from the center of the domain. For 1 year averaging time, results of maximum concentration is 0.0057 ug/m3. There are no TA Luft, USEPA standards and WHO Air Quality Guideline Values. The results show insignificant increase of 0.18% for 24-hour and 3.14% for 1-year using TA Luft standards. Reference center of the domain is the location of the Boiler Stack-1 at UTM coordinates Easting 326540 and Northing 462472.

**Summary Maximum Ground Level Concentration using AERMOD**

Parameters	Ave. Time	Results	German Standard (TA Luft)		USEPA	WHO Air Quality Guidelines	% of the Applicable Standards
			Conc (ug/Nm3)	Conc (ug/Nm <sup>3</sup> )			
Hg	1 hour	0.00643	-	-	-	-	-
Hg	24 hour	0.00178	-	1	-	-	0.18
Hg	1 year	0.00157	-	0.05	-	-	3.14

**AMMONIA (NH<sub>3</sub>)**

Predicted short term (1 hour) for controlled ammonia (NH<sub>3</sub>) maximum ground level concentrations is 2.066 ug/m3 located 100 meters E from the center of the domain. The 24 hour controlled NH<sub>3</sub> maximum ground level concentrations is 0.57123 ug/m3 located 100 meters E from the center of the domain. There are no NH<sub>3</sub> TA Luft standards in the Austal2000 report. There are no USEPA standards and WHO Air Quality Guideline Values. Reference center of the domain is the location of the Boiler Stack-1 at UTM coordinates Easting 326540 and Northing 462472.

**Summary Maximum Ground Level Concentration using AERMOD**

Parameters	Ave. Time	Results	German Standard (TA Luft)		USEPA	WHO Air Quality Guidelines	% of the Applicable Standards
			Conc (ug/Nm3)	Conc (ug/Nm <sup>3</sup> )			

NH3	1 hour	2.06667	-	-	-	-	-
NH3	24 hour	0.57123	-	-	-	-	-
NH3	1 year	0.00147	-	-	-	-	-

### HYDROGEN CHLORIDE (HCL)

Predicted short term (1 hour) for controlled hydrogen chloride (HCl) maximum ground level concentrations is 2.066 ug/m<sup>3</sup> located 100 meters E from the center of the domain. The 24 hour controlled NH<sub>3</sub> maximum ground level concentrations is 0.57123 ug/m<sup>3</sup> located 100 meters E from the center of the domain. There are no HCl TA Luft standards in the Austal2000 report. There are no USEPA standards and WHO Air Quality Guideline Values. Reference center of the domain is the location of the Boiler Stack-1 at UTM coordinates Easting 326540 and Northing 462472.

Parameters	Ave. Time	Results	German Standard (TA Luft)		USEPA	WHO Air Quality Guidelines	% of the Applicable Standards
			Conc (ug/Nm <sup>3</sup> )	Conc (ug/Nm <sup>3</sup> ) Deposition (g/m <sup>2</sup> )			
HCl	1 hour	2.06667	-	-	-	-	-
HCl	24 hour	0.57123	-	-	-	-	-
HCl	1 year	0.00147	-	-	-	-	-

### HYDROGEN FLOURIDE (HF)

Predicted short term (1 hour) for controlled hydrogen fluoride (HF) maximum ground level concentrations is 2.066 ug/m<sup>3</sup> located 100 meters E from the center of the domain. The 24 hour controlled HF maximum ground level concentrations is 0.57123 ug/m<sup>3</sup> located 100 meters E from the center of the domain. There are no HF TA Luft standards in the Austal2000 report. There are no USEPA standards and WHO Air Quality Guideline Values. Reference center of the domain is the location of the Boiler Stack-1 at UTM coordinates Easting 326540 and Northing 462472.

Parameters	Ave. Time	Results	German Standard (TA Luft)		USEPA	WHO Air Quality Guidelines	% of the Applicable Standards
			Conc (ug/Nm <sup>3</sup> )	Conc (ug/Nm <sup>3</sup> ) Deposition (g/m <sup>2</sup> )			
Hf	1 hour	0.20705	-	-	-	-	-
Hf	24 hour	0.05723	-	-	-	-	-
Hf	1 year	0.00015	-	-	-	-	-

### DIOXINS AND FURANS (D/F)

Predicted short term (1 hour) for controlled Dioxins and Furans maximum ground level concentrations is 0.0258 ug/m<sup>3</sup> located 100 meters E from the center of the domain. The 24 hour controlled Dioxins and Furans maximum ground level concentrations is 0.00569 ug/m<sup>3</sup> located 100 meters E from the center of the domain. There are no Dioxins and Furans TA Luft standards in the Austal2000 report. There are no USEPA standards and WHO Air Quality Guideline Values. Reference center of the domain is the location of the Boiler Stack-1 at UTM coordinates Easting 326540 and Northing 462472.

Parameters	Ave.Time	Results	German Standard (TA Luft)		USEPA	WHO Air Quality Guidelines	% of the Applicable Standards
			Conc (ug/Nm <sup>3</sup> )	Conc (ug/Nm <sup>3</sup> ) Deposition (g/m <sup>2</sup> )			
D/F	1 hour	0.02058	-	-	-	-	-
D/F	24 hour	0.00569	-	-	-	-	-
D/F	1 year	0.00002	-	-	-	-	-

**SUM OF HEAVY METALS AND THEIR COMPONENTS: ANTIMONY, CHROMIUM, COPPER, MANGANESE, VANADIUM, TIN, LEAD, COBALT, NICKEL ( TA LUFT CLASS II AND III)**

Predicted short term (1 hour) for the Sum of heavy metals and their components: antimony, chromium, copper, manganese, vanadium, tin, lead, cobalt, nickel ( TA Luft class II and III) ground level concentrations is 1.3161 ug/m<sup>3</sup> located 316 meters NorthNorthEast (NNE) from the center of the domain. The 24 hour controlled total sum of metals maximum ground level concentrations is 0.4954 ug/m<sup>3</sup> located 141 meters NorthWest (NW) from the center of the domain. For 1 year averaging time, results of maximum concentration is 0.0982 ug/m<sup>3</sup>. Simulated concentrations for maximum ground level concentration for both 1, 24 hours & 1 Year averaging which are generally very low. Results are generally lower than US RSLs for combined 24 hr averaging for Cu, Vn, Cr and Mn of 0.152 ug/m<sup>3</sup> and the 3 month NAAQS for Lead of 0.15 ug/m<sup>3</sup>. There is no available the Ambient Air Quality Standards for said metals in the Austal2000 Report. Reference center of the domain is the location of the Boiler Stack-1 at UTM coordinates Easting 326540 and Northing 462472.

Parameters	Ave.Time	Results	German Standard (TA Luft)		USEPA	WHO Air Quality Guidelines	% of the Applicable Standards
			Conc (ug/Nm <sup>3</sup> )	Conc (ug/Nm <sup>3</sup> ) Deposition (g/m <sup>2</sup> )			
Sum of Metals (Sb) <sup>1</sup>	1 hour	1.31607	-	-	-	-	-
Sum of Metals (Sb) <sup>1</sup>	24 hour	0.49540	-	-	-	-	-
Sum of Metals (Sb) <sup>1</sup>	1 year	0.09818	-	-	-	-	-

<sup>1</sup>Sum of metals: Antimony, Chromium, Copper, Manganese, Vanadium, in, Lead, Cobalt, Nickel

**ARSENIC / CADMIUM AND ITS COMPOUNDS (EXPRESSED AS As AND Cd), BENZO (A) PYRENE, WATER-SOLUBLE COBALT COMPOUNDS (EXPRESSED AS CO), CHROMIUM (VI) COMPOUNDS (EXPRESSED AS CR) (TA LUFT CLASS I )**

Predicted short term (1 hour) for the Sum of heavy metals and their components: Arsenic / cadmium and its compounds (expressed as As and Cd), benzo (a) pyrene, water-soluble cobalt compounds (expressed as Co), chromium (VI) compounds (expressed as Cr) (TA Luft Class I ) ground level concentrations is 0.13161 ug/m<sup>3</sup> located 316 meters NorthNorthEast (NNE) from the center of the domain. The 24 hour controlled total sum of metals maximum ground level concentrations is 0.049 ug/m<sup>3</sup> located 141 meters NorthWest (NW) from the center of the domain. For 1 year averaging time, results of maximum concentration is 0.00982 ug/m<sup>3</sup>. Simulated

concentrations for maximum ground level concentration for both 1, 24 hours & 1 Year averaging which are generally very low. Results are generally lower than the available ESL for Arsenic of 3 ug/m<sup>3</sup> and 0.067 ug/m<sup>3</sup> for 1 year. There is no available the Ambient Air Quality Standards for said metals in the Austal2000 Report. Reference center of the domain is the location of the Boiler Stack-1 at UTM coordinates Easting 326540 and Northing 462472.

Parameters	Ave.Time	Results	German Standard (TA Luft)		USEPA	WHO Air Quality Guidelines	% of the Applicable Standards
			Conc (ug/Nm <sup>3</sup> )	Conc (ug/Nm <sup>3</sup> )	Deposition (g/m <sup>2</sup> )	Conc (ug/Nm <sup>3</sup> )	Conc (ug/Nm <sup>3</sup> )
Sum of Metals (As) <sup>1</sup>	1 hour	0.13161	-	-	-	-	-
Sum of Metals (As) <sup>1</sup>	24 hour	0.04954	-	-	-	-	-
Sum of Metals (As) <sup>1</sup>	1 year	0.00982	-	-	-	-	-

<sup>1</sup>Sum of metals: Arsenic / cadmium and its compounds (expressed as As and Cd), benzo (a) pyrene, water-soluble cobalt compounds (expressed as Co), chromium (VI) compounds (expressed as Cr)

### THALLIUM AND ITS COMPOUNDS ( TA LUFT CLASS I) CADMIUM

Predicted short term (1 hour) for the Sum of heavy metals and their components: Thallium and its compounds ( TA Luft class I) cadmium ground level concentrations is 0.13161 ug/m<sup>3</sup> located 316 meters NorthNorthEast (NNE) from the center of the domain. The 24 hour controlled total sum of metals maximum ground level concentrations is 0.049 ug/m<sup>3</sup> located 141 meters NorthWest (NW) from the center of the domain. For 1 year averaging time, results of maximum concentration is 0.00982 ug/m<sup>3</sup>. Simulated concentrations for maximum ground level concentration for both 1, 24 hours & 1 Year averaging which are generally very low. There is no available the Ambient Air Quality Standards for said metals in the Austal2000 Report and in the USEPA NAAQS, ESLs and RSLs. Reference center of the domain is the location of the Boiler Stack-1 at UTM coordinates Easting 326540 and Northing 462472.

Parameters	Ave.Time	Results	German Standard (TA Luft)		USEPA	WHO Air Quality Guidelines	% of the Applicable Standards
			Conc (ug/Nm <sup>3</sup> )	Conc (ug/Nm <sup>3</sup> )	Deposition (g/m <sup>2</sup> )	Conc (ug/Nm <sup>3</sup> )	Conc (ug/Nm <sup>3</sup> )
Sum of Metals (Tl) <sup>1</sup>	1 hour	0.13161	-	-	-		
Sum of Metals (Tl) <sup>1</sup>	24 hour	0.04954	-	-	-		
Sum of Metals (Tl) <sup>1</sup>	1 year	0.00982	-	-	-		

<sup>1</sup>Sum of metals: Thallium and its compounds and cadmium

For all the above parameters, controlled emissions have been validated to be in compliance with the TA Luft Standards as provided in the Austal2000 Report and with the USEPA standards and the WHO Air Quality Guidelines.

## **RESULTS**

AERMOD validation of the Austal2000 model results shows slightly higher results than the Austal2000 report but still within TA Luft Standards and USEPA Standards. For the deposition results, Total Dust, SO<sub>2</sub>, NO<sub>2</sub> and Hg are confirmed to be way below the 1 year TA Luft precipitation standards. Toxic heavy metal parameters such Ni, Ti, As, Cd, and Pb was excluded in the validation model due to absence of design emission data.

Based on the design emission of the proposed WTE plant, proposed stack height of 50 meters in the Austal2000 report was found to be favorable considering all predicted ground level concentrations in the AERMOD validation model are below the TA Luft and USEPA standards.

## **RECOMMENDATIONS**

It recommended to (i) retain the four (4) ambient monitoring stations used in conducting ambient air quality in Thillafushi island for the EIA study; and (ii) put up additional ambient monitoring stations in ASR 2, ASR 3 and ASR 5 areas due to industrial facilities with workers quarters.

Background ambient air quality was not accounted in the modeling run. However given there are no potential significant sources of air pollution (such as mobile, area, line sources, community and other air-pollutant emitting industries) near the WTE plant, the results of both the Austal2000 and AERMOD models are generally acceptable and can be seen as below TA Luft and USEPA Standards. However, it is highly recommended to conduct a validation run after 1 to 3 months during operations stage using actual CEMS, stack testing, and ambient air monitoring results.

## 1. BACKGROUND INFORMATION

Atmospheric dispersion modeling is the mathematical simulation of how air pollutants disperse in the ambient atmosphere. The dispersion models are used to estimate the downwind ambient concentration of air pollutants emitted from sources. They can also be used to predict future concentrations under specific scenarios (i.e. changes in emission sources) and are most useful for pollutants that are dispersed over large distances and that may react in the atmosphere. advanced dispersion modeling programs include a pre-processor module for the input of meteorological and other data, and many also include a post-processor module for graphing the output data and/or plotting the area impacted by the air pollutants on maps. The plots of areas impacted may also include isopleths showing areas of minimal to high concentrations that define areas of the highest health risk. The isopleths plots are useful in determining protective actions for the public and responders.

### Objectives of This Study<sup>2</sup>

The objectives of this validation studies are: (i) evaluation of Austal2000 model conducted as part of the EIA study; (ii) compare results with relevant TA Luft and USEPA standards and guidelines; and (iii) identify and forecast levels of relevant pollutants at different area sensitive receptors (ASRs) in Thillafushi to assess effects of air quality with regards to human health, risks and environment.

### Component of the WTE Plant<sup>3</sup>

The WTE plant shall be designed and built as a conventional state-of-the-art grate type incinerator of two lines of 250 Mg/d each (total of 500 Mg/d), that shall consist of the following main set of process units and plant components:

- a) Waste reception, storage and feeding consisting of a weigh bridge incl. guard house, tipping hall and waste bunker, a shredder and waste cranes;
- b) Thermal treatment consisting of combustion system; boiler and heat recovery system and boiler feed water and make-up water system;
- c) Air pollution control (APC) system and ID fan and stack and continuous emission monitoring system (CEMS);
- d) Turbine with generator and condenser, cooling water pre-treatment system and cooling water pumps;
- e) Other balance of plant components incl. fuel and chemicals supply and storage; fire-fighting water supply system; wastewater treatment plant for sewerage, water supply system;
- f) Bottom ash treatment plant incl. bottom ash bunker and conveying system;
- g) Residue sanitary landfill and leachate collection, management and treatment system;
- h) Electric system incl. connection to public network

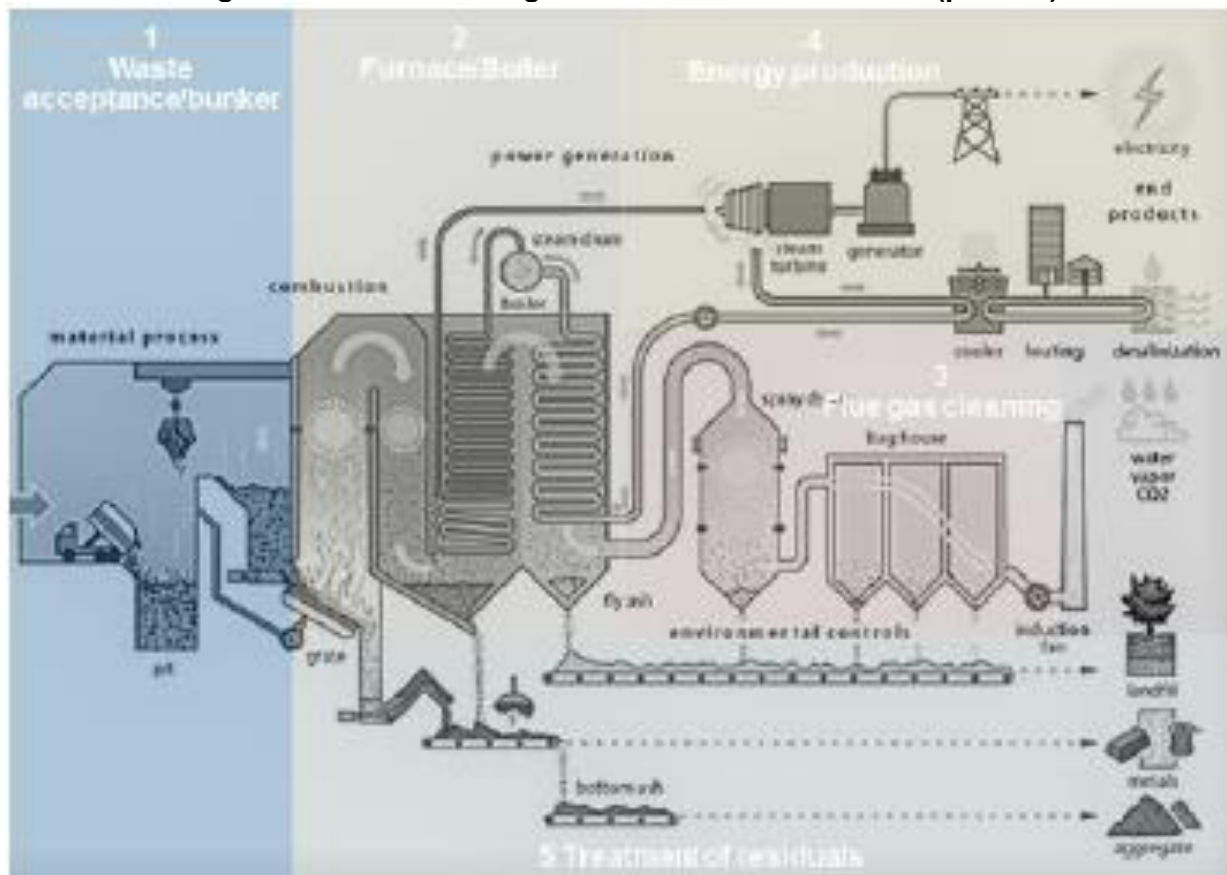
All process units and the balance of plant components are to be equipped with necessary electrical and control components, with valves, fittings, piping, utility mains etc. and shall be combined to a fully functional system that is fit for purpose and that is operated and controlled by a **DCS** which shall facilitate monitoring and recording of operational data.

---

<sup>2</sup> Greater Male' Waste to Energy Project Environmental (EIA) Waste to Energy Facility in Thilafushi

<sup>3</sup> Greater Male' Waste to Energy Project Environmental (EIA) Waste to Energy Facility in Thilafushi

**Figure 1: Schematic Diagram of the WTE Plant Boiler (per line)**



## 2. The Study Area

The WTE plant will be located on a 27 hectares government-owned land, of which 15 hectares have been reclaimed from shallow lagoon in Thilafushi island. It is on the southern rim of North Malé atoll, and on the eastern line of atolls within the archipelago. Thilafushi is located 9.5 km from Malé. In terms of geographic coordinates, it is located at 04° 11' 00" N and 73° 26' 44" E. The nearest inhabited island is Villingili, approximately 7.1 km east of Thilafushi.

## 3. Air Pollutants of Concern

### Particulate Matter Emissions (PM)

Particulate matter (PM) can vary greatly in size with diameters ranging from less than 1 micrometer to hundreds of micrometers ( $\mu\text{m}$ ). Fine particulates, having diameters less than  $10\mu\text{m}$  (known as PM-10), are of increased concern because a greater potential for inhalation and passage into the pulmonary region exists. Further, acid gases, metals, and toxic organics may preferentially adsorb onto particulates in this size range. Particulate emissions may be categorized as either filterable or condensable. Filterable emissions are generally considered to be the particles that are trapped by the glass fiber filter in the front half of USEPA Reference Method 5 or Method 17. Vapors and particles less than 0.3 microns pass through the filter. Condensable particulate matter is material that is emitted in the vapor state which later condenses



to form homogeneous and/or heterogeneous aerosol particles. The condensable particulate emitted from boilers is primarily inorganic in nature.

The level of PM at the inlet of the APC SYSTEM will vary according the combustor design, air distribution, waste characteristics, and the combustor's operation. Under normal combustion conditions, solid fly ash particulates formed from inorganic, noncombustible constituents in MSW are released into the flue gas. Most of this particulate is captured by the facility's APC system and are not emitted to the atmosphere.

### **Carbon Monoxide Emissions (CO)**

The presence of carbon monoxide (CO) in the exhaust gases of combustion systems results principally from incomplete fuel combustion. High levels of CO indicate that the combustion gases were not held at a sufficiently temperature in the presence of oxygen (O<sub>2</sub>) for a long enough time to convert CO to carbon dioxide (CO<sub>2</sub>). Several conditions can lead to incomplete combustion, including insufficient oxygen (O<sub>2</sub>) availability; poor fuel/air mixing; cold-wall flame quenching; reduced combustion temperature; decreased combustion gas residence time; and load reduction (i.e., reduced combustion intensity).

By controlling the combustion process carefully, CO emissions can be minimized. Thus, if a unit is operated improperly or not well maintained, the resulting concentrations of CO (as well as organic compounds) may increase by several orders of magnitude. Smaller boilers, heaters, and furnaces tend to emit more of these pollutants than larger combustors. This is because smaller units usually have a higher ratio of heat transfer surface area to flame volume than larger combustors have; this leads to reduced flame temperature and combustion intensity and, therefore, lower combustion efficiency.

Since various combustion modifications for NO<sub>x</sub> reduction can produce one or more of the mentioned conditions, the possibility of increased CO emissions is a concern for environmental, energy efficiency, and operational reasons.

### **Nitrogen Oxides Emissions (NOX)**

Oxides of nitrogen (NO<sub>x</sub>) formed in combustion processes are due either to thermal fixation of atmospheric nitrogen in the combustion air ("thermal NO<sub>x</sub>"), or to the conversion of chemically-bound nitrogen in the fuel ("fuel NO<sub>x</sub>"). The term NO<sub>x</sub> refers to the composite of nitric oxide (NO) and nitrogen dioxide (NO<sub>2</sub>). Test data have shown that for most external fossil fuel combustion systems, over 95 percent of the emitted NO<sub>x</sub> is in the form of nitric oxide (NO). Nitrous oxide (N<sub>2</sub>O) is not included in NO<sub>x</sub> but has recently received increased interest because of atmospheric effects. The formation of thermal NO<sub>x</sub> is affected by four factors: (1) peak temperature, (2) fuel nitrogen concentration, (3) oxygen concentration, and (4) time of exposure at peak temperature. The emission trends due to changes in these factors are generally consistent for all types of boilers: an increase in flame temperature, oxygen availability, and/or residence time at high temperatures leads to an increase in NO<sub>x</sub> production.

Conversion of nitrogen in the waste occurs at relatively low temperatures (less than 109 °C), while fixation of atmospheric nitrogen occurs at higher temperatures. Because of the relatively low temperatures at which WTE plants operate, 70 to 80% of NO formed is associated with nitrogen in the waste.<sup>4</sup>

---

<sup>4</sup> USEPA AP 42- Chapter 2.1 Refuse Combustion

## **Sulfur Oxides Emissions (SOX)**

Sulfur oxides (SO<sub>x</sub>) emissions are generated during combustion from the oxidation of sulfur contained in the fuel. The emissions of SO<sub>x</sub> are predominantly in the form of SO<sub>2</sub>. Uncontrolled SO<sub>x</sub> emissions are almost entirely dependent on the sulfur content of the fuel and are not affected by boiler size, burner design, or grade of fuel being fired. On average, more than 95% of the sulfur content in the municipal solid waste is converted to SO<sub>2</sub>, about 1% to 5% is further oxidized to sulfur trioxide (SO<sub>3</sub>), and 1% to 3% is emitted as sulfate particulate. SO<sub>3</sub> readily reacts with water vapor (both in the atmosphere and in flue gases) to form a sulfuric acid mist.

## **Metals Emissions and Acid Gases**

Metals are present in a variety of municipal solid waste streams are emitted from WTE plant in association with PM (e.g., arsenic [As], Cd, chromium [Cr], and Pb) and as vapors, such as Hg. Due to the variability in municipal solid waste composition, metal concentrations are highly variable and are essentially independent of combustor type. If the vapor pressure of a metal is such that condensation onto particulates in the flue gas is possible, the metal can be effectively removed by the PM control device. Except for mercury (Hg), most metals have sufficiently low vapor pressures which result in almost all of the metals being condensed. Therefore, removal in the PM control device for these metals is generally greater than 98%. Hg, on the other hand, has a high vapor pressure, but the level of carbon in the fly ash appears to affect the level of Hg control. A high level of carbon in the fly ash can enhance Hg adsorption onto particles. Hg can be removed in a typical APC system controlling the operating temperature and by the PM control device.<sup>5</sup>

The chief acid gases of concern from WTE plants are hydrochloric acid (HCl) and sulfuric acid (H<sub>2</sub>SO<sub>4</sub>) from SO<sub>2</sub>. Hydrogen fluoride (HF), hydrogen bromide (HBr), and sulfur trioxide (SO<sub>3</sub>) are also generally present, but at much lower concentrations. Concentrations of HCl and H<sub>2</sub>SO<sub>4</sub> in flue gases directly relate to the chlorine and sulfur content in the municipal solid waste the availability of alkali materials in combustion-generated fly ash that act as sorbents, and the type of APC system used. Acid gas concentrations are considered to be independent of combustion conditions.

## **Greenhouse Gases**

WTE plants involve generation of climate-relevant emissions such as CO<sub>2</sub> (carbon dioxide) as well as N<sub>2</sub>O (nitrous oxide), N<sub>2</sub>O, ammonia (NH<sub>3</sub>) and organic carbon, measured as total carbon. Methane (CH<sub>4</sub>) is not generated in a WTE plant during normal operation. It only arises, in exceptional cases and to a small extent (from waste remaining in the waste bunker), therefore that in quantitative terms CH<sub>4</sub> is not to be regarded as climate relevant.

CO<sub>2</sub> constitutes the chief climate-relevant emission of WTE plant. A WTE plant of 1 Mg of municipal solid waste is associated with the production/release of about 0.7 to 1.2 Mg of CO<sub>2</sub> output. The proportion of carbon of biogenic origin is usually in the range of 33% to 50%. The climate-relevant CO<sub>2</sub> emissions from WTE plants are determined by the proportion of waste whose carbon compounds are assumed to be of fossil origin. The allocation to fossil or biogenic carbon has a crucial influence on the calculated amounts of climate-relevant CO<sub>2</sub> emissions. An energy transformation efficiency equal to or greater than about 25% results in an allowable

---

<sup>5</sup> USEPA AP 42- Chapter 2.1 Refuse Combustion

average substituted net energy potential that renders the emission of WTE plants (calculated as CO<sub>2</sub> equivalents) climate-neutral due to the emission credits from the power plant mix.<sup>6</sup>

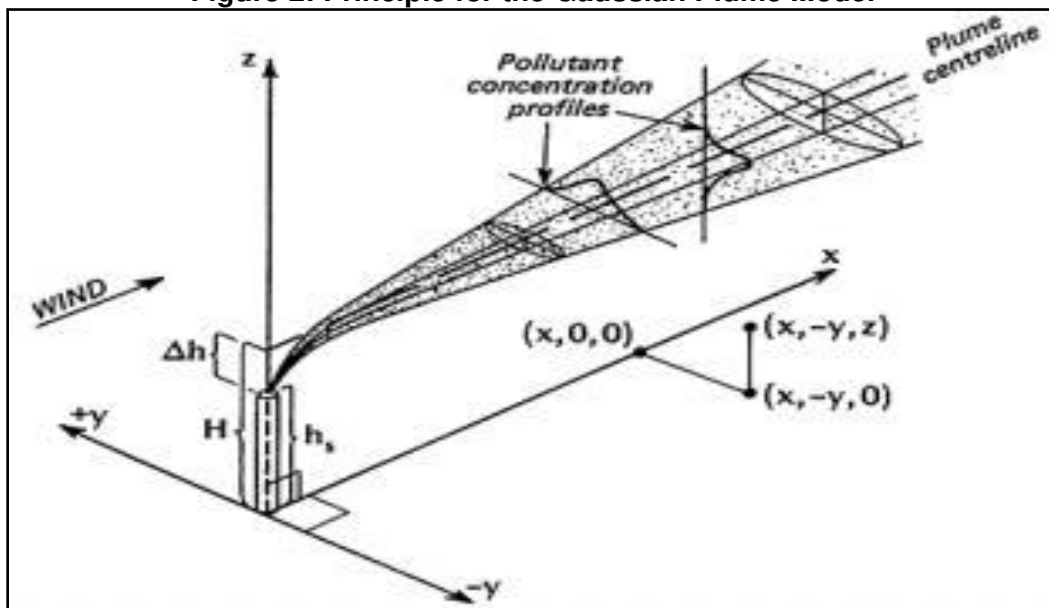
## The Air Dispersion Model

### Gaussian plume model

Gaussian plume model uses a realistic description of dispersion, where it represents an analytical solution to the diffusion equation for idealized circumstances. The model assumes that the atmospheric turbulence is both stationary and homogeneous. The model is the method of choice for many, especially for the prediction of yearly averaged concentration. It is the most widely used plume model and is the basis for most of the computer models distributed by the USEPA.

In the Gaussian plume dispersion model the concentration of pollution downwind from a source is treated as spreading outward from the centerline of the plume following a normal statistical distribution. The plume spreads in both the horizontal and vertical directions (Figure 2).

**Figure 2: Principle for the Gaussian Plume Model**



In the model, determining the pollutant concentrations at ground-level beneath an elevated plume involves two main steps:

- (i) first, the height to which the plume rises at a given downwind distance from the plume source is calculated. The calculated plume rise is added to the height of the plume's source point to obtain the so-called "effective stack height"
- (ii) second, the ground-level pollutant concentration beneath the plume at the given downwind distance is predicted using the Gaussian dispersion equation.

The Gaussian dispersion equation can be written as Figure 3:

<sup>6</sup> Good Practice Guidance and Uncertainty Management in National Greenhouse Gas Inventories, paper was written by Mr. Bernt Johnke (Germany) and reviewed by Robert Hoppaus (IPCC/OECD/IEA), Eugene Lee (US), Bill Irving (USEPA), T. Martinsen (IPCC/OECD/IEA), and K. Mareckova (IPCC/OECD/IEA).

**Figure 3: Gaussian Dispersion Equation**

$$C(x, y, z) = \frac{Q}{2\pi\sigma_y\sigma_z u} \exp\left(-\frac{y^2}{2\sigma_y^2}\right) \times \left\{ \exp\left(-\frac{(z-H)^2}{2\sigma_z^2}\right) + \exp\left(-\frac{(z+H)^2}{2\sigma_z^2}\right) \right\}$$

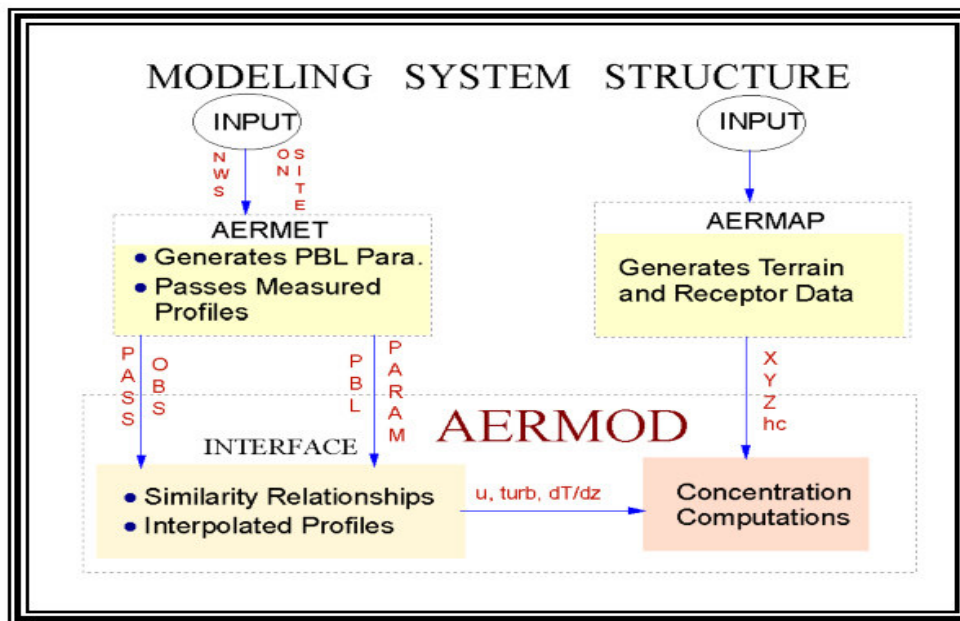
Where	C	=	concentration
	Q	=	emission rate of the pollutant from the source
	u	=	wind speed which defines the direction
	x, y	=	horizontal distance perpendicular to the wind direction
	z	=	vertical direction
	h <sub>s</sub>	=	Height of the source
	H	=	effective height of the plume (considering the additional height Δh to which the hot gases rise above the physical height of the source, h <sub>s</sub> ); i.e., H = h <sub>s</sub> + Δh
	σ <sub>y</sub> , σ <sub>z</sub>	=	parameters of the normal distributions in y and z directions, usually called the dispersion coefficients in y and z directions respectively

### AERMOD Modeling System

The American Meteorological Society/Environmental Protection Agency Regulatory Model Improvement Committee (AERMIC) was formed to introduce state-of-the-art modeling concepts into the USEPA's air quality models. Through AERMIC, a modeling system, AERMOD, was introduced that incorporated air dispersion based on planetary boundary layer turbulence structure and scaling concepts, including treatment of both surface and elevated sources, and both simple and complex terrain.

There are two input data processors that are regulatory components of the AERMOD modeling system: AERMET, a meteorological data pre-processor that incorporates air dispersion based on planetary boundary layer turbulence structure and scaling concepts, and AERMAP, a terrain data pre-processor that incorporates complex terrain using United States Geological Survey (USGS) Digital Elevation Data.

**Figure 4: Data flow in AERMOD Modeling System**



AERMOD is a steady-state plume model. In the stable boundary layer (SBL), it assumes the concentration distribution to be Gaussian in both the vertical and horizontal. In the convective boundary layer (CBL), the horizontal distribution is also assumed to be Gaussian, but the vertical distribution is described with a bi-Gaussian probability density function (pdf). This behavior of the concentration distributions in the CBL was demonstrated by Willis and Deardorff (1981) and Briggs (1993). Additionally, in the CBL, AERMOD treats “plume lofting,” whereby a portion of plume mass, released from a buoyant source, rises to and remains near the top of the boundary layer before becoming mixed into the CBL.

AERMOD also tracks any plume mass that penetrates the elevated stable layer, and then allows it to re-enter the boundary layer when and if appropriate. Using a relatively simple approach, AERMOD incorporates current concepts about flow and dispersion in complex terrain. Where appropriate the plume is modeled as either impacting and/or following the terrain. This approach has been designed to be physically realistic and simple to implement while avoiding the need to distinguish among simple, intermediate and complex terrain, as required by other regulatory models. As a result, AERMOD removes the need for defining complex terrain regimes. All terrain is handled in a consistent and continuous manner while considering the dividing streamline concept (Snyder et al. 1985) in stably stratified conditions.

### **Meteorology in the Study Area - Wind Rose**

The prevailing wind over the Maldives represents typical Asian monsoonal characteristics. It follows the traditional definition of monsoon as seasonal reversal of wind direction by more than 120° between the months January and July. Looking at annual variations, westerly winds are predominant throughout the country, varying between west-southwest and west-northwest.<sup>7</sup>

<sup>7</sup> Consultancy Services for Feasibility Study for an Integrated Solid Waste Management System for Zone III and Prepare Engineering Design of the Regional Waste Management Facility at Thilafushi

The southwest monsoon, with winds predominantly between SW and NW, lasts from May to October. In May and June, winds are mainly from WSW to WNW, and in July to October, winds between W and NW predominate. The northeast monsoon, with winds predominantly from NE to E, lasts from December to February. During March and April, winds are variable. During November, winds are primarily from the west, becoming variable and can occasionally exceed 30 knots from the NE sector. However, yearly wind speed in the northeast and southwest monsoons are observed to be between 9-13 knots.

As part of the recent update to the USEPA Guideline on Air Quality Models (EPA,2017), the use of prognostic data is allowed for regulatory applications of AERMOD where it is cost-prohibitive or not feasible to collect site-specific data and there is no representative weather data or comparable station nearby. EPA developed the Mesoscale Model Interface Program, or MMIF for processing prognostic meteorological data for AERMOD (Environ, 2014).

For the study area, meteorological data was obtained from Lakes Environmental [https://www.weblakes.com/services/met\\_data.html](https://www.weblakes.com/services/met_data.html) which employs the Weather Research and Forecasting (WRF) model<sup>8</sup> to compute accurate wind fields and provide modeled meteorological data. The data is obtained by running the Fifth-Generation Penn State/NCAR Mesoscale Model (MM5)<sup>9</sup> prognostic meteorological model for a specified location and site domain. Once the MM5 pre-processing has been completed, the MM5 output file is converted into a format recognized by the AERMET model. The final output is generated by creating a pseudo met-station at the specified site location.

Below is the frequency distribution and wind rose of Maldives for 2018 based on MM5 AERMET processed prognostic meteorological data.

---

<sup>8</sup> Weather Research and Forecasting (WRF) model is a numerical weather prediction (NWP) system designed to serve both atmospheric research and operational forecasting needs. NWP refers to the simulation and prediction of the atmosphere with a computer model, and WRF is a set of software for this. WRF features two dynamical (computational) cores (or solvers), a data assimilation system, and a software architecture allowing for parallel computation and system extensibility. The model serves a wide range of meteorological applications across scales ranging from meters to thousands of kilometres. WRF can produce simulations based on actual atmospheric conditions (i.e., from observations and analyses) or idealized conditions.

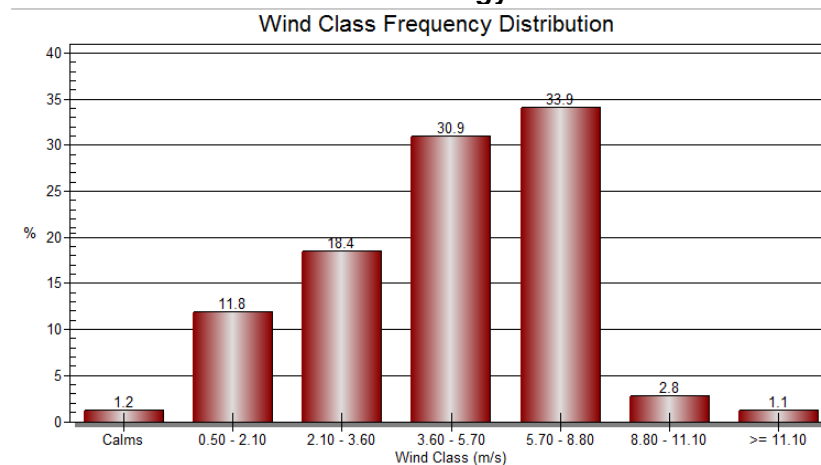
<sup>9</sup> It is a community model maintained by Penn State University and the National Center for Atmospheric Research. The MM5 is a limited-area, terrain-following sigma coordinate model that is used to replicate or forecast mesoscale and regional scale atmospheric circulation.

**Table 1: Wind Direction Frequency Diagram for Maldives, 2018**

	Directions / Wind Classes (m/s)	0.50 - 2.10	2.10 - 3.60	3.60 - 5.70	5.70 - 8.80	8.80 - 11.10	>= 11.10	Total
1	348.75 - 11.25	0.00502	0.00400	0.00731	0.00342	0.00000	0.00000	0.01975
2	11.25 - 33.75	0.00662	0.00628	0.01370	0.01199	0.00000	0.00000	0.03858
3	33.75 - 56.25	0.00765	0.01267	0.02500	0.01450	0.00137	0.00000	0.06119
4	56.25 - 78.75	0.00947	0.01267	0.02078	0.00970	0.00000	0.00000	0.05263
5	78.75 - 101.25	0.00811	0.01370	0.01290	0.00571	0.00000	0.00000	0.04041
6	101.25 - 123.75	0.00788	0.00993	0.00422	0.00285	0.00000	0.00011	0.02500
7	123.75 - 146.25	0.00639	0.00868	0.00685	0.00126	0.00000	0.00000	0.02317
8	146.25 - 168.75	0.00377	0.00742	0.01016	0.00354	0.00000	0.00000	0.02489
9	168.75 - 191.25	0.00491	0.00856	0.01587	0.00537	0.00000	0.00000	0.03470
10	191.25 - 213.75	0.00514	0.01438	0.02078	0.01769	0.00000	0.00000	0.05799
11	213.75 - 236.25	0.00913	0.01781	0.03185	0.05342	0.00148	0.00000	0.11370
12	236.25 - 258.75	0.00856	0.01747	0.04075	0.08950	0.01005	0.00616	0.17249
13	258.75 - 281.25	0.01005	0.01564	0.04669	0.06815	0.01107	0.00457	0.15616
14	281.25 - 303.75	0.00902	0.01450	0.02443	0.03779	0.00342	0.00034	0.08950
15	303.75 - 326.25	0.00970	0.01221	0.01975	0.00936	0.00011	0.00000	0.05114
16	326.25 - 348.75	0.00628	0.00788	0.00753	0.00502	0.00000	0.00000	0.02671
	Sub-Total	0.11769	0.18379	0.30856	0.33927	0.02751	0.01119	0.98801
	Calms							0.01199
	Missing/Incomplete							0.00000
	Total							1.00

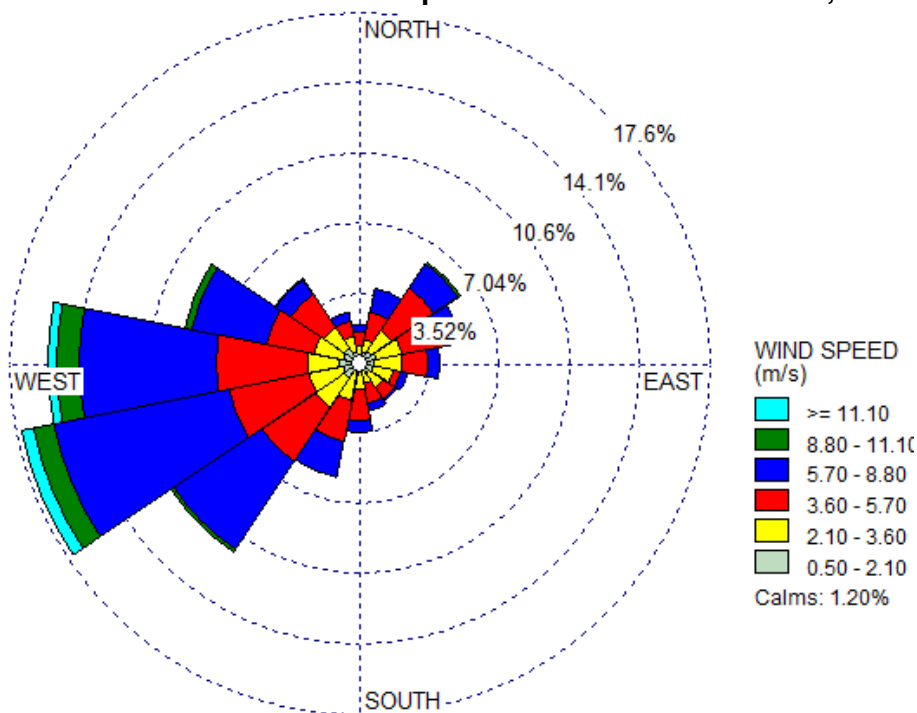
\* Reference bearing CW 90°

**Figure 5: MM5 Frequency Distribution of Wind Speed and Direction 2018 Maldives Meteorology**



Windrose diagram generated using WRPlot view Version 5.8 software which utilizes SCRAM (.DAT) files. Wind direction was oriented in "Blowing from" configuration. Figure 6 presents the annual wind rose diagram at Maldives Synoptic Station.

**Figure 6: MM5 Annual Wind Rose Wind Speed and Direction Windrose, 2018 Maldives**



Meteorological data such as stability classes and wind speeds, mixing height, cloud cover among other are considered this model run. TIER 3 meteorological data was used.

AERMET meteorological processor (EPA, 2018a) was applied to prepare the meteorological data for the AERMOD model (EPA, 2018b). Values for three surface characteristics: surface roughness length  $\{z_0\}$ ,<sup>10</sup> albedo  $\{r\}$ ,<sup>11</sup> and Bowen ratio  $\{Bo\}$ <sup>12</sup> were determined.

<sup>10</sup> The surface roughness length is related to the height of obstacles to the wind flow and is, in principle, the height at which the mean horizontal wind speed is zero based on a logarithmic profile. The surface roughness length influences the surface shear stress and is an important factor in determining the magnitude of mechanical turbulence and the stability of the boundary layer.

<sup>11</sup> The albedo is the fraction of total incident solar radiation reflected by the surface back to space without absorption.

<sup>12</sup> The daytime Bowen ratio, an indicator of surface moisture, is the ratio of sensible heat flux to latent heat flux and is used for determining planetary boundary layer parameters for convective conditions driven by the surface sensible heat flux.



**Figure 7: MM5 Surface Meteorology (SFC)**

File Header Data

Surface File Name: AER\_NAZZZ\_DAGUPSFC

Station Latitude: 16.000N      Upper Air Station ID: 1      Onsite Station ID: N/A

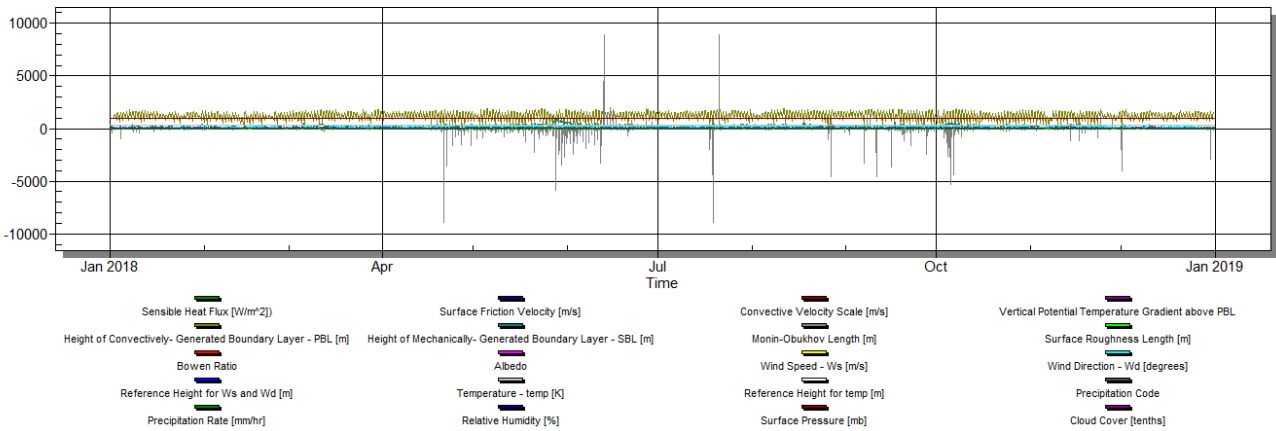
Station Longitude: 0.000W      Surface Station ID: 1      Version: 14134 CCVR\_SUB TEMP\_SUB

Filter: Year: 2004    Month: All    Day: All    Julian Day: All    Show All

Data Quality: Calms: 730 [hours] 8.31 [%]    Missing: 24 [hours] 0.27 [%]

	Year	Month	Day	Julian Day	Hour	Sensible Heat Flux [W/m <sup>2</sup> ]	Surface Friction Velocity [m/s]	Convective Velocity Scale [m/s]	Vertical Potential Temperature Gradient above PBL	Height of Convectively-Generated Boundary Layer - PBL [m]	Height of Mechanically-Generated Boundary Layer - SBL [m]	Monin-Obukhov Length [m]	Surface Roughness Length [m]	Bowen Ratio	Albedo	Wind Speed - Ws [m/s]	Wind Direction - Wd [degrees]	Reference Height for Ws and Wd [m]	Temperature - temp [K]	Reference Height for temp [m]	Precipitation Code
Min.	2004	Jan	1	1	1	-999.0	-9.000	-9.000	-9.000	-999.0	-999.0	-99999.0	-9.000	-9.00	-9.00	0.00	0.0	-9.0	295.1	-9.0	0
Max.	2004	Dec	31	366	24	397.6	0.866	2.809	0.005	4000.0	1934.0	8888.0	1.000	2.00	1.00	999.00	999.0	10.0	999.0	2.0	0
Graph						<input type="checkbox"/>	<input type="checkbox"/>	<input type="checkbox"/>	<input type="checkbox"/>	<input type="checkbox"/>	<input type="checkbox"/>	<input type="checkbox"/>	<input type="checkbox"/>	<input type="checkbox"/>	<input type="checkbox"/>	<input type="checkbox"/>	<input type="checkbox"/>	<input type="checkbox"/>	<input checked="" type="checkbox"/>	<input type="checkbox"/>	<input type="checkbox"/>
1	2004	Jan	1	1	1	-999.0	-9.000	-9.000	-9.000	-999.0	-999.0	-99999.0	1.000	2.00	1.00	0.00	0.0	10.0	301.1	2.0	0
2	2004	Jan	1	1	2	-999.0	-9.000	-9.000	-9.000	-999.0	-999.0	-99999.0	1.000	2.00	1.00	0.00	0.0	10.0	301.1	2.0	0
3	2004	Jan	1	1	3	-25.5	0.294	-9.000	-9.000	-999.0	382.0	89.8	1.000	2.00	1.00	2.10	144.0	10.0	301.1	2.0	0
4	2004	Jan	1	1	4	-45.7	0.493	-9.000	-9.000	-999.0	832.0	237.3	1.000	2.00	1.00	3.10	143.0	10.0	301.1	2.0	0
5	2004	Jan	1	1	5	-36.3	0.504	-9.000	-9.000	-999.0	859.0	318.9	1.000	2.00	1.00	3.10	143.0	10.0	301.1	2.0	0
6	2004	Jan	1	1	6	-36.3	0.504	-9.000	-9.000	-999.0	859.0	318.9	1.000	2.00	1.00	3.10	142.0	10.0	301.1	2.0	0
7	2004	Jan	1	1	7	-39.9	0.500	-9.000	-9.000	-999.0	849.0	282.6	1.000	2.00	1.00	3.10	145.0	10.0	301.1	2.0	0
8	2004	Jan	1	1	8	39.4	0.558	0.380	0.005	50.0	999.0	-397.9	1.000	2.00	0.33	3.10	163.0	10.0	301.1	2.0	0
9	2004	Jan	1	1	9	129.1	0.587	1.272	0.005	576.0	1078.0	-141.2	1.000	2.00	0.21	3.10	157.0	10.0	301.1	2.0	0
10	2004	Jan	1	1	10	202.1	0.603	1.676	0.005	840.0	1124.0	-97.9	1.000	2.00	0.18	3.10	161.0	10.0	301.1	2.0	0
11	2004	Jan	1	1	11	214.2	0.606	1.861	0.005	1087.0	1131.0	-93.6	1.000	2.00	0.17	3.10	184.0	10.0	301.1	2.0	0
12	2004	Jan	1	1	12	197.8	0.603	1.935	0.005	1324.0	1123.0	-99.8	1.000	2.00	0.16	3.10	176.0	10.0	301.1	2.0	0
13	2004	Jan	1	1	13	237.2	0.611	2.162	0.005	1541.0	1145.0	-86.6	1.000	2.00	0.16	3.10	183.0	10.0	301.1	2.0	0

**Figure 8: MM5 Surface Meteorological Data MM5**



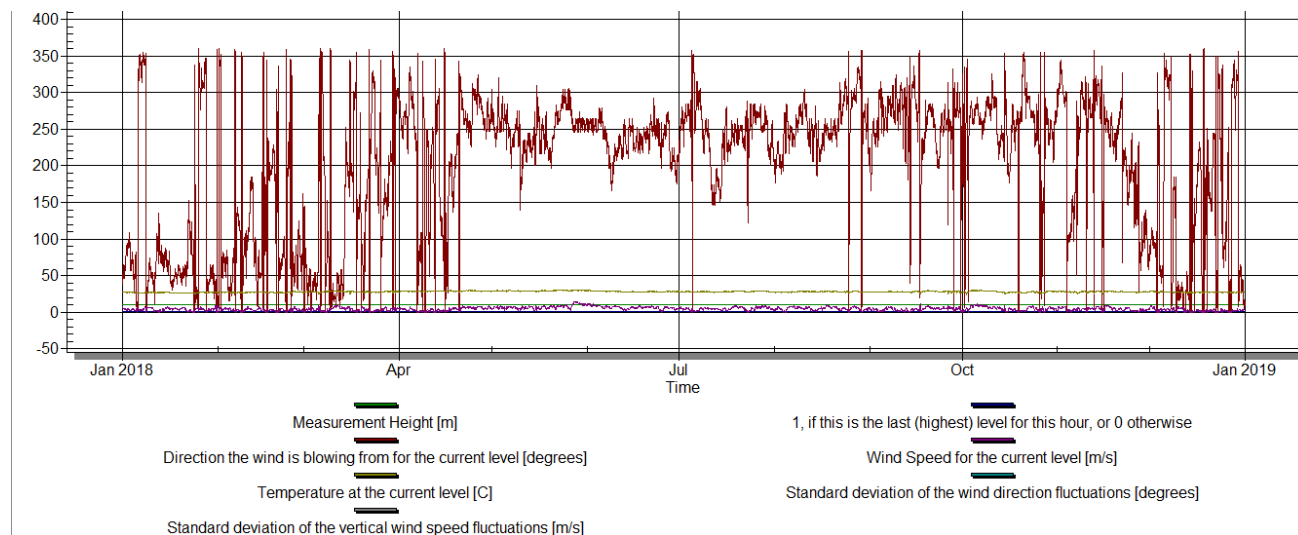
**Figure 9: MM5 Profile Meteorology (PFL)**

Filter  
 Year: All Month: All Day: All

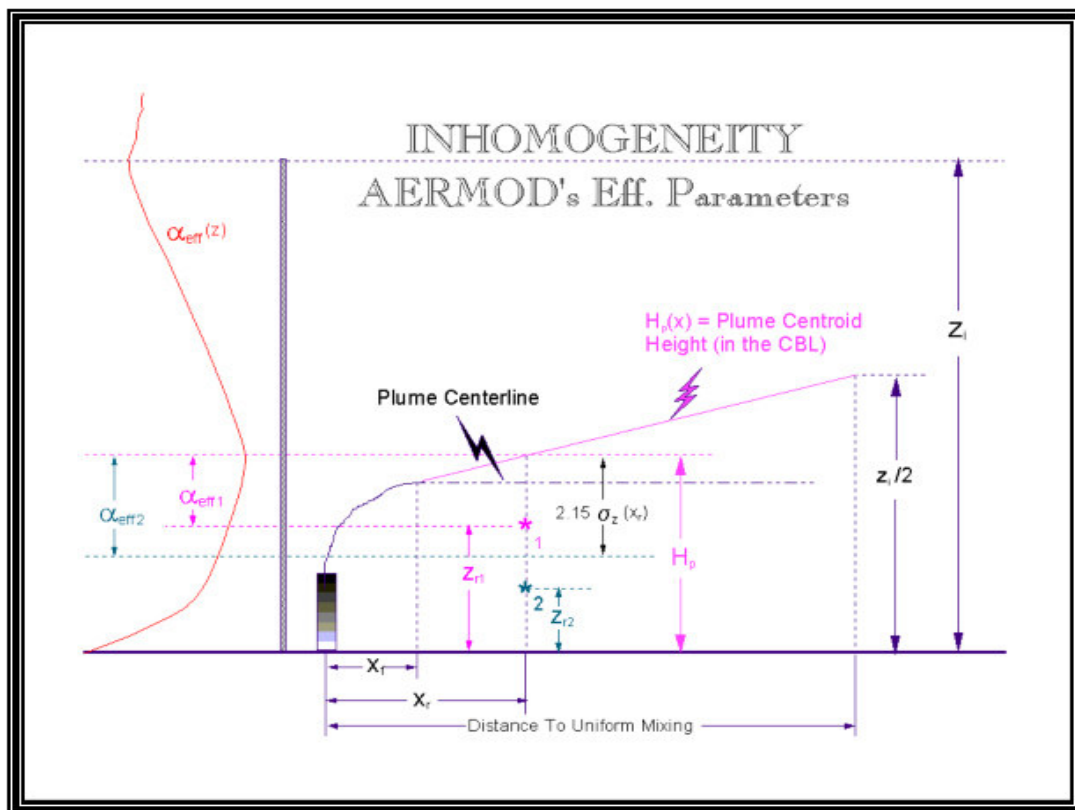
Table Graph

	Year	Month	Day	Hour	Measurement Height [m]	1, if this is the last (highest) level for this hour, or 0 otherwise	Direction the wind is blowing from for the current level [degrees]	Wind Speed for the current level [m/s]	Temperature at the current level [C]	Standard deviation of the wind direction fluctuations [degrees]	Standard deviation of the vertical wind speed fluctuations [m/s]
Min.	2004	Jan	1	1	10.0	1	0.0	0.00	22.0	99.0	99.00
Max.	2004	Dec	31	24	10.0	1	999.0	999.00	99.9	99.0	99.00
Graph					<input type="checkbox"/>	<input type="checkbox"/>	<input type="checkbox"/>	<input type="checkbox"/>	<input checked="" type="checkbox"/>	<input type="checkbox"/>	<input type="checkbox"/>
1	2004	Jan	1	1	10.0	1	0.0	0.00	28.0	99.0	99.00
2	2004	Jan	1	2	10.0	1	0.0	0.00	28.0	99.0	99.00
3	2004	Jan	1	3	10.0	1	144.0	2.10	28.0	99.0	99.00
4	2004	Jan	1	4	10.0	1	143.0	3.10	28.0	99.0	99.00
5	2004	Jan	1	5	10.0	1	143.0	3.10	28.0	99.0	99.00
6	2004	Jan	1	6	10.0	1	142.0	3.10	28.0	99.0	99.00
7	2004	Jan	1	7	10.0	1	145.0	3.10	28.0	99.0	99.00
8	2004	Jan	1	8	10.0	1	163.0	3.10	28.0	99.0	99.00
9	2004	Jan	1	9	10.0	1	157.0	3.10	28.0	99.0	99.00
10	2004	Jan	1	10	10.0	1	161.0	3.10	28.0	99.0	99.00
11	2004	Jan	1	11	10.0	1	184.0	3.10	28.0	99.0	99.00
12	2004	Jan	1	12	10.0	1	176.0	3.10	28.0	99.0	99.00
13	2004	Jan	1	13	10.0	1	183.0	3.10	28.0	99.0	99.00
14	2004	Jan	1	14	10.0	1	179.0	3.10	28.0	99.0	99.00
15	2004	Jan	1	15	10.0	1	322.0	3.10	28.0	99.0	99.00
16	2004	Jan	1	16	10.0	1	324.0	3.10	28.0	99.0	99.00
17	2004	Jan	1	17	10.0	1	321.0	3.10	28.0	99.0	99.00
18	2004	Jan	1	18	10.0	1	357.0	3.10	28.0	99.0	99.00
19	2004	Jan	1	19	10.0	1	4.0	3.10	28.0	99.0	99.00

**Figure 10: MM5 Profile Meteorological Data (PFL)**



**Figure 11: AERMOD Treatment of Boundary Parameters**



### Model Receptor Grid (Model Domain) and Grid Coordinates

The extent of the grid was chosen to include any regions of sensitive or important receptors such as residential areas and should also be sufficiently large to capture peak downwind pollutant predictions. For sources emitting pollutants close to ground level, the maximum ground-level concentration will be close to the source. However, for stack sources, the maximum ground-level concentration can be some distance away, and the model may have to be run more than once with increasing grid ranges to make sure the peak is captured.

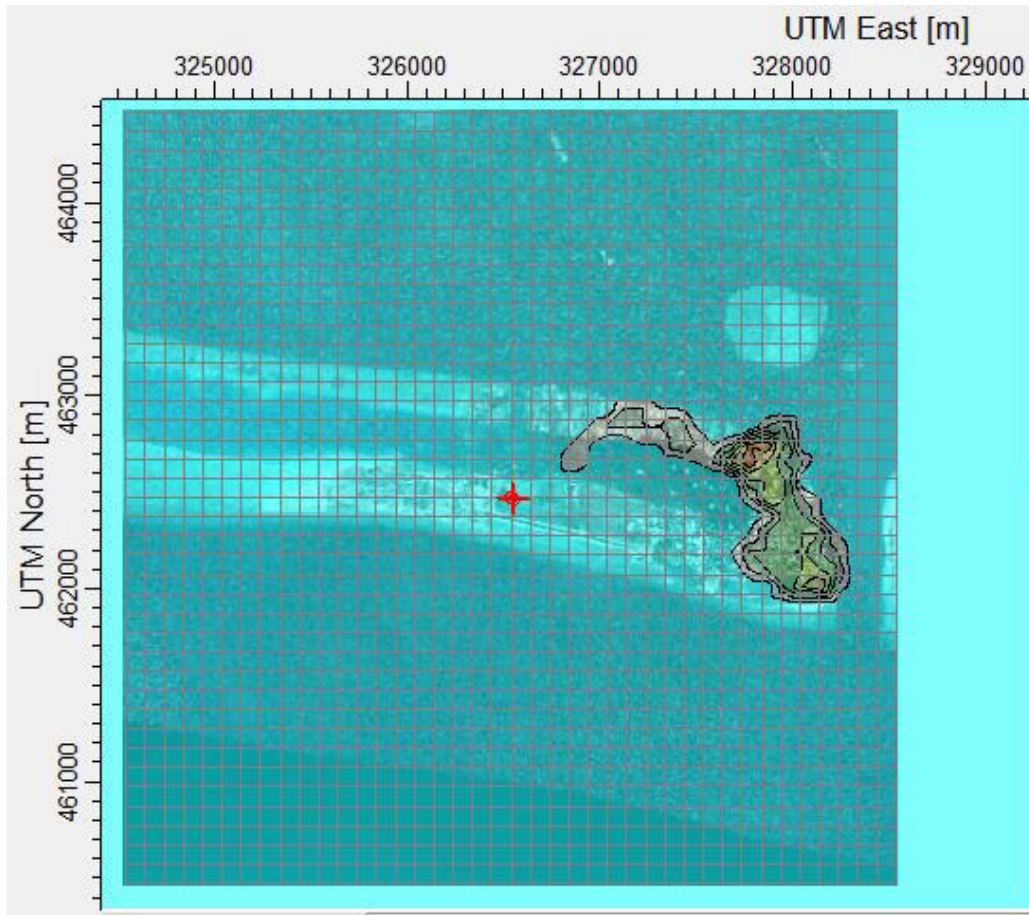
The WTE plan stack 1 (designated as origin) is assigned with coordinates 0,0 m and all site measurements can relate to this benchmark. All facility buildings and sources could then be related spatially to this origin.

Model domain covers 4,000 meters by 4,000 meters with 100 meter grid spacing. This is to cover area sensitive receptors (ASRs) near the WTE plant site and in Thilafushi. Center of the model domain is based on the location of the WTE plant's of 250 TPD boilers (2 units) and 0.8 mW diesel generator set. Figures 12 to 14 show the model domain.

**Figure 12: Domain of AERMOD Dispersion Modeling**



**Figure 13: 4 km X 4 km Model Domain (100 x 100 meters grid)**



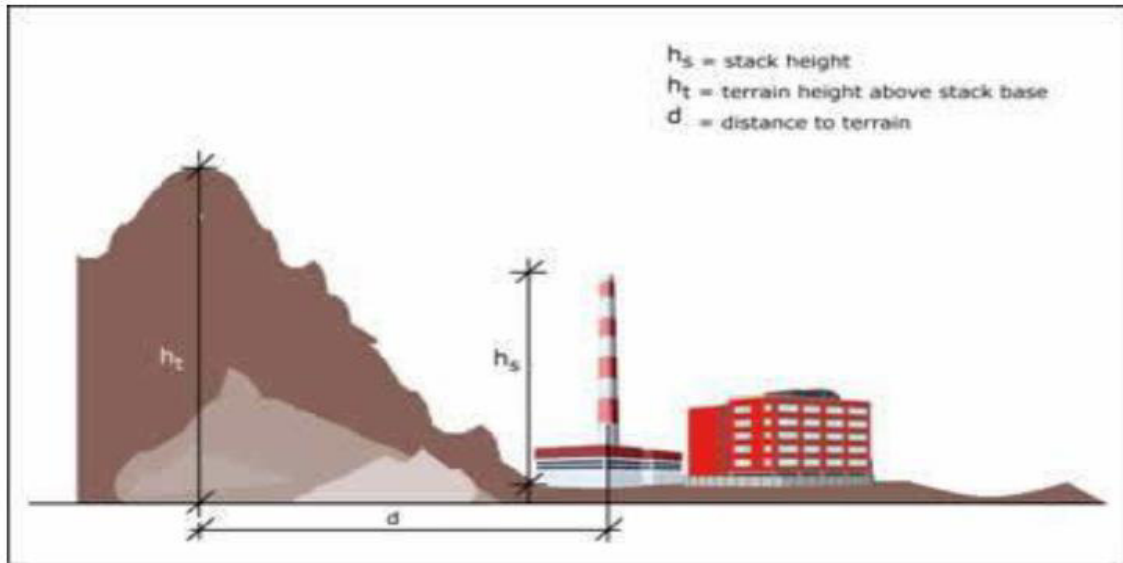
**Figure 14: 4km X 4km Domain (100m X 100m Grid) Google Earth Overlay**



## Terrain Effects

Terrain elevations have a large impact on the air dispersion and deposition modelling results. Terrain elevation is the elevation relative to the facility base elevation (Figure XXX).

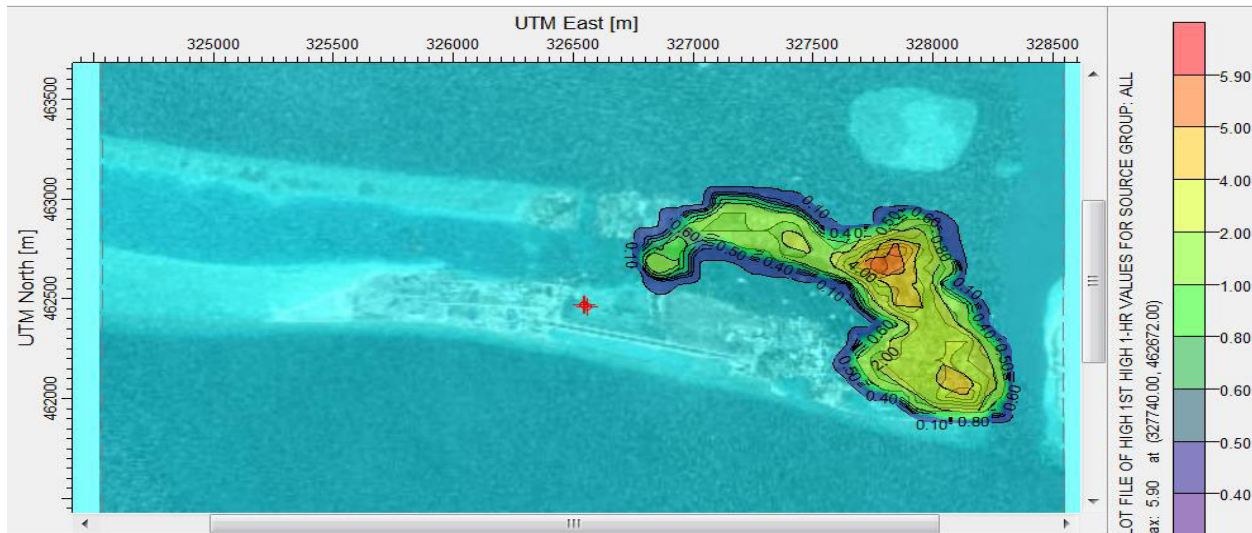
**Figure 15: Terrain effects in AERMOD SYSTEM**



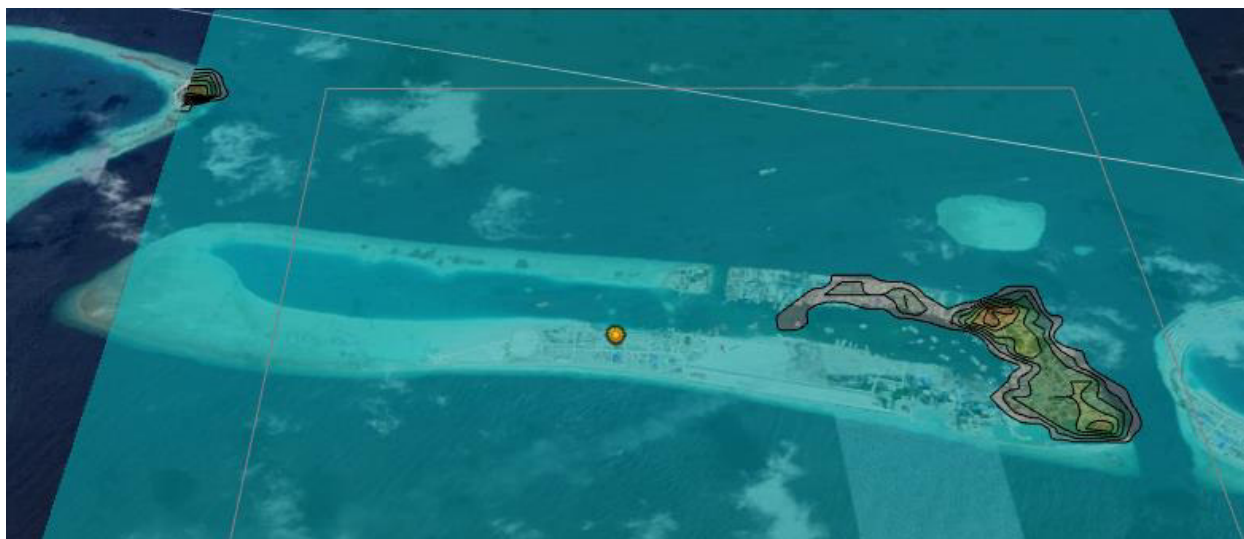
The AERMOD model utilized elected terrain using Shuttle Radar Topography Mission (SRTM3) terrain data processed by AEMAP terrain processor. This option assumes terrain height exceeds stack base elevation; model receptors are also assumed on elevated terrain. Terrain elevations for receptors in the receptor pathway are also considered. Elevated terrain is selected, and receptor heights are not specified, then it is assumed to have a value of 0.0 meters. Figures 16 to 17 provides the SRMT terrain elevation used in the modelling. Complex terrain illustrated in figures are those elevations defined as anywhere within 50 km from the stack, are above the top of the stack being evaluated in the air modelling analysis.

Surface characteristics at the measurement site influence boundary layer parameter estimates. These influences are quantified through the albedo, Bowen ratio, and surface roughness length. The surface roughness length is the height at which the mean horizontal wind speed approaches zero and is related to the surface roughness characteristics of the terrain. It is not equal to the physical dimensions of the obstacles to the wind flow but is generally proportional to them. The surface roughness length dialog provides empirically determined surface roughness length values (from Sheih et al., 1979) for various land use types for each season. In order to better quantify these characteristics, frequency that these characteristics change (annual, seasonal, or monthly) and the number of different sectors have been specified in the modelling.

**Figure 16: SRMT Terrain Elevation**



**Figure 17: SRMT Terrain Elevation Google Earth Overlay**



### Area Sensitive Receptors (ASRs)

Area Sensitive Receptors (ASRs) include, but are not limited to residential areas, hospitals, schools, daycare facilities, elderly housing and convalescent facilities. These are areas where the occupants are more susceptible to the adverse effects of exposure to air pollutants. Extra monitoring and abatement efforts must be taken when dealing with contaminants and pollutants in close proximity to areas recognized as ASRs.

For the WTE plant and for the purpose of assessing potential impacts, Thilafushi islands' industrial areas are considered as ASRs as there are identified facilities with workers quarters. ASRs are located in the following area and details are provided in the figure and table below: (1.) ASR1-ENE; (2.) ASR2-SSE; (3.) ASR3-NNE; (4.) ASR4- SSW; (5) ASR5-NNW 474 to 1273 meters upwind and downwind directions from the center of the domain at Universal Transverse

Mercator (UTM) coordinates Easting 326540 and Northing 462472. This AERMOD Report includes results of the dispersion model showing the highest predicted ground level concentrations (GLC) in the ASRs.

**Figure 18: Location of the ASRs and SRMT Terrain**



**Table 2: UTM Coordinates of Location of Area Sensitive Receptors (ASRs)**

	Long	Lat
ASR1	327811.66	462535.58
ASR2	327938.27	462105.3
ASR3	326838.73	462821.63
ASR4	326087.04	462454.99
ASR5	326415.56	462929

### Building Downwash

Building downwash occurs when the aerodynamic turbulence induced by nearby buildings cause a pollutant emitted from an elevated source to be mixed rapidly toward the ground (downwash), resulting in higher ground-level concentrations. Influence of buildings have been also considered in the model. The following building dimension and location (stack and Diesel genset) have been considered for the WTE plant. WTE dimensions: Approx. Length x width x height [m]: 100 x 70 x 30 Surrounded buildings location have been considered according land use plan, topographical survey and google earth maps. The height of the buildings have been considered to maximum 10 m<sup>13</sup>.

<sup>13</sup> Environmental and Social Impact Assessment (ESIA) Waste to Energy Facility Thilafushi



**Figure 19: Building Coordinates**

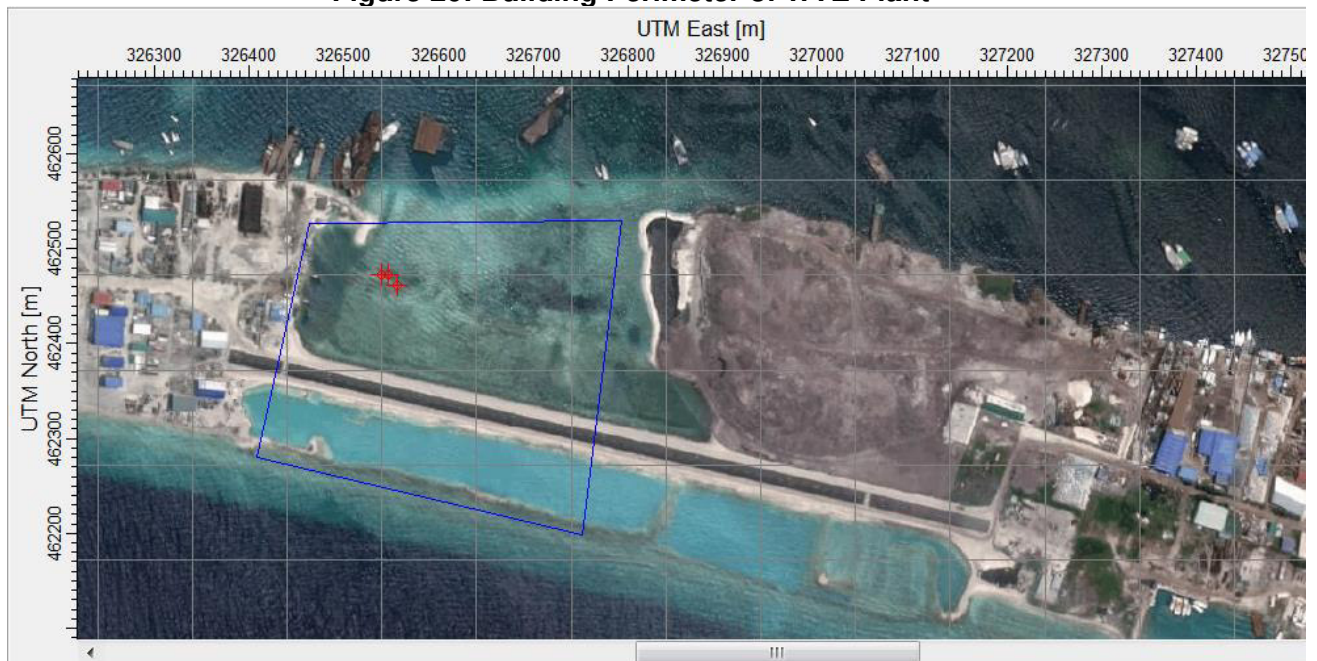
Coordinates	
North West:	4°10'58.73"N, 73°26'11.51"E
North East:	4°10'58.87"N, 73°26'22.20"E
South West:	4°10'50.71"N, 73°26'9.74"E
South East:	4°10'48.09"N, 73°26'20.87"E

Tier Corners		
#	X Coord [m]	Y Coord [m]
▶ 1	326463.89	462526.01
2	326793.57	462529.66
3	326751.00	462198.00
4	326408.81	462279.78

If stacks for new or existing major sources are found to be less than the height defined by EPA's refined formula for determining GEP height, then air quality impacts associated with cavity or wake effects due to the nearby building structures should be determined. (EPA 1986)

**Figure 20: Building Perimeter of WTE Plant**





**Figure 21: Building Area of WTE Plant**

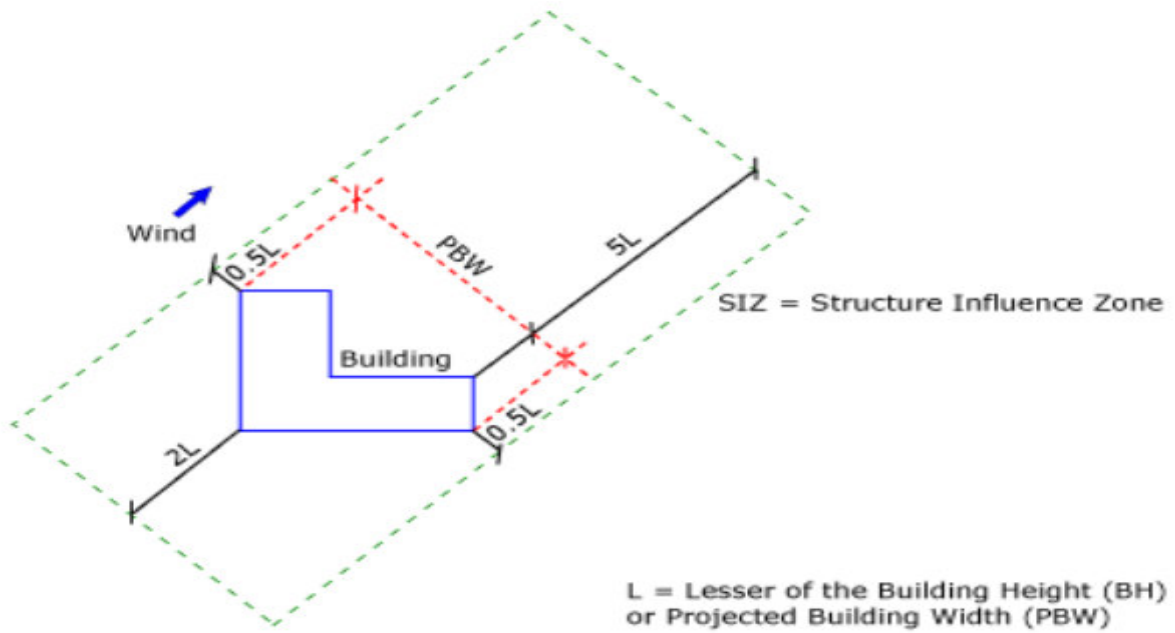
**GEP STACK HEIGHT =  $H + 1.5L$**

In EPA's refined formula for determining GEP stack height, consider Building Downwash for point sources that are within the GEP 5L Area of Influence of a building. For point sources within the GEP 5L Area of Influence, Building Downwash information (direction-specific building heights and widths) should be included in your ISC3 modeling project. Using AERMOD View, you can easily calculate these direction-specific building heights and widths. For regulatory applications, a building is considered sufficiently close to a stack to cause wake effects when the distance between the stack and the nearest part of the building is less than or equal to five (5) times the lesser of the building height or the projected width of the building.

**DISTANCE FROM STACK-BLDG  $\leq 5L$**

For building downwash analyses with direction-specific building dimensions, wake effects are assumed to occur if the stack is within a rectangle composed of two lines perpendicular to the wind direction, one at 5L downwind of the building and the other at 2L upwind of the building and by two lines parallel to the wind direction, each at 0.5L away from each side of the building, as shown below. L is the lesser of the height and projected width of the building for the particular direction sector. This rectangular area has been termed a **Structure Influence Zone (SIZ)**.

**Figure 22: AERMOD Source Influence Zones of buildings to plume dispersion**



**Figure 23: Building Source Influence Zones of buildings to plume dispersion**



Stack-Building Preliminary\*  
 Stack Stack Base Elevation GEP\*\* GEP Stack  
 Name Height Differences EQN1 Height Value

S1	50.00	0.00	0.00	75.00	75.00
S2	50.00	0.00	0.00	75.00	75.00
GSSTACK	10.20	0.00	0.00	75.00	75.00

Results are based on Determinants 1 & 2 on pages 1 & 2 of the GEP Technical Support Document. Determinant 3 may be investigated for additional stack height credit. Final values result after Determinant 3 has been taken into consideration. \*\* Results were derived from Equation 1 on page 6 of GEP Technical Support Document. Values have been adjusted for any stack-building base elevation differences. Note: Criteria for determining stack heights for modeling emission limitations for a source can be found in Table 3.1 of the GEP Technical Support Document.

**Table 3: AERMOD BPIP**

**Building Downwash Information**

BPIP output is in meters

SO BUILDHGT S1	30	30	30	30	30	30
SO BUILDHGT S1	30	30	30	30	30	30
SO BUILDHGT S1	30	30	30	30	30	30
SO BUILDHGT S1	30	30	30	30	30	30
SO BUILDHGT S1	30	30	30	30	30	30
SO BUILDHGT S1	30	30	30	30	30	30
SO BUILDWID S1	351.19	381.98	412.65	430.78	435.82	427.53
SO BUILDWID S1	406.15	372.43	331.04	333.25	366.41	408.78
SO BUILDWID S1	438.74	455.36	458.15	447.02	422.31	384.76
SO BUILDWID S1	351.19	381.98	412.65	430.78	435.82	427.53
SO BUILDWID S1	406.15	372.43	331.04	333.25	366.41	408.78
SO BUILDWID S1	438.74	455.36	458.15	447.02	422.31	384.76
SO BUILDLEN S1	334.01	366.41	408.78	438.74	455.36	458.15
SO BUILDLEN S1	447.02	422.31	384.76	351.97	381.98	412.65
SO BUILDLEN S1	430.78	435.82	427.62	406.43	372.88	331.66
SO BUILDLEN S1	334.01	366.41	408.78	438.74	455.36	458.15
SO BUILDLEN S1	447.02	422.31	384.76	351.97	381.98	412.65
SO BUILDLEN S1	430.78	435.82	427.62	406.43	372.88	331.66
SO XBADJ S1	-233.2	-225.5	-232.06	-231.58	-224.05	-209.72
SO XBADJ S1	-189.02	-162.58	-131.19	-95.82	-89.99	-92.92
SO XBADJ S1	-93.02	-90.3	-84.83	-76.78	-66.41	-57.66
SO XBADJ S1	-100.82	-140.91	-176.72	-207.16	-231.31	-248.43
SO XBADJ S1	-258	-259.73	-253.57	-256.15	-291.99	-319.73
SO XBADJ S1	-337.76	-345.52	-342.79	-329.64	-306.48	-274
SO YBADJ S1	-79.78	-101	-113.41	-122.37	-127.61	-128.94
SO YBADJ S1	-126.29	-119.81	-107.86	-65.81	-42.29	-27.67
SO YBADJ S1	-12.21	3.63	19.35	34.49	48.58	61.19

SO YBADJ S1	79.78	101	113.41	122.37	127.61	128.94
SO YBADJ S1	126.29	119.81	107.86	65.81	42.29	27.67
SO YBADJ S1	12.21	-3.63	-19.35	-34.49	-48.58	-61.19
SO BUILDHGT S2	30	30	30	30	30	30
SO BUILDHGT S2	30	30	30	30	30	30
SO BUILDHGT S2	30	30	30	30	30	30
SO BUILDHGT S2	30	30	30	30	30	30
SO BUILDHGT S2	30	30	30	30	30	30
SO BUILDHGT S2	30	30	30	30	30	30
SO BUILDWID S2	351.19	381.98	412.65	430.78	435.82	427.53
SO BUILDWID S2	406.15	372.43	331.04	333.25	366.41	408.78
SO BUILDWID S2	438.74	455.36	458.15	447.02	422.31	384.76
SO BUILDWID S2	351.19	381.98	412.65	430.78	435.82	427.53
SO BUILDWID S2	406.15	372.43	331.04	333.25	366.41	408.78
SO BUILDWID S2	438.74	455.36	458.15	447.02	422.31	384.76
SO BUILDLN S2	334.01	366.41	408.78	438.74	455.36	458.15
SO BUILDLN S2	447.02	422.31	384.76	351.97	381.98	412.65
SO BUILDLN S2	430.78	435.82	427.62	406.43	372.88	331.66
SO BUILDLN S2	334.01	366.41	408.78	438.74	455.36	458.15
SO BUILDLN S2	447.02	422.31	384.76	351.97	381.98	412.65
SO BUILDLN S2	430.78	435.82	427.62	406.43	372.88	331.66
SO XBADJ S2	-234.41	-227.89	-235.56	-236.08	-229.42	-215.79
SO XBADJ S2	-195.6	-169.47	-138.19	-102.71	-96.57	-98.98
SO XBADJ S2	-98.38	-94.8	-88.33	-79.18	-67.62	-57.66
SO XBADJ S2	-99.6	-138.51	-173.22	-202.66	-225.95	-242.37
SO XBADJ S2	-251.42	-252.84	-246.57	-249.26	-285.41	-313.67
SO XBADJ S2	-332.4	-341.02	-339.29	-327.25	-305.26	-274
SO YBADJ S2	-72.88	-94.42	-107.34	-117.01	-123.11	-125.44
SO YBADJ S2	-123.9	-118.59	-107.86	-67.02	-44.69	-31.17
SO YBADJ S2	-16.71	-1.73	13.29	27.91	41.68	54.19
SO YBADJ S2	72.88	94.42	107.34	117.01	123.11	125.44
SO YBADJ S2	123.9	118.59	107.86	67.02	44.69	31.17
SO YBADJ S2	16.71	1.73	-13.29	-27.91	-41.68	-54.19
SO BUILDHGT GSSTACK	30	30	30	30	30	30
SO BUILDHGT GSSTACK	30	30	30	30	30	30
SO BUILDHGT GSSTACK	30	30	30	30	30	30
SO BUILDHGT GSSTACK	30	30	30	30	30	30
SO BUILDHGT GSSTACK	30	30	30	30	30	30
SO BUILDHGT GSSTACK	30	30	30	30	30	30
SO BUILDWID GSSTACK	351.19	381.98	412.65	430.78	435.82	427.53
SO BUILDWID GSSTACK	406.15	372.43	331.04	333.25	366.41	408.78
SO BUILDWID GSSTACK	438.74	455.36	458.15	447.02	422.31	384.76
SO BUILDWID GSSTACK	351.19	381.98	412.65	430.78	435.82	427.53
SO BUILDWID GSSTACK	406.15	372.43	331.04	333.25	366.41	408.78
SO BUILDWID GSSTACK	438.74	455.36	458.15	447.02	422.31	384.76
SO BUILDLN GSSTACK	334.01	366.41	408.78	438.74	455.36	458.15
SO BUILDLN GSSTACK	447.02	422.31	384.76	351.97	381.98	412.65
SO BUILDLN GSSTACK	430.78	435.82	427.62	406.43	372.88	331.66

SO BUILDLEN GSSTACK	334.01	366.41	408.78	438.74	455.36	458.15
SO BUILDLEN GSSTACK	447.02	422.31	384.76	351.97	381.98	412.65
SO BUILDLEN GSSTACK	430.78	435.82	427.62	406.43	372.88	331.66
SO XBADJ GSSTACK	-225.28	-220.93	-230.99	-234.03	-229.96	-218.9
SO XBADJ GSSTACK	-201.19	-177.36	-148.15	-114.44	-109.7	-113.12
SO XBADJ GSSTACK	-113.1	-109.65	-102.86	-92.95	-80.21	-68.69
SO XBADJ GSSTACK	-108.73	-145.47	-177.79	-204.71	-225.41	-239.26
SO XBADJ GSSTACK	-245.83	-244.94	-236.61	-237.54	-272.28	-299.53
SO XBADJ GSSTACK	-317.68	-326.17	-324.76	-313.48	-292.67	-262.97
SO YBADJ GSSTACK	-61.16	-81.29	-93.2	-102.29	-108.26	-110.91
SO YBADJ GSSTACK	-110.13	-106	-96.83	-57.89	-37.73	-26.6
SO YBADJ GSSTACK	-14.66	-2.27	10.18	22.32	33.79	44.23
SO YBADJ GSSTACK	61.16	81.29	93.2	102.29	108.26	110.91
SO YBADJ GSSTACK	110.13	106	96.83	57.89	37.73	26.6
SO YBADJ GSSTACK	14.66	2.27	-10.18	-22.32	-33.79	

#### 8.4 INPUT DATA IN THE DISPERSION MODEL (SOURCE PATHWAY)

The following parameters have been provided the ADM:

**Table 4: Input Data for AERMOD Model Run 2 X 250 T/YR MW WTE Boiler and 0.8 MW Diesel Generator set**

	Capacity	X	Y	Stack	Stack	VFR	Stack	Stack	Stack Ht.
APSE	T/day	Long	Lat	Temp. °C	Temp. (K)	(Ncm/sec)	Diam (m)	Area (m <sup>2</sup> )	(m)
Boiler 1	250	4.183004N;	73.437155 E	144	417	16.07	1.5	1.76715	50.00
Boiler 2	250			144	417	16.07	1.5	1.76715	50.00
Genset 1	0.8 MW	4.182394	73.43737	400	673	3.4638889	0.5	0.13	10.2

UTM Coordinates (Boiler): 326540.00 N 462472.00 E

UTM Coordinates (Generatorset): 326556.96N 462460.97 E

**Table 5: DESIGN EMISSION CONCENTRATION**

TD /TD	PM10	CO	N0x	SOx	Hg	HCl	Hf	NH3	DF
mg/Nm3									
5.00	0.50	50.00	150.00	50.00	0.03	10.00	1.00	10.00	0.10
5.00	0.50	50.00	150.00	50.00	0.03	10.00	1.00	10.00	0.10
79.95	nd	300	319.968	nd	nd	nd	nd	nd	nd

**Table 6: DESIGN EMISSION STRENGTH**

TD /TD	PM10	CO	N0x	SOx	Hg	HCL	Hf	NH3	DF
g/sec									
0.0804	0.0080	0.8036	2.4107	0.8036	0.0005	0.1607	0.0161	0.1607	0.0016
0.0804	0.0080	0.8036	2.4107	0.8036	0.0005	0.1607	0.0161	0.1607	0.0016
0.2769	nd	1.0392	1.1083	nd	nd	nd	nd	nd	nd

## 9. RESULTS OF DISPERSION MODEL RUN

Dispersion model results are presented according to rankings of peak values of ground level concentrations. Below are summary of results for highest GLCs for the Partidulates, Metals and Gaseous Emissions. Results are presented within the 4 km by 4 km dimension graphical presentation Distance (X axis) and Concentration ug/Ncm (Y Axis). Maximum straight line domain is 4000 m (4 km). Raw data of model results are in output files following Nomenclatures : (x=distance from source, km), conc=ground-level centerline concentration, ug/m<sup>3</sup>), (sigmay=dispersion coefficient in Y direction, dimensionless) , (sigmaz=dispersion coefficient in Z direction, dimensionless), (xf=distance to final plume rise, km) , (h=plume height, m). See Table 7 Figures 24 to 48.

**Table 7: Summary Maximum Ground Level Concentration - AERMOD**

MAXIMUM GROUND LEVEL CONCENTRATION						German Standards (TA Luft)		USEPA	WHO Air Quality Guidelines	% of the Applicable Standards
Parameters	Ave. Time	Conc (ug/Nm <sup>3</sup> )	Deposition (g/m <sup>2</sup> )	X	Y	Conc (ug/Nm <sup>3</sup> )	Deposition (g/m <sup>2</sup> )	Conc (ug/Nm <sup>3</sup> )	Conc (ug/Nm <sup>3</sup> )	%
Total Dust	1 hour	7.60628	0.00754	327040	462672	-	-	-	-	-
Total Dust	24 hour	3.18863	0.03805	327140	462572	-	-	-	-	-
Total Dust	1 year	0.34134	0.43994	326840	462572	-	0.35	-	-	-
PM10	1 hour	0.10288	0.00037	326640	462472	-	-	-	20	0.51
PM10	24 hour	0.02844	0.00078	326640	462472	50	-	150	50	0.06
PM10	1 year	0.0025	0.02508	327240	462572	40	-	50	20	0.01
SO2	1 hour	10.3398	-	326640	462472	350	-	212	-	4.88
SO2	24 hour	2.85793	-	326640	462472	125	-	365	20	14.29
SO2	1 year	0.25302	-	327240	462572	50	-	79	-	0.32
NO2(NOx)	1 hour	48.91013	-	326640	462472	200	-	100 ppb	200	24.46
NO2(NOx)	24 hour	14.16085	-	326640	462472	-	-	-	-	-
NO2(NOx)	1 year	2.1	-	324540	460472	40	-	53 ppb	40	5.25
Hg	1 hour	0.00643	-	326640	462472	-	-	-	-	-
Hg	24 hour	0.00178	-	326640	462472	-	1	-	-	-
Hg	1 year	0.00157	-	327240	462572	-	0.05	-	-	-
NH3	1 hour	2.06667	-	326640	462472	-	-	-	-	-
NH3	24 hour	0.57123	-	326640	462472	-	-	-	-	-
NH3	1 year	0.00147	-	326340	461872	-	-	-	-	-
HCl	1 hour	2.06667	-	326540	462472	-	-	-	-	-
HCl	24 hour	0.57123	-	326540	462472	-	-	-	-	-
HCl	1 year	0.00147	-	324540	460472	-	-	-	-	-
Hf	1 hour	0.20705	-	326640	462472	-	-	-	-	-
Hf	24 hour	0.05723	-	326640	462472	-	-	-	-	-



MAXIMUM GROUND LEVEL CONCENTRATION						German Standards (TA Luft)		USEPA	WHO Air Quality Guidelines	% of the Applicable Standards
Hf	1 year	0.00015	-	324540	460472	-	-	-	-	-
D/F	1 hour	0.02058	-	326640	462472	-	-	-	-	-
D/F	24 hour	0.00569	-	326640	462472	-	-	-	-	-
D/F	1 year	0.00002	-	324540	460472	-	-	-	-	-
Sum of Metals (Sb) <sup>1</sup>	1 hour	1.31607	-	326440	462172	-	-	-	-	-
Sum of Metals (Sb) <sup>1</sup>	24 hour	0.49540	-	326440	462572	-	-	-	-	-
Sum of Metals (Sb) <sup>1</sup>	1 year	0.09818	-	326440	462472	-	-	-	-	-
Sum of Metals (As) <sup>2</sup>	1 hour	0.13161	-	326440	462172	-	-	-	-	-
Sum of Metals (As) <sup>2</sup>	24 hour	0.04954	-	326440	462572	-	-	-	-	-
Sum of Metals (As) <sup>2</sup>	1 year	0.00982	-	326440	462472	-	-	-	-	-
Sum of Metals (Tl) <sup>3</sup>	1 hour	0.13161	-	326440	462172	-	-	-	-	-
Sum of Metals (Tl) <sup>3</sup>	24 hour	0.04954	-	326440	462572	-	-	-	-	-
Sum of Metals (Tl) <sup>3</sup>	1 year	0.00982	-	326440	462472	-	-	-	-	-

<sup>1</sup>Sum of metals: Antimony, Chromium, Copper, Manganese, Vanadium, in, Lead, Cobalt, Nickel

<sup>2</sup>Sum of metals: Arsenic / cadmium and its compounds (expressed as As and Cd), benzo (a) pyrene, water-soluble cobalt compounds (expressed as Co), chromium (VI) compounds (expressed as Cr)

<sup>3</sup>Sum of metals: Thallium and its compounds and cadmium



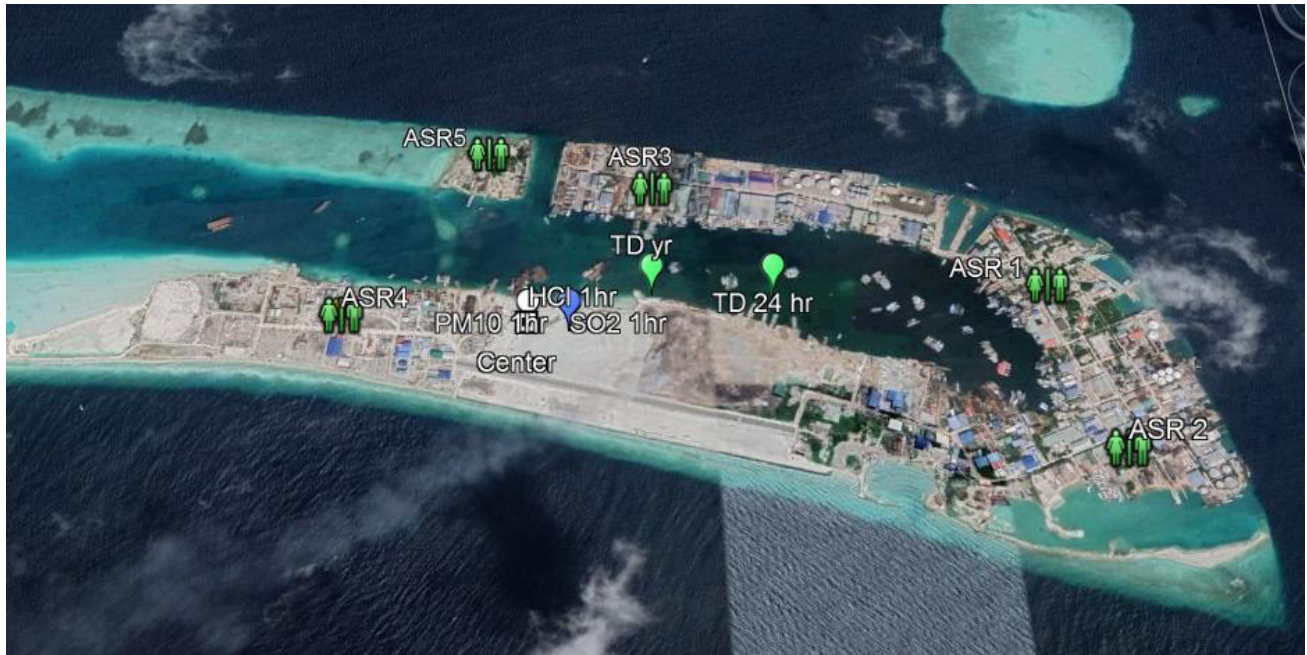
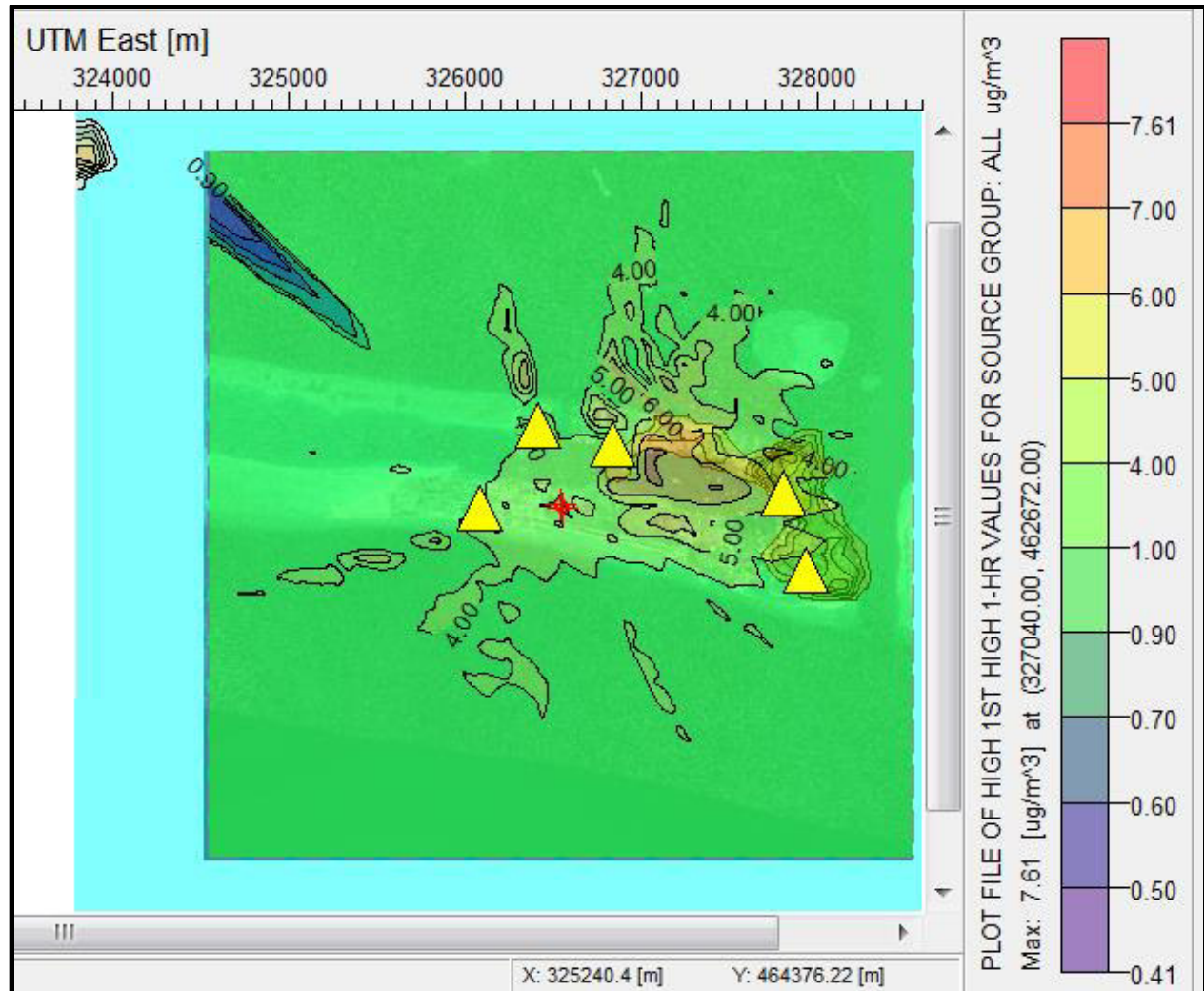


Figure 24: Location of Maximum Predicted Ground Level Concentration



**Figure 25: Total Dust (TD) (1 HR) (Isoleth in microgram/m<sup>3</sup>)**

LEGEND: Yellow Triangles refer to identified ASRs  
 Area Sensitive Receptor (ASRs)

	Long	Lat
ASR1	327812	462536
ASR2	327938	462105
ASR3	326839	462822
ASR4	326087	462455
ASR5	326416	462929

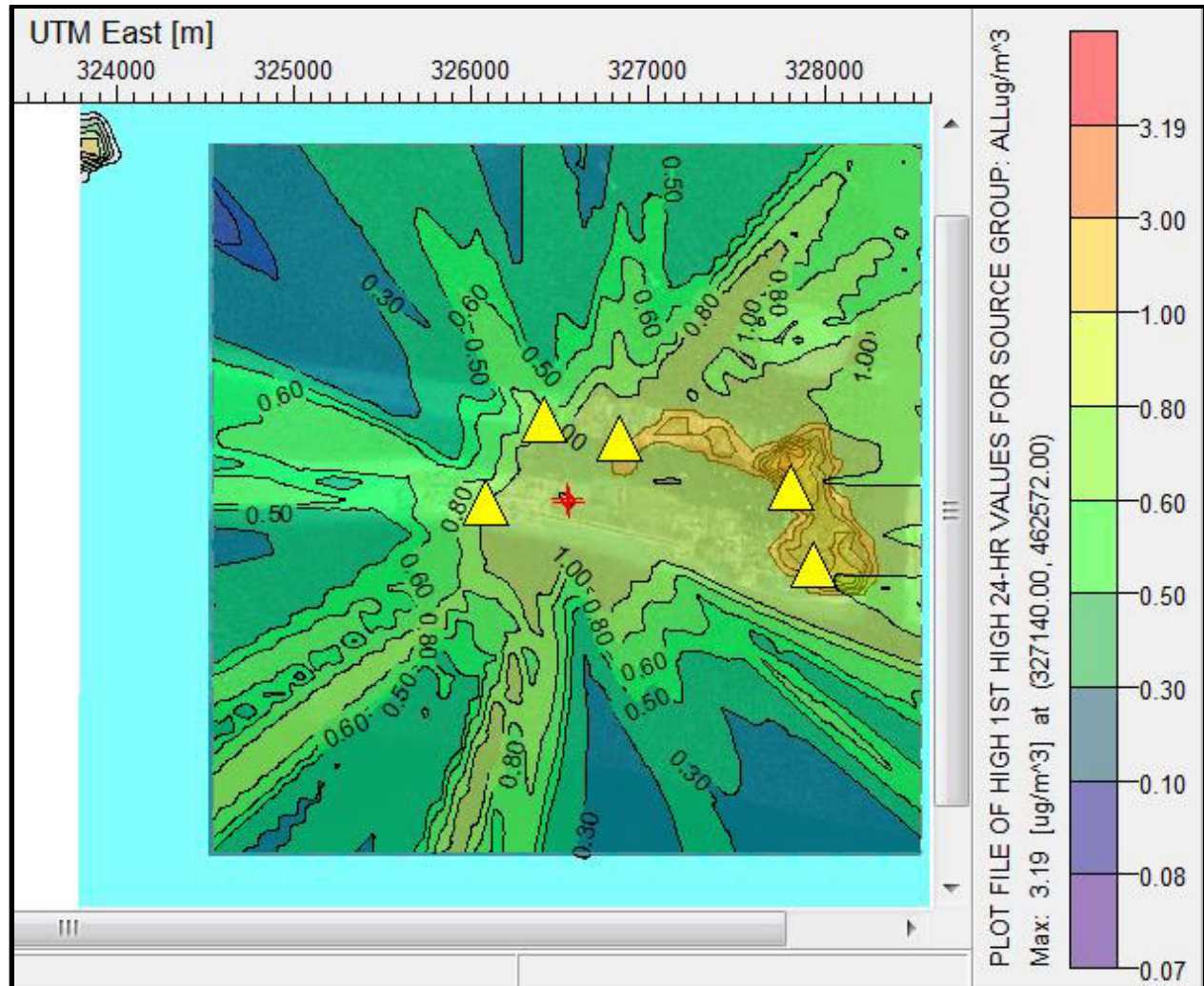


Figure 26: TD (24 HR) ( 1-HR RUN) (Isopleth in microgram/m3)

LEGEND: Yellow Triangles refer to identified ASRs  
 Area Sensitive Receptor (ASRs)

	Long	Lat
ASR1	327812	462536
ASR2	327938	462105
ASR3	326839	462822
ASR4	326087	462455
ASR5	326416	462929

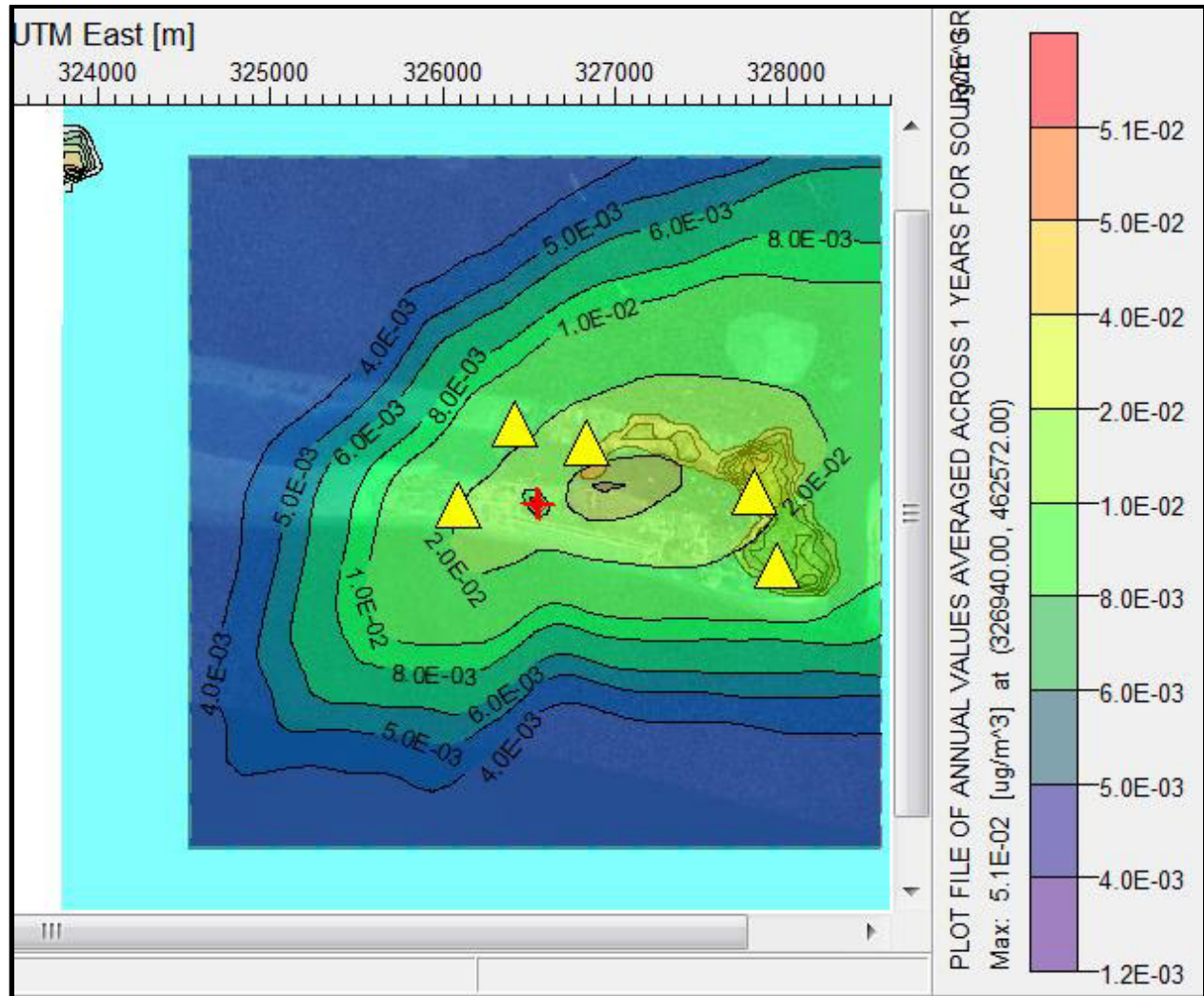


Figure 27: Total Dust 1YR (Isopleth in microgram/m<sup>3</sup>)

LEGEND: Yellow Triangles refer to identified ASRs  
 Area Sensitive Receptor (ASRs)

	Long	Lat
ASR1	327812	462536
ASR2	327938	462105
ASR3	326839	462822
ASR4	326087	462455
ASR5	326416	462929

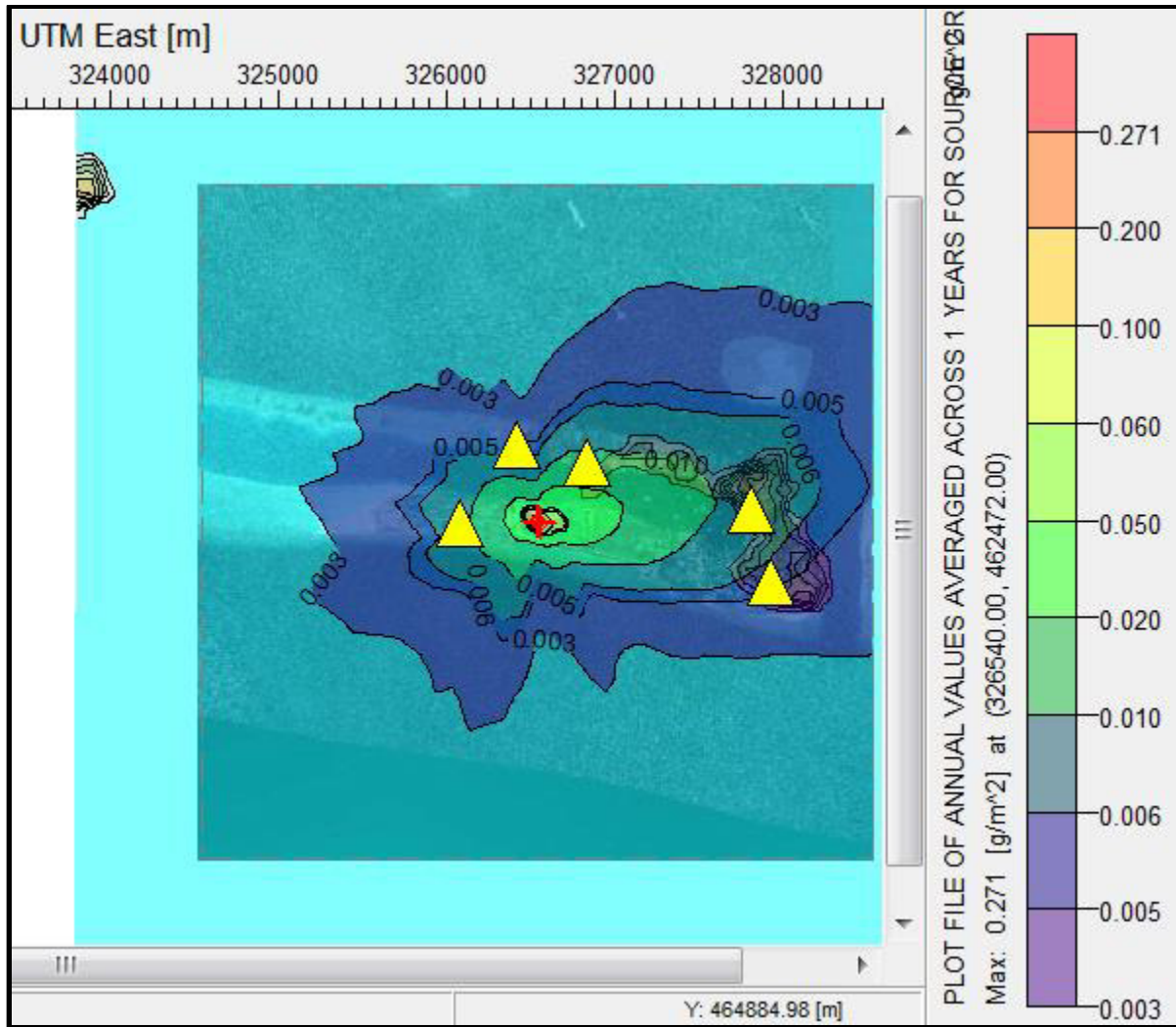


Figure 28: Total Dust 1YR Deposition (Isopleth in microgram/m3)

LEGEND: Yellow Triangles refer to identified ASRs  
 Area Sensitive Receptor (ASRs)

	Long	Lat
ASR1	327812	462536
ASR2	327938	462105
ASR3	326839	462822
ASR4	326087	462455
ASR5	326416	462929

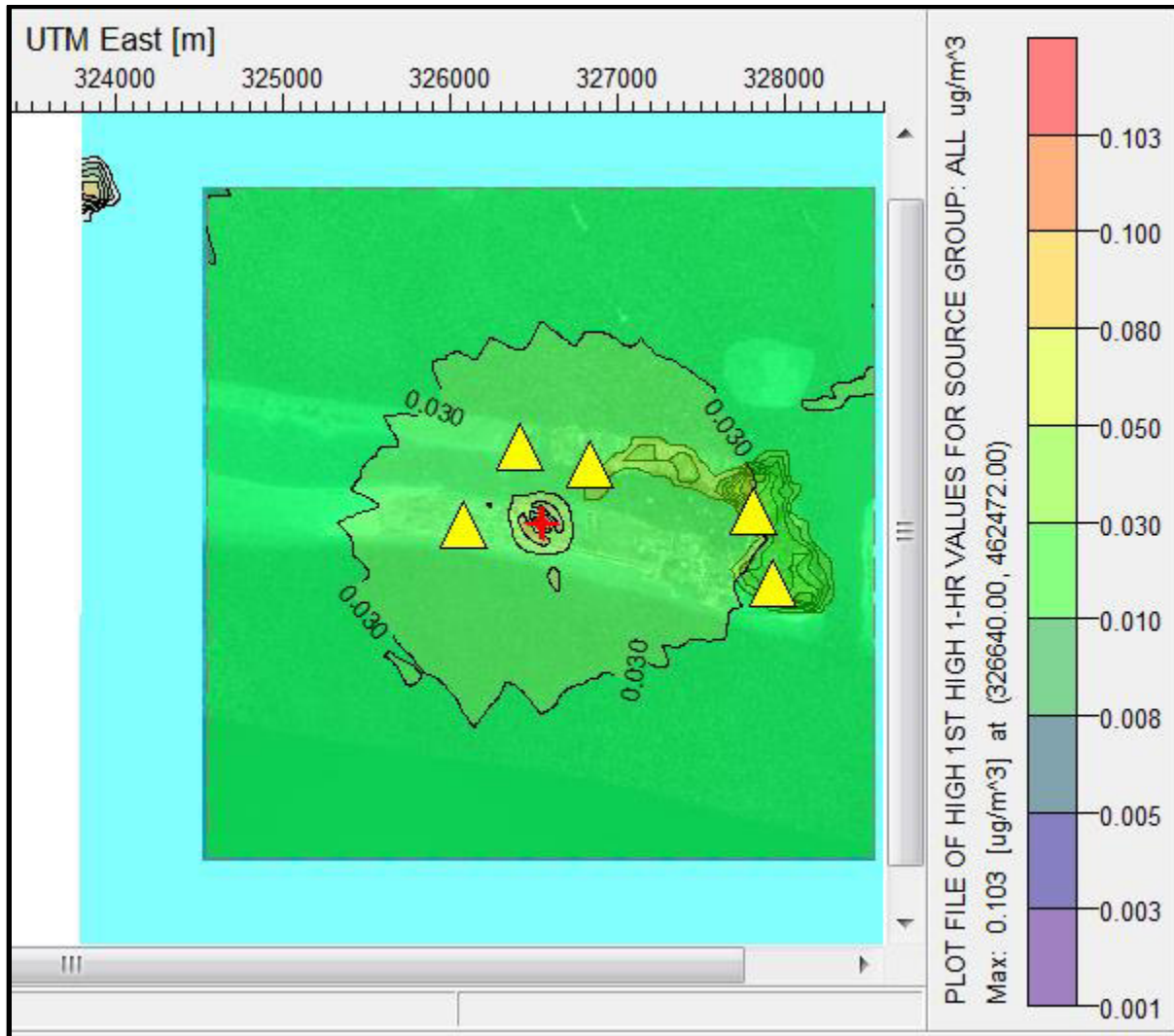


Figure 29: PM10 1 HR (Isopleth in microgram/m3)

LEGEND: Yellow Triangles refer to identified ASRs  
 Area Sensitive Receptor (ASRs)

	Long	Lat
ASR1	327812	462536
ASR2	327938	462105
ASR3	326839	462822
ASR4	326087	462455
ASR5	326416	462929



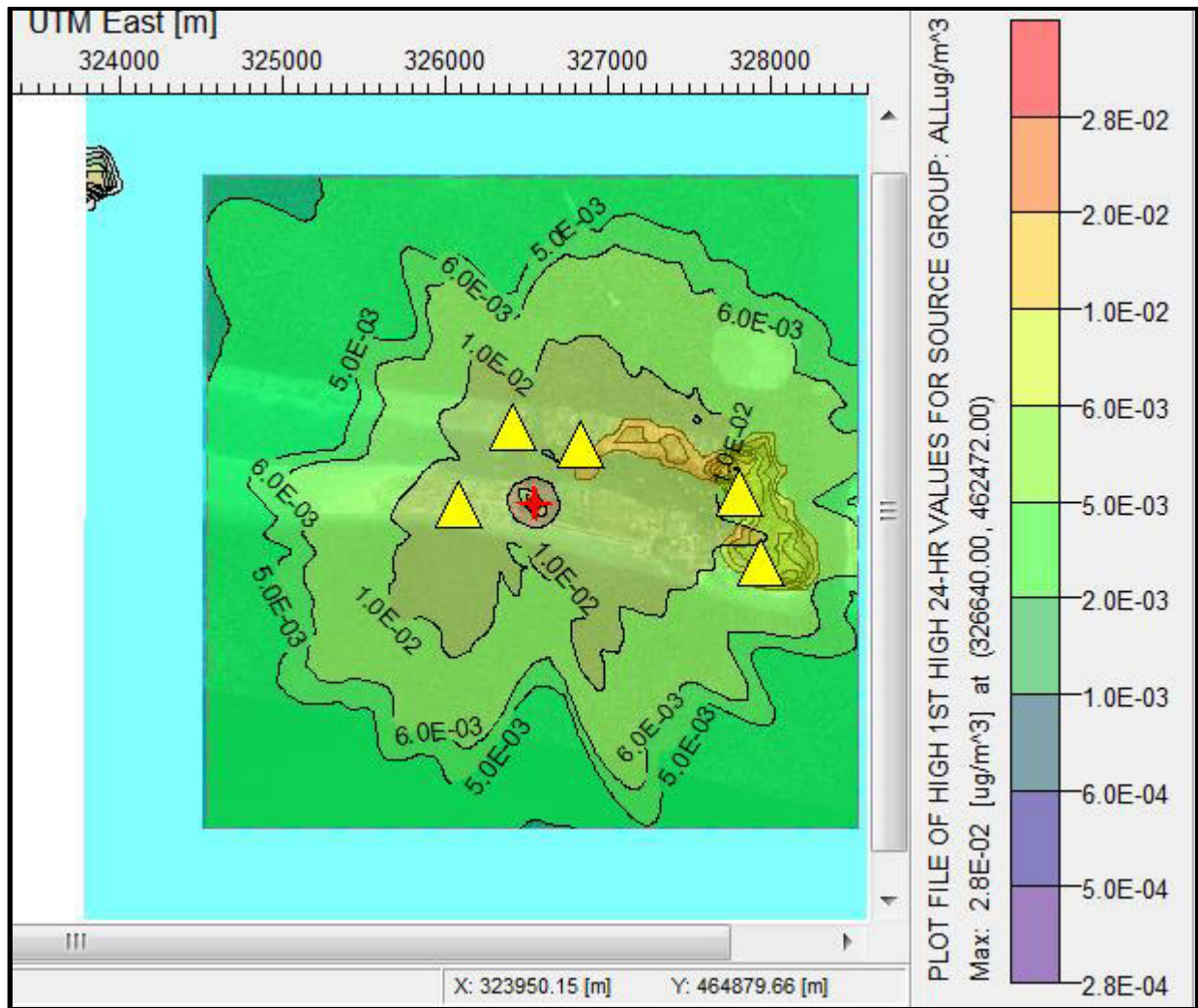


Figure 30: PM10 24 HR (Isopleth in microgram/m3)

LEGEND: Yellow Triangles refer to identified ASRs  
 Area Sensitive Receptor (ASRs)

	Long	Lat
ASR1	327812	462536
ASR2	327938	462105
ASR3	326839	462822
ASR4	326087	462455
ASR5	326416	462929

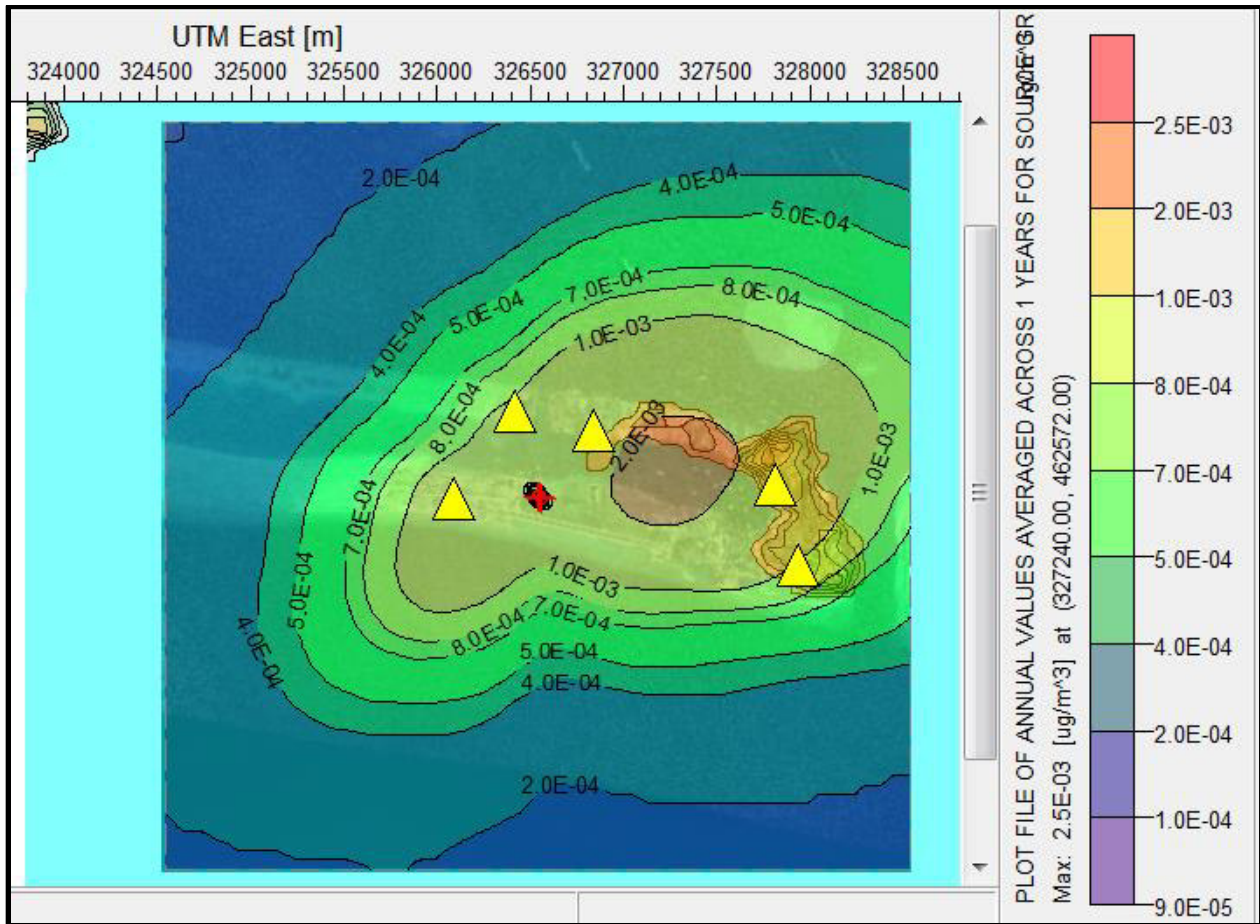


Figure 31: PM10 1 YR DEPOSITION (Isopleth in microgram/m3)

LEGEND: Yellow Triangles refer to identified ASRs  
 Area Sensitive Receptor (ASRs)

	Long	Lat
ASR1	327812	462536
ASR2	327938	462105
ASR3	326839	462822
ASR4	326087	462455
ASR5	326416	462929

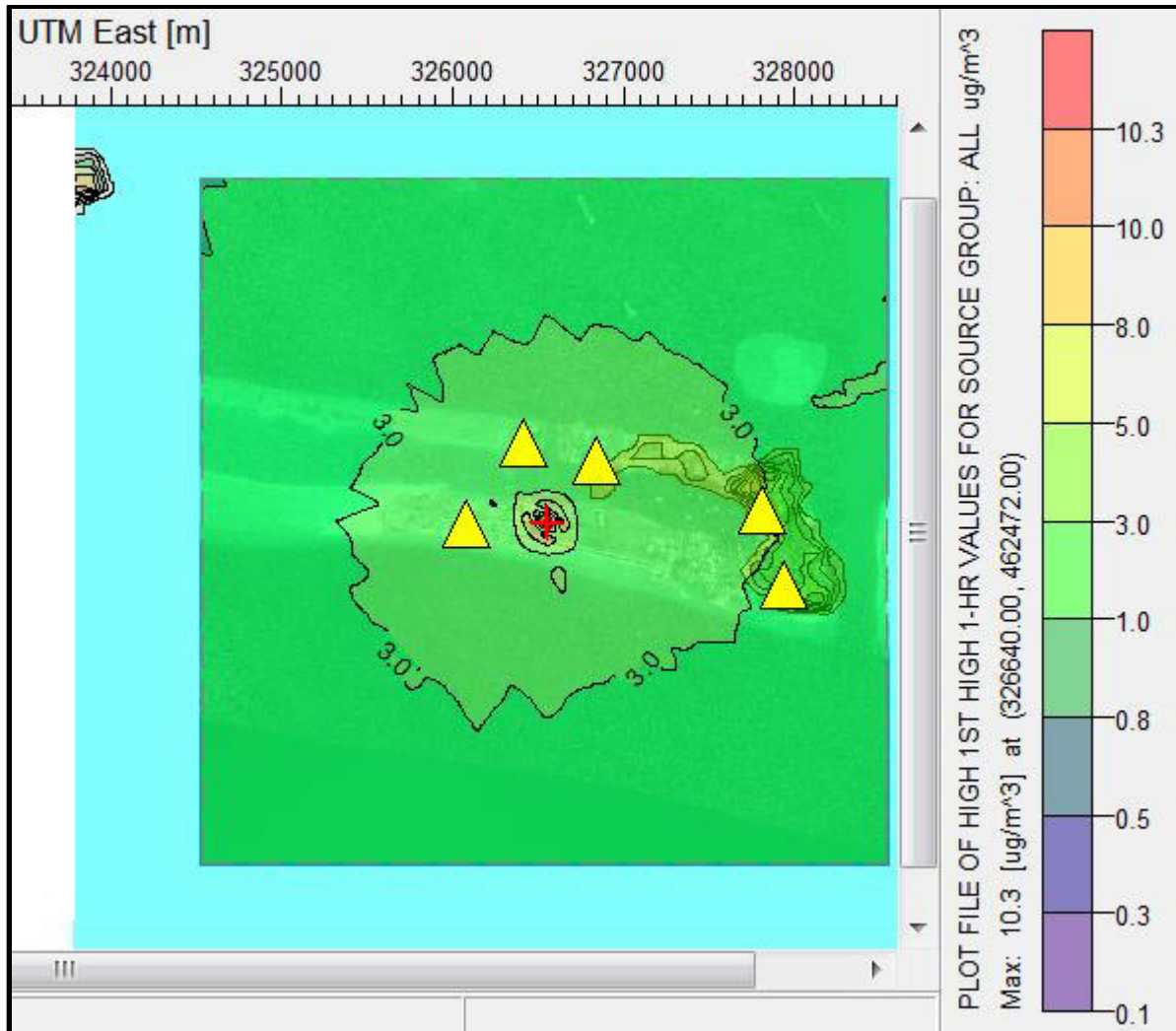


Figure 32: SO2 1 HR (Isopleth in microgram/m3)

LEGEND: Yellow Triangles refer to identified ASRs  
 Area Sensitive Receptor (ASRs)

	Long	Lat
ASR1	327812	462536
ASR2	327938	462105
ASR3	326839	462822
ASR4	326087	462455
ASR5	326416	462929

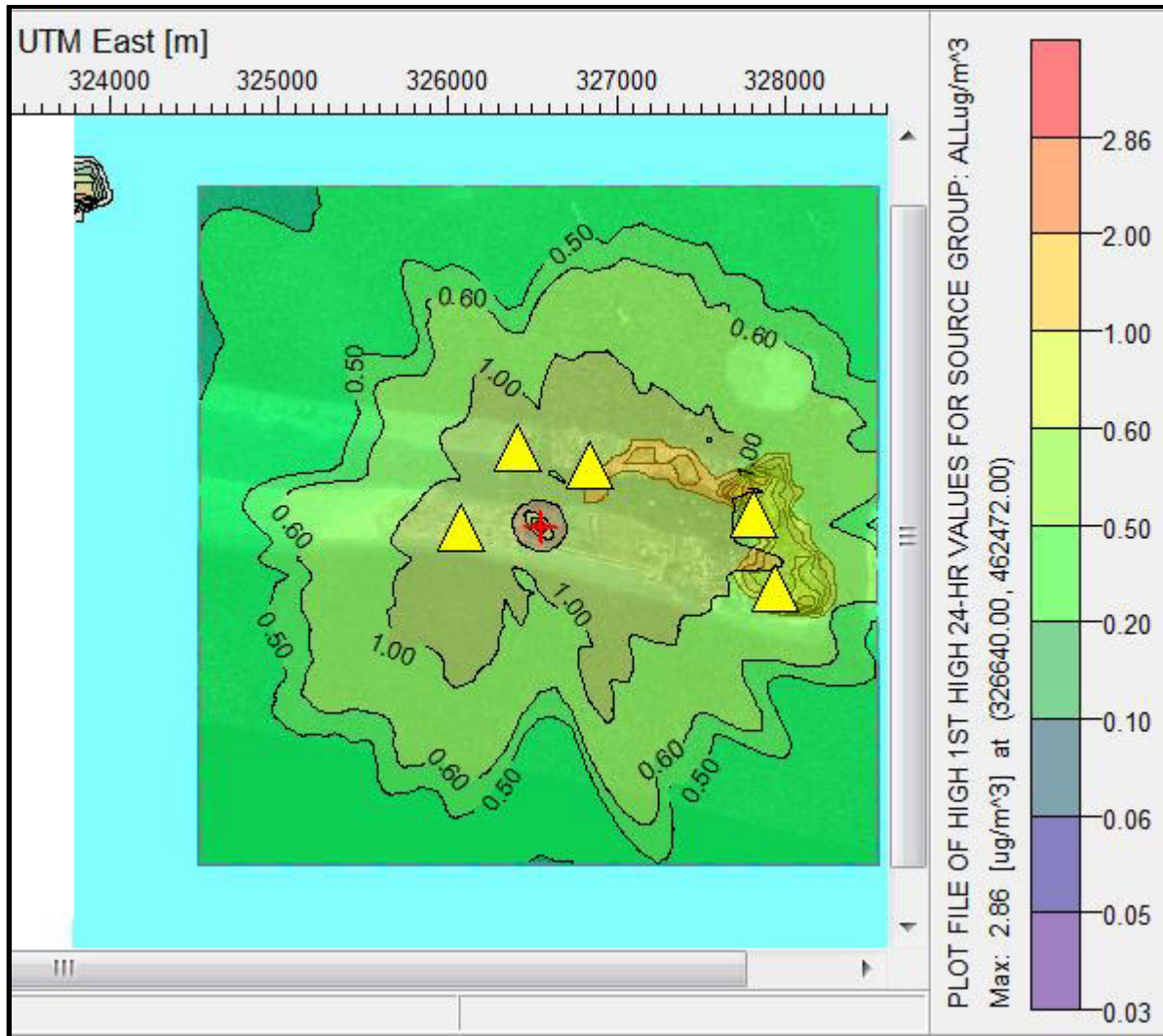


Figure 33: SO<sub>2</sub> 24 HR (Isopleth in microgram/m<sup>3</sup>)

LEGEND: Yellow Triangles refer to identified ASRs  
 Area Sensitive Receptor (ASRs)

	Long	Lat
ASR1	327812	462536
ASR2	327938	462105
ASR3	326839	462822
ASR4	326087	462455
ASR5	326416	462929

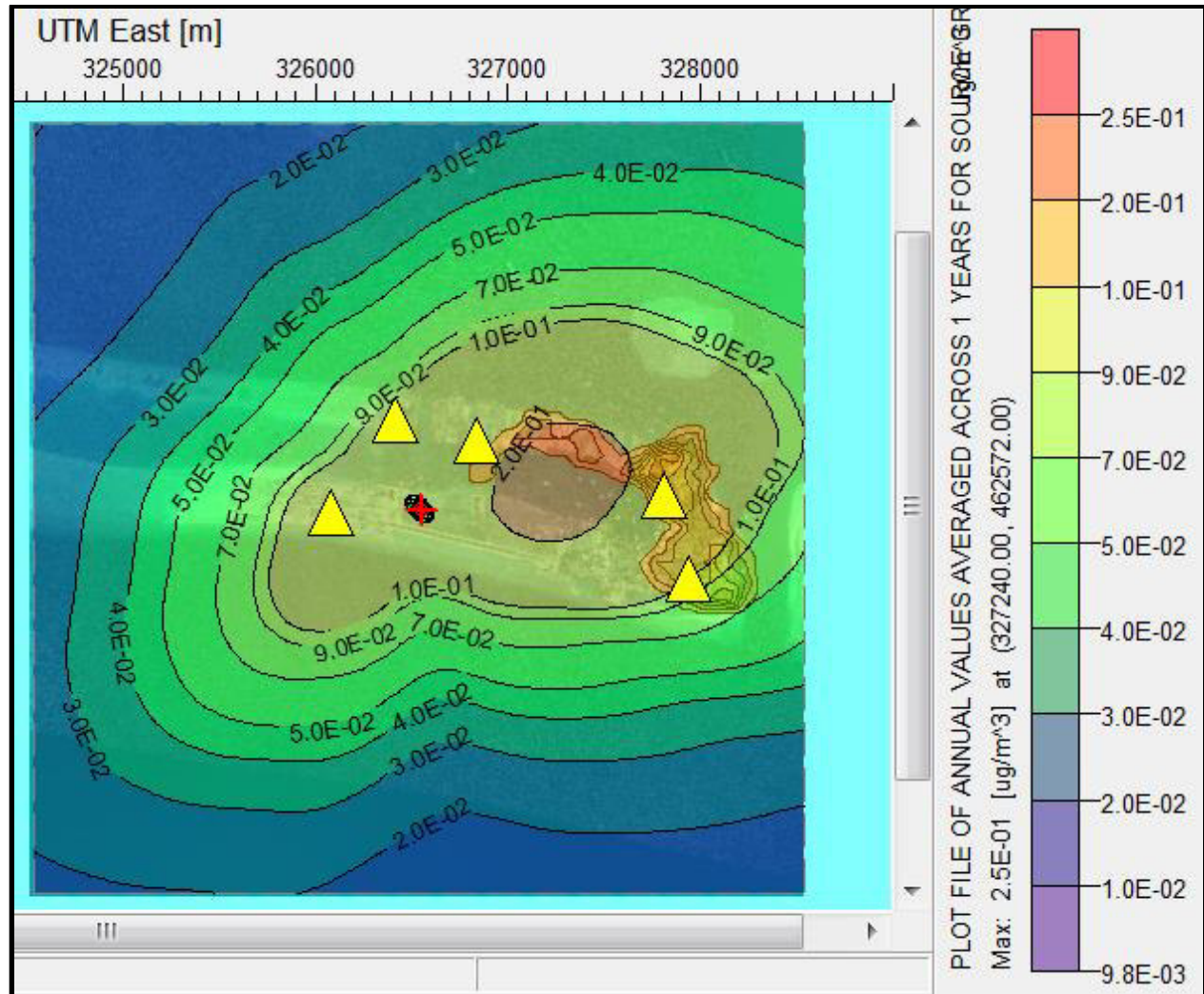


Figure 34: SO2 1 YR (Isopleth in microgram/m3)

LEGEND: Yellow Triangles refer to identified ASRs  
 Area Sensitive Receptor (ASRs)

	Long	Lat
ASR1	327812	462536
ASR2	327938	462105
ASR3	326839	462822
ASR4	326087	462455
ASR5	326416	462929

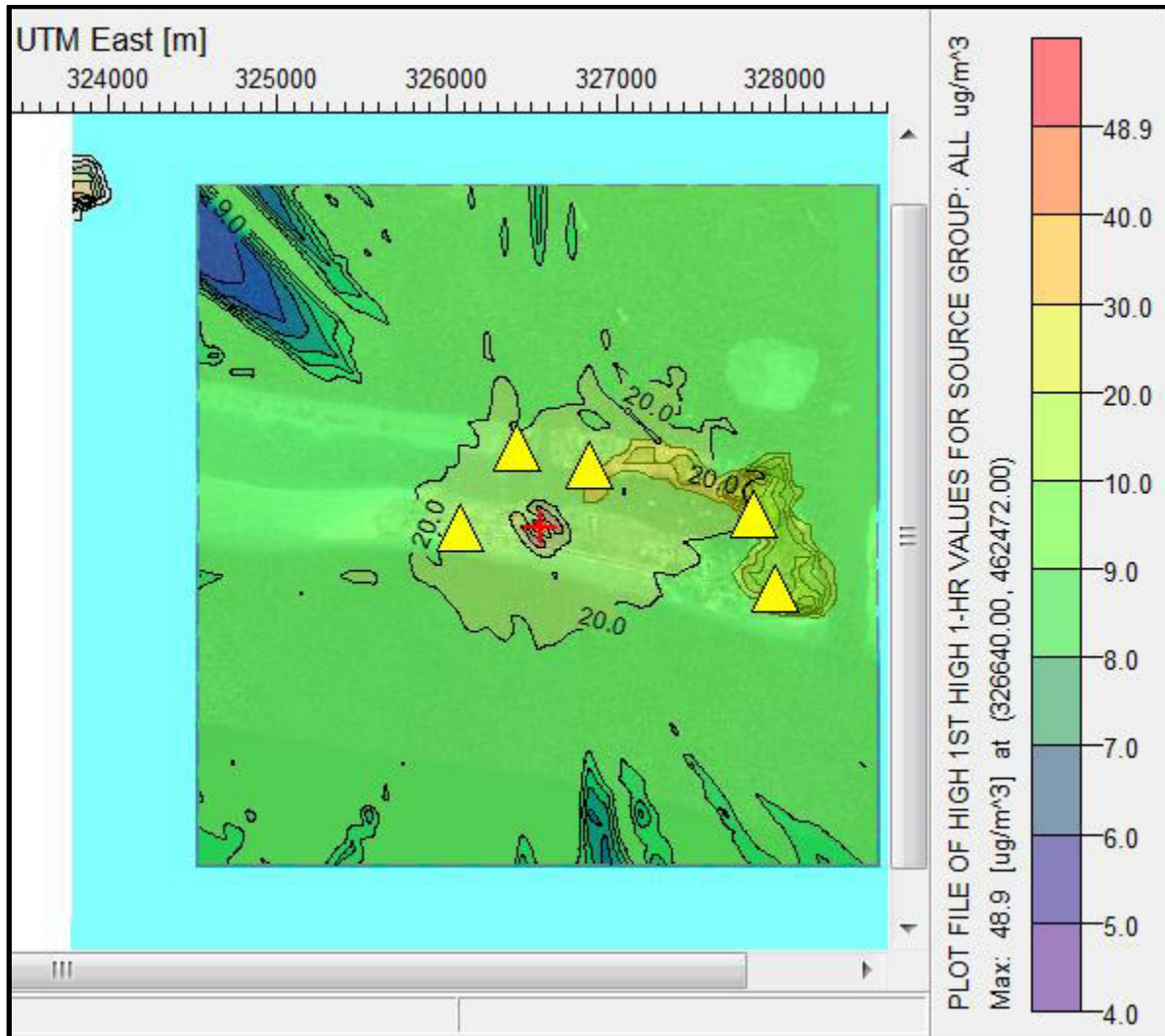


Figure 35: NO2 1 HR (Isopleth in microgram/m<sup>3</sup>)

LEGEND: Yellow Triangles refer to identified ASRs  
 Area Sensitive Receptor (ASRs)

	Long	Lat
ASR1	327812	462536
ASR2	327938	462105
ASR3	326839	462822
ASR4	326087	462455
ASR5	326416	462929

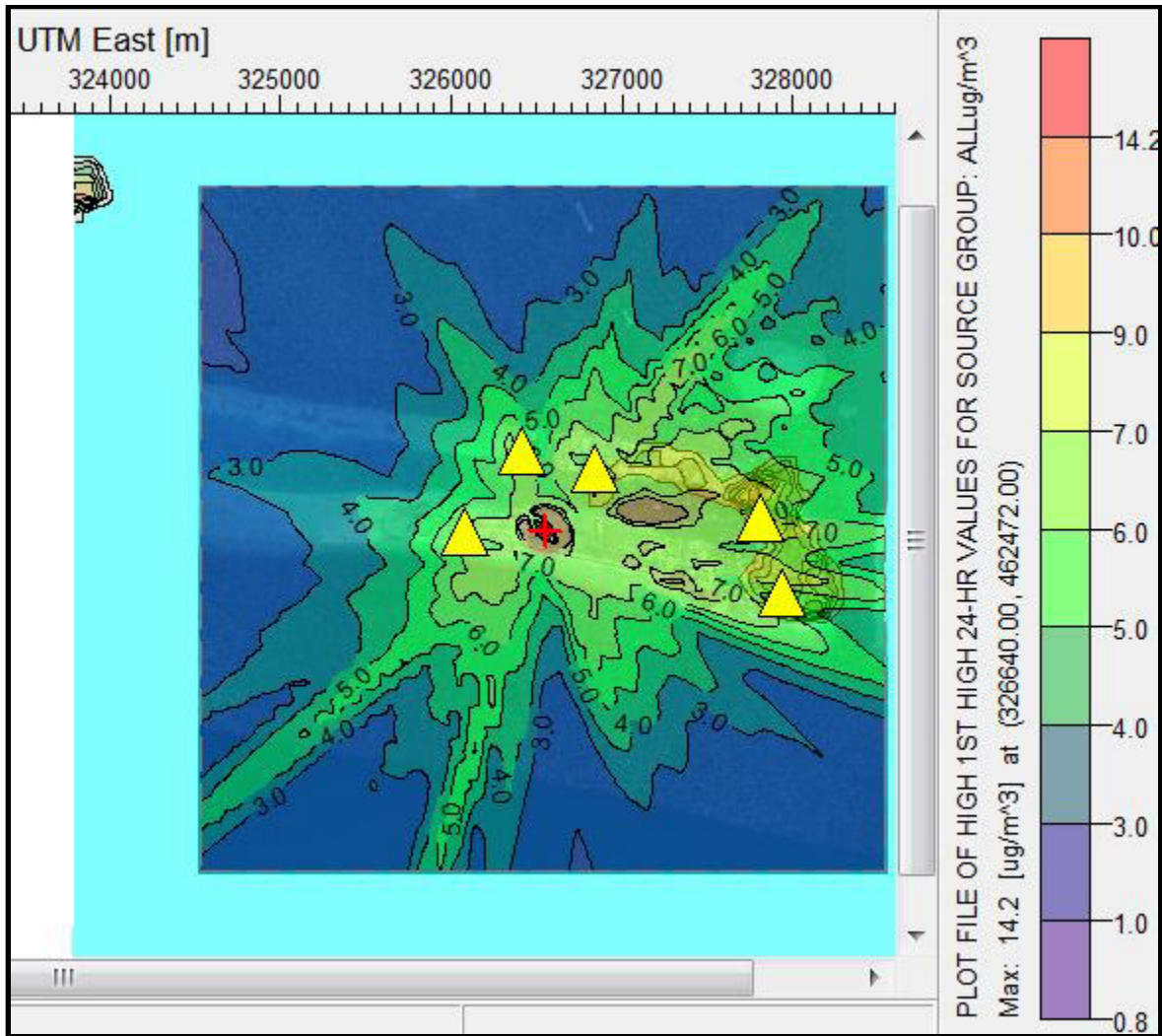
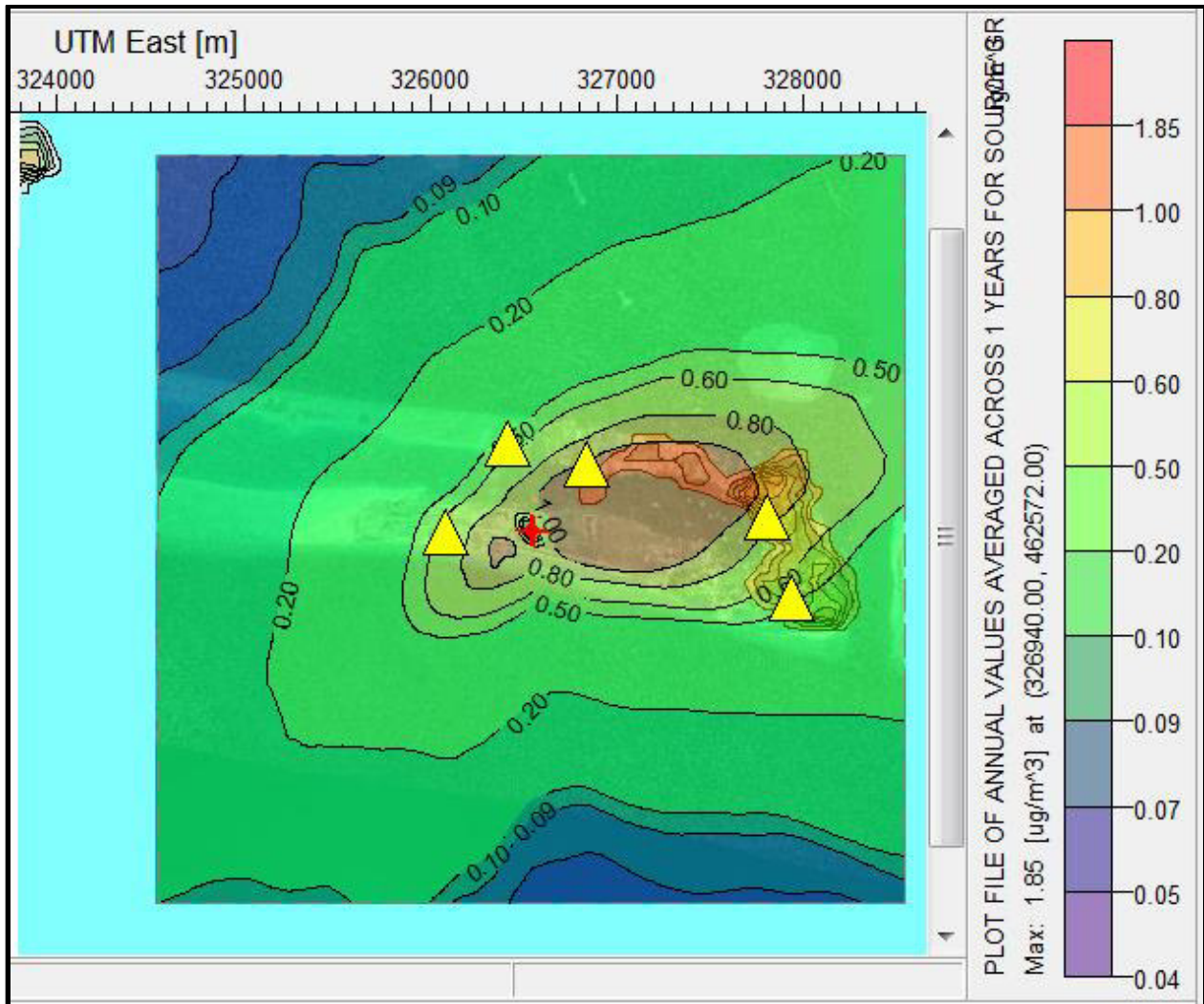


Figure 36: NO2 24 HR (Isopleth in microgram/m3)

LEGEND: Yellow Triangles refer to identified ASRs  
 Area Sensitive Receptor (ASRs)

	Long	Lat
ASR1	327812	462536
ASR2	327938	462105
ASR3	326839	462822
ASR4	326087	462455
ASR5	326416	462929



**Figure 37: NO2 1 YR HR (Isopleth in microgram/m<sup>3</sup>)**

LEGEND: Yellow Triangles refer to identified ASRs  
 Area Sensitive Receptor (ASRs)

	Long	Lat
ASR1	327812	462536
ASR2	327938	462105
ASR3	326839	462822
ASR4	326087	462455
ASR5	326416	462929



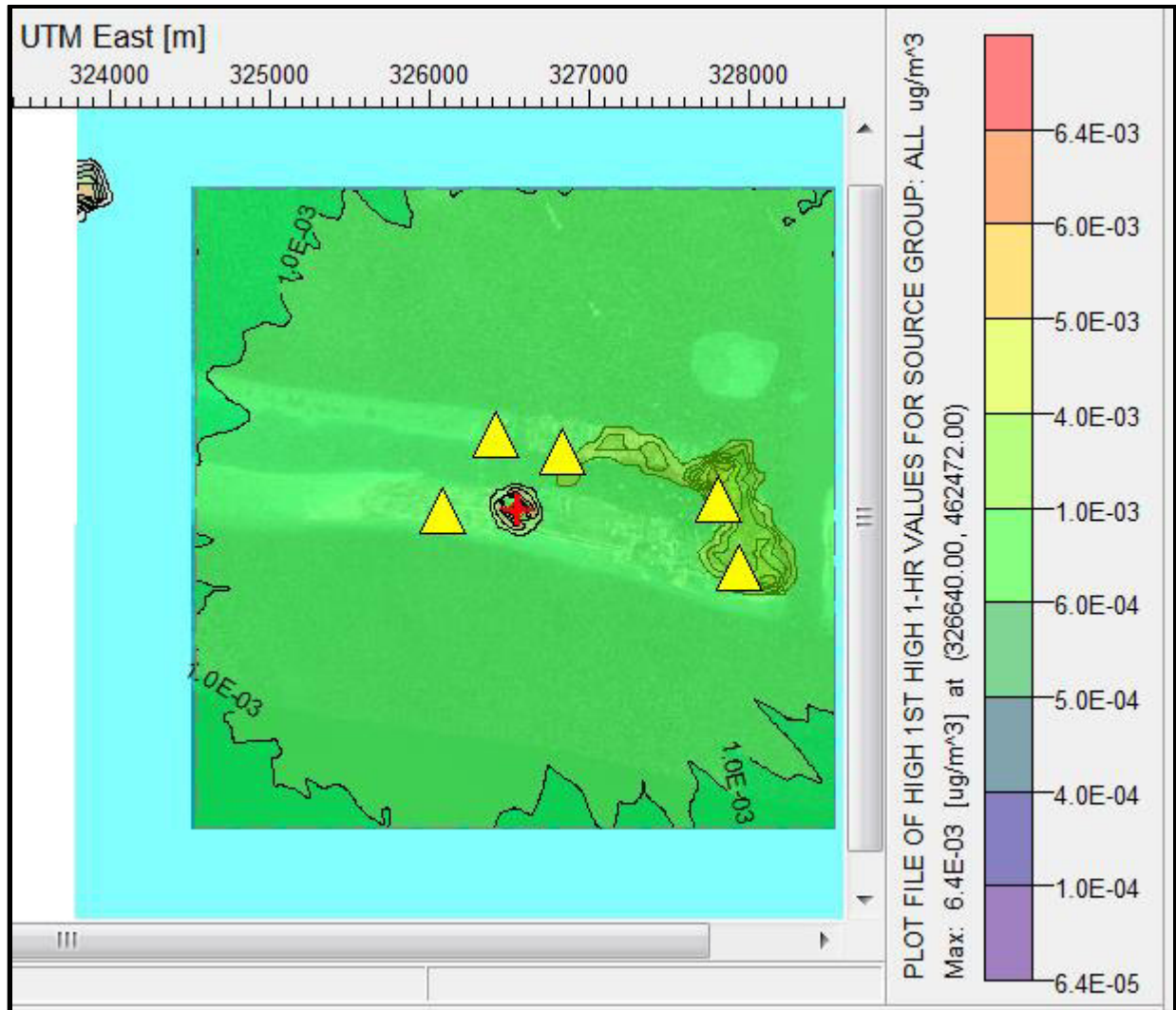
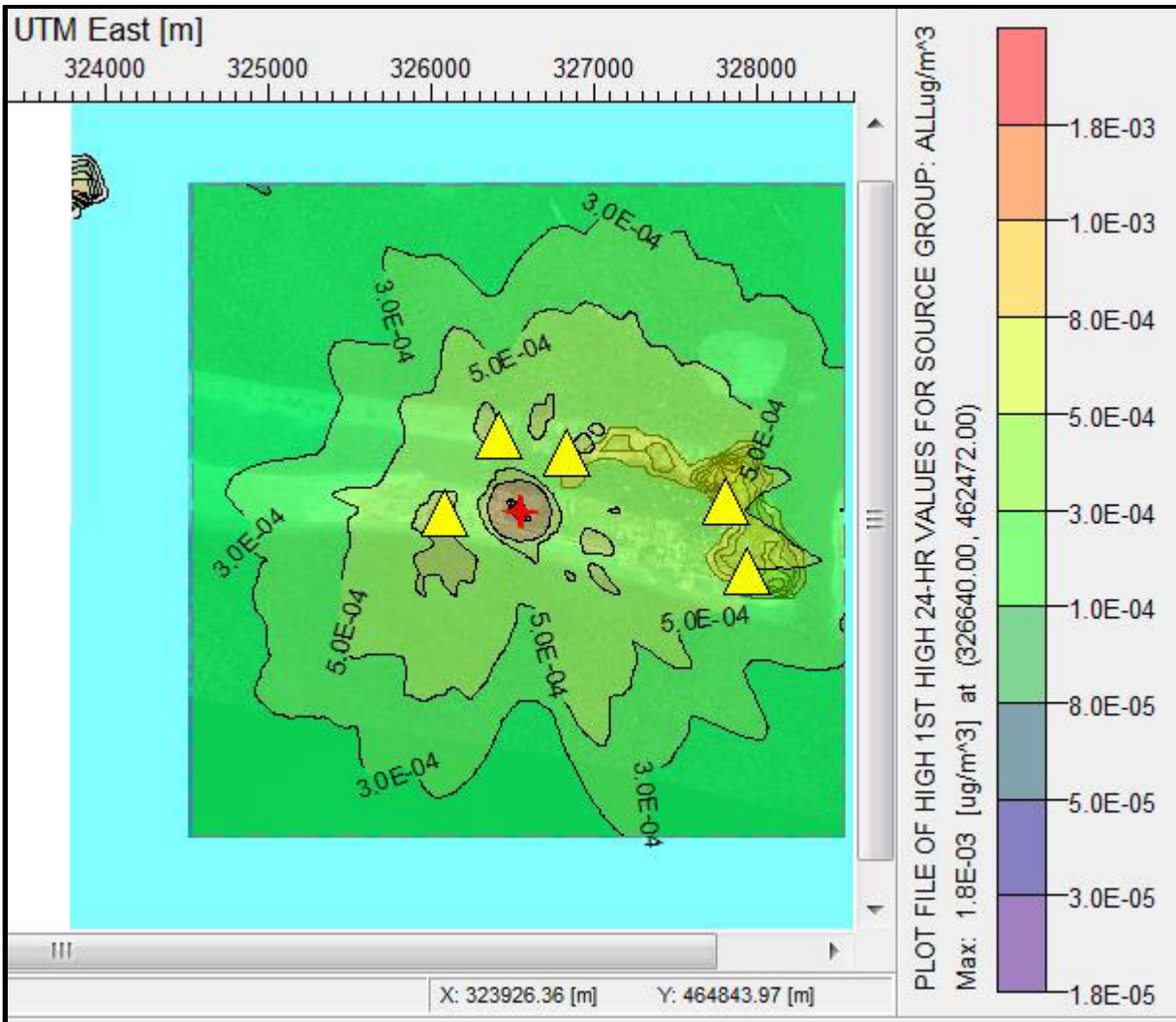


Figure 38: Hg 1 HR (Isopleth in microgram/m<sup>3</sup>)

LEGEND: Yellow Triangles refer to identified ASRs  
 Area Sensitive Receptor (ASRs)

	Long	Lat
ASR1	327812	462536
ASR2	327938	462105
ASR3	326839	462822
ASR4	326087	462455
ASR5	326416	462929



**Figure 39: Hg 24 HR (Isopleth in microgram/m3)**

LEGEND: Yellow Triangles refer to identified ASRs  
 Area Sensitive Receptor (ASRs)

	Long	Lat
ASR1	327812	462536
ASR2	327938	462105
ASR3	326839	462822
ASR4	326087	462455
ASR5	326416	462929

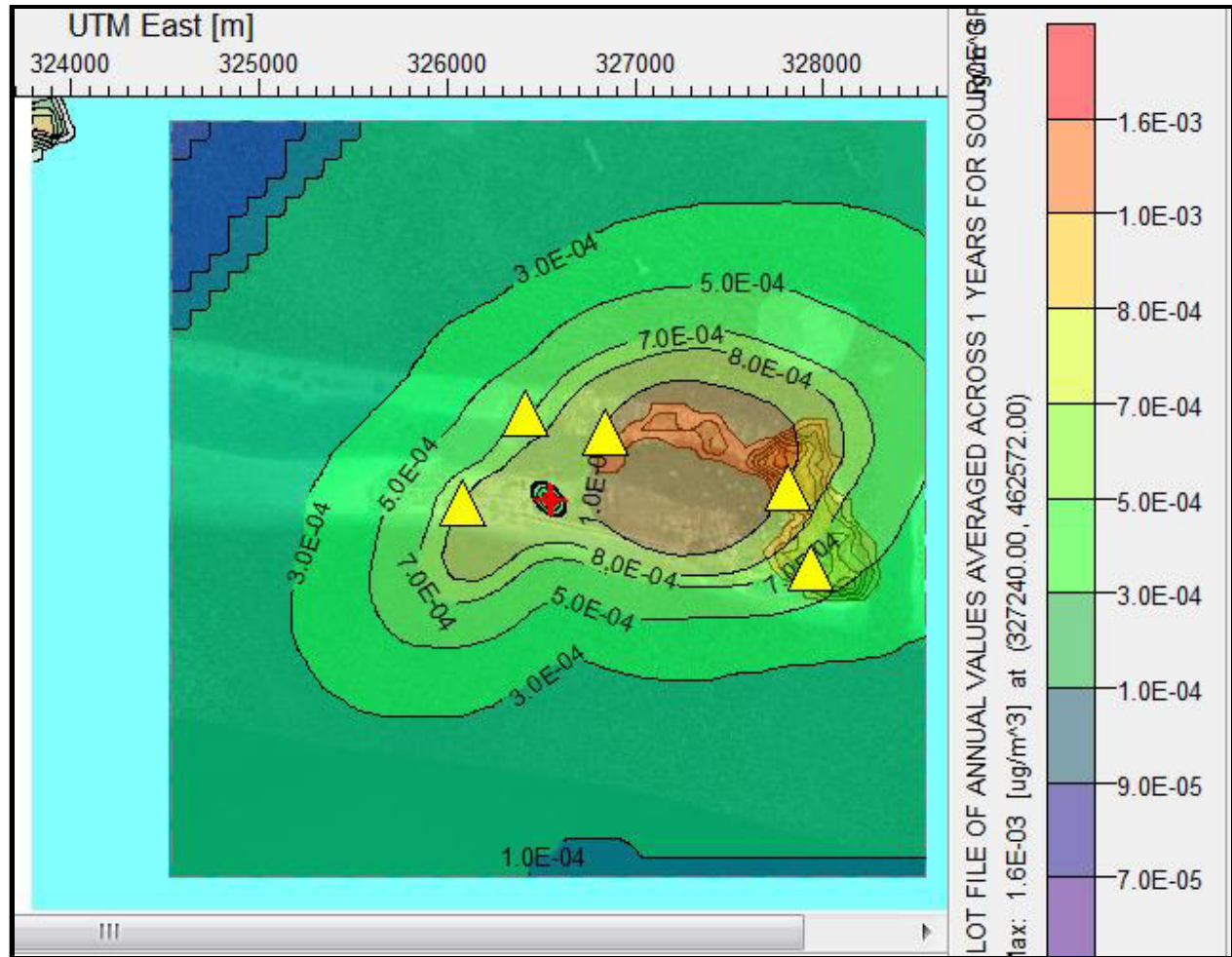
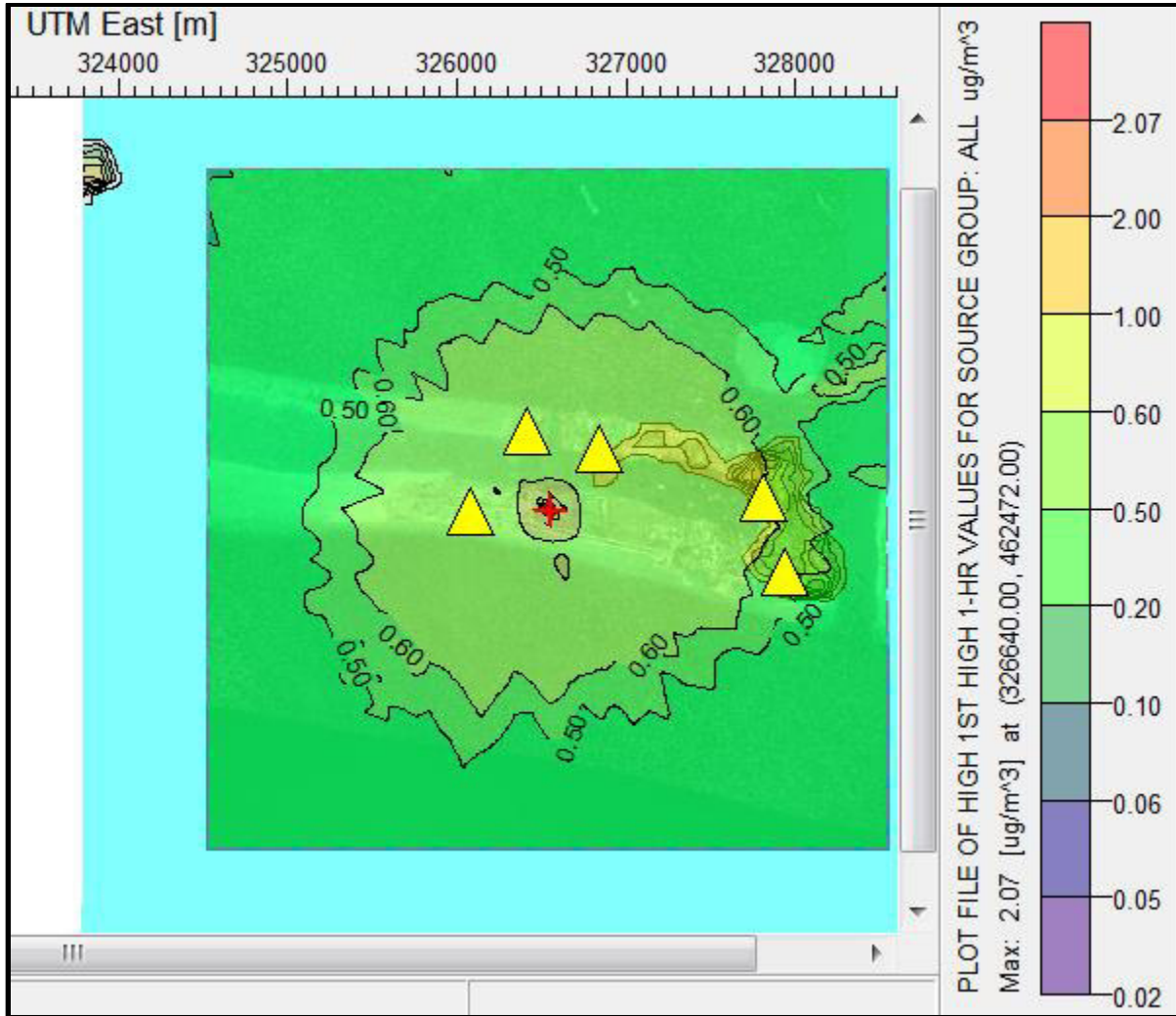


Figure 40: Hg 1 year (Isopleth in microgram/m3)

LEGEND: Yellow Triangles refer to identified ASRs  
 Area Sensitive Receptor (ASRs)

	Long	Lat
ASR1	327812	462536
ASR2	327938	462105
ASR3	326839	462822
ASR4	326087	462455
ASR5	326416	462929



**Figure 41: NH<sub>3</sub> 1 HR (Isopleth in microgram/m<sup>3</sup>)**

LEGEND: Yellow Triangles refer to identified ASRs  
 Area Sensitive Receptor (ASRs)

	Long	Lat
ASR1	327812	462536
ASR2	327938	462105
ASR3	326839	462822
ASR4	326087	462455
ASR5	326416	462929

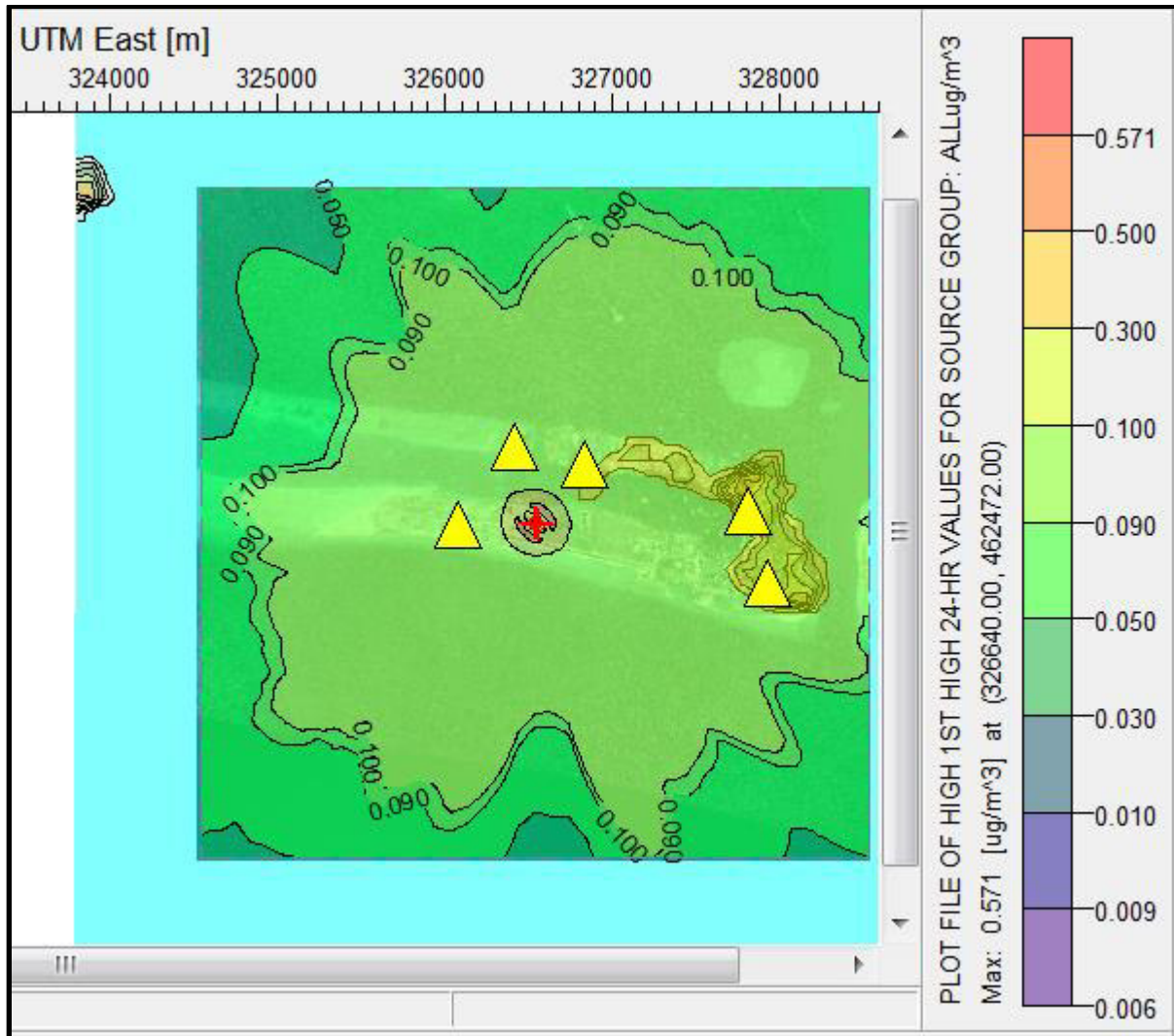


Figure 42: 5.19 NH<sub>3</sub> 24 HR (Isopleth in microgram/m<sup>3</sup>)

LEGEND: Yellow Triangles refer to identified ASRs  
 Area Sensitive Receptor (ASRs)

	Long	Lat
ASR1	327812	462536
ASR2	327938	462105
ASR3	326839	462822
ASR4	326087	462455
ASR5	326416	462929

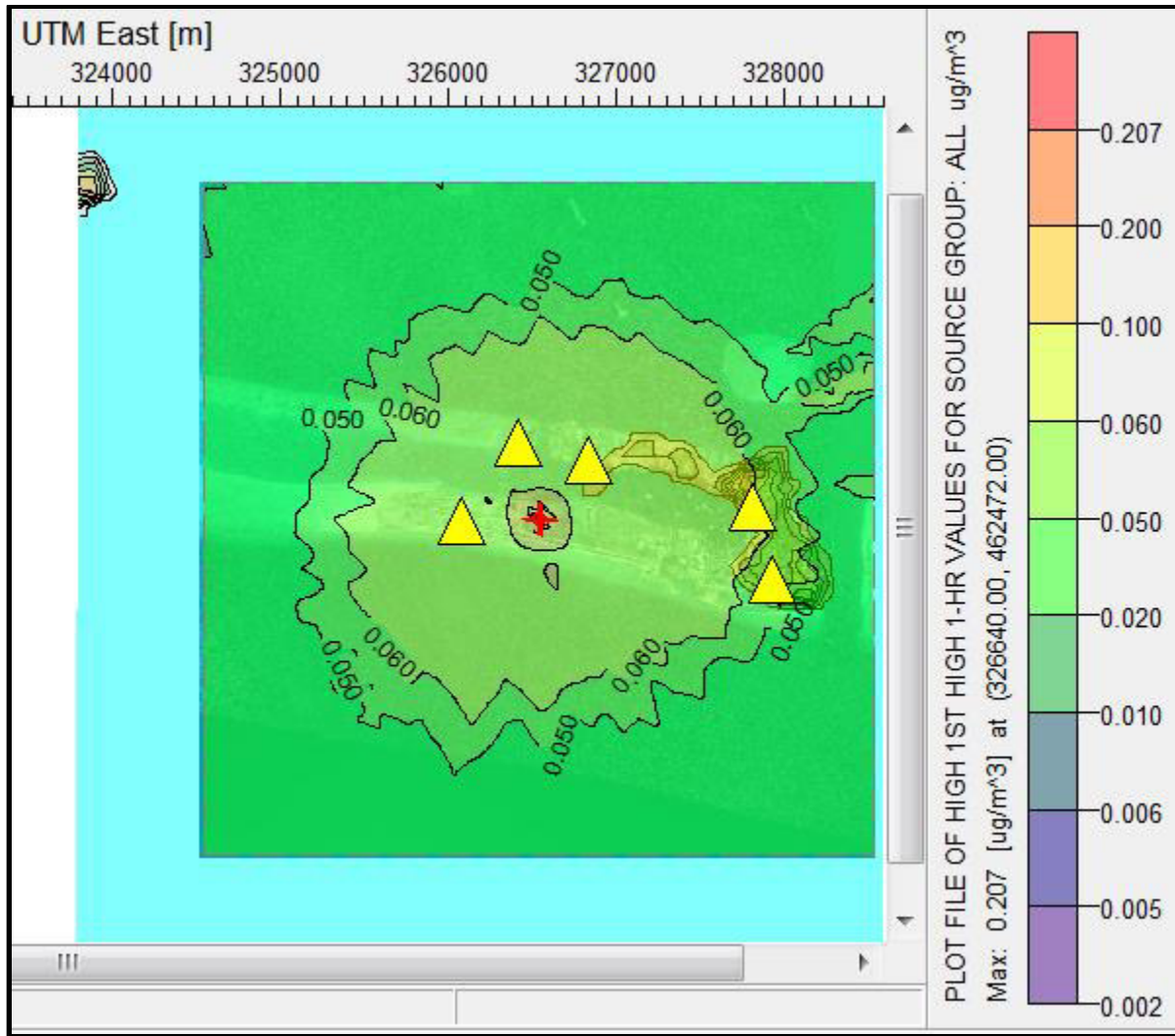


Figure 43: HF 1 HR (Isopleth in microgram/m<sup>3</sup>)

LEGEND: Yellow Triangles refer to identified ASRs  
 Area Sensitive Receptor (ASRs)

	Long	Lat
ASR1	327812	462536
ASR2	327938	462105
ASR3	326839	462822
ASR4	326087	462455
ASR5	326416	462929

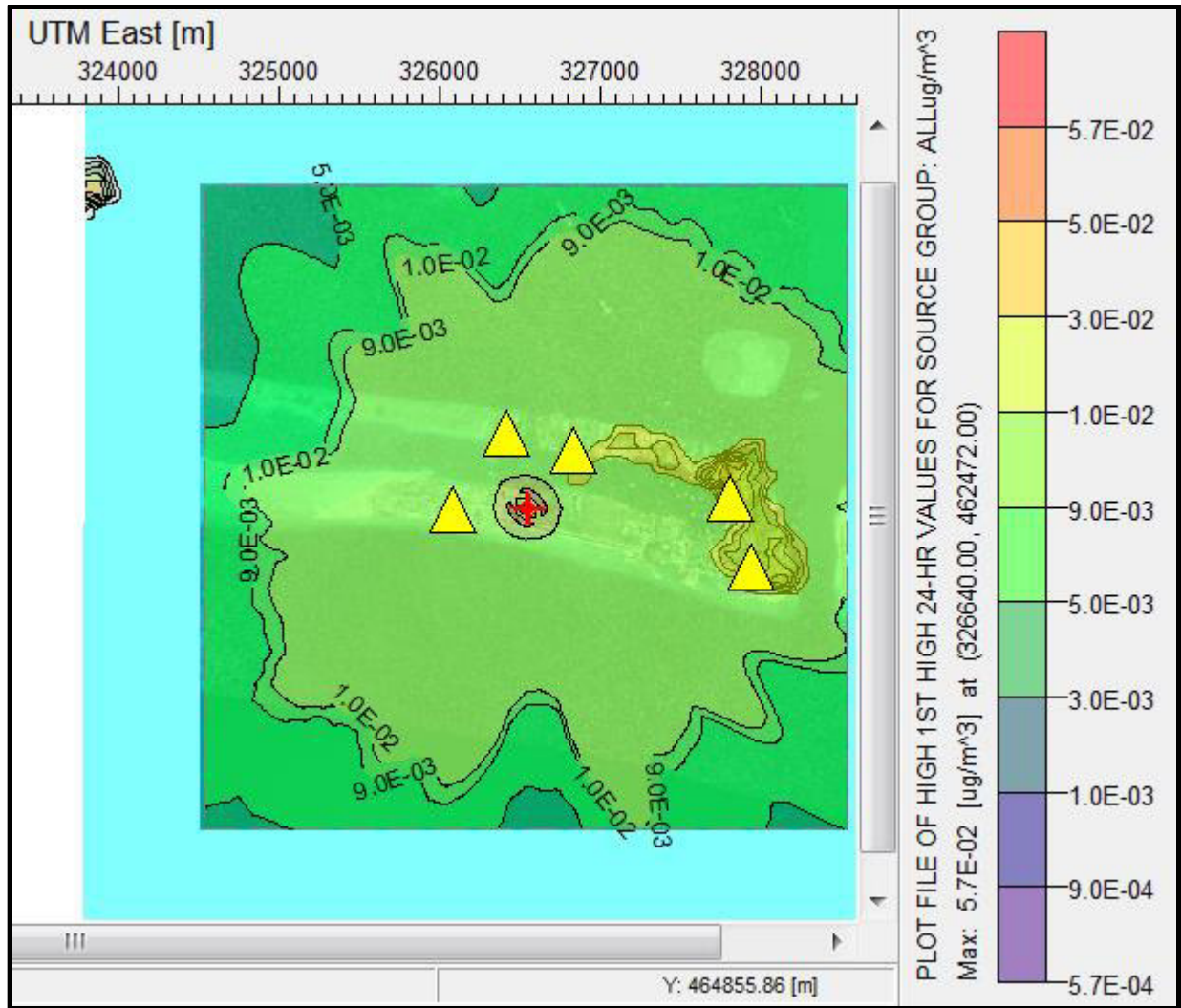


Figure 44: HF 24 HR (Isopleth in microgram/m3)

LEGEND: Yellow Triangles refer to identified ASRs  
 Area Sensitive Receptor (ASRs)

	Long	Lat
ASR1	327812	462536
ASR2	327938	462105
ASR3	326839	462822
ASR4	326087	462455
ASR5	326416	462929

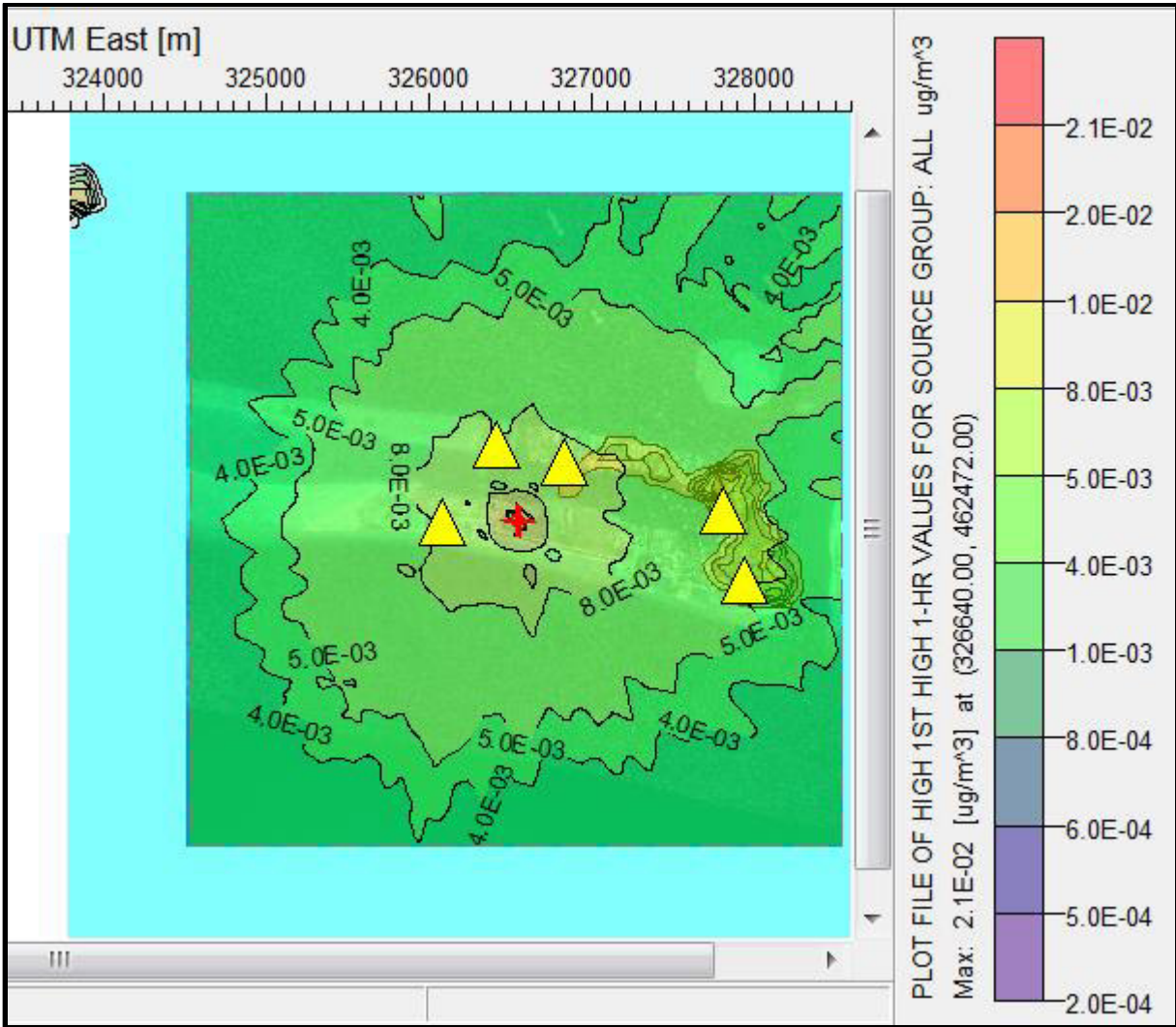


Figure 45: Dioxin and Furans 1 HR (Isopleth in microgram/m3)

LEGEND: Yellow Triangles refer to identified ASRs  
 Area Sensitive Receptor (ASRs)

	Long	Lat
ASR1	327812	462536
ASR2	327938	462105
ASR3	326839	462822
ASR4	326087	462455
ASR5	326416	462929



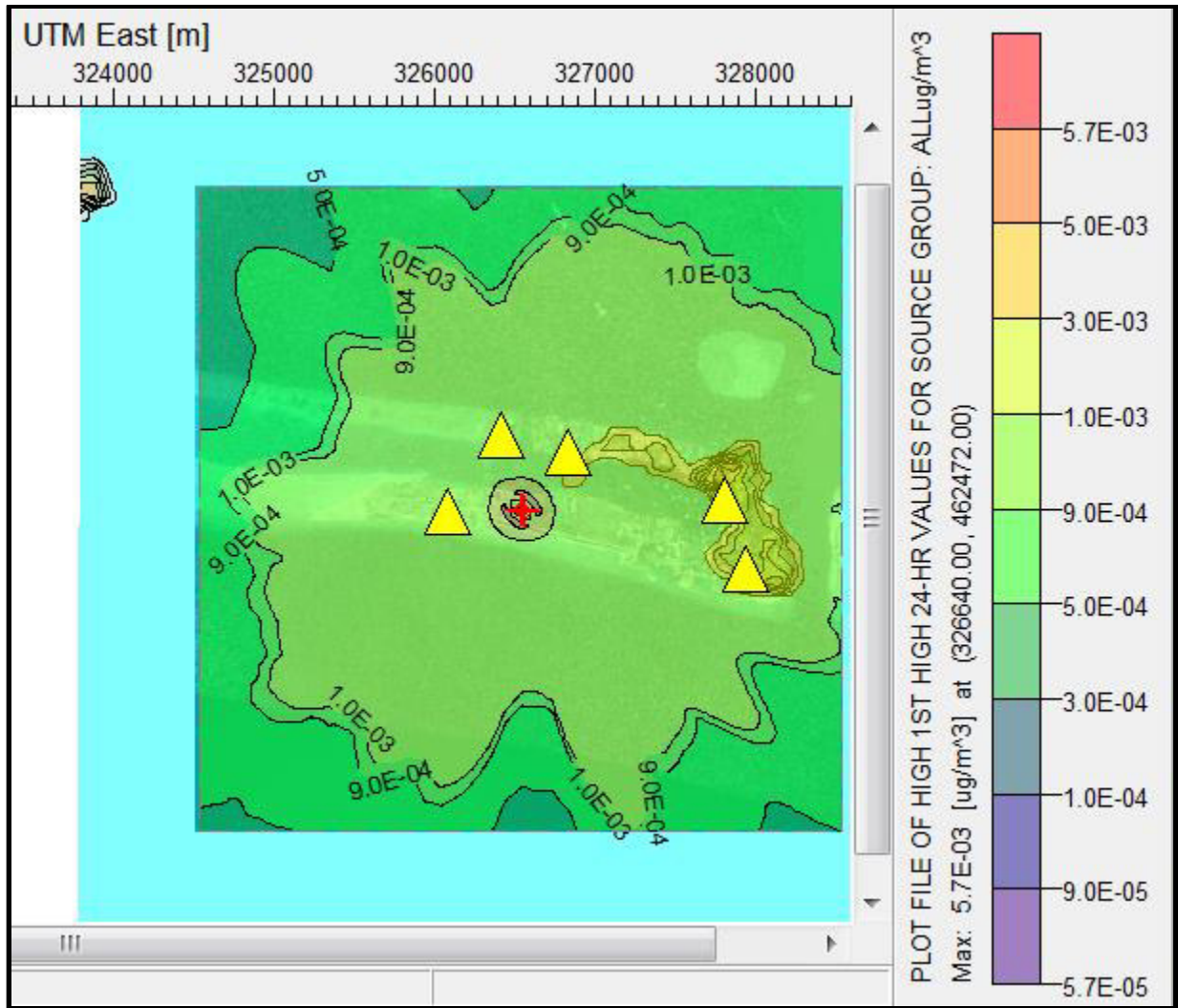
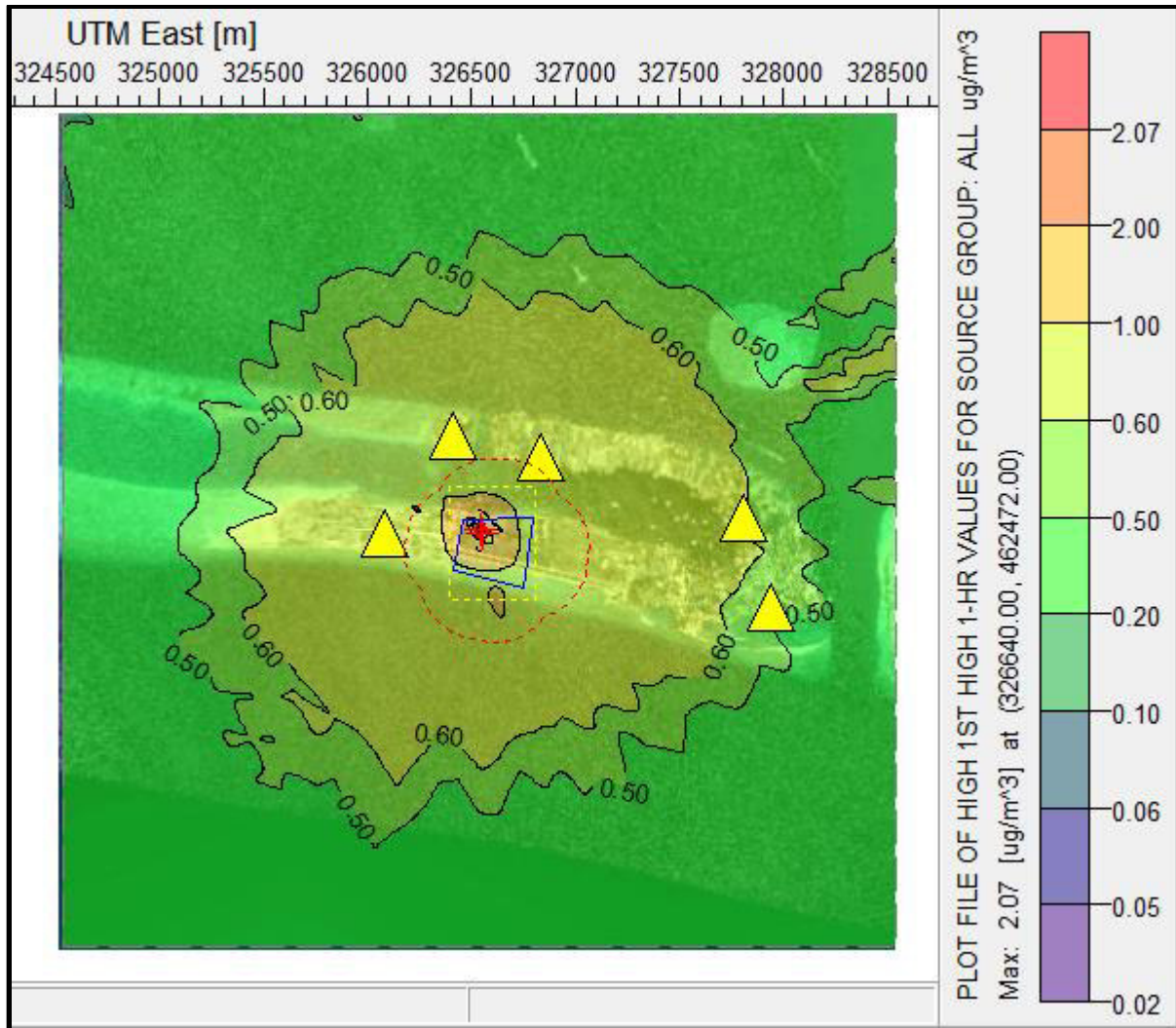


Figure 46: Dioxin and Furans 24 HR (Isopleth in microgram/m<sup>3</sup>)

LEGEND: Yellow Triangles refer to identified ASRs  
 Area Sensitive Receptor (ASRs)

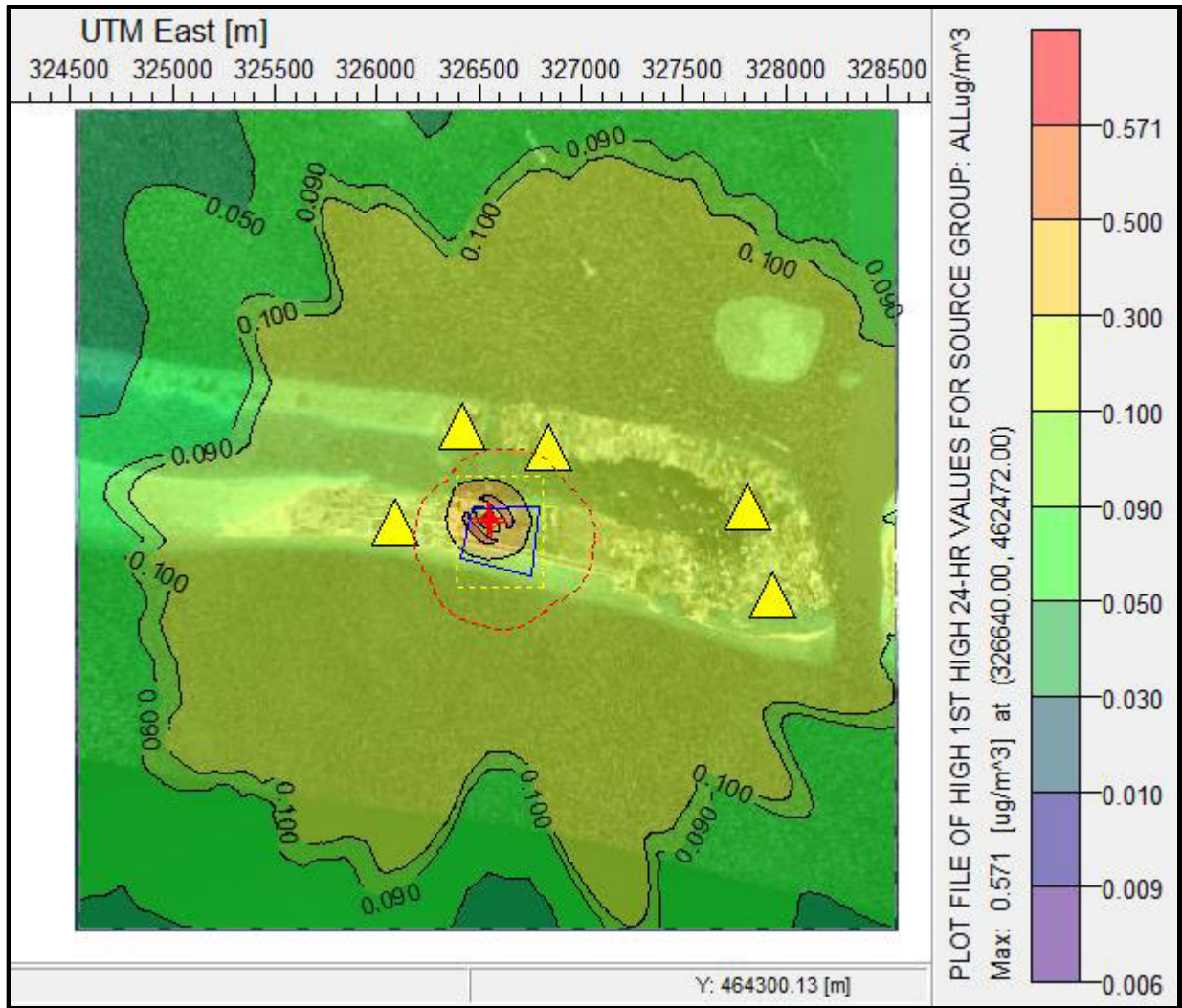
	Long	Lat
ASR1	327812	462536
ASR2	327938	462105
ASR3	326839	462822
ASR4	326087	462455
ASR5	326416	462929



**Figure 47: HCl 1 HR (Isopleth in microgram/m<sup>3</sup>)**

LEGEND: Yellow Triangles refer to identified ASRs  
 Area Sensitive Receptor (ASRs)

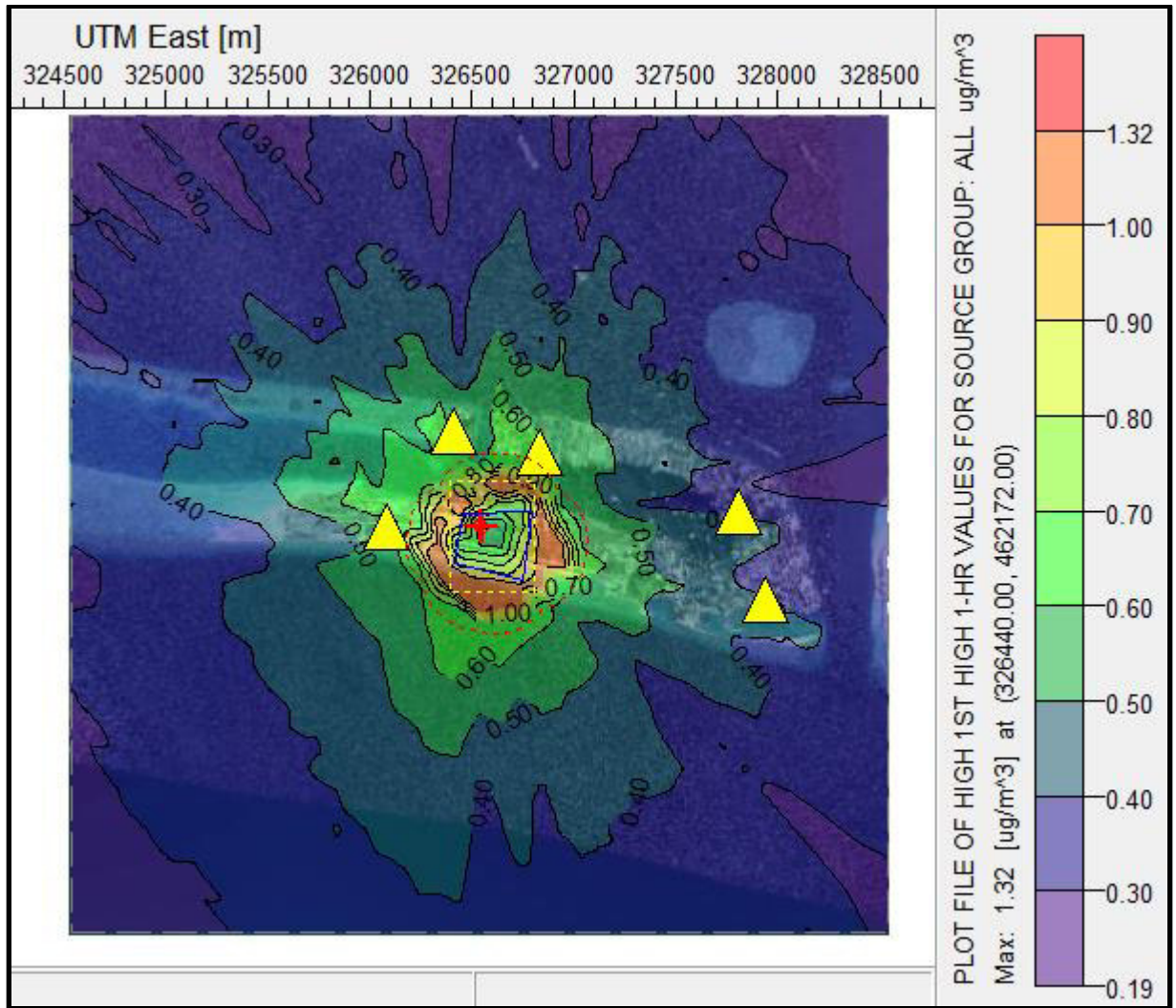
	Long	Lat
ASR1	327812	462536
ASR2	327938	462105
ASR3	326839	462822
ASR4	326087	462455
ASR5	326416	462929



**Figure 48: HCl 24 HR (Isopleth in microgram/m<sup>3</sup>)**

LEGEND: Yellow Triangles refer to identified ASRs  
 Area Sensitive Receptor (ASRs)

	Long	Lat
ASR1	327812	462536
ASR2	327938	462105
ASR3	326839	462822
ASR4	326087	462455
ASR5	326416	462929



**Figure 49: Sb 1 HR (Isopleth in microgram/m<sup>3</sup>)**

LEGEND: Yellow Triangles refer to identified ASRs  
 Area Sensitive Receptor (ASRs)

	Long	Lat
ASR1	327812	462536
ASR2	327938	462105
ASR3	326839	462822
ASR4	326087	462455
ASR5	326416	462929



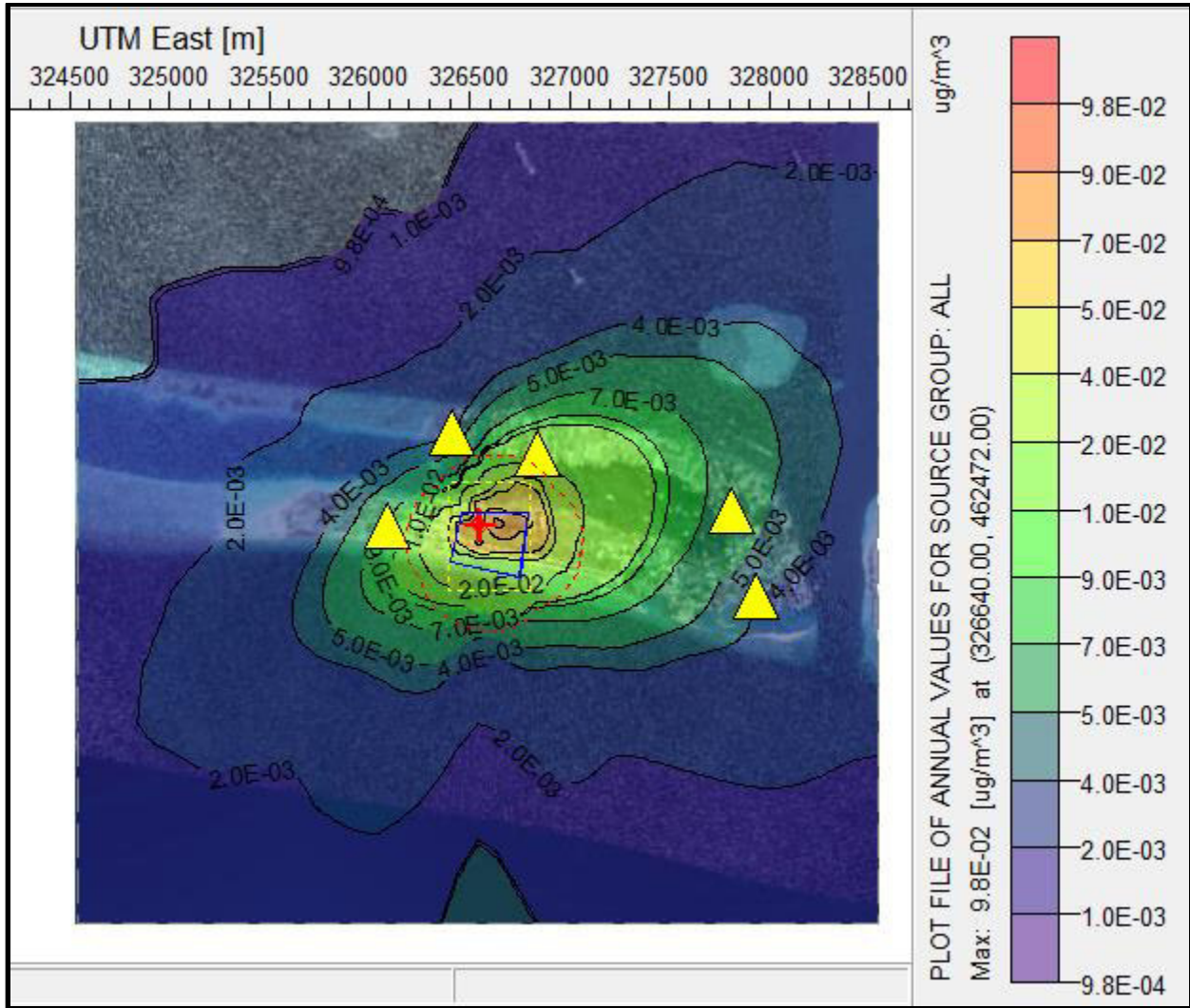
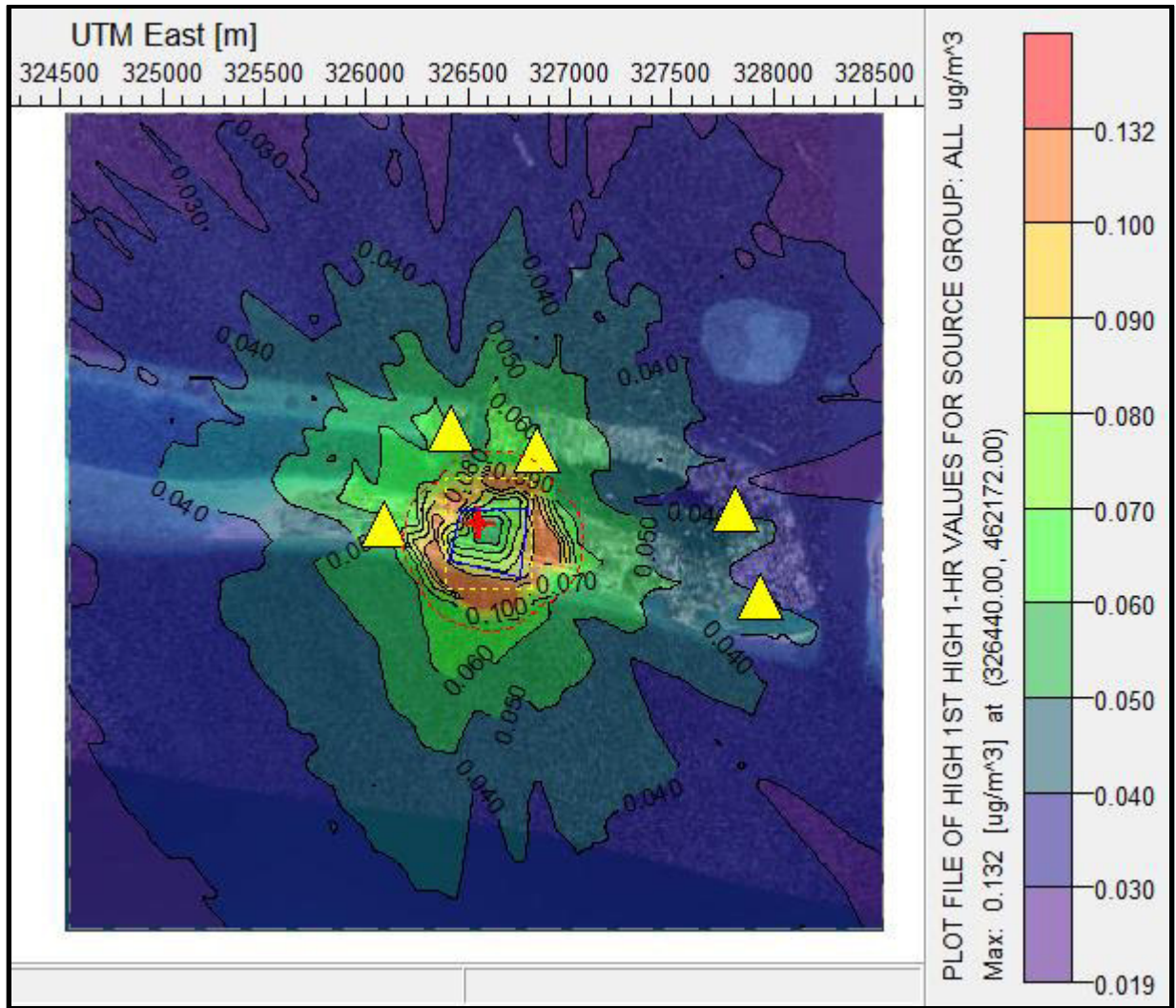


Figure 51: Sb 1 YR (Isopleth in microgram/m<sup>3</sup>)

LEGEND: Yellow Triangles refer to identified ASRs  
 Area Sensitive Receptor (ASRs)

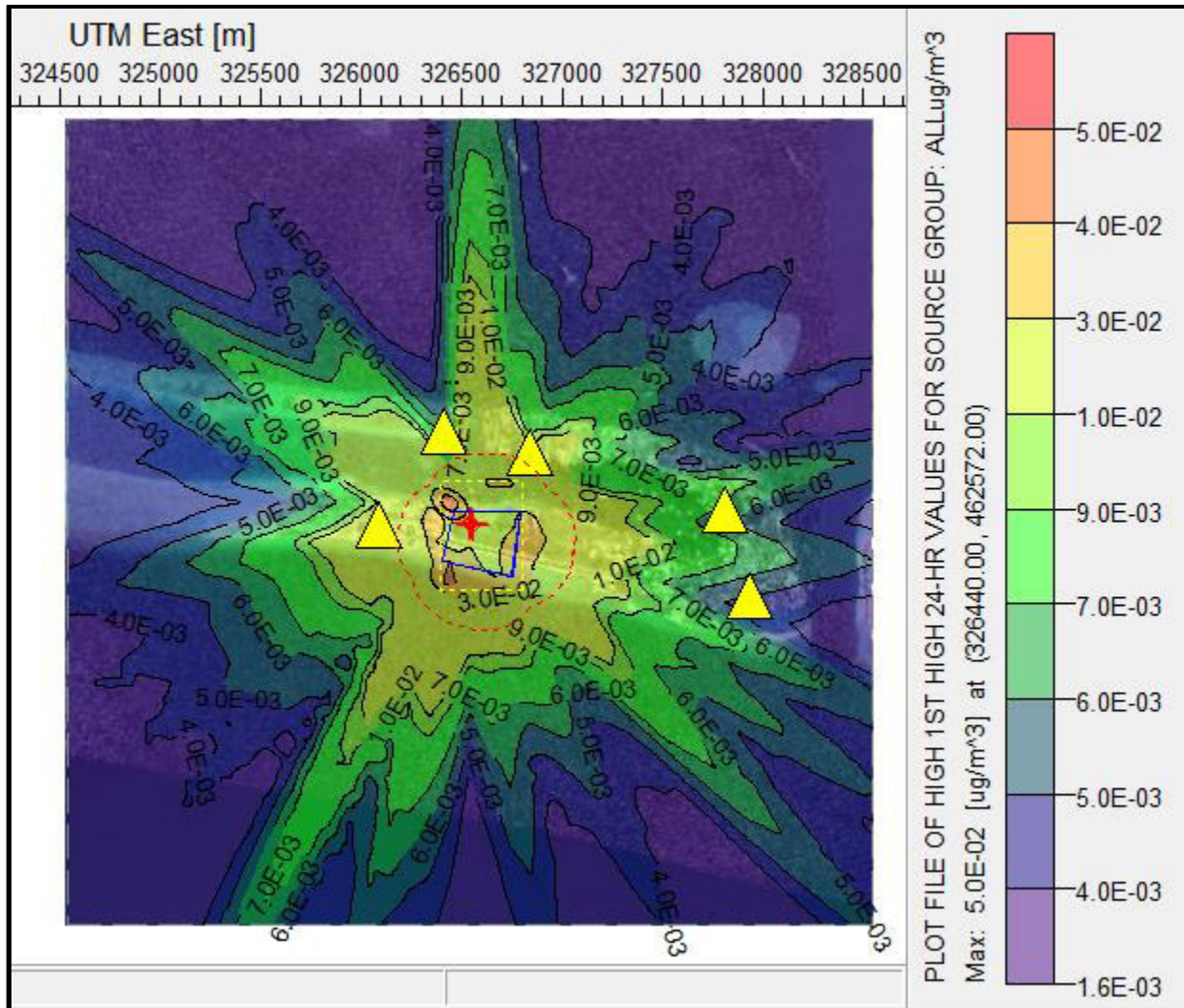
	Long	Lat
ASR1	327812	462536
ASR2	327938	462105
ASR3	326839	462822
ASR4	326087	462455
ASR5	326416	462929



**Figure 52: As 1 HR (Isopleth in microgram/m<sup>3</sup>)**

LEGEND: Yellow Triangles refer to identified ASRs  
 Area Sensitive Receptor (ASRs)

	Long	Lat
ASR1	327812	462536
ASR2	327938	462105
ASR3	326839	462822
ASR4	326087	462455
ASR5	326416	462929

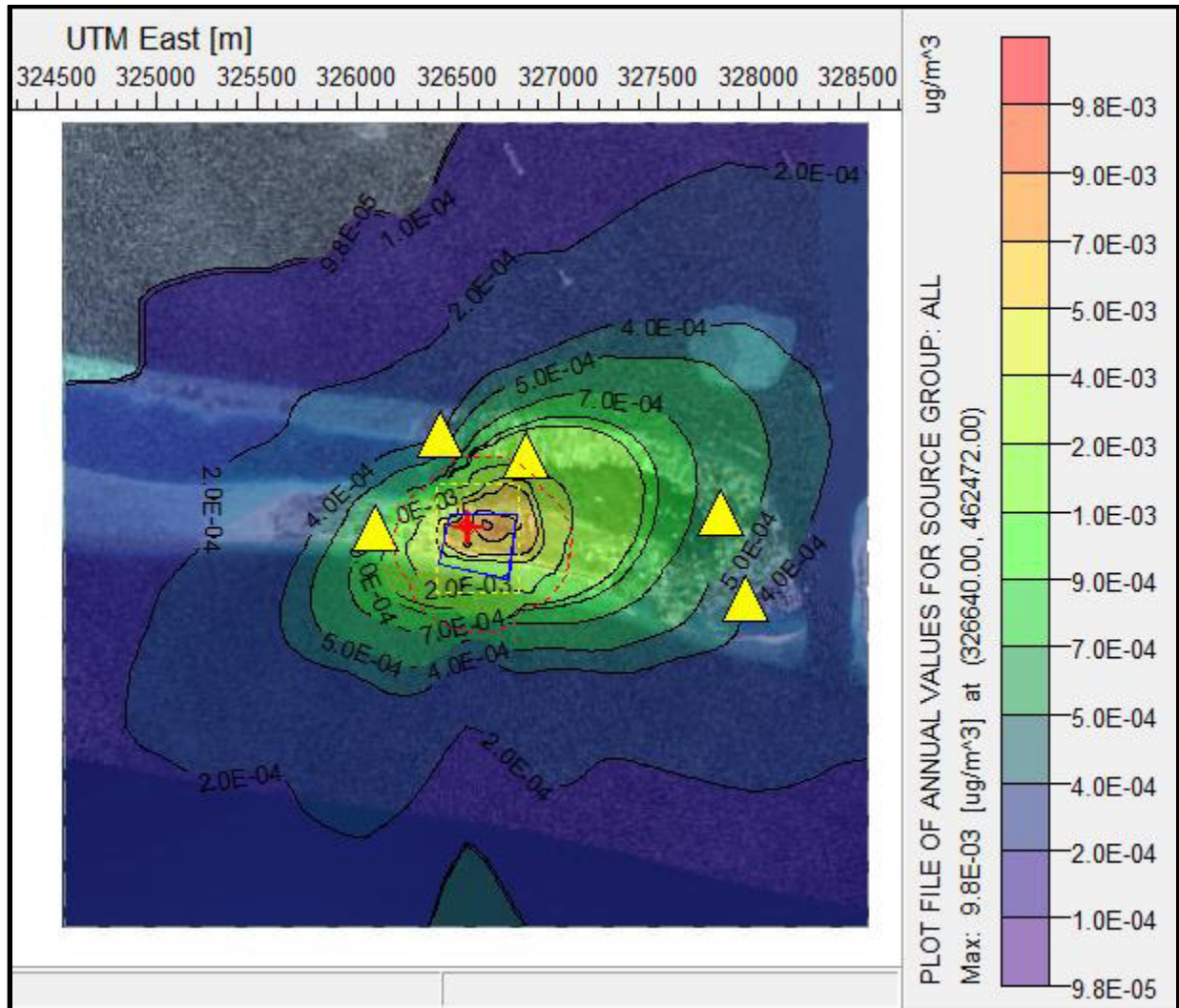


**Figure 53: As 24 HR (Isopleth in microgram/m3)**

LEGEND: Yellow Triangles refer to identified ASRs  
 Area Sensitive Receptor (ASRs)

	Long	Lat
ASR1	327812	462536
ASR2	327938	462105
ASR3	326839	462822
ASR4	326087	462455
ASR5	326416	462929

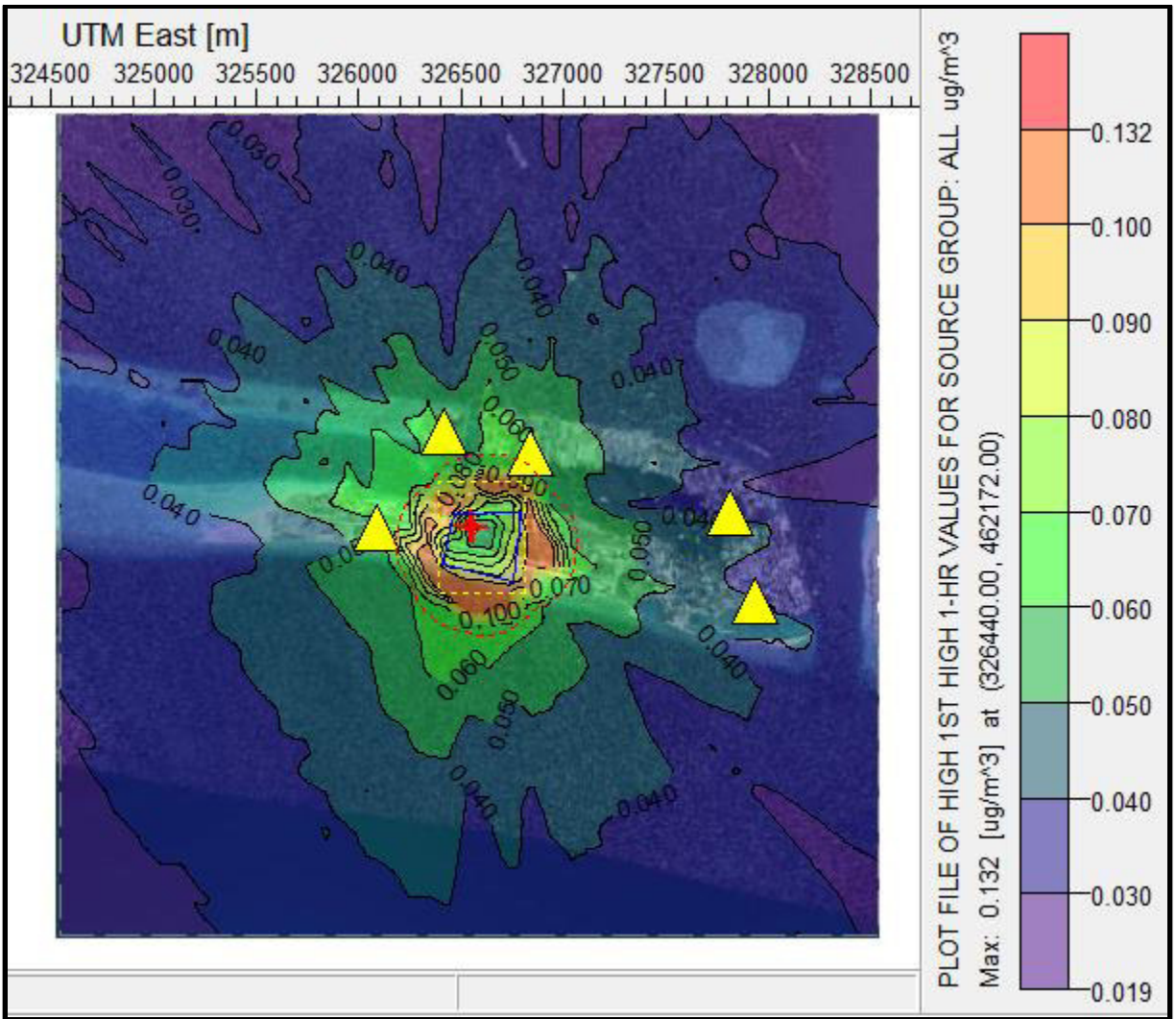




**Figure 54: As 1 YR (Isopleth in microgram/m<sup>3</sup>)**

LEGEND: Yellow Triangles refer to identified ASRs  
 Area Sensitive Receptor (ASRs)

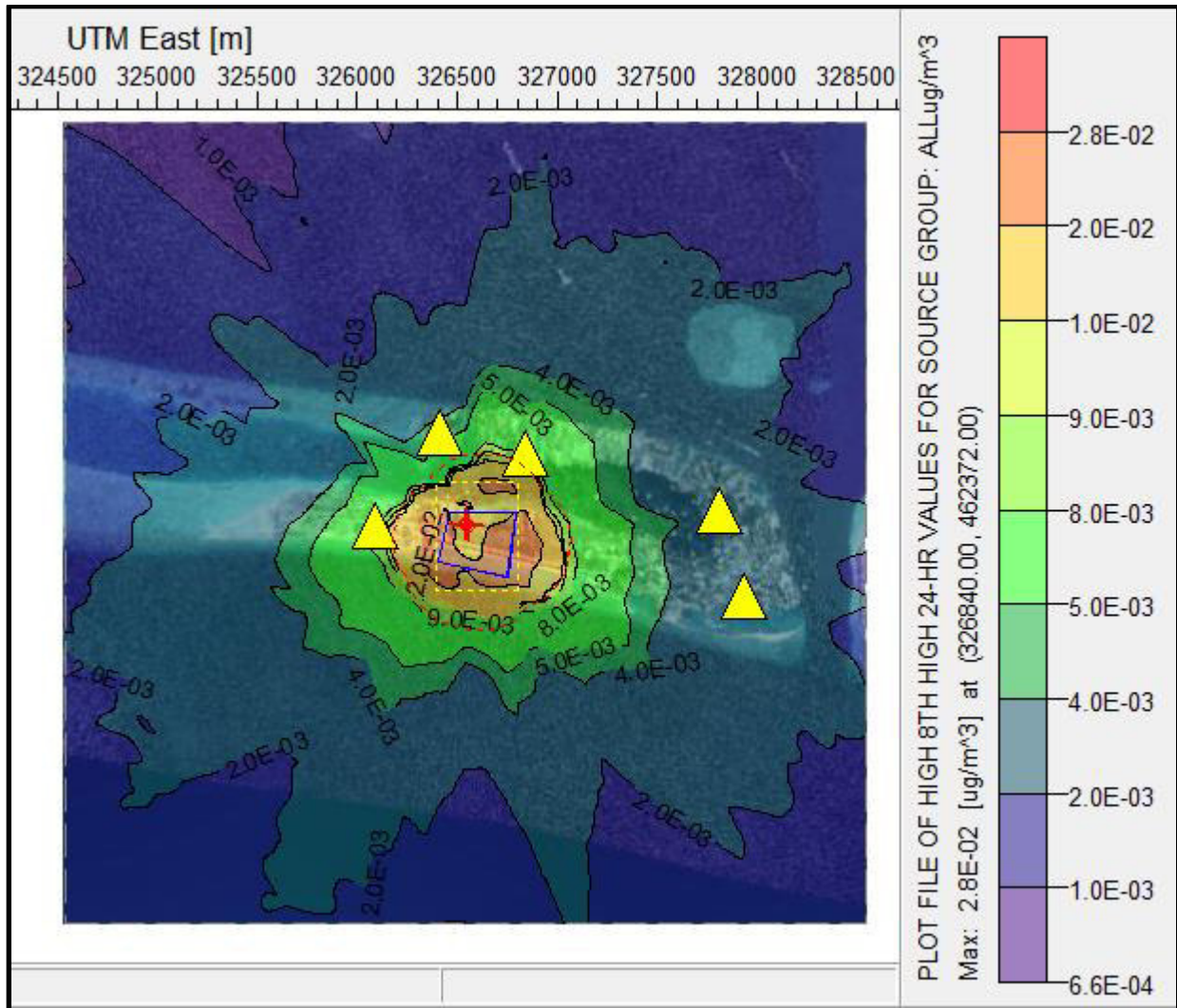
	Long	Lat
ASR1	327812	462536
ASR2	327938	462105
ASR3	326839	462822
ASR4	326087	462455
ASR5	326416	462929



**Figure 55: TI 1 HR (Isopleth in microgram/m3)**

LEGEND: Yellow Triangles refer to identified ASRs  
 Area Sensitive Receptor (ASRs)

	Long	Lat
ASR1	327812	462536
ASR2	327938	462105
ASR3	326839	462822
ASR4	326087	462455
ASR5	326416	462929



**Figure 56: TI 24 HR (Isopleth in microgram/m<sup>3</sup>)**

LEGEND: Yellow Triangles refer to identified ASRs  
 Area Sensitive Receptor (ASRs)

	Long	Lat
ASR1	327812	462536
ASR2	327938	462105
ASR3	326839	462822
ASR4	326087	462455
ASR5	326416	462929

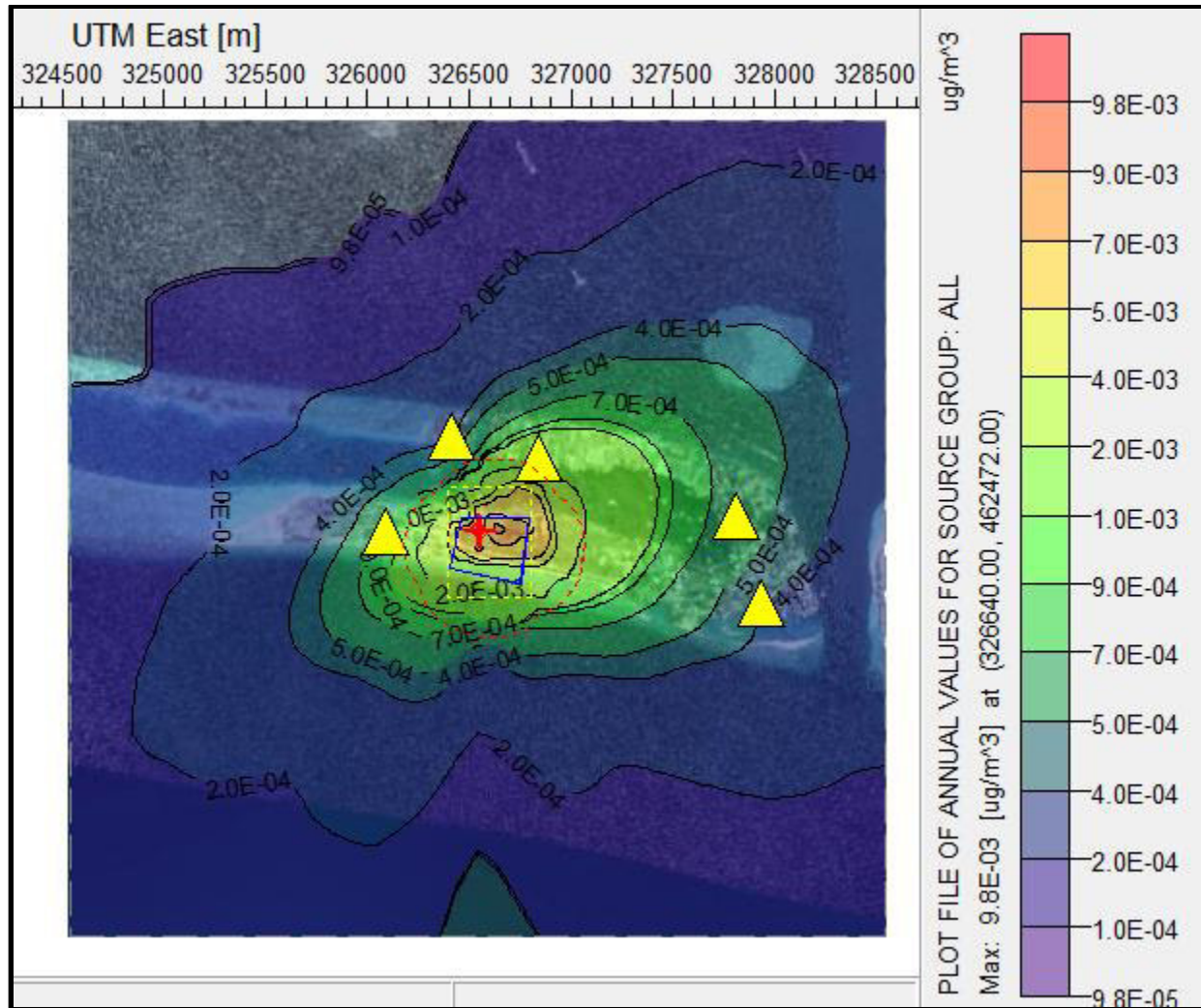


Figure 57: TI 1 YR (Isopleth in microgram/m3)

LEGEND: Yellow Triangles refer to identified ASRs  
 Area Sensitive Receptor (ASRs)

	Long	Lat
ASR1	327812	462536
ASR2	327938	462105
ASR3	326839	462822
ASR4	326087	462455
ASR5	326416	462929

## 10. DISCUSSION OF RESULTS

### 10.1 AERMOD VER.9.1 MODEL RUN USING TIER 3 MET DATA (MALDIVES METEOROLOGY)

Figures 24 to 48 are the results of the predictive peak values of emission dispersion modeling presented in 2 dimensional graphs: 4000 m (4km) X 4000 m (4 km). Dispersion model results are presented in 2-dimension graphical presentation Distance (X-axis) and Concentration ug/Ncm (Y-axis). Raw data of results are in output files presented in the following Nomenclature: (x=distance from source, km), conc=ground-level centerline concentration, ug/m<sup>3</sup>), (sigmay=dispersion coefficient in Y direction, dimensionless) , (sigmaz=dispersion coefficient in Z direction, dimensionless), (xf=distance to final plume rise, km) , (h=plume height, m).

## 10.2 TOTAL DUST (TD)

Predicted short term (1 hour) for controlled<sup>14</sup> total dust (TD) maximum ground level concentrations is 7.60 ug/m<sup>3</sup> located 280 meters ENE from the center of the domain. The 24 hour controlled total dust (TD) maximum ground level concentrations is 3.188 ug/m<sup>3</sup> located 608 meters ENE from the center of the domain. Simulated concentrations for maximum ground level concentration for 1 hour total dust (TD) are generally very low. There is no available the Ambient Air Quality Standards for total dust in the Austal2000 Report. For the total dust (TD) deposition, AERMOD results shows 0.00754 g/m<sup>2</sup> for 1 hour, 0.038505 g/m<sup>2</sup> for 24 hr, and 0.43394 g/m<sup>2</sup> for 1 year deposition. Deposition simulations are all below the TALuft precipitation limit of 0.35 g/m<sup>2</sup>-d. There are no applicable USEPA standards and WHO Air Quality Guideline Values. Reference center of the domain is the location of the Boiler Stack-1 at Universal Transverse Mercator (UTM) coordinates Easting 326540 and Northing 462472.

## 10.3 PARTICULATE MATTER 10 (PM-10)

Predicted short term (1 hour) for controlled particulate matter 10 (PM-10) maximum ground level concentrations is 0.102 ug/m<sup>3</sup> located 100 meters E from the center of the domain. The 24-hour controlled PM-10 maximum ground level concentrations is 0.02844 ug/m<sup>3</sup> located 100 meters E from the center of the domain. Simulated concentration for maximum ground level concentration for 24 hour PM10 is below the 35 ug/m<sup>3</sup> TA Luft standards. There is no available Ambient Air Quality Standards for PM-10 in the Austal2000 report. For the PM-10 deposition, AERMOD results shows 0.00037 g/m<sup>2</sup> for 1 hour, 0.0007g/m<sup>2</sup> for 24 hour and 0.025 g/m<sup>2</sup> for 1 year deposition. There is no TALuft limit for PM10 for 1-hour in the Austal2000 report. Results are below TA Luft and WHO Air Quality Guideline Values. There are no USEPA standards in ug/Nm<sup>3</sup> unit, the values used are converted from parts per billion by volume (ppbv). The results show insignificant increase of 0.51% for 1-hour, 0.06% for 24-hour, and 0.01% for 1-year. Reference center of the domain is the location of the Boiler Stack-1 at UTM coordinates Easting 326540 and Northing 462472.

## 10.4 SULFUR DIOXIDE (SO<sub>2</sub>)

Predicted short term (1 hour) for controlled sulfur dioxide (SO<sub>2</sub>) maximum ground level concentrations is 10.34 ug/m<sup>3</sup> located 100 meters E from the center of the domain. The 24 hour controlled SO<sub>2</sub> maximum ground level concentrations is 2.85 ug/m<sup>3</sup> located 100 meters E from the center of the domain. For 1-year averaging time, results of maximum concentration is 0.25302 ug/m<sup>3</sup>. Results for maximum ground level concentration for 1 hour, 24 hour and 1 year SO<sub>2</sub> are all below the TA Luft standards of 350 ug/m<sup>3</sup> for 1 hour, 125 ug/m<sup>3</sup> for 24 hr and 50 ug/m<sup>3</sup> for 1 year respectively. There are no USEPA standards in ug/Nm<sup>3</sup> unit, the values used are converted from parts per billion by volume (ppbv). The results show insignificant increase of 4.88% for 1-

---

<sup>14</sup> Controlled emission parameters refer to post-air pollution control devices. For the WtE, each stack will include baghouse and electrostatic precipitators.

hour, 14.29% for 24-hour, and 0.32% for 1-year. Reference center of the domain is the location of the Boiler Stack-1 at UTM coordinates Easting 326540 and Northing 462472.

### **10.5 NITROGEN OXIDES (NOX)**

Predicted short term (1 hour) for controlled NO<sub>2</sub> maximum ground level concentrations is 48.91 ug/m<sup>3</sup> located 100 meters E from the center of the domain. The 24 hour controlled NO<sub>2</sub> maximum ground level concentrations is 14.16 ug/m<sup>3</sup> located 100 meters E from the center of the domain. For 1 year averaging time, results of maximum NO<sub>2</sub> concentration is 2.1 ug/m<sup>3</sup>. Simulated concentration for maximum NO<sub>2</sub> ground level concentration for 1 year is below the TA Luft standards of 40 ug/m<sup>3</sup>. There are no USEPA standards in parts per billion by volume (ppbv) therefore cannot be converted to ug/Nm<sup>3</sup> unit. The results show increase of 24.46% for 1-hour, and 5.25% for 1-year if compared to WHO Air Quality Guidelines. Reference center of the domain is the location of the Boiler Stack-1 at UTM coordinates Easting 326540 and Northing 462472.

### **10.6 MERCURY (HG)**

Predicted short term (1 hour) for controlled mercury (Hg) maximum ground level concentrations is 0.00643 ug/m<sup>3</sup> located 100 meters E from the center of the domain. The 24 hour controlled Hg maximum ground level concentrations is 0.00178 ug/m<sup>3</sup> located 100 meters E from the center of the domain. For 1 year averaging time, results of maximum concentration is 0.0057 ug/m<sup>3</sup>. There are no TA Luft, USEPA standards and WHO Air Quality Guideline Values. The results show insignificant increase of 0.18% for 24-hour and 3.14% for 1-year using TA Luft standards. Reference center of the domain is the location of the Boiler Stack-1 at UTM coordinates Easting 326540 and Northing 462472.

### **10.7 AMMONIA (NH<sub>3</sub>)**

Predicted short term (1 hour) for controlled ammonia (NH<sub>3</sub>) maximum ground level concentrations is 2.066 ug/m<sup>3</sup> located 100 meters E from the center of the domain. The 24 hour controlled NH<sub>3</sub> maximum ground level concentrations is 0.57123 ug/m<sup>3</sup> located 100 meters E from the center of the domain. There are no NH<sub>3</sub> TA Luft standards in the Austal2000 report. There are no USEPA standards and WHO Air Quality Guideline Values. Reference center of the domain is the location of the Boiler Stack-1 at UTM coordinates Easting 326540 and Northing 462472.

### **10.8 HYDROGEN CHLORIDE (HCL)**

Predicted short term (1 hour) for controlled hydrogen chloride (HCl) maximum ground level concentrations is 2.066 ug/m<sup>3</sup> located 100 meters E from the center of the domain. The 24 hour controlled NH<sub>3</sub> maximum ground level concentrations is 0.57123 ug/m<sup>3</sup> located 100 meters E from the center of the domain. There are no HCl TA Luft standards in the Austal2000 report. There are no USEPA standards and WHO Air Quality Guideline Values. Reference center of the domain is the location of the Boiler Stack-1 at UTM coordinates Easting 326540 and Northing 462472.

### **10.9 HYDROGEN FLOURIDE (HFL)**

Predicted short term (1 hour) for controlled hydrogen fluoride (HFI) maximum ground level concentrations is 2.066 ug/m<sup>3</sup> located 100 meters E from the center of the domain. The 24 hour

controlled HFI maximum ground level concentrations is 0.57123 ug/m<sup>3</sup> located 100 meters E from the center of the domain. There are no HFI TA Luft standards in the Austal2000 report. There are no USEPA standards and WHO Air Quality Guideline Values. Reference center of the domain is the location of the Boiler Stack-1 at UTM coordinates Easting 326540 and Northing 462472.

#### **10.11 DIOXINS AND FURANS (D/F)**

Predicted short term (1 hour) for controlled Dioxins and Furans maximum ground level concentrations is 0.0258 ug/m<sup>3</sup> located 100 meters E from the center of the domain. The 24 hour controlled Dioxins and Furans maximum ground level concentrations is 0.00569 ug/m<sup>3</sup> located 100 meters E from the center of the domain. There are no Dioxins and Furans TA Luft standards in the Austal2000 report. There are no USEPA standards and WHO Air Quality Guideline Values. Reference center of the domain is the location of the Boiler Stack-1 at UTM coordinates Easting 326540 and Northing 462472.

#### **10.12 SUM OF HEAVY METALS AND THEIR COMPONENTS: ANTIMONY, CHROMIUM, COPPER, MANGANESE, VANADIUM, TIN, LEAD, COBALT, NICKEL (TA LUFT CLASS II AND III)**

Predicted short term (1 hour) for the Sum of heavy metals and their components: antimony, chromium, copper, manganese, vanadium, tin, lead, cobalt, nickel (TA Luft class II and III) ground level concentrations is 1.3161 ug/m<sup>3</sup> located 316 meters NorthNorthEast (NNE) from the center of the domain. The 24 hour controlled total sum of metals maximum ground level concentrations is 0.4954 ug/m<sup>3</sup> located 141 meters NorthWest (NW) from the center of the domain. For 1 year averaging time, results of maximum concentration is 0.0982 ug/m<sup>3</sup>. Simulated concentrations for maximum ground level concentration for both 1, 24 hours & 1 Year averaging which are generally very low. Results are generally lower than US RSLs for combined 24 hr averaging for Cu, Vn, Cr and Mn of 0.152 ug/m<sup>3</sup> and the 3 month NAAQS for Lead of 0.15 ug/m<sup>3</sup>. There is no available the Ambient Air Quality Standards for said metals in the Austal2000 Report. Reference center of the domain is the location of the Boiler Stack-1 at UTM coordinates Easting 326540 and Northing 462472.

#### **10.13 ARSENIC / CADMIUM AND ITS COMPOUNDS (EXPRESSED AS AS AND CD), BENZO (A) PYRENE, WATER-SOLUBLE COBALT COMPOUNDS (EXPRESSED AS CO), CHROMIUM (VI) COMPOUNDS (EXPRESSED AS CR) (TA LUFT CLASS I)**

Predicted short term (1 hour) for the Sum of heavy metals and their components: Arsenic / cadmium and its compounds (expressed as As and Cd), benzo (a) pyrene, water-soluble cobalt compounds (expressed as Co), chromium (VI) compounds (expressed as Cr) (TA Luft Class I) ground level concentrations is 0.13161 ug/m<sup>3</sup> located 316 meters NorthNorthEast (NNE) from the center of the domain. The 24 hour controlled total sum of metals maximum ground level concentrations is 0.049 ug/m<sup>3</sup> located 141 meters NorthWest (NW) from the center of the domain. For 1 year averaging time, results of maximum concentration is 0.00982 ug/m<sup>3</sup>. Simulated concentrations for maximum ground level concentration for both 1, 24 hours & 1 Year averaging which are generally very low. Results are generally lower than the available ESL for Arsenic of 3 ug/m<sup>3</sup> and 0.067 ug/m<sup>3</sup> for 1 year. There is no available the Ambient Air Quality Standards for said metals in the Austal2000 Report. Reference center of the domain is the location of the Boiler Stack-1 at UTM coordinates Easting 326540 and Northing 462472.

#### **10.14 THALLIUM AND ITS COMPOUNDS ( TA LUFT CLASS I) CADMIUM**

Predicted short term (1 hour) for the Sum of heavy metals and their components: Thallium and its compounds ( TA Luft class I) cadmium ground level concentrations is 0.13161 ug/m<sup>3</sup> located 316 meters NorthNorthEast (NNE) from the center of the domain. The 24 hour controlled total sum of metals maximum ground level concentrations is 0.049 ug/m<sup>3</sup> located 141 meters NorthWest (NW) from the center of the domain. For 1 year averaging time, results of maximum concentration is 0.00982 ug/m<sup>3</sup>. Simulated concentrations for maximum ground level concentration for both 1, 24 hours & 1 Year averaging which are generally very low. There is no available the Ambient Air Quality Standards for said metals in the Austal2000 Report and in the USEPA NAAQS, ESLs and RSLs. Reference center of the domain is the location of the Boiler Stack-1 at UTM coordinates Easting 326540 and Northing 462472.

#### **10.15 OVERALL RESULTS**

AERMOD validation of the Austal2000 model results shows slightly higher results than the Austal2000 report but still within TA Luft Standards, USEPA Standards and WHO Air Quality Guideline Values. For the deposition results, Total Dust, SO<sub>2</sub>, NO<sub>2</sub> and Hg are confirmed to be way below the 1 year TA Luft precipitation standards. Toxic heavy metal parameters such Ni, Ti, As, Cd, and Pb was excluded in the validation model due to absence of design emission data. For all the above parameters, controlled emissions have been validated to be in compliance with the TA Luft Standards as provided in the Austal2000 Report and with the USEPA standards.

Based on the design emission of the proposed WTE plant, proposed stack height of 50 meters in the Austal2000 report was found to be favorable considering all predicted ground level concentrations in the AERMOD validation model are below the TA Luft and USEPA standards.



### 10.16 AERMOD VER.9.1 MODEL MAXIMUM GROUND LEVEL CONCENTRATIONS IN AREA SENSITIVE RECEPTORS (ASR-GLCMAX)

Results of the dispersion model in Table 8 shows highest predicted ground level concentrations (GLC) in ASRs for TSP, CO SO2 and NO2 for 1-hour and 24-hour period. Predicted peak values for 1 year are below 0.00000 ug/Ncm and considered not significant. GLCs for 1-hour and 24-hour period are all below applicable ambient air quality standards.

**Table 8: TABLE OF NOTEABLE PEAK VALUES IN AREA SENSITIVE RECEPTORS AREAS (ASRs)**

Receptor ID	Receptor Description	Direction	UTM Coordinates		PARAMETERS (ug/Ncm)											
			Easting (m)	Northing (m)	TD 1 hour	TD 24 hour	PM10 1 hour	PM10 24 hour	NO2 1 hour	NO2 24 hour	SO2 1 hour	SO2 24 hour	Hg 1 hour	Hg 24 hour	D/F 1 hour	D/F 24 hour
Applicable Standards					-	-	20	50	200	-	212	20	-	-	-	-
ASR 1	Industrial	1273.25	327812	462536	0.444	0.188	0.031	0.009	16.672	6.623	3.111	0.922	0.019	0.006	0.023	0.007
ASR 2	Industrial	1445.55	327938	462105	0.395	0.159	0.027	0.008	14.967	5.577	2.712	0.790	0.017	0.005	0.020	0.006
ASR 3	Industrial	459.87	326839	462822	0.656	0.213	0.045	0.014	23.098	7.466	4.537	1.379	0.028	0.009	0.034	0.010
ASR 4	Industrial	453.28	326087	462455	0.634	0.217	0.041	0.014	22.492	7.298	4.144	1.370	0.026	0.009	0.031	0.010
ASR 4	Industrial	473.64	326416	462929	0.713	0.216	0.043	0.012	24.549	7.393	4.351	1.206	0.027	0.008	0.032	0.009

## 11. RECOMMENDATIONS

The WTE Boilers should be regularly maintained and structure of the stack, ducts should be regularly checked up to avoid fugitive dusts sources and particulate accumulation. Biomass and municipal fuel should have an acceptance criteria such as moisture content and toxic characterization. Waste should be dried to eliminate moisture which is a precursor to incomplete combustion which is among major contributors to Particulate Matter (PM) and Carbon Monoxide (CO) emission. Control device such as the Dry scrubber and Baghouse is also recommended for regular check-up and maintenance.

Other control measures outside the facility are also recommended which include, periodic watering of roads for, minimizing generation and resuspension of dust particles. Forestation and plantation in perimeter-buffer areas are other effective controls. These areas will be protected by vegetation walls from dispersion of air pollutants. Other cleaner production measures are recommended.

Regular Ambient Air quality monitoring should be conducted in hot spots and impacts areas based on the results of this modelling report. Actual ambient monitoring may be treated as validation of model results. Every modification and installation of new sources should be considered by proponent as additional contribution to emission of the Power plant, hence modelling updates should also be conducted to determine assimilative carrying capacity of the area based on the impacts of the plant to the environment. These efforts will contribute to recommendations of the plant's overall management efforts to abate air pollution thus performing corporate responsibility to the environment and natural resources. It recommended to (i) retain the four (4) ambient monitoring stations used in conducting ambient air quality in Thillafushi island for the EIA study; and (ii) put up additional ambient monitoring stations in ASR 2, ASR 3 and ASR 5 areas due to industrial facilities with workers quarters.

According to WHO best practices in WTE plant, proper combustion design is among the important factor in reduction of emission. Proper design and operation of incinerators should achieve desired temperatures, residence times, and other conditions necessary to destroy pathogens, minimize emissions, avoid clinker formation and slagging of the ash (in the primary chamber), avoid refractory damage destruction, and minimize fuel consumption. Good combustion practice (GCP) elements also should be followed to control dioxin and furan emissions (Brna and Kilgroe 1989)<sup>15</sup>. Regardless of how well equipment is designed, wear and tear during normal use and poor operation and maintenance practices will lead to the deterioration of components, a resultant decrease in both combustion quality, an increase in emissions, and potential risks to the operator and public. Operation and maintenance also affect reliability, effectiveness and life of the equipment. Essentially all components of small-scale incinerators are prone to failure and require maintenance. Maintenance on an hourly to semi-annual schedule is required (EPA 1990). See Annex 1 and 2.

Background ambient air quality was not accounted in the modeling run. However given there are no potential significant sources of air pollution (such as mobile, area, line sources, community and other air-pollutant emitting industries) near the WTE plant, the results of both the Austal2000 and AERMOD models are generally acceptable and can be seen as below TA Luft and USEPA Standards. However, it is highly recommended to conduct a validation run after 1 to 3 months during operations stage using actual CEMS, stack testing, and ambient air monitoring results.

---

<sup>15</sup> WHO Best Practices in Incineration, EPA (1990), UNDP (2003), and De Montfort literature.

## 12. RECOMMENDED AMBIENT AIR QUALITY MONITORING STATIONS

Recommended to put up addition Monitoring stations in the ASR 2, ASR 3 and ASR 5 areas. Below is the receptor map of with identified Area Sensitive Receptor primary impact areas and location of Existing Ambient Air Quality Monitoring Stations . In cases of exceedance, these areas are likely to be affected.



Figure 58: Recommended monitoring sites.

## ANNEXES

### ANNEX-1: WHO Best Practice in WTE plant - Recommended Operating Parameters

Table 2 Recommendations of key design/operating parameters for small-scale intermittent incinerators.

Derived in part from EPA (1990), UNDP (2003), and De Montfort literature.

<i>Type</i>	<i>Parameter</i>	<i>Recommendation</i>
Capacity	Destruction rate, safety boxes capacity	District/subdistricts in Taylor (2003) that regularly used incinerators destroyed an average of 58 safety boxes per month, about 14 per week, equivalent to ~12 kg/week. Remote areas may only generate 1 kg per month. Proper sizing is important. Ideally, unit should burn for long periods (~4 hrs) to save fuel. (De Montfort units are not suitable for short sharp burns without a warm up period, though this appears to be common practice).
Temperatures	Primary chamber	540 to 980 C
	Secondary chamber	980 to 1200 C (EPA 1990 recommendations) >850/1100* C (S. African and EU standards) >1000/1100* C (Indian and Thai standards) * more than 1% chlorinated organic matter in waste
	Gas entering air pollution control devices, if any	<230 C
Residence times	Gas (secondary chamber)	>1 s
Air flows	Total combustion air	140 – 200% excess
	Supply and distribution of air in the incinerator	Adequate
	Mixing of combustion gas and air in all zones	Good mixing
	Particulate matter entrainment into flue gas leaving the incinerator	Minimize by keeping moderate air velocity to avoid fluidization of the waste, especially if high (>2%) ash waste is burned.
Controls & Monitoring	Temperature and many other parameters	Continuous for some, periodic for others
Waste	Waste destruction efficiency	>90% by weight
	Uniform waste feed Minimizing emissions of HCl, D/F, metals, other pollutants	Uniform waste feed, and avoid overloading the incinerator Avoid plastics that contain chlorine (polyvinyl chloride products, e.g., blood bags, IV bags, IV tubes, etc. Avoid heavy metals, e.g., mercury from broken thermometers etc.
	Load/charge only when incinerator operating conditions are appropriate	Pre-heat incinerator and ensure temperatures above 800 C. Avoid overheating.
Enclosure	Roof	A roof may be fitted to protect the operator from rain, but only minimum walls.
Chimney	Height	At least 4 – 5 m high, needed for both adequate dispersion plus draft for proper air flow
Pollution control equipment	Installing air pollution control devices (APCD)	Most frequently used controls include packed bed, venturi or other wet scrubbers, fabric filter typically used with a dry injection system, and infrequently electrostatic precipitator (ESP). Modern emission limits cannot be met without APCD.

## ANNEX-2: WHO Best Practice in WTE plant - Typical Maintenance Schedule for Incinerators

Table 4. Typical maintenance schedule for incinerators (derived in part from EPA 1990).

<i>Activity Frequency</i>	<i>Component</i>	<i>Procedure</i>
Hourly	Ash removal	Inspect and clean as required
Daily	Temperature, pollution monitors, if any	Check operation
	Underfire air ports	Inspect and clean as required
	Door seals	Inspect for wear, closeness of fit, air leakage
Weekly	Ash pit	Clean after each shift
	Latches, hinges, wheels, etc.	Lubricate if applicable
Monthly	External surfaces of incinerator and chimney (stack)	Inspect external hot surfaces. White spots or discoloration may indicate loss of refractory
	Refractory	Inspect and repair minor wear with refractory cement
	Upper/secondary combustion chamber	Inspect and remove particulate matter accumulated on chamber floor
Semi-annually	Hot external surfaces	Inspect and paint with high temperature paint as required
	Ambient external surfaces	Inspect and paint as required

### ANNEX 3: MALDIVES MM5 2018 METEROLOGICAL DATA SCREENSHOT PROFILE MET DATA

	Year	Month	Day	Hour	Measurement Height [m]	1, if this is the last (highest) level for this hour, or 0 otherwise	Direction the wind is blowing from for the current level [degrees]	Wind Speed for the current level [m/s]	Temperature at the current level [C]	Standard deviation of the wind direction fluctuations [degrees]	Standard deviation of the vertical wind speed fluctuations [m/s]
Min.	2018	Jan	1	1	10.0	1	0.0	0.00	24.4	99.0	99.00
Max.	2018	Dec	31	24	10.0	1	360.0	14.90	30.6	99.0	99.00
Graph					<input type="checkbox"/>	<input type="checkbox"/>	<input type="checkbox"/>	<input type="checkbox"/>	<input checked="" type="checkbox"/>	<input type="checkbox"/>	<input type="checkbox"/>
1	2018	Jan	1	1	10.0	1	41.0	7.20	28.1	99.0	99.00
2	2018	Jan	1	2	10.0	1	38.0	6.70	27.9	99.0	99.00
3	2018	Jan	1	3	10.0	1	44.0	6.20	27.9	99.0	99.00
4	2018	Jan	1	4	10.0	1	43.0	6.70	28.0	99.0	99.00
5	2018	Jan	1	5	10.0	1	63.0	4.60	27.4	99.0	99.00
6	2018	Jan	1	6	10.0	1	62.0	4.60	27.2	99.0	99.00
7	2018	Jan	1	7	10.0	1	65.0	5.10	27.2	99.0	99.00
8	2018	Jan	1	8	10.0	1	63.0	5.10	27.4	99.0	99.00
9	2018	Jan	1	9	10.0	1	47.0	5.10	27.5	99.0	99.00
10	2018	Jan	1	10	10.0	1	51.0	4.60	27.5	99.0	99.00
11	2018	Jan	1	11	10.0	1	54.0	4.60	27.6	99.0	99.00
12	2018	Jan	1	12	10.0	1	46.0	4.60	27.6	99.0	99.00
13	2018	Jan	1	13	10.0	1	53.0	4.10	27.6	99.0	99.00
14	2018	Jan	1	14	10.0	1	49.0	4.10	27.6	99.0	99.00
15	2018	Jan	1	15	10.0	1	52.0	4.10	27.6	99.0	99.00
16	2018	Jan	1	16	10.0	1	54.0	4.10	27.6	99.0	99.00
17	2018	Jan	1	17	10.0	1	61.0	4.10	27.6	99.0	99.00
18	2018	Jan	1	18	10.0	1	57.0	4.10	27.5	99.0	99.00

### ANNEX 4: MALDIVES MM5 2018 METEROLOGICAL DATA SCREENSHOT SURFACE MET DATA)

	Year	Month	Day	Julian Day	Hour	Surface Roughness Length [m]	Bowen Ratio	Albedo	Wind Speed - Ws [m/s]	Wind Direction - Wd [degrees]	Reference Height for Ws and Wd [m]	Temperature - temp [K]	Reference Height for temp [m]	Precipitation Code	Precipitation Rate [mm/hr]	Relative Humidity [%]	Surface Pressure [mb]	Cloud Cover [tenths]	Data Flag
Min.	2018	Jan	1	1	1	0.000	0.45	0.14	0.00	0.0	10.0	297.5	2.0	0	0.00	57.0	1004.0	2	
Max.	2018	Dec	31	365	24	0.000	0.45	1.00	14.90	360.0	10.0	303.8	2.0	11	48.01	98.0	1015.0	10	
Graph						<input checked="" type="checkbox"/>	<input checked="" type="checkbox"/>	<input checked="" type="checkbox"/>	<input checked="" type="checkbox"/>	<input checked="" type="checkbox"/>	<input checked="" type="checkbox"/>	<input checked="" type="checkbox"/>	<input checked="" type="checkbox"/>	<input checked="" type="checkbox"/>	<input checked="" type="checkbox"/>	<input checked="" type="checkbox"/>	<input checked="" type="checkbox"/>	<input checked="" type="checkbox"/>	
1	2018	Jan	1	1	1	0.000	0.45	1.00	7.20	41.0	10.0	301.2	2.0	0	0.00	76.0	1007.0	3	NAD-SFC NoSubs
2	2018	Jan	1	1	2	0.000	0.45	0.58	6.70	38.0	10.0	301.0	2.0	11	0.51	76.0	1007.0	4	NAD-SFC NoSubs
3	2018	Jan	1	1	3	0.000	0.45	0.25	6.20	44.0	10.0	301.0	2.0	11	1.52	76.0	1007.0	10	NAD-SFC NoSubs
4	2018	Jan	1	1	4	0.000	0.45	0.17	6.70	43.0	10.0	301.1	2.0	11	2.54	75.0	1006.0	10	NAD-SFC NoSubs
5	2018	Jan	1	1	5	0.000	0.45	0.15	4.60	63.0	10.0	300.5	2.0	0	0.00	74.0	1007.0	6	NAD-SFC NoSubs
6	2018	Jan	1	1	6	0.000	0.45	0.14	4.60	62.0	10.0	300.4	2.0	0	0.00	74.0	1006.0	6	NAD-SFC NoSubs
7	2018	Jan	1	1	7	0.000	0.45	0.14	5.10	65.0	10.0	300.4	2.0	11	0.51	74.0	1007.0	5	NAD-SFC NoSubs
8	2018	Jan	1	1	8	0.000	0.45	0.14	5.10	63.0	10.0	300.5	2.0	11	0.51	73.0	1008.0	4	NAD-SFC NoSubs
9	2018	Jan	1	1	9	0.000	0.45	0.14	5.10	47.0	10.0	300.6	2.0	0	0.00	73.0	1008.0	4	NAD-SFC NoSubs
10	2018	Jan	1	1	10	0.000	0.45	0.15	4.60	51.0	10.0	300.6	2.0	0	0.00	72.0	1008.0	3	NAD-SFC NoSubs
11	2018	Jan	1	1	11	0.000	0.45	0.16	4.60	54.0	10.0	300.8	2.0	0	0.00	72.0	1009.0	3	NAD-SFC NoSubs
12	2018	Jan	1	1	12	0.000	0.45	0.21	4.60	46.0	10.0	300.8	2.0	0	0.00	72.0	1009.0	3	NAD-SFC NoSubs

**ANNEX 5: AERMOD VER. 9.7 SAMPLE PLOT FILES**

AERMOD (180)											
AERMET (180)	81):										
MODELING OPT	IONS USED: R	egDFAULT CONC	DEPOS ELEV	DRYDPL T	WETDPL T	RURAL					
PLOT	FILE OF HIGH	1ST HIGH 1-HR	VALUES FOR	SOURCE GR	OUP: ALL						
FOR	A TOTAL OF 16	81 RECEPTORS.									
FORM	AT: (2(1X,F13	.5),2(1X,F13.6)	,3(1X,F8.2),3	X,A6,2X,A	8,2X,A5,5	X,A8,2X,I8)					
X	Y	AVERAGE CONC	TOTAL DEPO	ZELEV	ZHILL	ZFLA G	AVE	GRP	RANK	NET ID	DATE(CO NC)
_____	_____	_____	_____	_____	_____	_____	_____	_____	_____	_____	_____
324540	460472	2.374824	0.000061	0	0	0	1-HR	ALL	1ST	UCAR T1	18021517
324640	460472	2.413572	0.000074	0	0	0	1-HR	ALL	1ST	UCAR T1	18021517
324740	460472	2.535744	0.000076	0	0	0	1-HR	ALL	1ST	UCAR T1	18031323
324840	460472	2.589547	0.000065	0	0	0	1-HR	ALL	1ST	UCAR T1	18111222
324940	460472	2.466475	0.000078	0	0	0	1-HR	ALL	1ST	UCAR T1	18031324
325040	460472	2.622971	0.000079	0	0	0	1-HR	ALL	1ST	UCAR T1	18112713
325140	460472	2.901938	0.000083	0	0	0	1-HR	ALL	1ST	UCAR T1	18021524
325240	460472	2.66411	0.000101	0	0	0	1-HR	ALL	1ST	UCAR T1	18021524



325340	460472	2.219997	0.00015	0	0	0	1-HR	ALL	1ST	UCAR T1	18102613
325440	460472	2.410293	0.00017	0	0	0	1-HR	ALL	1ST	UCAR T1	18102613
325540	460472	2.662954	0.000126	0	0	0	1-HR	ALL	1ST	UCAR T1	18012416
325640	460472	2.867137	0.000093	0	0	0	1-HR	ALL	1ST	UCAR T1	18031218
325740	460472	3.040216	0.000094	0	0	0	1-HR	ALL	1ST	UCAR T1	18031217
325840	460472	2.76666	0.000223	0	0	0	1-HR	ALL	1ST	UCAR T1	18102616
325940	460472	2.807048	0.000162	0	0	0	1-HR	ALL	1ST	UCAR T1	18102616
326040	460472	2.668708	0.000167	0	0	0	1-HR	ALL	1ST	UCAR T1	18012415
326140	460472	2.95032	0.000173	0	0	0	1-HR	ALL	1ST	UCAR T1	18012415
326240	460472	3.06731	0.000149	0	0	0	1-HR	ALL	1ST	UCAR T1	18111219
326340	460472	3.149194	0.000123	0	0	0	1-HR	ALL	1ST	UCAR T1	18111219
326440	460472	2.075674	0.000085	0	0	0	1-HR	ALL	1ST	UCAR T1	18032922
326540	460472	2.448601	0.000051	0	0	0	1-HR	ALL	1ST	UCAR T1	18111224
326640	460472	2.860178	0.000142	0	0	0	1-HR	ALL	1ST	UCAR T1	18032921
326740	460472	2.584067	0.000191	0	0	0	1-HR	ALL	1ST	UCAR T1	18102614
326840	460472	2.123774	0.000092	0	0	0	1-HR	ALL	1ST	UCAR T1	18102614
326940	460472	0.969399	0.000063	0	0	0	1-HR	ALL	1ST	UCAR T1	18022415

AERMOD DISPERSION MODEL VALIDATION STUDY SEPTEMBER 2019  
 Greater Male' Waste to Energy Project  
 Environmental Impact Assessment (EIA) for the Waste to Energy Facility in Thilafushi Island, Maldives

327040	460472	2.054241	0.000155	0	0	0	1-HR	ALL	1ST	UCAR T1	18100221
327140	460472	2.794409	0.000186	0	0	0	1-HR	ALL	1ST	UCAR T1	18031523
327240	460472	1.988173	0.000189	0	0	0	1-HR	ALL	1ST	UCAR T1	18031601
327340	460472	2.513959	0.00022	0	0	0	1-HR	ALL	1ST	UCAR T1	18031524
327440	460472	2.689533	0.000178	0	0	0	1-HR	ALL	1ST	UCAR T1	18031522
327540	460472	2.526455	0.000121	0	0	0	1-HR	ALL	1ST	UCAR T1	18031522
327640	460472	3.289062	0.000072	0	0	0	1-HR	ALL	1ST	UCAR T1	18120613
327740	460472	2.698515	0.000119	0	0	0	1-HR	ALL	1ST	UCAR T1	18112124
327840	460472	2.282734	0.00014	0	0	0	1-HR	ALL	1ST	UCAR T1	18112124
327940	460472	2.398733	0.000118	0	0	0	1-HR	ALL	1ST	UCAR T1	18112124
328040	460472	2.661739	0.000073	0	0	0	1-HR	ALL	1ST	UCAR T1	18112124
328140	460472	2.28584	0.000087	0	0	0	1-HR	ALL	1ST	UCAR T1	18120315
328240	460472	2.167104	0.000098	0	0	0	1-HR	ALL	1ST	UCAR T1	18111218
328340	460472	2.358745	0.000126	0	0	0	1-HR	ALL	1ST	UCAR T1	18111218
328440	460472	2.439526	0.000125	0	0	0	1-HR	ALL	1ST	UCAR T1	18120316
328540	460472	2.830803	0.000116	0	0	0	1-HR	ALL	1ST	UCAR T1	18120316
324540	460572	2.476907	0.000044	0	0	0	1-HR	ALL	1ST	UCAR T1	18032015

AERMOD DISPERSION MODEL VALIDATION STUDY SEPTEMBER 2019  
 Greater Male' Waste to Energy Project  
 Environmental Impact Assessment (EIA) for the Waste to Energy Facility in Thilafushi Island, Maldives

324640	460572	2.411789	0.000064	0	0	0	1-HR	ALL	1ST	UCAR T1	18021517
324740	460572	2.473296	0.000078	0	0	0	1-HR	ALL	1ST	UCAR T1	18031323
324840	460572	2.536927	0.000079	0	0	0	1-HR	ALL	1ST	UCAR T1	18031323
324940	460572	2.675003	0.00007	0	0	0	1-HR	ALL	1ST	UCAR T1	18112713
325040	460572	2.611885	0.000084	0	0	0	1-HR	ALL	1ST	UCAR T1	18112713
325140	460572	2.544284	0.000085	0	0	0	1-HR	ALL	1ST	UCAR T1	18112713
325240	460572	3.066763	0.000102	0	0	0	1-HR	ALL	1ST	UCAR T1	18021524
325340	460572	2.490947	0.000105	0	0	0	1-HR	ALL	1ST	UCAR T1	18021402
325440	460572	2.170551	0.000188	0	0	0	1-HR	ALL	1ST	UCAR T1	18102613
325540	460572	2.697089	0.000145	0	0	0	1-HR	ALL	1ST	UCAR T1	18012416
325640	460572	2.774787	0.0001	0	0	0	1-HR	ALL	1ST	UCAR T1	18012416
325740	460572	2.751654	0.000089	0	0	0	1-HR	ALL	1ST	UCAR T1	18031217
325840	460572	2.843775	0.000191	0	0	0	1-HR	ALL	1ST	UCAR T1	18102616
325940	460572	3.012101	0.000225	0	0	0	1-HR	ALL	1ST	UCAR T1	18102616
326040	460572	2.968065	0.000143	0	0	0	1-HR	ALL	1ST	UCAR T1	18012415
326140	460572	3.113224	0.000206	0	0	0	1-HR	ALL	1ST	UCAR T1	18012415
326240	460572	3.126203	0.000149	0	0	0	1-HR	ALL	1ST	UCAR T1	18111219

AERMOD DISPERSION MODEL VALIDATION STUDY SEPTEMBER 2019  
 Greater Male' Waste to Energy Project  
 Environmental Impact Assessment (EIA) for the Waste to Energy Facility in Thilafushi Island, Maldives

326340	460572	3.323759	0.000141	0	0	0	1-HR	ALL	1ST	UCAR T1	18111219
326440	460572	2.277121	0.000095	0	0	0	1-HR	ALL	1ST	UCAR T1	18032922
326540	460572	2.570275	0.000053	0	0	0	1-HR	ALL	1ST	UCAR T1	18111224
326640	460572	2.979753	0.000158	0	0	0	1-HR	ALL	1ST	UCAR T1	18032921
326740	460572	2.753826	0.0002	0	0	0	1-HR	ALL	1ST	UCAR T1	18102614
326840	460572	2.027717	0.000081	0	0	0	1-HR	ALL	1ST	UCAR T1	18102614
326940	460572	1.169945	0.000089	0	0	0	1-HR	ALL	1ST	UCAR T1	18100221
327040	460572	2.460832	0.00018	0	0	0	1-HR	ALL	1ST	UCAR T1	18031523
327140	460572	2.654439	0.000192	0	0	0	1-HR	ALL	1ST	UCAR T1	18102615
327240	460572	2.327265	0.000193	0	0	0	1-HR	ALL	1ST	UCAR T1	18031601
327340	460572	2.500134	0.000232	0	0	0	1-HR	ALL	1ST	UCAR T1	18031524
327440	460572	2.615254	0.000175	0	0	0	1-HR	ALL	1ST	UCAR T1	18031522
327540	460572	3.02735	0.000084	0	0	0	1-HR	ALL	1ST	UCAR T1	18031522
327640	460572	3.252858	0.000108	0	0	0	1-HR	ALL	1ST	UCAR T1	18112124
327740	460572	2.325895	0.000148	0	0	0	1-HR	ALL	1ST	UCAR T1	18112124
327840	460572	2.51069	0.000139	0	0	0	1-HR	ALL	1ST	UCAR T1	18112124
327940	460572	2.685712	0.000093	0	0	0	1-HR	ALL	1ST	UCAR T1	18112124

AERMOD DISPERSION MODEL VALIDATION STUDY SEPTEMBER 2019  
 Greater Male' Waste to Energy Project  
 Environmental Impact Assessment (EIA) for the Waste to Energy Facility in Thilafushi Island, Maldives

328040	460572	2.535751	0.000087	0	0	0	1-HR	ALL	1ST	UCAR T1	18120315
328140	460572	2.19849	0.000096	0	0	0	1-HR	ALL	1ST	UCAR T1	18111218
328240	460572	2.320417	0.000134	0	0	0	1-HR	ALL	1ST	UCAR T1	18111218
328340	460572	2.483393	0.000133	0	0	0	1-HR	ALL	1ST	UCAR T1	18120316
328440	460572	2.867275	0.000125	0	0	0	1-HR	ALL	1ST	UCAR T1	18120316
328540	460572	3.013515	0.000089	0	0	0	1-HR	ALL	1ST	UCAR T1	18120316
324540	460672	2.480257	0.000076	0	0	0	1-HR	ALL	1ST	UCAR T1	18111220
324640	460672	2.544249	0.000049	0	0	0	1-HR	ALL	1ST	UCAR T1	18032015
324740	460672	2.441197	0.000067	0	0	0	1-HR	ALL	1ST	UCAR T1	18021517
324840	460672	2.525983	0.000083	0	0	0	1-HR	ALL	1ST	UCAR T1	18031323
324940	460672	2.567781	0.000082	0	0	0	1-HR	ALL	1ST	UCAR T1	18031323
325040	460672	2.736948	0.00008	0	0	0	1-HR	ALL	1ST	UCAR T1	18112713
325140	460672	2.777259	0.000093	0	0	0	1-HR	ALL	1ST	UCAR T1	18112713
325240	460672	2.819911	0.00009	0	0	0	1-HR	ALL	1ST	UCAR T1	18112713
325340	460672	3.089893	0.000115	0	0	0	1-HR	ALL	1ST	UCAR T1	18021524
325440	460672	2.320247	0.000151	0	0	0	1-HR	ALL	1ST	UCAR T1	18102613
325540	460672	2.249166	0.000204	0	0	0	1-HR	ALL	1ST	UCAR T1	18102613

AERMOD DISPERSION MODEL VALIDATION STUDY SEPTEMBER 2019  
 Greater Male' Waste to Energy Project  
 Environmental Impact Assessment (EIA) for the Waste to Energy Facility in Thilafushi Island, Maldives

325640	460672	2.850349	0.000144	0	0	0	1-HR	ALL	1ST	UCAR T1	18012416
325740	460672	2.921606	0.000101	0	0	0	1-HR	ALL	1ST	UCAR T1	18031218
325840	460672	3.140232	0.000134	0	0	0	1-HR	ALL	1ST	UCAR T1	18102616
325940	460672	2.997056	0.00027	0	0	0	1-HR	ALL	1ST	UCAR T1	18102616
326040	460672	3.068161	0.000134	0	0	0	1-HR	ALL	1ST	UCAR T1	18120801
326140	460672	3.236382	0.000229	0	0	0	1-HR	ALL	1ST	UCAR T1	18012415
326240	460672	3.094962	0.000143	0	0	0	1-HR	ALL	1ST	UCAR T1	18111219
326340	460672	3.462126	0.00016	0	0	0	1-HR	ALL	1ST	UCAR T1	18111219
326440	460672	2.497472	0.000106	0	0	0	1-HR	ALL	1ST	UCAR T1	18032922
326540	460672	2.699874	0.000056	0	0	0	1-HR	ALL	1ST	UCAR T1	18092804
326640	460672	3.09835	0.000176	0	0	0	1-HR	ALL	1ST	UCAR T1	18032921
326740	460672	2.914469	0.000207	0	0	0	1-HR	ALL	1ST	UCAR T1	18102614
326840	460672	1.882312	0.000074	0	0	0	1-HR	ALL	1ST	UCAR T1	18021521
326940	460672	1.358637	0.000125	0	0	0	1-HR	ALL	1ST	UCAR T1	18100221
327040	460672	2.794293	0.000216	0	0	0	1-HR	ALL	1ST	UCAR T1	18031523
327140	460672	2.29268	0.000214	0	0	0	1-HR	ALL	1ST	UCAR T1	18031601
327240	460672	2.497904	0.000243	0	0	0	1-HR	ALL	1ST	UCAR T1	18031524

327340	460672	2.896369	0.000217	0	0	0	1-HR	ALL	1ST	UCAR T1	18012414
327440	460672	2.792391	0.000145	0	0	0	1-HR	ALL	1ST	UCAR T1	18031522
327540	460672	3.491811	0.000092	0	0	0	1-HR	ALL	1ST	UCAR T1	18112124
327640	460672	2.561642	0.000149	0	0	0	1-HR	ALL	1ST	UCAR T1	18112124
327740	460672	2.455956	0.00016	0	0	0	1-HR	ALL	1ST	UCAR T1	18112124
327840	460672	2.704715	0.000117	0	0	0	1-HR	ALL	1ST	UCAR T1	18112124
327940	460672	2.768546	0.000083	0	0	0	1-HR	ALL	1ST	UCAR T1	18120315
328040	460672	2.241863	0.000092	0	0	0	1-HR	ALL	1ST	UCAR T1	18111218
328140	460672	2.367794	0.000142	0	0	0	1-HR	ALL	1ST	UCAR T1	18111218
328240	460672	2.516468	0.000143	0	0	0	1-HR	ALL	1ST	UCAR T1	18120316
328340	460672	2.982914	0.000135	0	0	0	1-HR	ALL	1ST	UCAR T1	18120316
328440	460672	3.119754	0.000095	0	0	0	1-HR	ALL	1ST	UCAR T1	18120316
328540	460672	2.553128	0.000084	0	0	0	1-HR	ALL	1ST	UCAR T1	18042417
324540	460772	2.539268	0.000095	0	0	0	1-HR	ALL	1ST	UCAR T1	18111220
324640	460772	2.562768	0.000084	0	0	0	1-HR	ALL	1ST	UCAR T1	18111220
324740	460772	2.603724	0.000055	0	0	0	1-HR	ALL	1ST	UCAR T1	18111220
324840	460772	2.460538	0.000071	0	0	0	1-HR	ALL	1ST	UCAR T1	18021517

AERMOD DISPERSION MODEL VALIDATION STUDY SEPTEMBER 2019  
 Greater Male' Waste to Energy Project  
 Environmental Impact Assessment (EIA) for the Waste to Energy Facility in Thilafushi Island, Maldives

324940	460772	2.568544	0.000089	0	0	0	1-HR	ALL	1ST	UCAR T1	18031323
325040	460772	2.736606	0.000084	0	0	0	1-HR	ALL	1ST	UCAR T1	18031323
325140	460772	2.764052	0.00009	0	0	0	1-HR	ALL	1ST	UCAR T1	18112713
325240	460772	2.891013	0.000102	0	0	0	1-HR	ALL	1ST	UCAR T1	18112713
325340	460772	3.16679	0.000094	0	0	0	1-HR	ALL	1ST	UCAR T1	18112713
325440	460772	2.915477	0.000117	0	0	0	1-HR	ALL	1ST	UCAR T1	18021524
325540	460772	2.032895	0.000207	0	0	0	1-HR	ALL	1ST	UCAR T1	18102613
325640	460772	2.624634	0.000179	0	0	0	1-HR	ALL	1ST	UCAR T1	18102613
325740	460772	2.862059	0.00011	0	0	0	1-HR	ALL	1ST	UCAR T1	18012416
325840	460772	2.980309	0.000106	0	0	0	1-HR	ALL	1ST	UCAR T1	18031217
325940	460772	2.843978	0.000269	0	0	0	1-HR	ALL	1ST	UCAR T1	18102616
326040	460772	3.147629	0.000188	0	0	0	1-HR	ALL	1ST	UCAR T1	18102616
326140	460772	3.167473	0.000236	0	0	0	1-HR	ALL	1ST	UCAR T1	18012415
326240	460772	3.264755	0.000144	0	0	0	1-HR	ALL	1ST	UCAR T1	18012415
326340	460772	3.543019	0.000181	0	0	0	1-HR	ALL	1ST	UCAR T1	18111219
326440	460772	2.735695	0.000118	0	0	0	1-HR	ALL	1ST	UCAR T1	18032922
326540	460772	2.83701	0.000061	0	0	0	1-HR	ALL	1ST	UCAR T1	18092804



326640	460772	3.212116	0.000196	0	0	0	1-HR	ALL	1ST	UCAR T1	18032921
326740	460772	3.05429	0.00021	0	0	0	1-HR	ALL	1ST	UCAR T1	18102614
326840	460772	1.684929	0.000075	0	0	0	1-HR	ALL	1ST	UCAR T1	18021521
326940	460772	1.663129	0.000163	0	0	0	1-HR	ALL	1ST	UCAR T1	18100221
327040	460772	2.955724	0.000241	0	0	0	1-HR	ALL	1ST	UCAR T1	18031523
327140	460772	1.901688	0.000239	0	0	0	1-HR	ALL	1ST	UCAR T1	18031601
327240	460772	2.474966	0.000287	0	0	0	1-HR	ALL	1ST	UCAR T1	18031524
327340	460772	2.890422	0.000215	0	0	0	1-HR	ALL	1ST	UCAR T1	18031522
327440	460772	3.374517	0.000096	0	0	0	1-HR	ALL	1ST	UCAR T1	18031522
327540	460772	3.260158	0.00014	0	0	0	1-HR	ALL	1ST	UCAR T1	18112124
327640	460772	2.19033	0.000177	0	0	0	1-HR	ALL	1ST	UCAR T1	18112124
327740	460772	2.685471	0.000146	0	0	0	1-HR	ALL	1ST	UCAR T1	18112124
327840	460772	2.954873	0.000083	0	0	0	1-HR	ALL	1ST	UCAR T1	18112124
327940	460772	2.25429	0.000102	0	0	0	1-HR	ALL	1ST	UCAR T1	18120315
328040	460772	2.532223	0.00015	0	0	0	1-HR	ALL	1ST	UCAR T1	18111218
328140	460772	2.54737	0.000153	0	0	0	1-HR	ALL	1ST	UCAR T1	18120316
328240	460772	3.101918	0.000146	0	0	0	1-HR	ALL	1ST	UCAR T1	18120316

AERMOD DISPERSION MODEL VALIDATION STUDY SEPTEMBER 2019  
 Greater Male' Waste to Energy Project  
 Environmental Impact Assessment (EIA) for the Waste to Energy Facility in Thilafushi Island, Maldives

328340	460772	3.225295	0.000101	0	0	0	1-HR	ALL	1ST	UCAR T1	18120316
328440	460772	2.66197	0.000088	0	0	0	1-HR	ALL	1ST	UCAR T1	18042417
328540	460772	3.033928	0.000093	0	0	0	1-HR	ALL	1ST	UCAR T1	18092815
324540	460872	2.47522	0.000083	0	0	0	1-HR	ALL	1ST	UCAR T1	18111220
324640	460872	2.631176	0.000102	0	0	0	1-HR	ALL	1ST	UCAR T1	18111220
324740	460872	2.645015	0.000094	0	0	0	1-HR	ALL	1ST	UCAR T1	18111220
324840	460872	2.6514	0.000062	0	0	0	1-HR	ALL	1ST	UCAR T1	18111220
324940	460872	2.495426	0.000075	0	0	0	1-HR	ALL	1ST	UCAR T1	18021517
325040	460872	2.59702	0.000096	0	0	0	1-HR	ALL	1ST	UCAR T1	18031323
325140	460872	2.904373	0.000086	0	0	0	1-HR	ALL	1ST	UCAR T1	18031323
325240	460872	2.742096	0.000103	0	0	0	1-HR	ALL	1ST	UCAR T1	18112713
325340	460872	2.921093	0.000112	0	0	0	1-HR	ALL	1ST	UCAR T1	18112713
325440	460872	3.408148	0.000116	0	0	0	1-HR	ALL	1ST	UCAR T1	18021524
325540	460872	2.835267	0.000141	0	0	0	1-HR	ALL	1ST	UCAR T1	18102613
325640	460872	2.31975	0.000243	0	0	0	1-HR	ALL	1ST	UCAR T1	18102613
325740	460872	3.026894	0.000165	0	0	0	1-HR	ALL	1ST	UCAR T1	18012416
325840	460872	2.897978	0.000111	0	0	0	1-HR	ALL	1ST	UCAR T1	18031218

AERMOD DISPERSION MODEL VALIDATION STUDY SEPTEMBER 2019  
 Greater Male' Waste to Energy Project  
 Environmental Impact Assessment (EIA) for the Waste to Energy Facility in Thilafushi Island, Maldives

325940	460872	3.060215	0.000214	0	0	0	1-HR	ALL	1ST	UCAR T1	18102616
326040	460872	3.435097	0.000279	0	0	0	1-HR	ALL	1ST	UCAR T1	18102616
326140	460872	2.950693	0.000219	0	0	0	1-HR	ALL	1ST	UCAR T1	18012415
326240	460872	3.322787	0.000198	0	0	0	1-HR	ALL	1ST	UCAR T1	18012415
326340	460872	3.540337	0.000201	0	0	0	1-HR	ALL	1ST	UCAR T1	18111219
326440	460872	2.988556	0.000132	0	0	0	1-HR	ALL	1ST	UCAR T1	18032922
326540	460872	2.980708	0.000065	0	0	0	1-HR	ALL	1ST	UCAR T1	18092804
326640	460872	3.31546	0.000218	0	0	0	1-HR	ALL	1ST	UCAR T1	18032921
326740	460872	3.156816	0.00021	0	0	0	1-HR	ALL	1ST	UCAR T1	18102614
326840	460872	1.438362	0.000072	0	0	0	1-HR	ALL	1ST	UCAR T1	18021521
326940	460872	2.146125	0.000197	0	0	0	1-HR	ALL	1ST	UCAR T1	18031523
327040	460872	2.845	0.000244	0	0	0	1-HR	ALL	1ST	UCAR T1	18031523
327140	460872	2.262851	0.000247	0	0	0	1-HR	ALL	1ST	UCAR T1	18031524
327240	460872	3.056728	0.000267	0	0	0	1-HR	ALL	1ST	UCAR T1	18012414
327340	460872	3.09869	0.000177	0	0	0	1-HR	ALL	1ST	UCAR T1	18031522
327440	460872	3.645706	0.000121	0	0	0	1-HR	ALL	1ST	UCAR T1	18112124
327540	460872	2.323518	0.000185	0	0	0	1-HR	ALL	1ST	UCAR T1	18112124

AERMOD DISPERSION MODEL VALIDATION STUDY SEPTEMBER 2019  
 Greater Male' Waste to Energy Project  
 Environmental Impact Assessment (EIA) for the Waste to Energy Facility in Thilafushi Island, Maldives

327640	460872	2.504975	0.000176	0	0	0	1-HR	ALL	1ST	UCAR T1	18112124
327740	460872	3.05333	0.000109	0	0	0	1-HR	ALL	1ST	UCAR T1	18112124
327840	460872	2.452437	0.000109	0	0	0	1-HR	ALL	1ST	UCAR T1	18120315
327940	460872	2.697457	0.000156	0	0	0	1-HR	ALL	1ST	UCAR T1	18111218
328040	460872	2.641707	0.000165	0	0	0	1-HR	ALL	1ST	UCAR T1	18120316
328140	460872	3.222615	0.000159	0	0	0	1-HR	ALL	1ST	UCAR T1	18120316
328240	460872	3.327254	0.000107	0	0	0	1-HR	ALL	1ST	UCAR T1	18120316
328340	460872	2.763912	0.000092	0	0	0	1-HR	ALL	1ST	UCAR T1	18042417
328440	460872	3.1449	0.000104	0	0	0	1-HR	ALL	1ST	UCAR T1	18092815
328540	460872	2.764726	0.000108	0	0	0	1-HR	ALL	1ST	UCAR T1	18092815
324540	460972	2.560175	0.0001	0	0	0	1-HR	ALL	1ST	UCAR T1	18030514
324640	460972	2.494151	0.000081	0	0	0	1-HR	ALL	1ST	UCAR T1	18111220
324740	460972	2.691251	0.000107	0	0	0	1-HR	ALL	1ST	UCAR T1	18111220
324840	460972	2.704401	0.000104	0	0	0	1-HR	ALL	1ST	UCAR T1	18111220
324940	460972	2.682114	0.000071	0	0	0	1-HR	ALL	1ST	UCAR T1	18111220
325040	460972	2.626936	0.00008	0	0	0	1-HR	ALL	1ST	UCAR T1	18021517
325140	460972	2.6064	0.000103	0	0	0	1-HR	ALL	1ST	UCAR T1	18031323

AERMOD DISPERSION MODEL VALIDATION STUDY SEPTEMBER 2019  
 Greater Male' Waste to Energy Project  
 Environmental Impact Assessment (EIA) for the Waste to Energy Facility in Thilafushi Island, Maldives

325240	460972	3.062609	0.00009	0	0	0	1-HR	ALL	1ST	UCAR T1	18112713
325340	460972	2.749911	0.000117	0	0	0	1-HR	ALL	1ST	UCAR T1	18112713
325440	460972	2.857044	0.000121	0	0	0	1-HR	ALL	1ST	UCAR T1	18112713
325540	460972	3.447838	0.000136	0	0	0	1-HR	ALL	1ST	UCAR T1	18021524
325640	460972	2.489146	0.000218	0	0	0	1-HR	ALL	1ST	UCAR T1	18102613
325740	460972	2.938728	0.000225	0	0	0	1-HR	ALL	1ST	UCAR T1	18102613
325840	460972	2.888626	0.000122	0	0	0	1-HR	ALL	1ST	UCAR T1	18012416
325940	460972	3.264591	0.000129	0	0	0	1-HR	ALL	1ST	UCAR T1	18102616
326040	460972	3.34226	0.000342	0	0	0	1-HR	ALL	1ST	UCAR T1	18102616
326140	460972	3.271353	0.000176	0	0	0	1-HR	ALL	1ST	UCAR T1	18012415
326240	460972	3.31234	0.000258	0	0	0	1-HR	ALL	1ST	UCAR T1	18012415
326340	460972	3.542907	0.000219	0	0	0	1-HR	ALL	1ST	UCAR T1	18111219
326440	460972	3.249185	0.000147	0	0	0	1-HR	ALL	1ST	UCAR T1	18032922
326540	460972	3.129085	0.00007	0	0	0	1-HR	ALL	1ST	UCAR T1	18092804
326640	460972	3.400422	0.000242	0	0	0	1-HR	ALL	1ST	UCAR T1	18032921
326740	460972	3.19997	0.000203	0	0	0	1-HR	ALL	1ST	UCAR T1	18102614
326840	460972	1.153428	0.000092	0	0	0	1-HR	ALL	1ST	UCAR T1	18022415

AERMOD DISPERSION MODEL VALIDATION STUDY SEPTEMBER 2019  
 Greater Male' Waste to Energy Project  
 Environmental Impact Assessment (EIA) for the Waste to Energy Facility in Thilafushi Island, Maldives

326940	460972	2.625634	0.00026	0	0	0	1-HR	ALL	1ST	UCAR T1	18031523
327040	460972	2.426231	0.000276	0	0	0	1-HR	ALL	1ST	UCAR T1	18031601
327140	460972	2.294318	0.000343	0	0	0	1-HR	ALL	1ST	UCAR T1	18031524
327240	460972	3.166153	0.000267	0	0	0	1-HR	ALL	1ST	UCAR T1	18031522
327340	460972	3.774293	0.000111	0	0	0	1-HR	ALL	1ST	UCAR T1	18031522
327440	460972	3.125776	0.000181	0	0	0	1-HR	ALL	1ST	UCAR T1	18112124
327540	460972	2.309048	0.000206	0	0	0	1-HR	ALL	1ST	UCAR T1	18112124
327640	460972	3.012108	0.000143	0	0	0	1-HR	ALL	1ST	UCAR T1	18112124
327740	460972	2.775257	0.000114	0	0	0	1-HR	ALL	1ST	UCAR T1	18120315
327840	460972	2.854705	0.000161	0	0	0	1-HR	ALL	1ST	UCAR T1	18111218
327940	460972	2.727822	0.000178	0	0	0	1-HR	ALL	1ST	UCAR T1	18120316
328040	460972	3.342406	0.000173	0	0	0	1-HR	ALL	1ST	UCAR T1	18120316
328140	460972	3.421477	0.000115	0	0	0	1-HR	ALL	1ST	UCAR T1	18120316
328240	460972	2.852763	0.000097	0	0	0	1-HR	ALL	1ST	UCAR T1	18042417
328340	460972	3.218742	0.000115	0	0	0	1-HR	ALL	1ST	UCAR T1	18092815
328440	460972	2.688098	0.000113	0	0	0	1-HR	ALL	1ST	UCAR T1	18092815
328540	460972	2.513606	0.0001	0	0	0	1-HR	ALL	1ST	UCAR T1	18091622

324540	461072	2.583947	0.000088	0	0	0	1-HR	ALL	1ST	UCAR T1	18030514
324640	461072	2.645089	0.000109	0	0	0	1-HR	ALL	1ST	UCAR T1	18030514
324740	461072	2.472379	0.00009	0	0	0	1-HR	ALL	1ST	UCAR T1	18030514
324840	461072	2.704681	0.000112	0	0	0	1-HR	ALL	1ST	UCAR T1	18111220
324940	461072	2.866955	0.000116	0	0	0	1-HR	ALL	1ST	UCAR T1	18111220
325040	461072	2.689177	0.000081	0	0	0	1-HR	ALL	1ST	UCAR T1	18111220
325140	461072	2.76288	0.000085	0	0	0	1-HR	ALL	1ST	UCAR T1	18021517
325240	461072	2.590451	0.000111	0	0	0	1-HR	ALL	1ST	UCAR T1	18031323
325340	461072	3.198165	0.000104	0	0	0	1-HR	ALL	1ST	UCAR T1	18112713
325440	461072	2.962379	0.000132	0	0	0	1-HR	ALL	1ST	UCAR T1	18112713
325540	461072	3.321823	0.000129	0	0	0	1-HR	ALL	1ST	UCAR T1	18112713
325640	461072	3.365326	0.000138	0	0	0	1-HR	ALL	1ST	UCAR T1	18021524
325740	461072	2.411346	0.000286	0	0	0	1-HR	ALL	1ST	UCAR T1	18102613
325840	461072	3.197154	0.000193	0	0	0	1-HR	ALL	1ST	UCAR T1	18012416
325940	461072	3.328123	0.00012	0	0	0	1-HR	ALL	1ST	UCAR T1	18031218
326040	461072	3.366931	0.000328	0	0	0	1-HR	ALL	1ST	UCAR T1	18102616
326140	461072	3.444148	0.000216	0	0	0	1-HR	ALL	1ST	UCAR T1	18102616

AERMOD DISPERSION MODEL VALIDATION STUDY SEPTEMBER 2019  
 Greater Male' Waste to Energy Project  
 Environmental Impact Assessment (EIA) for the Waste to Energy Facility in Thilafushi Island, Maldives

326240	461072	3.644026	0.000309	0	0	0	1-HR	ALL	1ST	UCAR T1	18012415
326340	461072	3.643019	0.000232	0	0	0	1-HR	ALL	1ST	UCAR T1	18111219
326440	461072	3.516124	0.000161	0	0	0	1-HR	ALL	1ST	UCAR T1	18032922
326540	461072	3.27887	0.000077	0	0	0	1-HR	ALL	1ST	UCAR T1	18092804
326640	461072	3.455873	0.000271	0	0	0	1-HR	ALL	1ST	UCAR T1	18102614
326740	461072	3.156096	0.000187	0	0	0	1-HR	ALL	1ST	UCAR T1	18102614
326840	461072	1.152107	0.000136	0	0	0	1-HR	ALL	1ST	UCAR T1	18100221
326940	461072	2.950105	0.000316	0	0	0	1-HR	ALL	1ST	UCAR T1	18031523
327040	461072	1.755145	0.00031	0	0	0	1-HR	ALL	1ST	UCAR T1	18031601
327140	461072	3.101262	0.000357	0	0	0	1-HR	ALL	1ST	UCAR T1	18031524
327240	461072	3.440199	0.00022	0	0	0	1-HR	ALL	1ST	UCAR T1	18031522
327340	461072	3.693376	0.000162	0	0	0	1-HR	ALL	1ST	UCAR T1	18112124
327440	461072	1.965361	0.000229	0	0	0	1-HR	ALL	1ST	UCAR T1	18112124
327540	461072	3.014321	0.000184	0	0	0	1-HR	ALL	1ST	UCAR T1	18112124
327640	461072	3.070119	0.000112	0	0	0	1-HR	ALL	1ST	UCAR T1	18120315
327740	461072	2.989758	0.000162	0	0	0	1-HR	ALL	1ST	UCAR T1	18111218
327840	461072	2.798973	0.000191	0	0	0	1-HR	ALL	1ST	UCAR T1	18120316



AERMOD DISPERSION MODEL VALIDATION STUDY SEPTEMBER 2019  
 Greater Male' Waste to Energy Project  
 Environmental Impact Assessment (EIA) for the Waste to Energy Facility in Thilafushi Island, Maldives

327940	461072	3.457357	0.00019	0	0	0	1-HR	ALL	1ST	UCAR T1	18120316
328040	461072	3.50206	0.000123	0	0	0	1-HR	ALL	1ST	UCAR T1	18120316
328140	461072	2.985164	0.0001	0	0	0	1-HR	ALL	1ST	UCAR T1	18042417
328240	461072	3.238437	0.000126	0	0	0	1-HR	ALL	1ST	UCAR T1	18092815
328340	461072	2.719699	0.000115	0	0	0	1-HR	ALL	1ST	UCAR T1	18092815
328440	461072	2.489054	0.000114	0	0	0	1-HR	ALL	1ST	UCAR T1	18091622
328540	461072	2.692771	0.000101	0	0	0	1-HR	ALL	1ST	UCAR T1	18091622
324540	461172	2.794312	0.000103	0	0	0	1-HR	ALL	1ST	UCAR T1	18022724
324640	461172	2.721636	0.000092	0	0	0	1-HR	ALL	1ST	UCAR T1	18022724
324740	461172	2.674596	0.000113	0	0	0	1-HR	ALL	1ST	UCAR T1	18030514
324840	461172	2.57506	0.000108	0	0	0	1-HR	ALL	1ST	UCAR T1	18030514
324940	461172	2.653719	0.000115	0	0	0	1-HR	ALL	1ST	UCAR T1	18111220
325040	461172	3.031578	0.000129	0	0	0	1-HR	ALL	1ST	UCAR T1	18111220
325140	461172	2.721107	0.000093	0	0	0	1-HR	ALL	1ST	UCAR T1	18111220
325240	461172	2.900208	0.000091	0	0	0	1-HR	ALL	1ST	UCAR T1	18021517
325340	461172	2.638842	0.00012	0	0	0	1-HR	ALL	1ST	UCAR T1	18031323
325440	461172	3.29132	0.000122	0	0	0	1-HR	ALL	1ST	UCAR T1	18112713

AERMOD DISPERSION MODEL VALIDATION STUDY SEPTEMBER 2019  
 Greater Male' Waste to Energy Project  
 Environmental Impact Assessment (EIA) for the Waste to Energy Facility in Thilafushi Island, Maldives

325540	461172	3.093714	0.000149	0	0	0	1-HR	ALL	1ST	UCAR T1	18112713
325640	461172	3.662158	0.000135	0	0	0	1-HR	ALL	1ST	UCAR T1	18112713
325740	461172	3.161389	0.000213	0	0	0	1-HR	ALL	1ST	UCAR T1	18102613
325840	461172	3.272087	0.000288	0	0	0	1-HR	ALL	1ST	UCAR T1	18102613
325940	461172	2.914746	0.000141	0	0	0	1-HR	ALL	1ST	UCAR T1	18031218
326040	461172	3.503338	0.000229	0	0	0	1-HR	ALL	1ST	UCAR T1	18102616
326140	461172	3.847743	0.000355	0	0	0	1-HR	ALL	1ST	UCAR T1	18102616
326240	461172	3.722878	0.000331	0	0	0	1-HR	ALL	1ST	UCAR T1	18012415
326340	461172	3.633456	0.000234	0	0	0	1-HR	ALL	1ST	UCAR T1	18111219
326440	461172	3.789207	0.000175	0	0	0	1-HR	ALL	1ST	UCAR T1	18032922
326540	461172	3.424681	0.000084	0	0	0	1-HR	ALL	1ST	UCAR T1	18092804
326640	461172	3.466598	0.00031	0	0	0	1-HR	ALL	1ST	UCAR T1	18102614
326740	461172	2.994152	0.000163	0	0	0	1-HR	ALL	1ST	UCAR T1	18102614
326840	461172	1.502837	0.000197	0	0	0	1-HR	ALL	1ST	UCAR T1	18100221
326940	461172	2.934707	0.000338	0	0	0	1-HR	ALL	1ST	UCAR T1	18031523
327040	461172	1.886292	0.000378	0	0	0	1-HR	ALL	1ST	UCAR T1	18031524
327140	461172	3.395402	0.000337	0	0	0	1-HR	ALL	1ST	UCAR T1	18031522

AERMOD DISPERSION MODEL VALIDATION STUDY SEPTEMBER 2019  
 Greater Male' Waste to Energy Project  
 Environmental Impact Assessment (EIA) for the Waste to Energy Facility in Thilafushi Island, Maldives

327240	461172	4.213359	0.000128	0	0	0	1-HR	ALL	1ST	UCAR T1	18031522
327340	461172	2.776202	0.000236	0	0	0	1-HR	ALL	1ST	UCAR T1	18112124
327440	461172	2.778081	0.00023	0	0	0	1-HR	ALL	1ST	UCAR T1	18112124
327540	461172	3.277369	0.000127	0	0	0	1-HR	ALL	1ST	UCAR T1	18112124
327640	461172	3.080646	0.00016	0	0	0	1-HR	ALL	1ST	UCAR T1	18111218
327740	461172	2.845496	0.000206	0	0	0	1-HR	ALL	1ST	UCAR T1	18120316
327840	461172	3.561634	0.000209	0	0	0	1-HR	ALL	1ST	UCAR T1	18120316
327940	461172	3.560719	0.000131	0	0	0	1-HR	ALL	1ST	UCAR T1	18120316
328040	461172	3.147541	0.000115	0	0	0	1-HR	ALL	1ST	UCAR T1	18092815
328140	461172	3.183592	0.000137	0	0	0	1-HR	ALL	1ST	UCAR T1	18092815
328240	461172	2.747014	0.000115	0	0	0	1-HR	ALL	1ST	UCAR T1	18092815
328340	461172	2.624304	0.000124	0	0	0	1-HR	ALL	1ST	UCAR T1	18091622
328440	461172	2.964987	0.000089	0	0	0	1-HR	ALL	1ST	UCAR T1	18091622
328540	461172	2.988114	0.000108	0	0	0	1-HR	ALL	1ST	UCAR T1	18052614
324540	461272	2.663327	0.000125	0	0	0	1-HR	ALL	1ST	UCAR T1	18022802
324640	461272	2.686706	0.000119	0	0	0	1-HR	ALL	1ST	UCAR T1	18022802
324740	461272	2.936069	0.000113	0	0	0	1-HR	ALL	1ST	UCAR T1	18022724

AERMOD DISPERSION MODEL VALIDATION STUDY SEPTEMBER 2019  
 Greater Male' Waste to Energy Project  
 Environmental Impact Assessment (EIA) for the Waste to Energy Facility in Thilafushi Island, Maldives

324840	461272	2.714649	0.000109	0	0	0	1-HR	ALL	1ST	UCAR T1	18030514
324940	461272	2.713992	0.000126	0	0	0	1-HR	ALL	1ST	UCAR T1	18030514
325040	461272	2.51912	0.000115	0	0	0	1-HR	ALL	1ST	UCAR T1	18111220
325140	461272	3.157534	0.000142	0	0	0	1-HR	ALL	1ST	UCAR T1	18111220
325240	461272	2.716982	0.000107	0	0	0	1-HR	ALL	1ST	UCAR T1	18111220
325340	461272	3.033793	0.000097	0	0	0	1-HR	ALL	1ST	UCAR T1	18021517
325440	461272	2.702049	0.00013	0	0	0	1-HR	ALL	1ST	UCAR T1	18031323
325540	461272	3.313683	0.000144	0	0	0	1-HR	ALL	1ST	UCAR T1	18112713
325640	461272	3.079727	0.000167	0	0	0	1-HR	ALL	1ST	UCAR T1	18112713
325740	461272	3.709397	0.000165	0	0	0	1-HR	ALL	1ST	UCAR T1	18021524
325840	461272	2.51044	0.000327	0	0	0	1-HR	ALL	1ST	UCAR T1	18102613
325940	461272	3.689148	0.00023	0	0	0	1-HR	ALL	1ST	UCAR T1	18012416
326040	461272	3.852586	0.000142	0	0	0	1-HR	ALL	1ST	UCAR T1	18031217
326140	461272	3.639492	0.000449	0	0	0	1-HR	ALL	1ST	UCAR T1	18102616
326240	461272	3.410879	0.000301	0	0	0	1-HR	ALL	1ST	UCAR T1	18012415
326340	461272	3.386047	0.000221	0	0	0	1-HR	ALL	1ST	UCAR T1	18111219
326440	461272	4.015753	0.000187	0	0	0	1-HR	ALL	1ST	UCAR T1	18032922

AERMOD DISPERSION MODEL VALIDATION STUDY SEPTEMBER 2019  
 Greater Male' Waste to Energy Project  
 Environmental Impact Assessment (EIA) for the Waste to Energy Facility in Thilafushi Island, Maldives

326540	461272	3.557938	0.000092	0	0	0	1-HR	ALL	1ST	UCAR T1	18092804
326640	461272	3.41245	0.000353	0	0	0	1-HR	ALL	1ST	UCAR T1	18102614
326740	461272	2.686232	0.000131	0	0	0	1-HR	ALL	1ST	UCAR T1	18102614
326840	461272	2.046977	0.000289	0	0	0	1-HR	ALL	1ST	UCAR T1	18031523
326940	461272	2.449942	0.000368	0	0	0	1-HR	ALL	1ST	UCAR T1	18031601
327040	461272	2.910581	0.000479	0	0	0	1-HR	ALL	1ST	UCAR T1	18031524
327140	461272	3.790621	0.00028	0	0	0	1-HR	ALL	1ST	UCAR T1	18031522
327240	461272	3.709466	0.00022	0	0	0	1-HR	ALL	1ST	UCAR T1	18112124
327340	461272	2.247166	0.000274	0	0	0	1-HR	ALL	1ST	UCAR T1	18112124
327440	461272	3.307734	0.000175	0	0	0	1-HR	ALL	1ST	UCAR T1	18112124
327540	461272	3.095057	0.000151	0	0	0	1-HR	ALL	1ST	UCAR T1	18111218
327640	461272	3.049309	0.000227	0	0	0	1-HR	ALL	1ST	UCAR T1	18111218
327740	461272	3.646716	0.00023	0	0	0	1-HR	ALL	1ST	UCAR T1	18120316
327840	461272	3.585992	0.00014	0	0	0	1-HR	ALL	1ST	UCAR T1	18120316
327940	461272	3.271646	0.000132	0	0	0	1-HR	ALL	1ST	UCAR T1	18092815
328040	461272	3.031948	0.000147	0	0	0	1-HR	ALL	1ST	UCAR T1	18092815
328140	461272	2.706537	0.000125	0	0	0	1-HR	ALL	1ST	UCAR T1	18091622

AERMOD DISPERSION MODEL VALIDATION STUDY SEPTEMBER 2019  
 Greater Male' Waste to Energy Project  
 Environmental Impact Assessment (EIA) for the Waste to Energy Facility in Thilafushi Island, Maldives

328240	461272	2.943103	0.000124	0	0	0	1-HR	ALL	1ST	UCAR T1	18091622
328340	461272	3.155661	0.000101	0	0	0	1-HR	ALL	1ST	UCAR T1	18052614
328440	461272	3.049507	0.000127	0	0	0	1-HR	ALL	1ST	UCAR T1	18052614
328540	461272	2.68805	0.000138	0	0	0	1-HR	ALL	1ST	UCAR T1	18091621
324540	461372	2.848412	0.000154	0	0	0	1-HR	ALL	1ST	UCAR T1	18102617
324640	461372	2.901839	0.00012	0	0	0	1-HR	ALL	1ST	UCAR T1	18030515
324740	461372	2.719045	0.00014	0	0	0	1-HR	ALL	1ST	UCAR T1	18022802
324840	461372	2.933886	0.000119	0	0	0	1-HR	ALL	1ST	UCAR T1	18022723
324940	461372	2.866593	0.000107	0	0	0	1-HR	ALL	1ST	UCAR T1	18022724
325040	461372	2.839334	0.000138	0	0	0	1-HR	ALL	1ST	UCAR T1	18030514
325140	461372	2.626143	0.000111	0	0	0	1-HR	ALL	1ST	UCAR T1	18030514
325240	461372	3.215836	0.000155	0	0	0	1-HR	ALL	1ST	UCAR T1	18111220
325340	461372	2.965529	0.000125	0	0	0	1-HR	ALL	1ST	UCAR T1	18111220
325440	461372	3.155288	0.000105	0	0	0	1-HR	ALL	1ST	UCAR T1	18021517
325540	461372	2.791993	0.000141	0	0	0	1-HR	ALL	1ST	UCAR T1	18031323
325640	461372	3.22678	0.000169	0	0	0	1-HR	ALL	1ST	UCAR T1	18112713
325740	461372	3.138116	0.000184	0	0	0	1-HR	ALL	1ST	UCAR T1	18112713

AERMOD DISPERSION MODEL VALIDATION STUDY SEPTEMBER 2019  
 Greater Male' Waste to Energy Project  
 Environmental Impact Assessment (EIA) for the Waste to Energy Facility in Thilafushi Island, Maldives

325840	461372	3.78388	0.00018	0	0	0	1-HR	ALL	1ST	UCAR T1	18102613
325940	461372	3.561635	0.000375	0	0	0	1-HR	ALL	1ST	UCAR T1	18102613
326040	461372	3.15762	0.000166	0	0	0	1-HR	ALL	1ST	UCAR T1	18031218
326140	461372	3.94921	0.000398	0	0	0	1-HR	ALL	1ST	UCAR T1	18102616
326240	461372	3.519882	0.00024	0	0	0	1-HR	ALL	1ST	UCAR T1	18102616
326340	461372	3.713269	0.000308	0	0	0	1-HR	ALL	1ST	UCAR T1	18012415
326440	461372	4.144018	0.000233	0	0	0	1-HR	ALL	1ST	UCAR T1	18111219
326540	461372	3.665267	0.000101	0	0	0	1-HR	ALL	1ST	UCAR T1	18092804
326640	461372	3.446556	0.000402	0	0	0	1-HR	ALL	1ST	UCAR T1	18102614
326740	461372	2.221158	0.00011	0	0	0	1-HR	ALL	1ST	UCAR T1	18021521
326840	461372	2.515742	0.000409	0	0	0	1-HR	ALL	1ST	UCAR T1	18031523
326940	461372	1.584086	0.000417	0	0	0	1-HR	ALL	1ST	UCAR T1	18031601
327040	461372	3.474876	0.000434	0	0	0	1-HR	ALL	1ST	UCAR T1	18031522
327140	461372	4.637367	0.000177	0	0	0	1-HR	ALL	1ST	UCAR T1	18112124
327240	461372	2.146378	0.000306	0	0	0	1-HR	ALL	1ST	UCAR T1	18112124
327340	461372	3.184012	0.000237	0	0	0	1-HR	ALL	1ST	UCAR T1	18112124
327440	461372	2.988932	0.000153	0	0	0	1-HR	ALL	1ST	UCAR T1	18120315

AERMOD DISPERSION MODEL VALIDATION STUDY SEPTEMBER 2019  
 Greater Male' Waste to Energy Project  
 Environmental Impact Assessment (EIA) for the Waste to Energy Facility in Thilafushi Island, Maldives

327540	461372	3.317478	0.000254	0	0	0	1-HR	ALL	1ST	UCAR T1	18111218
327640	461372	3.700332	0.000256	0	0	0	1-HR	ALL	1ST	UCAR T1	18120316
327740	461372	3.562322	0.000149	0	0	0	1-HR	ALL	1ST	UCAR T1	18120316
327840	461372	3.330477	0.000152	0	0	0	1-HR	ALL	1ST	UCAR T1	18092815
327940	461372	3.031525	0.000154	0	0	0	1-HR	ALL	1ST	UCAR T1	18092815
328040	461372	2.735686	0.000146	0	0	0	1-HR	ALL	1ST	UCAR T1	18091622
328140	461372	3.297636	0.000112	0	0	0	1-HR	ALL	1ST	UCAR T1	18091622
328240	461372	3.41236	0.000132	0	0	0	1-HR	ALL	1ST	UCAR T1	18052614
328340	461372	2.87434	0.000148	0	0	0	1-HR	ALL	1ST	UCAR T1	18091621
328440	461372	2.798098	0.000173	0	0	0	1-HR	ALL	1ST	UCAR T1	18032920
328540	461372	2.708064	0.000174	0	0	0	1-HR	ALL	1ST	UCAR T1	18032920
324540	461472	2.684232	0.000108	0	0	0	1-HR	ALL	1ST	UCAR T1	18102617
324640	461472	2.787034	0.000163	0	0	0	1-HR	ALL	1ST	UCAR T1	18102617
324740	461472	2.995289	0.000166	0	0	0	1-HR	ALL	1ST	UCAR T1	18102617
324840	461472	2.902575	0.000138	0	0	0	1-HR	ALL	1ST	UCAR T1	18022802
324940	461472	2.708144	0.00015	0	0	0	1-HR	ALL	1ST	UCAR T1	18022802
325040	461472	3.06109	0.000134	0	0	0	1-HR	ALL	1ST	UCAR T1	18022724



AERMOD DISPERSION MODEL VALIDATION STUDY SEPTEMBER 2019  
 Greater Male' Waste to Energy Project  
 Environmental Impact Assessment (EIA) for the Waste to Energy Facility in Thilafushi Island, Maldives

325140	461472	2.856639	0.000139	0	0	0	1-HR	ALL	1ST	UCAR T1	18030514
325240	461472	3.006451	0.000141	0	0	0	1-HR	ALL	1ST	UCAR T1	18030514
325340	461472	3.167422	0.000167	0	0	0	1-HR	ALL	1ST	UCAR T1	18111220
325440	461472	3.233434	0.000147	0	0	0	1-HR	ALL	1ST	UCAR T1	18111220
325540	461472	3.346395	0.000114	0	0	0	1-HR	ALL	1ST	UCAR T1	18021517
325640	461472	2.988235	0.000154	0	0	0	1-HR	ALL	1ST	UCAR T1	18031323
325740	461472	3.272253	0.000199	0	0	0	1-HR	ALL	1ST	UCAR T1	18112713
325840	461472	3.566615	0.000199	0	0	0	1-HR	ALL	1ST	UCAR T1	18112713
325940	461472	3.260438	0.000347	0	0	0	1-HR	ALL	1ST	UCAR T1	18102613
326040	461472	4.226637	0.000282	0	0	0	1-HR	ALL	1ST	UCAR T1	18012416
326140	461472	4.284941	0.00022	0	0	0	1-HR	ALL	1ST	UCAR T1	18102616
326240	461472	4.027754	0.000465	0	0	0	1-HR	ALL	1ST	UCAR T1	18102616
326340	461472	4.295935	0.000434	0	0	0	1-HR	ALL	1ST	UCAR T1	18012415
326440	461472	4.098524	0.000292	0	0	0	1-HR	ALL	1ST	UCAR T1	18111219
326540	461472	3.726227	0.000113	0	0	0	1-HR	ALL	1ST	UCAR T1	18092804
326640	461472	3.686826	0.000451	0	0	0	1-HR	ALL	1ST	UCAR T1	18102614
326740	461472	1.625956	0.000148	0	0	0	1-HR	ALL	1ST	UCAR T1	18022415

326840	461472	2.61544	0.000492	0	0	0	1-HR	ALL	1ST	UCAR T1	18031523
326940	461472	2.322212	0.000604	0	0	0	1-HR	ALL	1ST	UCAR T1	18031524
327040	461472	4.070664	0.000367	0	0	0	1-HR	ALL	1ST	UCAR T1	18031522
327140	461472	3.576185	0.000305	0	0	0	1-HR	ALL	1ST	UCAR T1	18112124
327240	461472	2.853878	0.000311	0	0	0	1-HR	ALL	1ST	UCAR T1	18112124
327340	461472	2.983339	0.000163	0	0	0	1-HR	ALL	1ST	UCAR T1	18120315
327440	461472	3.57084	0.000283	0	0	0	1-HR	ALL	1ST	UCAR T1	18111218
327540	461472	3.7051	0.000286	0	0	0	1-HR	ALL	1ST	UCAR T1	18120316
327640	461472	3.469197	0.000159	0	0	0	1-HR	ALL	1ST	UCAR T1	18120316
327740	461472	3.287827	0.000174	0	0	0	1-HR	ALL	1ST	UCAR T1	18092815
327840	461472	3.088521	0.000157	0	0	0	1-HR	ALL	1ST	UCAR T1	18092815
327940	461472	3.116235	0.000155	0	0	0	1-HR	ALL	1ST	UCAR T1	18091622
328040	461472	3.605968	0.000124	0	0	0	1-HR	ALL	1ST	UCAR T1	18052614
328140	461472	3.3999	0.000154	0	0	0	1-HR	ALL	1ST	UCAR T1	18052614
328240	461472	2.897364	0.000189	0	0	0	1-HR	ALL	1ST	UCAR T1	18032920
328340	461472	2.833632	0.000201	0	0	0	1-HR	ALL	1ST	UCAR T1	18032920
328440	461472	2.759771	0.000173	0	0	0	1-HR	ALL	1ST	UCAR T1	18032920

AERMOD DISPERSION MODEL VALIDATION STUDY SEPTEMBER 2019  
 Greater Male' Waste to Energy Project  
 Environmental Impact Assessment (EIA) for the Waste to Energy Facility in Thilafushi Island, Maldives

328540	461472	2.77564	0.000126	0	0	0	1-HR	ALL	1ST	UCAR T1	18032920
324540	461572	2.690535	0.000154	0	0	0	1-HR	ALL	1ST	UCAR T1	18032016
324640	461572	2.718339	0.000139	0	0	0	1-HR	ALL	1ST	UCAR T1	18032016
324740	461572	2.734883	0.000121	0	0	0	1-HR	ALL	1ST	UCAR T1	18102617
324840	461572	2.846963	0.000186	0	0	0	1-HR	ALL	1ST	UCAR T1	18102617
324940	461572	3.094227	0.000177	0	0	0	1-HR	ALL	1ST	UCAR T1	18102617
325040	461572	2.916759	0.000165	0	0	0	1-HR	ALL	1ST	UCAR T1	18022802
325140	461572	2.924023	0.000149	0	0	0	1-HR	ALL	1ST	UCAR T1	18022802
325240	461572	2.927548	0.000127	0	0	0	1-HR	ALL	1ST	UCAR T1	18022724
325340	461572	3.297885	0.00017	0	0	0	1-HR	ALL	1ST	UCAR T1	18030514
325440	461572	3.076447	0.000174	0	0	0	1-HR	ALL	1ST	UCAR T1	18111220
325540	461572	3.48404	0.000175	0	0	0	1-HR	ALL	1ST	UCAR T1	18111220
325640	461572	3.561589	0.000124	0	0	0	1-HR	ALL	1ST	UCAR T1	18021517
325740	461572	3.330626	0.000166	0	0	0	1-HR	ALL	1ST	UCAR T1	18031323
325840	461572	3.150491	0.000234	0	0	0	1-HR	ALL	1ST	UCAR T1	18112713
325940	461572	3.8707	0.00021	0	0	0	1-HR	ALL	1ST	UCAR T1	18021524
326040	461572	3.637961	0.00049	0	0	0	1-HR	ALL	1ST	UCAR T1	18102613

AERMOD DISPERSION MODEL VALIDATION STUDY SEPTEMBER 2019  
 Greater Male' Waste to Energy Project  
 Environmental Impact Assessment (EIA) for the Waste to Energy Facility in Thilafushi Island, Maldives

326140	461572	3.62532	0.0002	0	0	0	1-HR	ALL	1ST	UCAR T1	18031218
326240	461572	3.847577	0.000618	0	0	0	1-HR	ALL	1ST	UCAR T1	18102616
326340	461572	4.350426	0.000512	0	0	0	1-HR	ALL	1ST	UCAR T1	18012415
326440	461572	3.78429	0.000361	0	0	0	1-HR	ALL	1ST	UCAR T1	18111219
326540	461572	3.710363	0.000127	0	0	0	1-HR	ALL	1ST	UCAR T1	18092804
326640	461572	3.817105	0.000494	0	0	0	1-HR	ALL	1ST	UCAR T1	18102614
326740	461572	1.773742	0.000239	0	0	0	1-HR	ALL	1ST	UCAR T1	18100221
326840	461572	1.997952	0.000516	0	0	0	1-HR	ALL	1ST	UCAR T1	18031601
326940	461572	3.201877	0.00059	0	0	0	1-HR	ALL	1ST	UCAR T1	18031524
327040	461572	4.887821	0.000257	0	0	0	1-HR	ALL	1ST	UCAR T1	18112124
327140	461572	2.058375	0.000385	0	0	0	1-HR	ALL	1ST	UCAR T1	18112124
327240	461572	3.09199	0.00021	0	0	0	1-HR	ALL	1ST	UCAR T1	18112124
327340	461572	3.766795	0.000312	0	0	0	1-HR	ALL	1ST	UCAR T1	18111218
327440	461572	3.63704	0.000323	0	0	0	1-HR	ALL	1ST	UCAR T1	18120316
327540	461572	3.39112	0.000169	0	0	0	1-HR	ALL	1ST	UCAR T1	18120316
327640	461572	3.140613	0.000196	0	0	0	1-HR	ALL	1ST	UCAR T1	18092815
327740	461572	2.968089	0.000172	0	0	0	1-HR	ALL	1ST	UCAR T1	18100207

AERMOD DISPERSION MODEL VALIDATION STUDY SEPTEMBER 2019  
 Greater Male' Waste to Energy Project  
 Environmental Impact Assessment (EIA) for the Waste to Energy Facility in Thilafushi Island, Maldives

327840	461572	3.568068	0.000146	0	0	0	1-HR	ALL	1ST	UCAR T1	18091622
327940	461572	3.865658	0.000167	0	0	0	1-HR	ALL	1ST	UCAR T1	18052614
328040	461572	3.009704	0.000204	0	0	0	1-HR	ALL	1ST	UCAR T1	18032920
328140	461572	2.916022	0.000232	0	0	0	1-HR	ALL	1ST	UCAR T1	18032920
328240	461572	2.968505	0.000205	0	0	0	1-HR	ALL	1ST	UCAR T1	18032920
328340	461572	2.883295	0.000148	0	0	0	1-HR	ALL	1ST	UCAR T1	18032920
328440	461572	2.843538	0.000131	0	0	0	1-HR	ALL	1ST	UCAR T1	18092816
328540	461572	3.061829	0.000149	0	0	0	1-HR	ALL	1ST	UCAR T1	18052617
324540	461672	2.830783	0.000165	0	0	0	1-HR	ALL	1ST	UCAR T1	18112201
324640	461672	2.954643	0.000174	0	0	0	1-HR	ALL	1ST	UCAR T1	18112201
324740	461672	2.708458	0.000169	0	0	0	1-HR	ALL	1ST	UCAR T1	18032016
324840	461672	2.724666	0.000164	0	0	0	1-HR	ALL	1ST	UCAR T1	18032016
324940	461672	2.732386	0.000137	0	0	0	1-HR	ALL	1ST	UCAR T1	18102617
325040	461672	2.845549	0.000214	0	0	0	1-HR	ALL	1ST	UCAR T1	18102617
325140	461672	3.09979	0.000185	0	0	0	1-HR	ALL	1ST	UCAR T1	18102617
325240	461672	2.816048	0.000191	0	0	0	1-HR	ALL	1ST	UCAR T1	18022802
325340	461672	2.979961	0.000165	0	0	0	1-HR	ALL	1ST	UCAR T1	18022724

AERMOD DISPERSION MODEL VALIDATION STUDY SEPTEMBER 2019  
 Greater Male' Waste to Energy Project  
 Environmental Impact Assessment (EIA) for the Waste to Energy Facility in Thilafushi Island, Maldives

325440	461672	3.41964	0.000184	0	0	0	1-HR	ALL	1ST	UCAR T1	18030514
325540	461672	3.405598	0.000173	0	0	0	1-HR	ALL	1ST	UCAR T1	18111220
325640	461672	3.671114	0.000208	0	0	0	1-HR	ALL	1ST	UCAR T1	18111220
325740	461672	3.78706	0.000137	0	0	0	1-HR	ALL	1ST	UCAR T1	18021517
325840	461672	3.670762	0.000202	0	0	0	1-HR	ALL	1ST	UCAR T1	18112713
325940	461672	2.751283	0.000273	0	0	0	1-HR	ALL	1ST	UCAR T1	18112713
326040	461672	3.788665	0.000307	0	0	0	1-HR	ALL	1ST	UCAR T1	18102613
326140	461672	4.66472	0.000364	0	0	0	1-HR	ALL	1ST	UCAR T1	18102613
326240	461672	4.217489	0.000465	0	0	0	1-HR	ALL	1ST	UCAR T1	18102616
326340	461672	3.493022	0.000448	0	0	0	1-HR	ALL	1ST	UCAR T1	18012415
326440	461672	3.117609	0.000427	0	0	0	1-HR	ALL	1ST	UCAR T1	18111219
326540	461672	3.574249	0.000145	0	0	0	1-HR	ALL	1ST	UCAR T1	18092804
326640	461672	3.732817	0.000515	0	0	0	1-HR	ALL	1ST	UCAR T1	18102614
326740	461672	2.099989	0.000457	0	0	0	1-HR	ALL	1ST	UCAR T1	18031523
326840	461672	2.118608	0.000627	0	0	0	1-HR	ALL	1ST	UCAR T1	18031524
326940	461672	4.075929	0.000505	0	0	0	1-HR	ALL	1ST	UCAR T1	18031522
327040	461672	2.913743	0.000428	0	0	0	1-HR	ALL	1ST	UCAR T1	18112124

AERMOD DISPERSION MODEL VALIDATION STUDY SEPTEMBER 2019  
 Greater Male' Waste to Energy Project  
 Environmental Impact Assessment (EIA) for the Waste to Energy Facility in Thilafushi Island, Maldives

327140	461672	2.821286	0.000311	0	0	0	1-HR	ALL	1ST	UCAR T1	18112124
327240	461672	3.82797	0.000337	0	0	0	1-HR	ALL	1ST	UCAR T1	18111218
327340	461672	3.464609	0.000367	0	0	0	1-HR	ALL	1ST	UCAR T1	18120316
327440	461672	3.344396	0.000183	0	0	0	1-HR	ALL	1ST	UCAR T1	18042417
327540	461672	3.02298	0.000217	0	0	0	1-HR	ALL	1ST	UCAR T1	18092815
327640	461672	3.356402	0.000196	0	0	0	1-HR	ALL	1ST	UCAR T1	18091622
327740	461672	4.038115	0.000159	0	0	0	1-HR	ALL	1ST	UCAR T1	18052614
327840	461672	3.654976	0.000212	0	0	0	1-HR	ALL	1ST	UCAR T1	18032920
327940	461672	3.033879	0.000267	0	0	0	1-HR	ALL	1ST	UCAR T1	18032920
328040	461672	3.157748	0.000245	0	0	0	1-HR	ALL	1ST	UCAR T1	18032920
328140	461672	3.069765	0.000176	0	0	0	1-HR	ALL	1ST	UCAR T1	18032920
328240	461672	2.984938	0.000154	0	0	0	1-HR	ALL	1ST	UCAR T1	18052617
328340	461672	3.38978	0.000168	0	0	0	1-HR	ALL	1ST	UCAR T1	18052617
328440	461672	3.433354	0.000136	0	0	0	1-HR	ALL	1ST	UCAR T1	18052617
328540	461672	3.095964	0.000123	0	0	0	1-HR	ALL	1ST	UCAR T1	18111217
324540	461772	2.713112	0.000116	0	0	0	1-HR	ALL	1ST	UCAR T1	18021602
324640	461772	2.634636	0.000144	0	0	0	1-HR	ALL	1ST	UCAR T1	18112201

AERMOD DISPERSION MODEL VALIDATION STUDY SEPTEMBER 2019  
 Greater Male' Waste to Energy Project  
 Environmental Impact Assessment (EIA) for the Waste to Energy Facility in Thilafushi Island, Maldives

324740	461772	2.83799	0.00018	0	0	0	1-HR	ALL	1ST	UCAR T1	18112201
324840	461772	3.161442	0.000203	0	0	0	1-HR	ALL	1ST	UCAR T1	18112201
324940	461772	3.037539	0.0002	0	0	0	1-HR	ALL	1ST	UCAR T1	18112201
325040	461772	2.663762	0.000194	0	0	0	1-HR	ALL	1ST	UCAR T1	18032016
325140	461772	2.66893	0.000157	0	0	0	1-HR	ALL	1ST	UCAR T1	18102617
325240	461772	2.742472	0.000248	0	0	0	1-HR	ALL	1ST	UCAR T1	18102617
325340	461772	2.941234	0.00019	0	0	0	1-HR	ALL	1ST	UCAR T1	18030515
325440	461772	2.583555	0.000205	0	0	0	1-HR	ALL	1ST	UCAR T1	18022802
325540	461772	3.539024	0.00017	0	0	0	1-HR	ALL	1ST	UCAR T1	18030514
325640	461772	3.795032	0.000199	0	0	0	1-HR	ALL	1ST	UCAR T1	18030514
325740	461772	4.021125	0.000247	0	0	0	1-HR	ALL	1ST	UCAR T1	18111220
325840	461772	4.198095	0.000153	0	0	0	1-HR	ALL	1ST	UCAR T1	18021517
325940	461772	3.940774	0.000253	0	0	0	1-HR	ALL	1ST	UCAR T1	18112713
326040	461772	2.590769	0.000313	0	0	0	1-HR	ALL	1ST	UCAR T1	18112713
326140	461772	3.121989	0.000619	0	0	0	1-HR	ALL	1ST	UCAR T1	18102613
326240	461772	3.839298	0.000245	0	0	0	1-HR	ALL	1ST	UCAR T1	18031218
326340	461772	3.321372	0.000632	0	0	0	1-HR	ALL	1ST	UCAR T1	18102616



326440	461772	2.61677	0.000458	0	0	0	1-HR	ALL	1ST	UCAR T1	18111219
326540	461772	3.261298	0.000169	0	0	0	1-HR	ALL	1ST	UCAR T1	18022018
326640	461772	3.296334	0.00049	0	0	0	1-HR	ALL	1ST	UCAR T1	18102614
326740	461772	2.518481	0.000742	0	0	0	1-HR	ALL	1ST	UCAR T1	18031523
326840	461772	2.4835	0.000946	0	0	0	1-HR	ALL	1ST	UCAR T1	18031524
326940	461772	4.56848	0.000391	0	0	0	1-HR	ALL	1ST	UCAR T1	18112124
327040	461772	2.162464	0.000447	0	0	0	1-HR	ALL	1ST	UCAR T1	18112124
327140	461772	3.627039	0.000347	0	0	0	1-HR	ALL	1ST	UCAR T1	18111218
327240	461772	3.149864	0.000423	0	0	0	1-HR	ALL	1ST	UCAR T1	18120316
327340	461772	3.182683	0.000209	0	0	0	1-HR	ALL	1ST	UCAR T1	18092815
327440	461772	2.973755	0.00025	0	0	0	1-HR	ALL	1ST	UCAR T1	18100207
327540	461772	3.912761	0.000217	0	0	0	1-HR	ALL	1ST	UCAR T1	18100207
327640	461772	4.193425	0.000222	0	0	0	1-HR	ALL	1ST	UCAR T1	18052614
327740	461772	2.989057	0.000305	0	0	0	1-HR	ALL	1ST	UCAR T1	18032920
327840	461772	3.284084	0.000297	0	0	0	1-HR	ALL	1ST	UCAR T1	18032920
327940	461772	3.230536	0.000212	0	0	0	1-HR	ALL	1ST	UCAR T1	18032920
328040	461772	3.167109	0.000185	0	0	0	1-HR	ALL	1ST	UCAR T1	18052617

AERMOD DISPERSION MODEL VALIDATION STUDY SEPTEMBER 2019  
 Greater Male' Waste to Energy Project  
 Environmental Impact Assessment (EIA) for the Waste to Energy Facility in Thilafushi Island, Maldives

328140	461772	3.700119	0.000188	0	0	0	1-HR	ALL	1ST	UCAR T1	18052617
328240	461772	3.55947	0.000136	0	0	0	1-HR	ALL	1ST	UCAR T1	18052617
328340	461772	3.259976	0.000144	0	0	0	1-HR	ALL	1ST	UCAR T1	18111217
328440	461772	3.097177	0.000129	0	0	0	1-HR	ALL	1ST	UCAR T1	18111217
328540	461772	3.114778	0.000113	0	0	0	1-HR	ALL	1ST	UCAR T1	18091620
324540	461872	3.344624	0.000121	0	0	0	1-HR	ALL	1ST	UCAR T1	18093014
324640	461872	3.002905	0.000106	0	0	0	1-HR	ALL	1ST	UCAR T1	18093014
324740	461872	2.821874	0.000118	0	0	0	1-HR	ALL	1ST	UCAR T1	18021602
324840	461872	2.733716	0.000138	0	0	0	1-HR	ALL	1ST	UCAR T1	18112201
324940	461872	2.636164	0.000188	0	0	0	1-HR	ALL	1ST	UCAR T1	18112201
325040	461872	3.214793	0.000231	0	0	0	1-HR	ALL	1ST	UCAR T1	18112201
325140	461872	3.310118	0.000244	0	0	0	1-HR	ALL	1ST	UCAR T1	18112201
325240	461872	2.70474	0.000231	0	0	0	1-HR	ALL	1ST	UCAR T1	18032016
325340	461872	2.487811	0.000182	0	0	0	1-HR	ALL	1ST	UCAR T1	18102617
325440	461872	2.6163	0.000291	0	0	0	1-HR	ALL	1ST	UCAR T1	18102617
325540	461872	2.667243	0.000236	0	0	0	1-HR	ALL	1ST	UCAR T1	18022802
325640	461872	3.090224	0.000212	0	0	0	1-HR	ALL	1ST	UCAR T1	18022724

AERMOD DISPERSION MODEL VALIDATION STUDY SEPTEMBER 2019  
 Greater Male' Waste to Energy Project  
 Environmental Impact Assessment (EIA) for the Waste to Energy Facility in Thilafushi Island, Maldives

325740	461872	3.855019	0.000253	0	0	0	1-HR	ALL	1ST	UCAR T1	18030514
325840	461872	4.272326	0.00029	0	0	0	1-HR	ALL	1ST	UCAR T1	18111220
325940	461872	4.629821	0.000171	0	0	0	1-HR	ALL	1ST	UCAR T1	18021517
326040	461872	3.992485	0.000322	0	0	0	1-HR	ALL	1ST	UCAR T1	18112713
326140	461872	3.003901	0.000344	0	0	0	1-HR	ALL	1ST	UCAR T1	18112713
326240	461872	4.519109	0.000562	0	0	0	1-HR	ALL	1ST	UCAR T1	18102613
326340	461872	3.923413	0.000917	0	0	0	1-HR	ALL	1ST	UCAR T1	18102616
326440	461872	3.238281	0.000573	0	0	0	1-HR	ALL	1ST	UCAR T1	18012415
326540	461872	3.142279	0.000205	0	0	0	1-HR	ALL	1ST	UCAR T1	18022018
326640	461872	2.860914	0.000388	0	0	0	1-HR	ALL	1ST	UCAR T1	18102614
326740	461872	2.780521	0.000791	0	0	0	1-HR	ALL	1ST	UCAR T1	18031601
326840	461872	3.361482	0.000745	0	0	0	1-HR	ALL	1ST	UCAR T1	18031522
326940	461872	2.632181	0.000591	0	0	0	1-HR	ALL	1ST	UCAR T1	18112124
327040	461872	2.996062	0.000323	0	0	0	1-HR	ALL	1ST	UCAR T1	18111218
327140	461872	2.849766	0.000496	0	0	0	1-HR	ALL	1ST	UCAR T1	18120316
327240	461872	2.786772	0.000272	0	0	0	1-HR	ALL	1ST	UCAR T1	18100207
327340	461872	3.147803	0.000304	0	0	0	1-HR	ALL	1ST	UCAR T1	18100207

AERMOD DISPERSION MODEL VALIDATION STUDY SEPTEMBER 2019  
 Greater Male' Waste to Energy Project  
 Environmental Impact Assessment (EIA) for the Waste to Energy Facility in Thilafushi Island, Maldives

327440	461872	4.224723	0.000231	0	0	0	1-HR	ALL	1ST	UCAR T1	18100207
327540	461872	3.490216	0.000341	0	0	0	1-HR	ALL	1ST	UCAR T1	18032920
327640	461872	3.264186	0.000365	0	0	0	1-HR	ALL	1ST	UCAR T1	18032920
327740	461872	3.518529	0.00026	0	0	0	1-HR	ALL	1ST	UCAR T1	18032920
327840	461872	3.489378	0.000225	0	0	0	1-HR	ALL	1ST	UCAR T1	18052617
327940	461872	3.92017	0.000206	0	0	0	1-HR	ALL	1ST	UCAR T1	18052617
328040	461872	3.54847	0.000166	0	0	0	1-HR	ALL	1ST	UCAR T1	18111217
328140	461872	3.396024	0.00016	0	0	0	1-HR	ALL	1ST	UCAR T1	18111217
328240	461872	3.386578	0.000136	0	0	0	1-HR	ALL	1ST	UCAR T1	18091620
328340	461872	3.226554	0.000143	0	0	0	1-HR	ALL	1ST	UCAR T1	18112123
328440	461872	2.984058	0.000161	0	0	0	1-HR	ALL	1ST	UCAR T1	18112123
328540	461872	2.793527	0.000154	0	0	0	1-HR	ALL	1ST	UCAR T1	18112123
324540	461972	3.340764	0.000158	0	0	0	1-HR	ALL	1ST	UCAR T1	18093014
324640	461972	3.805896	0.000167	0	0	0	1-HR	ALL	1ST	UCAR T1	18093014
324740	461972	4.10357	0.000168	0	0	0	1-HR	ALL	1ST	UCAR T1	18093014
324840	461972	4.118979	0.00016	0	0	0	1-HR	ALL	1ST	UCAR T1	18093014
324940	461972	3.765362	0.000142	0	0	0	1-HR	ALL	1ST	UCAR T1	18093014

AERMOD DISPERSION MODEL VALIDATION STUDY SEPTEMBER 2019  
 Greater Male' Waste to Energy Project  
 Environmental Impact Assessment (EIA) for the Waste to Energy Facility in Thilafushi Island, Maldives

325040	461972	3.043534	0.000138	0	0	0	1-HR	ALL	1ST	UCAR T1	18021602
325140	461972	2.5881	0.000185	0	0	0	1-HR	ALL	1ST	UCAR T1	18112201
325240	461972	2.965706	0.000253	0	0	0	1-HR	ALL	1ST	UCAR T1	18112201
325340	461972	3.392681	0.000297	0	0	0	1-HR	ALL	1ST	UCAR T1	18112201
325440	461972	2.929884	0.000279	0	0	0	1-HR	ALL	1ST	UCAR T1	18112201
325540	461972	2.045483	0.000215	0	0	0	1-HR	ALL	1ST	UCAR T1	18102617
325640	461972	2.2378	0.000344	0	0	0	1-HR	ALL	1ST	UCAR T1	18102617
325740	461972	2.114096	0.000293	0	0	0	1-HR	ALL	1ST	UCAR T1	18022802
325840	461972	3.924663	0.000257	0	0	0	1-HR	ALL	1ST	UCAR T1	18030514
325940	461972	4.086389	0.000323	0	0	0	1-HR	ALL	1ST	UCAR T1	18111220
326040	461972	4.910912	0.000201	0	0	0	1-HR	ALL	1ST	UCAR T1	18021313
326140	461972	3.549144	0.000416	0	0	0	1-HR	ALL	1ST	UCAR T1	18112713
326240	461972	3.231884	0.000644	0	0	0	1-HR	ALL	1ST	UCAR T1	18102613
326340	461972	3.684668	0.00044	0	0	0	1-HR	ALL	1ST	UCAR T1	18102616
326440	461972	3.378798	0.000941	0	0	0	1-HR	ALL	1ST	UCAR T1	18012415
326540	461972	3.553858	0.000254	0	0	0	1-HR	ALL	1ST	UCAR T1	18022018
326640	461972	3.427309	0.00029	0	0	0	1-HR	ALL	1ST	UCAR T1	18022415

AERMOD DISPERSION MODEL VALIDATION STUDY SEPTEMBER 2019  
 Greater Male' Waste to Energy Project  
 Environmental Impact Assessment (EIA) for the Waste to Energy Facility in Thilafushi Island, Maldives

326740	461972	3.341483	0.001349	0	0	0	1-HR	ALL	1ST	UCAR T1	18031524
326840	461972	3.329937	0.000637	0	0	0	1-HR	ALL	1ST	UCAR T1	18112124
326940	461972	2.933391	0.000406	0	0	0	1-HR	ALL	1ST	UCAR T1	18112124
327040	461972	3.290567	0.000594	0	0	0	1-HR	ALL	1ST	UCAR T1	18120316
327140	461972	2.561495	0.000366	0	0	0	1-HR	ALL	1ST	UCAR T1	18100207
327240	461972	3.734697	0.00036	0	0	0	1-HR	ALL	1ST	UCAR T1	18100207
327340	461972	3.949731	0.000361	0	0	0	1-HR	ALL	1ST	UCAR T1	18032920
327440	461972	2.952322	0.000455	0	0	0	1-HR	ALL	1ST	UCAR T1	18032920
327540	461972	3.832369	0.000327	0	0	0	1-HR	ALL	1ST	UCAR T1	18032920
327640	461972	3.818492	0.000278	0	0	0	1-HR	ALL	1ST	UCAR T1	18052617
327740	461972	3.905491	0.000215	0	0	0	1-HR	ALL	1ST	UCAR T1	18052617
327840	461972	3.839175	0.000201	0	0	0	1-HR	ALL	1ST	UCAR T1	18111217
327940	461972	3.564249	0.000167	1.4	1.4	0	1-HR	ALL	1ST	UCAR T1	18091620
328040	461972	3.406662	0.000175	2.9	2.9	0	1-HR	ALL	1ST	UCAR T1	18112123
328140	461972	3.129019	0.000195	3.6	3.6	0	1-HR	ALL	1ST	UCAR T1	18112123
328240	461972	3.068521	0.000176	1.1	1.1	0	1-HR	ALL	1ST	UCAR T1	18112123
328340	461972	2.992918	0.000182	0	0	0	1-HR	ALL	1ST	UCAR T1	18111214

AERMOD DISPERSION MODEL VALIDATION STUDY SEPTEMBER 2019  
 Greater Male' Waste to Energy Project  
 Environmental Impact Assessment (EIA) for the Waste to Energy Facility in Thilafushi Island, Maldives

328440	461972	3.092727	0.000173	0	0	0	1-HR	ALL	1ST	UCAR T1	18111214
328540	461972	3.047072	0.000145	0	0	0	1-HR	ALL	1ST	UCAR T1	18072401
324540	462072	2.636984	0.000117	0	0	0	1-HR	ALL	1ST	UCAR T1	18021217
324640	462072	2.823361	0.000133	0	0	0	1-HR	ALL	1ST	UCAR T1	18093014
324740	462072	2.903968	0.000159	0	0	0	1-HR	ALL	1ST	UCAR T1	18093014
324840	462072	3.304621	0.000183	0	0	0	1-HR	ALL	1ST	UCAR T1	18093014
324940	462072	4.069228	0.000204	0	0	0	1-HR	ALL	1ST	UCAR T1	18093014
325040	462072	4.711291	0.000217	0	0	0	1-HR	ALL	1ST	UCAR T1	18093014
325140	462072	5.00717	0.000216	0	0	0	1-HR	ALL	1ST	UCAR T1	18093014
325240	462072	4.721908	0.000198	0	0	0	1-HR	ALL	1ST	UCAR T1	18093014
325340	462072	3.762135	0.000167	0	0	0	1-HR	ALL	1ST	UCAR T1	18021602
325440	462072	2.356123	0.000258	0	0	0	1-HR	ALL	1ST	UCAR T1	18112201
325540	462072	3.041605	0.000351	0	0	0	1-HR	ALL	1ST	UCAR T1	18112201
325640	462072	2.907461	0.000371	0	0	0	1-HR	ALL	1ST	UCAR T1	18112201
325740	462072	2.169478	0.000269	0	0	0	1-HR	ALL	1ST	UCAR T1	18112201
325840	462072	2.495052	0.000403	0	0	0	1-HR	ALL	1ST	UCAR T1	18102617
325940	462072	2.786724	0.000302	0	0	0	1-HR	ALL	1ST	UCAR T1	18022802

AERMOD DISPERSION MODEL VALIDATION STUDY SEPTEMBER 2019  
 Greater Male' Waste to Energy Project  
 Environmental Impact Assessment (EIA) for the Waste to Energy Facility in Thilafushi Island, Maldives

326040	462072	4.061162	0.000328	0	0	0	1-HR	ALL	1ST	UCAR T1	18030514
326140	462072	4.713165	0.000279	0	0	0	1-HR	ALL	1ST	UCAR T1	18110706
326240	462072	4.17751	0.000543	0	0	0	1-HR	ALL	1ST	UCAR T1	18112713
326340	462072	3.517662	0.000989	0	0	0	1-HR	ALL	1ST	UCAR T1	18102613
326440	462072	4.204208	0.000861	0	0	0	1-HR	ALL	1ST	UCAR T1	18102616
326540	462072	3.804537	0.000325	0	0	0	1-HR	ALL	1ST	UCAR T1	18022018
326640	462072	3.805752	0.000841	0	0	0	1-HR	ALL	1ST	UCAR T1	18031523
326740	462072	4.080314	0.001265	0	0	0	1-HR	ALL	1ST	UCAR T1	18031522
326840	462072	3.243478	0.000712	0	0	0	1-HR	ALL	1ST	UCAR T1	18112124
326940	462072	3.684804	0.000733	0	0	0	1-HR	ALL	1ST	UCAR T1	18120316
327040	462072	3.302907	0.000509	0	0	0	1-HR	ALL	1ST	UCAR T1	18100207
327140	462072	3.865585	0.000396	0	0	0	1-HR	ALL	1ST	UCAR T1	18100207
327240	462072	3.092219	0.000576	0	0	0	1-HR	ALL	1ST	UCAR T1	18032920
327340	462072	3.922883	0.000425	0	0	0	1-HR	ALL	1ST	UCAR T1	18032920
327440	462072	4.415851	0.000346	0	0	0	1-HR	ALL	1ST	UCAR T1	18052617
327540	462072	4.171352	0.000252	0	0	0	1-HR	ALL	1ST	UCAR T1	18111217
327640	462072	4.204324	0.000217	0	0	0	1-HR	ALL	1ST	UCAR T1	18111217



AERMOD DISPERSION MODEL VALIDATION STUDY SEPTEMBER 2019  
 Greater Male' Waste to Energy Project  
 Environmental Impact Assessment (EIA) for the Waste to Energy Facility in Thilafushi Island, Maldives

327740	462072	3.628047	0.000224	0.9	0.9	0	1-HR	ALL	1ST	UCAR T1	18052616
327840	462072	3.405902	0.000242	1.8	1.8	0	1-HR	ALL	1ST	UCAR T1	18052616
327940	462072	3.412619	0.000222	2.8	2.8	0	1-HR	ALL	1ST	UCAR T1	18111214
328040	462072	3.424001	0.000223	4.2	4.2	0	1-HR	ALL	1ST	UCAR T1	18111214
328140	462072	3.425182	0.000183	4.6	4.6	0	1-HR	ALL	1ST	UCAR T1	18072401
328240	462072	3.339065	0.000143	2.6	2.6	0	1-HR	ALL	1ST	UCAR T1	18072401
328340	462072	3.382671	0.000148	0	0	0	1-HR	ALL	1ST	UCAR T1	18111215
328440	462072	3.243653	0.000163	0	0	0	1-HR	ALL	1ST	UCAR T1	18111215
328540	462072	2.999015	0.000165	0	0	0	1-HR	ALL	1ST	UCAR T1	18111215
324540	462172	2.214796	0.000124	0	0	0	1-HR	ALL	1ST	UCAR T1	18112716
324640	462172	2.42424	0.000119	0	0	0	1-HR	ALL	1ST	UCAR T1	18112716
324740	462172	2.594191	0.000111	0	0	0	1-HR	ALL	1ST	UCAR T1	18112716
324840	462172	2.693795	0.00011	0	0	0	1-HR	ALL	1ST	UCAR T1	18021217
324940	462172	2.687041	0.000132	0	0	0	1-HR	ALL	1ST	UCAR T1	18021217
325040	462172	2.698836	0.000158	0	0	0	1-HR	ALL	1ST	UCAR T1	18093014
325140	462172	2.856463	0.000198	0	0	0	1-HR	ALL	1ST	UCAR T1	18093014
325240	462172	3.736187	0.000239	0	0	0	1-HR	ALL	1ST	UCAR T1	18093014

AERMOD DISPERSION MODEL VALIDATION STUDY SEPTEMBER 2019  
 Greater Male' Waste to Energy Project  
 Environmental Impact Assessment (EIA) for the Waste to Energy Facility in Thilafushi Island, Maldives

325340	462172	4.836926	0.000275	0	0	0	1-HR	ALL	1ST	UCAR T1	18093014
325440	462172	5.657038	0.000296	0	0	0	1-HR	ALL	1ST	UCAR T1	18093014
325540	462172	5.647141	0.000287	0	0	0	1-HR	ALL	1ST	UCAR T1	18093014
325640	462172	4.391776	0.000241	0	0	0	1-HR	ALL	1ST	UCAR T1	18093014
325740	462172	2.500739	0.000386	0	0	0	1-HR	ALL	1ST	UCAR T1	18112201
325840	462172	2.899909	0.000497	0	0	0	1-HR	ALL	1ST	UCAR T1	18112201
325940	462172	2.920056	0.000395	0	0	0	1-HR	ALL	1ST	UCAR T1	18112201
326040	462172	3.253273	0.000443	0	0	0	1-HR	ALL	1ST	UCAR T1	18102617
326140	462172	3.709492	0.000455	0	0	0	1-HR	ALL	1ST	UCAR T1	18030514
326240	462172	4.44481	0.000421	0	0	0	1-HR	ALL	1ST	UCAR T1	18110706
326340	462172	4.574135	0.000699	0	0	0	1-HR	ALL	1ST	UCAR T1	18112713
326440	462172	4.851716	0.001499	0	0	0	1-HR	ALL	1ST	UCAR T1	18102616
326540	462172	4.045455	0.000462	0	0	0	1-HR	ALL	1ST	UCAR T1	18032922
326640	462172	4.418003	0.001804	0	0	0	1-HR	ALL	1ST	UCAR T1	18031523
326740	462172	4.063817	0.001113	0	0	0	1-HR	ALL	1ST	UCAR T1	18112124
326840	462172	3.943677	0.000952	0	0	0	1-HR	ALL	1ST	UCAR T1	18120316
326940	462172	4.161894	0.000717	0	0	0	1-HR	ALL	1ST	UCAR T1	18100207

AERMOD DISPERSION MODEL VALIDATION STUDY SEPTEMBER 2019  
 Greater Male' Waste to Energy Project  
 Environmental Impact Assessment (EIA) for the Waste to Energy Facility in Thilafushi Island, Maldives

327040	462172	4.466715	0.000721	0	0	0	1-HR	ALL	1ST	UCAR T1	18032920
327140	462172	4.004594	0.000582	0	0	0	1-HR	ALL	1ST	UCAR T1	18032920
327240	462172	4.728301	0.000417	0	0	0	1-HR	ALL	1ST	UCAR T1	18052617
327340	462172	4.469405	0.00032	0	0	0	1-HR	ALL	1ST	UCAR T1	18111217
327440	462172	4.440748	0.000305	0	0	0	1-HR	ALL	1ST	UCAR T1	18052616
327540	462172	4.09277	0.00031	0	0	0	1-HR	ALL	1ST	UCAR T1	18052616
327640	462172	3.967098	0.000303	0.4	0.4	0	1-HR	ALL	1ST	UCAR T1	18111214
327740	462172	4.115429	0.000243	2	2	0	1-HR	ALL	1ST	UCAR T1	18111214
327840	462172	3.98929	0.000191	2.9	2.9	0	1-HR	ALL	1ST	UCAR T1	18052619
327940	462172	3.954134	0.00022	3.6	3.6	0	1-HR	ALL	1ST	UCAR T1	18111215
328040	462172	3.644489	0.000223	4	4	0	1-HR	ALL	1ST	UCAR T1	18111215
328140	462172	3.36928	0.000203	3.3	3.3	0	1-HR	ALL	1ST	UCAR T1	18111215
328240	462172	3.405078	0.000181	2.1	2.1	0	1-HR	ALL	1ST	UCAR T1	18072324
328340	462172	3.476626	0.000165	0	0	0	1-HR	ALL	1ST	UCAR T1	18072324
328440	462172	3.398694	0.000145	0	0	0	1-HR	ALL	1ST	UCAR T1	18072324
328540	462172	3.304466	0.000127	0	0	0	1-HR	ALL	1ST	UCAR T1	18072402
324540	462272	3.043054	0.000161	0	0	0	1-HR	ALL	1ST	UCAR T1	18112716

AERMOD DISPERSION MODEL VALIDATION STUDY SEPTEMBER 2019  
 Greater Male' Waste to Energy Project  
 Environmental Impact Assessment (EIA) for the Waste to Energy Facility in Thilafushi Island, Maldives

324640	462272	2.922095	0.000172	0	0	0	1-HR	ALL	1ST	UCAR T1	18112716
324740	462272	2.911094	0.000183	0	0	0	1-HR	ALL	1ST	UCAR T1	18112716
324840	462272	2.918863	0.000193	0	0	0	1-HR	ALL	1ST	UCAR T1	18112716
324940	462272	2.86446	0.000201	0	0	0	1-HR	ALL	1ST	UCAR T1	18112716
325040	462272	2.731706	0.000207	0	0	0	1-HR	ALL	1ST	UCAR T1	18112716
325140	462272	2.506535	0.000208	0	0	0	1-HR	ALL	1ST	UCAR T1	18112716
325240	462272	2.182028	0.000204	0	0	0	1-HR	ALL	1ST	UCAR T1	18112716
325340	462272	2.039593	0.000193	0	0	0	1-HR	ALL	1ST	UCAR T1	18112716
325440	462272	2.196988	0.000181	0	0	0	1-HR	ALL	1ST	UCAR T1	18093014
325540	462272	2.236686	0.000248	0	0	0	1-HR	ALL	1ST	UCAR T1	18093014
325640	462272	3.461634	0.000326	0	0	0	1-HR	ALL	1ST	UCAR T1	18093014
325740	462272	4.789024	0.000402	0	0	0	1-HR	ALL	1ST	UCAR T1	18093014
325840	462272	5.33593	0.000441	0	0	0	1-HR	ALL	1ST	UCAR T1	18093014
325940	462272	3.907814	0.000396	0	0	0	1-HR	ALL	1ST	UCAR T1	18093014
326040	462272	3.854292	0.000643	0	0	0	1-HR	ALL	1ST	UCAR T1	18112201
326140	462272	4.18353	0.000642	0	0	0	1-HR	ALL	1ST	UCAR T1	18112201
326240	462272	4.055788	0.000606	0	0	0	1-HR	ALL	1ST	UCAR T1	18022802

AERMOD DISPERSION MODEL VALIDATION STUDY SEPTEMBER 2019  
 Greater Male' Waste to Energy Project  
 Environmental Impact Assessment (EIA) for the Waste to Energy Facility in Thilafushi Island, Maldives

326340	462272	4.870343	0.000712	0	0	0	1-HR	ALL	1ST	UCAR T1	18110706
326440	462272	4.577863	0.001839	0	0	0	1-HR	ALL	1ST	UCAR T1	18102613
326540	462272	4.583194	0.000782	0	0	0	1-HR	ALL	1ST	UCAR T1	18032922
326640	462272	4.416533	0.002891	0	0	0	1-HR	ALL	1ST	UCAR T1	18031522
326740	462272	4.758894	0.001348	0	0	0	1-HR	ALL	1ST	UCAR T1	18120316
326840	462272	5.080186	0.00091	0	0	0	1-HR	ALL	1ST	UCAR T1	18100207
326940	462272	4.773983	0.000876	0	0	0	1-HR	ALL	1ST	UCAR T1	18032920
327040	462272	4.77884	0.000514	0	0	0	1-HR	ALL	1ST	UCAR T1	18110707
327140	462272	4.561237	0.000464	0	0	0	1-HR	ALL	1ST	UCAR T1	18052616
327240	462272	5.087409	0.000447	0	0	0	1-HR	ALL	1ST	UCAR T1	18111214
327340	462272	5.985767	0.000359	0	0	0	1-HR	ALL	1ST	UCAR T1	18111214
327440	462272	5.408536	0.000323	0	0	0	1-HR	ALL	1ST	UCAR T1	18111215
327540	462272	4.642225	0.000336	0	0	0	1-HR	ALL	1ST	UCAR T1	18111215
327640	462272	4.723612	0.000282	0.1	0.1	0	1-HR	ALL	1ST	UCAR T1	18111215
327740	462272	4.494041	0.000243	0.9	0.9	0	1-HR	ALL	1ST	UCAR T1	18072324
327840	462272	4.503998	0.000202	2.5	2.5	0	1-HR	ALL	1ST	UCAR T1	18072324
327940	462272	4.325898	0.000175	3.1	3.1	0	1-HR	ALL	1ST	UCAR T1	18072402

328040	462272	4.023371	0.00015	3.9	3.9	0	1-HR	ALL	1ST	UCAR T1	18072402
328140	462272	3.66432	0.000131	3.9	3.9	0	1-HR	ALL	1ST	UCAR T1	18111213
328240	462272	3.36074	0.000128	1.1	1.1	0	1-HR	ALL	1ST	UCAR T1	18103113
328340	462272	3.299287	0.000131	0	0	0	1-HR	ALL	1ST	UCAR T1	18103113
328440	462272	3.181022	0.00013	0	0	0	1-HR	ALL	1ST	UCAR T1	18103113
328540	462272	3.071959	0.000129	0	0	0	1-HR	ALL	1ST	UCAR T1	18091618
324540	462372	2.982954	0.000122	0	0	0	1-HR	ALL	1ST	UCAR T1	18112717
324640	462372	3.088388	0.000126	0	0	0	1-HR	ALL	1ST	UCAR T1	18112717
324740	462372	3.18814	0.000128	0	0	0	1-HR	ALL	1ST	UCAR T1	18112717
324840	462372	3.272281	0.000132	0	0	0	1-HR	ALL	1ST	UCAR T1	18112716
324940	462372	3.33335	0.00015	0	0	0	1-HR	ALL	1ST	UCAR T1	18112716
325040	462372	3.361783	0.00017	0	0	0	1-HR	ALL	1ST	UCAR T1	18112716
325140	462372	3.345641	0.000193	0	0	0	1-HR	ALL	1ST	UCAR T1	18112716
325240	462372	3.270585	0.00022	0	0	0	1-HR	ALL	1ST	UCAR T1	18112716
325340	462372	3.1203	0.00025	0	0	0	1-HR	ALL	1ST	UCAR T1	18112716
325440	462372	2.872859	0.000285	0	0	0	1-HR	ALL	1ST	UCAR T1	18112716
325540	462372	2.474883	0.000322	0	0	0	1-HR	ALL	1ST	UCAR T1	18112716

AERMOD DISPERSION MODEL VALIDATION STUDY SEPTEMBER 2019  
 Greater Male' Waste to Energy Project  
 Environmental Impact Assessment (EIA) for the Waste to Energy Facility in Thilafushi Island, Maldives

325640	462372	2.005443	0.000361	0	0	0	1-HR	ALL	1ST	UCAR T1	18112716
325740	462372	2.307391	0.000398	0	0	0	1-HR	ALL	1ST	UCAR T1	18112716
325840	462372	3.018657	0.000425	0	0	0	1-HR	ALL	1ST	UCAR T1	18112716
325940	462372	3.938256	0.000427	0	0	0	1-HR	ALL	1ST	UCAR T1	18112716
326040	462372	4.482422	0.000469	0	0	0	1-HR	ALL	1ST	UCAR T1	18093014
326140	462372	3.884885	0.0007	0	0	0	1-HR	ALL	1ST	UCAR T1	18093014
326240	462372	4.219656	0.000808	0	0	0	1-HR	ALL	1ST	UCAR T1	18093014
326340	462372	4.582338	0.001266	0	0	0	1-HR	ALL	1ST	UCAR T1	18112201
326440	462372	4.842688	0.001564	0	0	0	1-HR	ALL	1ST	UCAR T1	18110706
326540	462372	5.131419	0.002332	0	0	0	1-HR	ALL	1ST	UCAR T1	18012415
326640	462372	4.035594	0.002342	0	0	0	1-HR	ALL	1ST	UCAR T1	18111218
326740	462372	4.835029	0.001715	0	0	0	1-HR	ALL	1ST	UCAR T1	18012413
326840	462372	4.858757	0.000997	0	0	0	1-HR	ALL	1ST	UCAR T1	18110707
326940	462372	5.546797	0.000662	0	0	0	1-HR	ALL	1ST	UCAR T1	18111214
327040	462372	6.081552	0.000647	0	0	0	1-HR	ALL	1ST	UCAR T1	18111215
327140	462372	7.069239	0.000445	0	0	0	1-HR	ALL	1ST	UCAR T1	18072324
327240	462372	6.315023	0.000332	0	0	0	1-HR	ALL	1ST	UCAR T1	18072402

327340	462372	5.068295	0.000266	0	0	0	1-HR	ALL	1ST	UCAR T1	18103113
327440	462372	4.868949	0.000273	0	0	0	1-HR	ALL	1ST	UCAR T1	18103113
327540	462372	4.734964	0.000282	0	0	0	1-HR	ALL	1ST	UCAR T1	18091618
327640	462372	4.448644	0.000281	0	0	0	1-HR	ALL	1ST	UCAR T1	18091618
327740	462372	4.155166	0.000272	0	0	0	1-HR	ALL	1ST	UCAR T1	18091618
327840	462372	3.870409	0.000256	0.8	0.8	0	1-HR	ALL	1ST	UCAR T1	18091618
327940	462372	3.584017	0.000239	2.6	2.6	0	1-HR	ALL	1ST	UCAR T1	18091618
328040	462372	3.355362	0.00022	3.1	3.1	0	1-HR	ALL	1ST	UCAR T1	18091618
328140	462372	3.279608	0.000205	1.3	1.3	0	1-HR	ALL	1ST	UCAR T1	18072323
328240	462372	3.17442	0.000194	0.1	0.1	0	1-HR	ALL	1ST	UCAR T1	18072323
328340	462372	3.077933	0.000184	0	0	0	1-HR	ALL	1ST	UCAR T1	18072323
328440	462372	2.974815	0.000173	0	0	0	1-HR	ALL	1ST	UCAR T1	18072323
328540	462372	2.973436	0.000164	0	0	0	1-HR	ALL	1ST	UCAR T1	18072323
324540	462472	2.764179	0.000134	0	0	0	1-HR	ALL	1ST	UCAR T1	18112815
324640	462472	2.808682	0.000141	0	0	0	1-HR	ALL	1ST	UCAR T1	18112815
324740	462472	2.844216	0.000148	0	0	0	1-HR	ALL	1ST	UCAR T1	18112815
324840	462472	2.867735	0.000156	0	0	0	1-HR	ALL	1ST	UCAR T1	18112815



AERMOD DISPERSION MODEL VALIDATION STUDY SEPTEMBER 2019  
 Greater Male' Waste to Energy Project  
 Environmental Impact Assessment (EIA) for the Waste to Energy Facility in Thilafushi Island, Maldives

324940	462472	2.875446	0.000165	0	0	0	1-HR	ALL	1ST	UCAR T1	18112815
325040	462472	2.862684	0.000174	0	0	0	1-HR	ALL	1ST	UCAR T1	18112815
325140	462472	2.823828	0.000185	0	0	0	1-HR	ALL	1ST	UCAR T1	18112815
325240	462472	2.752191	0.000198	0	0	0	1-HR	ALL	1ST	UCAR T1	18112815
325340	462472	2.640128	0.000212	0	0	0	1-HR	ALL	1ST	UCAR T1	18112815
325440	462472	2.449177	0.000229	0	0	0	1-HR	ALL	1ST	UCAR T1	18112815
325540	462472	2.169639	0.000248	0	0	0	1-HR	ALL	1ST	UCAR T1	18112815
325640	462472	2.406482	0.000271	0	0	0	1-HR	ALL	1ST	UCAR T1	18112815
325740	462472	2.676701	0.000298	0	0	0	1-HR	ALL	1ST	UCAR T1	18112815
325840	462472	2.977405	0.00034	0	0	0	1-HR	ALL	1ST	UCAR T1	18122415
325940	462472	3.264995	0.000408	0	0	0	1-HR	ALL	1ST	UCAR T1	18122415
326040	462472	3.723298	0.0005	0	0	0	1-HR	ALL	1ST	UCAR T1	18122415
326140	462472	4.100132	0.000631	0	0	0	1-HR	ALL	1ST	UCAR T1	18122415
326240	462472	3.946906	0.000829	0	0	0	1-HR	ALL	1ST	UCAR T1	18122415
326340	462472	4.559498	0.001161	0	0	0	1-HR	ALL	1ST	UCAR T1	18122415
326440	462472	3.921722	0.001818	0	0	0	1-HR	ALL	1ST	UCAR T1	18122415
326540	462472	3.732847	0.007539	0	0	0	1-HR	ALL	1ST	UCAR T1	18110713

AERMOD DISPERSION MODEL VALIDATION STUDY SEPTEMBER 2019  
 Greater Male' Waste to Energy Project  
 Environmental Impact Assessment (EIA) for the Waste to Energy Facility in Thilafushi Island, Maldives

326640	462472	5.528082	0.001625	0	0	0	1-HR	ALL	1ST	UCAR T1	18091617
326740	462472	5.000104	0.001283	0	0	0	1-HR	ALL	1ST	UCAR T1	18091617
326840	462472	4.444643	0.000983	0	0	0	1-HR	ALL	1ST	UCAR T1	18091617
326940	462472	4.939846	0.000785	0	0	0	1-HR	ALL	1ST	UCAR T1	18091617
327040	462472	4.814872	0.000651	0	0	0	1-HR	ALL	1ST	UCAR T1	18091617
327140	462472	5.130539	0.000556	0	0	0	1-HR	ALL	1ST	UCAR T1	18091617
327240	462472	5.755276	0.000484	0	0	0	1-HR	ALL	1ST	UCAR T1	18091617
327340	462472	5.962652	0.000428	0	0	0	1-HR	ALL	1ST	UCAR T1	18091617
327440	462472	5.909024	0.000383	0	0	0	1-HR	ALL	1ST	UCAR T1	18091617
327540	462472	5.708774	0.000346	0	0	0	1-HR	ALL	1ST	UCAR T1	18091617
327640	462472	5.435294	0.000315	0	0	0	1-HR	ALL	1ST	UCAR T1	18091617
327740	462472	5.122469	0.000289	1.3	1.3	0	1-HR	ALL	1ST	UCAR T1	18091617
327840	462472	4.808324	0.000267	4.1	4.1	0	1-HR	ALL	1ST	UCAR T1	18091617
327940	462472	4.520398	0.000247	4.2	4.2	0	1-HR	ALL	1ST	UCAR T1	18091617
328040	462472	4.251132	0.00023	2.2	2.2	0	1-HR	ALL	1ST	UCAR T1	18091617
328140	462472	3.995771	0.000215	1	1	0	1-HR	ALL	1ST	UCAR T1	18091617
328240	462472	3.758198	0.000201	0	0	0	1-HR	ALL	1ST	UCAR T1	18091617

AERMOD DISPERSION MODEL VALIDATION STUDY SEPTEMBER 2019  
 Greater Male' Waste to Energy Project  
 Environmental Impact Assessment (EIA) for the Waste to Energy Facility in Thilafushi Island, Maldives

328340	462472	3.541955	0.000189	0	0	0	1-HR	ALL	1ST	UCAR T1	18091617
328440	462472	3.377733	0.000178	0	0	0	1-HR	ALL	1ST	UCAR T1	18091617
328540	462472	3.270391	0.000168	0	0	0	1-HR	ALL	1ST	UCAR T1	18091617
324540	462572	2.705104	0.000131	0	0	0	1-HR	ALL	1ST	UCAR T1	18021216
324640	462572	2.693824	0.000143	0	0	0	1-HR	ALL	1ST	UCAR T1	18021614
324740	462572	2.658228	0.000157	0	0	0	1-HR	ALL	1ST	UCAR T1	18021614
324840	462572	2.656276	0.000172	0	0	0	1-HR	ALL	1ST	UCAR T1	18021614
324940	462572	2.622587	0.000188	0	0	0	1-HR	ALL	1ST	UCAR T1	18021614
325040	462572	2.547635	0.000207	0	0	0	1-HR	ALL	1ST	UCAR T1	18021614
325140	462572	2.42244	0.000226	0	0	0	1-HR	ALL	1ST	UCAR T1	18021614
325240	462572	2.204273	0.000246	0	0	0	1-HR	ALL	1ST	UCAR T1	18021614
325340	462572	1.895047	0.000266	0	0	0	1-HR	ALL	1ST	UCAR T1	18021614
325440	462572	1.867771	0.000286	0	0	0	1-HR	ALL	1ST	UCAR T1	18021614
325540	462572	1.983431	0.000328	0	0	0	1-HR	ALL	1ST	UCAR T1	18112814
325640	462572	2.088949	0.000372	0	0	0	1-HR	ALL	1ST	UCAR T1	18112814
325740	462572	2.258765	0.000421	0	0	0	1-HR	ALL	1ST	UCAR T1	18032017
325840	462572	2.686205	0.000472	0	0	0	1-HR	ALL	1ST	UCAR T1	18032017

AERMOD DISPERSION MODEL VALIDATION STUDY SEPTEMBER 2019  
 Greater Male' Waste to Energy Project  
 Environmental Impact Assessment (EIA) for the Waste to Energy Facility in Thilafushi Island, Maldives

325940	462572	3.090029	0.000437	0	0	0	1-HR	ALL	1ST	UCAR T1	18032017
326040	462572	3.295234	0.000469	0	0	0	1-HR	ALL	1ST	UCAR T1	18021214
326140	462572	4.263426	0.000639	0	0	0	1-HR	ALL	1ST	UCAR T1	18021615
326240	462572	4.649659	0.001356	0	0	0	1-HR	ALL	1ST	UCAR T1	18030516
326340	462572	4.516643	0.001195	0	0	0	1-HR	ALL	1ST	UCAR T1	18110713
326440	462572	5.24172	0.001484	0	0	0	1-HR	ALL	1ST	UCAR T1	18032618
326540	462572	4.070873	0.0015	0	0	0	1-HR	ALL	1ST	UCAR T1	18041701
326640	462572	4.469814	0.001948	0	0	0	1-HR	ALL	1ST	UCAR T1	18030518
326740	462572	4.892218	0.001869	0	0	0	1-HR	ALL	1ST	UCAR T1	18120317
326840	462572	6.697343	0.000908	0.2	0.2	0	1-HR	ALL	1ST	UCAR T1	18072321
326940	462572	6.780694	0.000593	0.1	0.1	0	1-HR	ALL	1ST	UCAR T1	18101322
327040	462572	6.768516	0.000413	0	0	0	1-HR	ALL	1ST	UCAR T1	18043016
327140	462572	6.966066	0.000368	0	0	0	1-HR	ALL	1ST	UCAR T1	18091616
327240	462572	6.595	0.000425	0	0	0	1-HR	ALL	1ST	UCAR T1	18091616
327340	462572	6.992382	0.000395	0	0	0	1-HR	ALL	1ST	UCAR T1	18091616
327440	462572	7.130035	0.000326	0	0	0	1-HR	ALL	1ST	UCAR T1	18091616
327540	462572	6.671031	0.000251	0.1	0.1	0	1-HR	ALL	1ST	UCAR T1	18091616

327640	462572	5.949005	0.00021	0.4	0.4	0	1-HR	ALL	1ST	UCAR T1	18092801
327740	462572	5.143089	0.000185	2.9	2.9	0	1-HR	ALL	1ST	UCAR T1	18092801
327840	462572	4.393305	0.000163	4.2	4.2	0	1-HR	ALL	1ST	UCAR T1	18092801
327940	462572	3.768736	0.000142	3.9	3.9	0	1-HR	ALL	1ST	UCAR T1	18092801
328040	462572	3.580367	0.000129	0.7	0.7	0	1-HR	ALL	1ST	UCAR T1	18090315
328140	462572	3.379588	0.000124	0	0	0	1-HR	ALL	1ST	UCAR T1	18091617
328240	462572	3.430662	0.000125	0	0	0	1-HR	ALL	1ST	UCAR T1	18091617
328340	462572	3.442945	0.000125	0	0	0	1-HR	ALL	1ST	UCAR T1	18091617
328440	462572	3.425516	0.000125	0	0	0	1-HR	ALL	1ST	UCAR T1	18091617
328540	462572	3.385836	0.000124	0	0	0	1-HR	ALL	1ST	UCAR T1	18091617
324540	462672	2.620288	0.000157	0	0	0	1-HR	ALL	1ST	UCAR T1	18112814
324640	462672	2.662515	0.000172	0	0	0	1-HR	ALL	1ST	UCAR T1	18112814
324740	462672	2.719931	0.000187	0	0	0	1-HR	ALL	1ST	UCAR T1	18112814
324840	462672	2.767451	0.0002	0	0	0	1-HR	ALL	1ST	UCAR T1	18112814
324940	462672	2.878866	0.000213	0	0	0	1-HR	ALL	1ST	UCAR T1	18032017
325040	462672	2.980989	0.000237	0	0	0	1-HR	ALL	1ST	UCAR T1	18032017
325140	462672	3.142298	0.000251	0	0	0	1-HR	ALL	1ST	UCAR T1	18032017

AERMOD DISPERSION MODEL VALIDATION STUDY SEPTEMBER 2019  
 Greater Male' Waste to Energy Project  
 Environmental Impact Assessment (EIA) for the Waste to Energy Facility in Thilafushi Island, Maldives

325240	462672	3.179576	0.000251	0	0	0	1-HR	ALL	1ST	UCAR T1	18032017
325340	462672	3.200913	0.000229	0	0	0	1-HR	ALL	1ST	UCAR T1	18032017
325440	462672	3.671011	0.000243	0	0	0	1-HR	ALL	1ST	UCAR T1	18021214
325540	462672	3.934884	0.000263	0	0	0	1-HR	ALL	1ST	UCAR T1	18021214
325640	462672	4.26626	0.000261	0	0	0	1-HR	ALL	1ST	UCAR T1	18021214
325740	462672	3.834303	0.000344	0	0	0	1-HR	ALL	1ST	UCAR T1	18021615
325840	462672	2.569514	0.00042	0	0	0	1-HR	ALL	1ST	UCAR T1	18021615
325940	462672	2.968015	0.000658	0	0	0	1-HR	ALL	1ST	UCAR T1	18030516
326040	462672	3.235082	0.000942	0	0	0	1-HR	ALL	1ST	UCAR T1	18030516
326140	462672	3.422061	0.000575	0	0	0	1-HR	ALL	1ST	UCAR T1	18110713
326240	462672	4.377388	0.000792	0	0	0	1-HR	ALL	1ST	UCAR T1	18032617
326340	462672	4.794134	0.000834	0	0	0	1-HR	ALL	1ST	UCAR T1	18032618
326440	462672	4.608256	0.001893	0	0	0	1-HR	ALL	1ST	UCAR T1	18030517
326540	462672	4.734972	0.000572	0	0	0	1-HR	ALL	1ST	UCAR T1	18021717
326640	462672	4.768121	0.001598	0	0	0	1-HR	ALL	1ST	UCAR T1	18120318
326740	462672	4.566768	0.001467	0	0	0	1-HR	ALL	1ST	UCAR T1	18030518
326840	462672	5.328331	0.001034	1.6	1.6	0	1-HR	ALL	1ST	UCAR T1	18120317

AERMOD DISPERSION MODEL VALIDATION STUDY SEPTEMBER 2019  
 Greater Male' Waste to Energy Project  
 Environmental Impact Assessment (EIA) for the Waste to Energy Facility in Thilafushi Island, Maldives

326940	462672	5.051786	0.000918	1	1	0	1-HR	ALL	1ST	UCAR T1	18120317
327040	462672	7.606278	0.000534	0	0	0	1-HR	ALL	1ST	UCAR T1	18072321
327140	462672	6.329495	0.000487	0	0	0	1-HR	ALL	1ST	UCAR T1	18072321
327240	462672	6.314084	0.000364	0.2	0.2	0	1-HR	ALL	1ST	UCAR T1	18101322
327340	462672	6.151892	0.000299	0.3	0.3	0	1-HR	ALL	1ST	UCAR T1	18051422
327440	462672	6.273721	0.000219	0.8	0.8	0	1-HR	ALL	1ST	UCAR T1	18043016
327540	462672	5.533336	0.000214	1.5	1.5	0	1-HR	ALL	1ST	UCAR T1	18043016
327640	462672	5.37529	0.000178	3.2	3.2	0	1-HR	ALL	1ST	UCAR T1	18072221
327740	462672	4.770198	0.000202	5.9	5.9	0	1-HR	ALL	1ST	UCAR T1	18091616
327840	462672	4.108427	0.000226	5.8	5.8	0	1-HR	ALL	1ST	UCAR T1	18091616
327940	462672	4.324084	0.000232	3.7	3.7	0	1-HR	ALL	1ST	UCAR T1	18091616
328040	462672	4.344884	0.000222	1.8	1.8	0	1-HR	ALL	1ST	UCAR T1	18091616
328140	462672	4.203992	0.000202	0.1	0.1	0	1-HR	ALL	1ST	UCAR T1	18091616
328240	462672	3.9879	0.000178	0	0	0	1-HR	ALL	1ST	UCAR T1	18091616
328340	462672	3.863561	0.000152	0	0	0	1-HR	ALL	1ST	UCAR T1	18091616
328440	462672	3.680959	0.000134	0	0	0	1-HR	ALL	1ST	UCAR T1	18051423
328540	462672	3.463791	0.00012	0	0	0	1-HR	ALL	1ST	UCAR T1	18051423

AERMOD DISPERSION MODEL VALIDATION STUDY SEPTEMBER 2019  
 Greater Male' Waste to Energy Project  
 Environmental Impact Assessment (EIA) for the Waste to Energy Facility in Thilafushi Island, Maldives

324540	462772	2.83874	0.000168	0	0	0	1-HR	ALL	1ST	UCAR T1	18032017
324640	462772	2.915943	0.000163	0	0	0	1-HR	ALL	1ST	UCAR T1	18032017
324740	462772	2.914341	0.00015	0	0	0	1-HR	ALL	1ST	UCAR T1	18032017
324840	462772	3.251727	0.000157	0	0	0	1-HR	ALL	1ST	UCAR T1	18021214
324940	462772	3.674378	0.000172	0	0	0	1-HR	ALL	1ST	UCAR T1	18021214
325040	462772	3.969907	0.000181	0	0	0	1-HR	ALL	1ST	UCAR T1	18021214
325140	462772	4.029493	0.000182	0	0	0	1-HR	ALL	1ST	UCAR T1	18021214
325240	462772	3.780485	0.000172	0	0	0	1-HR	ALL	1ST	UCAR T1	18021214
325340	462772	3.646984	0.000229	0	0	0	1-HR	ALL	1ST	UCAR T1	18021615
325440	462772	3.434293	0.000279	0	0	0	1-HR	ALL	1ST	UCAR T1	18021615
325540	462772	3.258582	0.000297	0	0	0	1-HR	ALL	1ST	UCAR T1	18021615
325640	462772	3.065706	0.000406	0	0	0	1-HR	ALL	1ST	UCAR T1	18030516
325740	462772	2.998624	0.00062	0	0	0	1-HR	ALL	1ST	UCAR T1	18030516
325840	462772	2.647702	0.000537	0	0	0	1-HR	ALL	1ST	UCAR T1	18030516
325940	462772	2.668368	0.000406	0	0	0	1-HR	ALL	1ST	UCAR T1	18112613
326040	462772	3.341947	0.000752	0	0	0	1-HR	ALL	1ST	UCAR T1	18110713
326140	462772	3.401801	0.000584	0	0	0	1-HR	ALL	1ST	UCAR T1	18032619



326240	462772	3.844637	0.000561	0	0	0	1-HR	ALL	1ST	UCAR T1	18032618
326340	462772	4.321843	0.001387	0	0	0	1-HR	ALL	1ST	UCAR T1	18041624
326440	462772	4.129967	0.000475	0	0	0	1-HR	ALL	1ST	UCAR T1	18110520
326540	462772	4.363102	0.000492	0	0	0	1-HR	ALL	1ST	UCAR T1	18021717
326640	462772	4.304239	0.000632	0	0	0	1-HR	ALL	1ST	UCAR T1	18032817
326740	462772	4.910583	0.001089	0	0	0	1-HR	ALL	1ST	UCAR T1	18032814
326840	462772	4.457739	0.001029	0.7	0.7	0	1-HR	ALL	1ST	UCAR T1	18030518
326940	462772	4.731296	0.000534	1	1	0	1-HR	ALL	1ST	UCAR T1	18120317
327040	462772	7.348092	0.000715	0.5	0.5	0	1-HR	ALL	1ST	UCAR T1	18120317
327140	462772	7.037253	0.000542	0.6	0.6	0	1-HR	ALL	1ST	UCAR T1	18120317
327240	462772	6.180103	0.000329	1.3	1.3	0	1-HR	ALL	1ST	UCAR T1	18072321
327340	462772	5.658435	0.000397	1.8	1.8	0	1-HR	ALL	1ST	UCAR T1	18072321
327440	462772	4.930556	0.00032	2.5	2.5	0	1-HR	ALL	1ST	UCAR T1	18072321
327540	462772	4.841935	0.000237	1.3	1.3	0	1-HR	ALL	1ST	UCAR T1	18101322
327640	462772	4.752861	0.000255	1.1	1.1	0	1-HR	ALL	1ST	UCAR T1	18101322
327740	462772	5.286693	0.000207	3.3	3.3	0	1-HR	ALL	1ST	UCAR T1	18051422
327840	462772	5.074227	0.000158	5.2	5.2	0	1-HR	ALL	1ST	UCAR T1	18051422

AERMOD DISPERSION MODEL VALIDATION STUDY SEPTEMBER 2019  
 Greater Male' Waste to Energy Project  
 Environmental Impact Assessment (EIA) for the Waste to Energy Facility in Thilafushi Island, Maldives

327940	462772	4.398714	0.000153	4.1	4.1	0	1-HR	ALL	1ST	UCAR T1	18043016
328040	462772	3.718727	0.000144	0.5	0.5	0	1-HR	ALL	1ST	UCAR T1	18043016
328140	462772	3.573819	0.000128	0	0	0	1-HR	ALL	1ST	UCAR T1	18072221
328240	462772	3.293692	0.000115	0	0	0	1-HR	ALL	1ST	UCAR T1	18072221
328340	462772	3.160141	0.000134	0	0	0	1-HR	ALL	1ST	UCAR T1	18091616
328440	462772	3.062901	0.000148	0	0	0	1-HR	ALL	1ST	UCAR T1	18091616
328540	462772	3.179717	0.000155	0	0	0	1-HR	ALL	1ST	UCAR T1	18091616
324540	462872	3.484017	0.000135	0	0	0	1-HR	ALL	1ST	UCAR T1	18021214
324640	462872	3.631587	0.000137	0	0	0	1-HR	ALL	1ST	UCAR T1	18021214
324740	462872	3.616401	0.000134	0	0	0	1-HR	ALL	1ST	UCAR T1	18112913
324840	462872	3.394235	0.000131	0	0	0	1-HR	ALL	1ST	UCAR T1	18021615
324940	462872	3.028842	0.000167	0	0	0	1-HR	ALL	1ST	UCAR T1	18021615
325040	462872	3.153281	0.000201	0	0	0	1-HR	ALL	1ST	UCAR T1	18021615
325140	462872	3.342402	0.000223	0	0	0	1-HR	ALL	1ST	UCAR T1	18021615
325240	462872	3.131801	0.000223	0	0	0	1-HR	ALL	1ST	UCAR T1	18021615
325340	462872	3.173938	0.000277	0	0	0	1-HR	ALL	1ST	UCAR T1	18030516
325440	462872	3.463619	0.000421	0	0	0	1-HR	ALL	1ST	UCAR T1	18030516

AERMOD DISPERSION MODEL VALIDATION STUDY SEPTEMBER 2019  
 Greater Male' Waste to Energy Project  
 Environmental Impact Assessment (EIA) for the Waste to Energy Facility in Thilafushi Island, Maldives

325540	462872	3.112601	0.000463	0	0	0	1-HR	ALL	1ST	UCAR T1	18030516
325640	462872	3.163269	0.00032	0	0	0	1-HR	ALL	1ST	UCAR T1	18030516
325740	462872	2.718532	0.000313	0	0	0	1-HR	ALL	1ST	UCAR T1	18112613
325840	462872	3.675658	0.000551	0	0	0	1-HR	ALL	1ST	UCAR T1	18110713
325940	462872	2.668498	0.000434	0	0	0	1-HR	ALL	1ST	UCAR T1	18021619
326040	462872	2.624941	0.000503	0	0	0	1-HR	ALL	1ST	UCAR T1	18032619
326140	462872	3.241848	0.000416	0	0	0	1-HR	ALL	1ST	UCAR T1	18032618
326240	462872	3.200604	0.000635	0	0	0	1-HR	ALL	1ST	UCAR T1	18110712
326340	462872	3.587123	0.000662	0	0	0	1-HR	ALL	1ST	UCAR T1	18030517
326440	462872	5.285625	0.001295	0	0	0	1-HR	ALL	1ST	UCAR T1	18031521
326540	462872	3.879393	0.00043	0	0	0	1-HR	ALL	1ST	UCAR T1	18110715
326640	462872	3.989401	0.000596	0	0	0	1-HR	ALL	1ST	UCAR T1	18032821
326740	462872	3.8848	0.000886	0	0	0	1-HR	ALL	1ST	UCAR T1	18120318
326840	462872	3.90233	0.000557	0	0	0	1-HR	ALL	1ST	UCAR T1	18032814
326940	462872	4.609087	0.000759	0.6	0.6	0	1-HR	ALL	1ST	UCAR T1	18030518
327040	462872	6.039223	0.000333	1.4	1.4	0	1-HR	ALL	1ST	UCAR T1	18102414
327140	462872	5.76784	0.000475	2	2	0	1-HR	ALL	1ST	UCAR T1	18120317

AERMOD DISPERSION MODEL VALIDATION STUDY SEPTEMBER 2019  
 Greater Male' Waste to Energy Project  
 Environmental Impact Assessment (EIA) for the Waste to Energy Facility in Thilafushi Island, Maldives

327240	462872	6.653485	0.000482	1.9	1.9	0	1-HR	ALL	1ST	UCAR T1	18120317
327340	462872	6.20069	0.000352	1.8	1.8	0	1-HR	ALL	1ST	UCAR T1	18120317
327440	462872	4.465077	0.000268	1.7	1.7	0	1-HR	ALL	1ST	UCAR T1	18050523
327540	462872	4.66869	0.000298	0.3	0.3	0	1-HR	ALL	1ST	UCAR T1	18072321
327640	462872	4.300627	0.000295	0	0	0	1-HR	ALL	1ST	UCAR T1	18072321
327740	462872	4.028771	0.000232	0	0	0	1-HR	ALL	1ST	UCAR T1	18072321
327840	462872	3.639904	0.000168	0.9	0.9	0	1-HR	ALL	1ST	UCAR T1	18101322
327940	462872	3.853117	0.000202	1.8	1.8	0	1-HR	ALL	1ST	UCAR T1	18101322
328040	462872	3.995473	0.000182	0.3	0.3	0	1-HR	ALL	1ST	UCAR T1	18101322
328140	462872	4.139007	0.000157	0	0	0	1-HR	ALL	1ST	UCAR T1	18051422
328240	462872	3.947754	0.000125	0	0	0	1-HR	ALL	1ST	UCAR T1	18051422
328340	462872	3.543496	0.000115	0	0	0	1-HR	ALL	1ST	UCAR T1	18043016
328440	462872	3.041234	0.000114	0	0	0	1-HR	ALL	1ST	UCAR T1	18043016
328540	462872	2.850847	0.000107	0	0	0	1-HR	ALL	1ST	UCAR T1	18043016
324540	462972	2.800273	0.000129	0	0	0	1-HR	ALL	1ST	UCAR T1	18021615
324640	462972	2.85087	0.000153	0	0	0	1-HR	ALL	1ST	UCAR T1	18021615
324740	462972	2.9381	0.000172	0	0	0	1-HR	ALL	1ST	UCAR T1	18021615

AERMOD DISPERSION MODEL VALIDATION STUDY SEPTEMBER 2019  
 Greater Male' Waste to Energy Project  
 Environmental Impact Assessment (EIA) for the Waste to Energy Facility in Thilafushi Island, Maldives

324840	462972	2.999025	0.000181	0	0	0	1-HR	ALL	1ST	UCAR T1	18021615
324940	462972	2.79215	0.000178	0	0	0	1-HR	ALL	1ST	UCAR T1	18111513
325040	462972	3.12734	0.000204	0	0	0	1-HR	ALL	1ST	UCAR T1	18112813
325140	462972	3.317945	0.0003	0	0	0	1-HR	ALL	1ST	UCAR T1	18030516
325240	462972	3.160193	0.000361	0	0	0	1-HR	ALL	1ST	UCAR T1	18030516
325340	462972	3.163609	0.000326	0	0	0	1-HR	ALL	1ST	UCAR T1	18030516
325440	462972	3.385327	0.000201	0	0	0	1-HR	ALL	1ST	UCAR T1	18030516
325540	462972	2.971607	0.000254	0	0	0	1-HR	ALL	1ST	UCAR T1	18112613
325640	462972	3.845212	0.000399	0	0	0	1-HR	ALL	1ST	UCAR T1	18110713
325740	462972	3.261572	0.000378	0	0	0	1-HR	ALL	1ST	UCAR T1	18110713
325840	462972	2.259384	0.000287	0	0	0	1-HR	ALL	1ST	UCAR T1	18021619
325940	462972	2.002552	0.000391	0	0	0	1-HR	ALL	1ST	UCAR T1	18021618
326040	462972	2.769148	0.000326	0	0	0	1-HR	ALL	1ST	UCAR T1	18032618
326140	462972	3.060572	0.000466	0	0	0	1-HR	ALL	1ST	UCAR T1	18110714
326240	462972	3.283	0.00103	0	0	0	1-HR	ALL	1ST	UCAR T1	18030517
326340	462972	3.228098	0.000281	0	0	0	1-HR	ALL	1ST	UCAR T1	18110520
326440	462972	4.662418	0.000996	0	0	0	1-HR	ALL	1ST	UCAR T1	18031521

326540	462972	3.521352	0.000376	0	0	0	1-HR	ALL	1ST	UCAR T1	18110715
326640	462972	3.380281	0.000433	0	0	0	1-HR	ALL	1ST	UCAR T1	18041702
326740	462972	6.340668	0.000682	0	0	0	1-HR	ALL	1ST	UCAR T1	18120319
326840	462972	6.514128	0.000585	0	0	0	1-HR	ALL	1ST	UCAR T1	18032814
326940	462972	4.519163	0.000357	0	0	0	1-HR	ALL	1ST	UCAR T1	18041719
327040	462972	4.874419	0.000587	0.1	0.1	0	1-HR	ALL	1ST	UCAR T1	18030518
327140	462972	6.263561	0.000306	1.1	1.1	0	1-HR	ALL	1ST	UCAR T1	18111013
327240	462972	4.581934	0.000303	1	1	0	1-HR	ALL	1ST	UCAR T1	18120317
327340	462972	5.721847	0.000385	0.6	0.6	0	1-HR	ALL	1ST	UCAR T1	18032919
327440	462972	5.742213	0.000335	0.3	0.3	0	1-HR	ALL	1ST	UCAR T1	18120317
327540	462972	5.043265	0.000284	0	0	0	1-HR	ALL	1ST	UCAR T1	18111014
327640	462972	3.975188	0.000231	0	0	0	1-HR	ALL	1ST	UCAR T1	18050523
327740	462972	4.013742	0.000227	0	0	0	1-HR	ALL	1ST	UCAR T1	18102413
327840	462972	4.183594	0.000248	0	0	0	1-HR	ALL	1ST	UCAR T1	18072321
327940	462972	3.489359	0.000226	0	0	0	1-HR	ALL	1ST	UCAR T1	18072321
328040	462972	3.430425	0.000177	0	0	0	1-HR	ALL	1ST	UCAR T1	18072321
328140	462972	3.245382	0.00013	0	0	0	1-HR	ALL	1ST	UCAR T1	18091615

328240	462972	3.120135	0.000159	0	0	0	1-HR	ALL	1ST	UCAR T1	18101322
328340	462972	3.441542	0.000161	0	0	0	1-HR	ALL	1ST	UCAR T1	18101322
328440	462972	3.505242	0.000138	0	0	0	1-HR	ALL	1ST	UCAR T1	18051422
328540	462972	3.335783	0.000125	0	0	0	1-HR	ALL	1ST	UCAR T1	18051422
324540	463072	2.622995	0.000148	0	0	0	1-HR	ALL	1ST	UCAR T1	18021615
324640	463072	2.613109	0.000146	0	0	0	1-HR	ALL	1ST	UCAR T1	18111513
324740	463072	2.922508	0.000167	0	0	0	1-HR	ALL	1ST	UCAR T1	18112813
324840	463072	2.992191	0.000222	0	0	0	1-HR	ALL	1ST	UCAR T1	18030516
324940	463072	3.037474	0.000278	0	0	0	1-HR	ALL	1ST	UCAR T1	18030516
325040	463072	3.168619	0.000285	0	0	0	1-HR	ALL	1ST	UCAR T1	18030516
325140	463072	2.939618	0.000228	0	0	0	1-HR	ALL	1ST	UCAR T1	18030516
325240	463072	3.326894	0.000164	0	0	0	1-HR	ALL	1ST	UCAR T1	18111514
325340	463072	2.957077	0.000212	0	0	0	1-HR	ALL	1ST	UCAR T1	18112613
325440	463072	3.570324	0.000298	0	0	0	1-HR	ALL	1ST	UCAR T1	18110713
325540	463072	3.766563	0.000346	0	0	0	1-HR	ALL	1ST	UCAR T1	18110713
325640	463072	2.119431	0.000293	0	0	0	1-HR	ALL	1ST	UCAR T1	18021619
325740	463072	1.804758	0.000314	0	0	0	1-HR	ALL	1ST	UCAR T1	18032619

AERMOD DISPERSION MODEL VALIDATION STUDY SEPTEMBER 2019  
 Greater Male' Waste to Energy Project  
 Environmental Impact Assessment (EIA) for the Waste to Energy Facility in Thilafushi Island, Maldives

325840	463072	1.804363	0.000322	0	0	0	1-HR	ALL	1ST	UCAR T1	18032620
325940	463072	2.319717	0.000265	0	0	0	1-HR	ALL	1ST	UCAR T1	18032618
326040	463072	2.644109	0.000463	0	0	0	1-HR	ALL	1ST	UCAR T1	18110714
326140	463072	2.99647	0.000743	0	0	0	1-HR	ALL	1ST	UCAR T1	18041624
326240	463072	2.826538	0.000367	0	0	0	1-HR	ALL	1ST	UCAR T1	18041623
326340	463072	4.432144	0.000238	0	0	0	1-HR	ALL	1ST	UCAR T1	18110520
326440	463072	2.833606	0.000664	0	0	0	1-HR	ALL	1ST	UCAR T1	18041701
326540	463072	3.177652	0.000331	0	0	0	1-HR	ALL	1ST	UCAR T1	18110715
326640	463072	3.111261	0.000427	0	0	0	1-HR	ALL	1ST	UCAR T1	18032820
326740	463072	5.597975	0.000425	0	0	0	1-HR	ALL	1ST	UCAR T1	18032817
326840	463072	3.370147	0.000569	0	0	0	1-HR	ALL	1ST	UCAR T1	18120318
326940	463072	4.541458	0.000605	0	0	0	1-HR	ALL	1ST	UCAR T1	18032814
327040	463072	6.250316	0.000267	0	0	0	1-HR	ALL	1ST	UCAR T1	18030518
327140	463072	4.920527	0.000471	0	0	0	1-HR	ALL	1ST	UCAR T1	18030518
327240	463072	5.801478	0.000284	0	0	0	1-HR	ALL	1ST	UCAR T1	18111013
327340	463072	4.693434	0.000222	0	0	0	1-HR	ALL	1ST	UCAR T1	18102414
327440	463072	4.421281	0.000304	0	0	0	1-HR	ALL	1ST	UCAR T1	18032919



AERMOD DISPERSION MODEL VALIDATION STUDY SEPTEMBER 2019  
 Greater Male' Waste to Energy Project  
 Environmental Impact Assessment (EIA) for the Waste to Energy Facility in Thilafushi Island, Maldives

327540	463072	5.009512	0.000281	0	0	0	1-HR	ALL	1ST	UCAR T1	18120317
327640	463072	4.944077	0.000246	0	0	0	1-HR	ALL	1ST	UCAR T1	18111014
327740	463072	4.419031	0.000236	0	0	0	1-HR	ALL	1ST	UCAR T1	18111014
327840	463072	3.680368	0.0002	0	0	0	1-HR	ALL	1ST	UCAR T1	18050523
327940	463072	3.459225	0.000176	0	0	0	1-HR	ALL	1ST	UCAR T1	18102413
328040	463072	3.746309	0.0002	0	0	0	1-HR	ALL	1ST	UCAR T1	18072321
328140	463072	3.465995	0.000203	0	0	0	1-HR	ALL	1ST	UCAR T1	18072321
328240	463072	3.090565	0.000178	0	0	0	1-HR	ALL	1ST	UCAR T1	18072321
328340	463072	3.088404	0.000141	0	0	0	1-HR	ALL	1ST	UCAR T1	18091615
328440	463072	2.912207	0.000113	0	0	0	1-HR	ALL	1ST	UCAR T1	18091615
328540	463072	2.880422	0.000127	0	0	0	1-HR	ALL	1ST	UCAR T1	18101322
324540	463172	2.748526	0.000169	0	0	0	1-HR	ALL	1ST	UCAR T1	18030516
324640	463172	2.771706	0.000216	0	0	0	1-HR	ALL	1ST	UCAR T1	18030516
324740	463172	2.874673	0.000238	0	0	0	1-HR	ALL	1ST	UCAR T1	18030516
324840	463172	2.972185	0.000218	0	0	0	1-HR	ALL	1ST	UCAR T1	18030516
324940	463172	2.819499	0.000161	0	0	0	1-HR	ALL	1ST	UCAR T1	18030516
325040	463172	3.143402	0.000136	0	0	0	1-HR	ALL	1ST	UCAR T1	18111514

325140	463172	2.81753	0.000181	0	0	0	1-HR	ALL	1ST	UCAR T1	18112613
325240	463172	3.170968	0.00023	0	0	0	1-HR	ALL	1ST	UCAR T1	18110713
325340	463172	3.714616	0.000292	0	0	0	1-HR	ALL	1ST	UCAR T1	18110713
325440	463172	2.846632	0.000274	0	0	0	1-HR	ALL	1ST	UCAR T1	18032617
325540	463172	1.589434	0.000213	0	0	0	1-HR	ALL	1ST	UCAR T1	18021619
325640	463172	1.412912	0.000302	0	0	0	1-HR	ALL	1ST	UCAR T1	18032619
325740	463172	1.579487	0.000306	0	0	0	1-HR	ALL	1ST	UCAR T1	18032618
325840	463172	1.934004	0.000221	0	0	0	1-HR	ALL	1ST	UCAR T1	18032618
325940	463172	2.216997	0.00041	0	0	0	1-HR	ALL	1ST	UCAR T1	18110714
326040	463172	2.347696	0.000423	0	0	0	1-HR	ALL	1ST	UCAR T1	18041624
326140	463172	2.486252	0.000699	0	0	0	1-HR	ALL	1ST	UCAR T1	18030517
326240	463172	3.686641	0.000195	0	0	0	1-HR	ALL	1ST	UCAR T1	18110615
326340	463172	6.872467	0.000502	0	0	0	1-HR	ALL	1ST	UCAR T1	18031521
326440	463172	2.587147	0.000436	0	0	0	1-HR	ALL	1ST	UCAR T1	18041701
326540	463172	2.80381	0.000294	0	0	0	1-HR	ALL	1ST	UCAR T1	18110715
326640	463172	2.867415	0.000392	0	0	0	1-HR	ALL	1ST	UCAR T1	18032820
326740	463172	3.717619	0.000369	0	0	0	1-HR	ALL	1ST	UCAR T1	18021714

AERMOD DISPERSION MODEL VALIDATION STUDY SEPTEMBER 2019  
 Greater Male' Waste to Energy Project  
 Environmental Impact Assessment (EIA) for the Waste to Energy Facility in Thilafushi Island, Maldives

326840	463172	5.07278	0.000571	0	0	0	1-HR	ALL	1ST	UCAR T1	18120318
326940	463172	6.309609	0.000332	0	0	0	1-HR	ALL	1ST	UCAR T1	18032814
327040	463172	3.740504	0.000366	0	0	0	1-HR	ALL	1ST	UCAR T1	18032814
327140	463172	6.570182	0.000298	0	0	0	1-HR	ALL	1ST	UCAR T1	18030518
327240	463172	5.095736	0.000388	0	0	0	1-HR	ALL	1ST	UCAR T1	18030518
327340	463172	5.139282	0.000261	0	0	0	1-HR	ALL	1ST	UCAR T1	18111013
327440	463172	4.361402	0.00021	0	0	0	1-HR	ALL	1ST	UCAR T1	18102414
327540	463172	4.081452	0.000222	0	0	0	1-HR	ALL	1ST	UCAR T1	18101324
327640	463172	4.015899	0.000284	0	0	0	1-HR	ALL	1ST	UCAR T1	18032919
327740	463172	4.335238	0.000214	0	0	0	1-HR	ALL	1ST	UCAR T1	18120317
327840	463172	4.208372	0.000216	0	0	0	1-HR	ALL	1ST	UCAR T1	18111014
327940	463172	4.207438	0.000201	0	0	0	1-HR	ALL	1ST	UCAR T1	18111014
328040	463172	3.526779	0.000175	0	0	0	1-HR	ALL	1ST	UCAR T1	18050523
328140	463172	3.371492	0.000137	0	0	0	1-HR	ALL	1ST	UCAR T1	18102413
328240	463172	3.248516	0.000167	0	0	0	1-HR	ALL	1ST	UCAR T1	18102413
328340	463172	3.224178	0.000174	0	0	0	1-HR	ALL	1ST	UCAR T1	18072321
328440	463172	2.851392	0.000167	0	0	0	1-HR	ALL	1ST	UCAR T1	18072320

AERMOD DISPERSION MODEL VALIDATION STUDY SEPTEMBER 2019  
 Greater Male' Waste to Energy Project  
 Environmental Impact Assessment (EIA) for the Waste to Energy Facility in Thilafushi Island, Maldives

328540	463172	2.821646	0.000144	0	0	0	1-HR	ALL	1ST	UCAR T1	18072321
324540	463272	2.748662	0.000194	0	0	0	1-HR	ALL	1ST	UCAR T1	18030516
324640	463272	2.695969	0.000165	0	0	0	1-HR	ALL	1ST	UCAR T1	18030516
324740	463272	2.790213	0.000127	0	0	0	1-HR	ALL	1ST	UCAR T1	18111514
324840	463272	2.915623	0.000115	0	0	0	1-HR	ALL	1ST	UCAR T1	18111514
324940	463272	2.629481	0.000156	0	0	0	1-HR	ALL	1ST	UCAR T1	18112613
325040	463272	2.772722	0.000182	0	0	0	1-HR	ALL	1ST	UCAR T1	18110713
325140	463272	3.42672	0.000241	0	0	0	1-HR	ALL	1ST	UCAR T1	18110713
325240	463272	3.113964	0.000235	0	0	0	1-HR	ALL	1ST	UCAR T1	18032617
325340	463272	2.367011	0.000216	0	0	0	1-HR	ALL	1ST	UCAR T1	18021619
325440	463272	1.296932	0.000194	0	0	0	1-HR	ALL	1ST	UCAR T1	18032619
325540	463272	1.15153	0.000265	0	0	0	1-HR	ALL	1ST	UCAR T1	18032619
325640	463272	1.368743	0.000283	0	0	0	1-HR	ALL	1ST	UCAR T1	18032618
325740	463272	1.616795	0.000188	0	0	0	1-HR	ALL	1ST	UCAR T1	18032618
325840	463272	1.848456	0.000348	0	0	0	1-HR	ALL	1ST	UCAR T1	18110714
325940	463272	1.808622	0.000282	0	0	0	1-HR	ALL	1ST	UCAR T1	18110712
326040	463272	2.191164	0.000587	0	0	0	1-HR	ALL	1ST	UCAR T1	18041624

AERMOD DISPERSION MODEL VALIDATION STUDY SEPTEMBER 2019  
 Greater Male' Waste to Energy Project  
 Environmental Impact Assessment (EIA) for the Waste to Energy Facility in Thilafushi Island, Maldives

326140	463272	2.195239	0.000234	0	0	0	1-HR	ALL	1ST	UCAR T1	18041623
326240	463272	4.370981	0.000228	0	0	0	1-HR	ALL	1ST	UCAR T1	18110520
326340	463272	6.437573	0.000661	0	0	0	1-HR	ALL	1ST	UCAR T1	18031521
326440	463272	2.177906	0.000243	0	0	0	1-HR	ALL	1ST	UCAR T1	18041701
326540	463272	2.451812	0.000264	0	0	0	1-HR	ALL	1ST	UCAR T1	18110715
326640	463272	2.557082	0.000344	0	0	0	1-HR	ALL	1ST	UCAR T1	18032820
326740	463272	3.519031	0.000347	0	0	0	1-HR	ALL	1ST	UCAR T1	18032821
326840	463272	6.508812	0.000457	0	0	0	1-HR	ALL	1ST	UCAR T1	18120319
326940	463272	3.42066	0.0004	0	0	0	1-HR	ALL	1ST	UCAR T1	18120318
327040	463272	5.151383	0.000457	0	0	0	1-HR	ALL	1ST	UCAR T1	18032814
327140	463272	3.808623	0.000231	0	0	0	1-HR	ALL	1ST	UCAR T1	18041719
327240	463272	6.127557	0.000298	0	0	0	1-HR	ALL	1ST	UCAR T1	18030518
327340	463272	5.026819	0.000326	0	0	0	1-HR	ALL	1ST	UCAR T1	18030518
327440	463272	4.496284	0.000239	0	0	0	1-HR	ALL	1ST	UCAR T1	18111013
327540	463272	3.992538	0.00019	0	0	0	1-HR	ALL	1ST	UCAR T1	18102414
327640	463272	3.761142	0.000197	0	0	0	1-HR	ALL	1ST	UCAR T1	18101324
327740	463272	3.905352	0.000232	0	0	0	1-HR	ALL	1ST	UCAR T1	18032919

AERMOD DISPERSION MODEL VALIDATION STUDY SEPTEMBER 2019  
 Greater Male' Waste to Energy Project  
 Environmental Impact Assessment (EIA) for the Waste to Energy Facility in Thilafushi Island, Maldives

327840	463272	3.835587	0.000229	0	0	0	1-HR	ALL	1ST	UCAR T1	18032919
327940	463272	3.659571	0.000175	0	0	0	1-HR	ALL	1ST	UCAR T1	18101323
328040	463272	4.098421	0.00019	0	0	0	1-HR	ALL	1ST	UCAR T1	18111014
328140	463272	3.922772	0.000173	0	0	0	1-HR	ALL	1ST	UCAR T1	18111014
328240	463272	3.314957	0.000154	0	0	0	1-HR	ALL	1ST	UCAR T1	18050523
328340	463272	3.190192	0.000121	0	0	0	1-HR	ALL	1ST	UCAR T1	18051420
328440	463272	3.070742	0.000139	0	0	0	1-HR	ALL	1ST	UCAR T1	18102413
328540	463272	2.906966	0.000148	0	0	0	1-HR	ALL	1ST	UCAR T1	18102413
324540	463372	2.716166	0.000113	0	0	0	1-HR	ALL	1ST	UCAR T1	18111514
324640	463372	2.728413	0.000102	0	0	0	1-HR	ALL	1ST	UCAR T1	18112613
324740	463372	2.430573	0.000137	0	0	0	1-HR	ALL	1ST	UCAR T1	18112613
324840	463372	2.416681	0.000158	0	0	0	1-HR	ALL	1ST	UCAR T1	18112613
324940	463372	3.07132	0.000199	0	0	0	1-HR	ALL	1ST	UCAR T1	18110713
325040	463372	3.087878	0.000207	0	0	0	1-HR	ALL	1ST	UCAR T1	18110713
325140	463372	2.716777	0.000209	0	0	0	1-HR	ALL	1ST	UCAR T1	18032617
325240	463372	2.194169	0.000165	0	0	0	1-HR	ALL	1ST	UCAR T1	18021619
325340	463372	1.104496	0.00021	0	0	0	1-HR	ALL	1ST	UCAR T1	18032619

AERMOD DISPERSION MODEL VALIDATION STUDY SEPTEMBER 2019  
 Greater Male' Waste to Energy Project  
 Environmental Impact Assessment (EIA) for the Waste to Energy Facility in Thilafushi Island, Maldives

325440	463372	0.962217	0.000228	0	0	0	1-HR	ALL	1ST	UCAR T1	18021618
325540	463372	1.185492	0.000258	0	0	0	1-HR	ALL	1ST	UCAR T1	18032618
325640	463372	1.859467	0.000162	0	0	0	1-HR	ALL	1ST	UCAR T1	18032618
325740	463372	2.14944	0.000292	0	0	0	1-HR	ALL	1ST	UCAR T1	18110714
325840	463372	1.663027	0.000252	0	0	0	1-HR	ALL	1ST	UCAR T1	18112614
325940	463372	1.95339	0.000484	0	0	0	1-HR	ALL	1ST	UCAR T1	18041624
326040	463372	2.985632	0.000456	0	0	0	1-HR	ALL	1ST	UCAR T1	18030517
326140	463372	3.281823	0.000166	0	0	0	1-HR	ALL	1ST	UCAR T1	18110615
326240	463372	3.951998	0.000152	0	0	0	1-HR	ALL	1ST	UCAR T1	18110520
326340	463372	4.671931	0.000566	0	0	0	1-HR	ALL	1ST	UCAR T1	18031521
326440	463372	1.96151	0.000128	0	0	0	1-HR	ALL	1ST	UCAR T1	18041701
326540	463372	2.138482	0.000239	0	0	0	1-HR	ALL	1ST	UCAR T1	18110715
326640	463372	2.248924	0.000294	0	0	0	1-HR	ALL	1ST	UCAR T1	18032820
326740	463372	3.399348	0.000296	0	0	0	1-HR	ALL	1ST	UCAR T1	18032821
326840	463372	5.362215	0.000309	0	0	0	1-HR	ALL	1ST	UCAR T1	18032817
326940	463372	3.315381	0.000453	0	0	0	1-HR	ALL	1ST	UCAR T1	18120318
327040	463372	5.237955	0.000215	0	0	0	1-HR	ALL	1ST	UCAR T1	18101418

AERMOD DISPERSION MODEL VALIDATION STUDY SEPTEMBER 2019  
 Greater Male' Waste to Energy Project  
 Environmental Impact Assessment (EIA) for the Waste to Energy Facility in Thilafushi Island, Maldives

327140	463372	3.00516	0.000396	0	0	0	1-HR	ALL	1ST	UCAR T1	18032814
327240	463372	4.140754	0.000223	0	0	0	1-HR	ALL	1ST	UCAR T1	18041719
327340	463372	5.416532	0.000283	0	0	0	1-HR	ALL	1ST	UCAR T1	18030518
327440	463372	4.830872	0.000278	0	0	0	1-HR	ALL	1ST	UCAR T1	18030518
327540	463372	3.934637	0.00022	0	0	0	1-HR	ALL	1ST	UCAR T1	18111013
327640	463372	3.535508	0.000168	0	0	0	1-HR	ALL	1ST	UCAR T1	18102414
327740	463372	3.645557	0.000151	0	0	0	1-HR	ALL	1ST	UCAR T1	18101324
327840	463372	3.875309	0.000167	0	0	0	1-HR	ALL	1ST	UCAR T1	18032919
327940	463372	3.412618	0.000222	0	0	0	1-HR	ALL	1ST	UCAR T1	18032919
328040	463372	3.700708	0.000173	0	0	0	1-HR	ALL	1ST	UCAR T1	18032919
328140	463372	3.376016	0.000154	0	0	0	1-HR	ALL	1ST	UCAR T1	18101323
328240	463372	3.886147	0.000169	0	0	0	1-HR	ALL	1ST	UCAR T1	18111014
328340	463372	3.623851	0.000151	0	0	0	1-HR	ALL	1ST	UCAR T1	18111014
328440	463372	3.088747	0.000137	0	0	0	1-HR	ALL	1ST	UCAR T1	18050523
328540	463372	2.972389	0.000111	0	0	0	1-HR	ALL	1ST	UCAR T1	18051420
324540	463472	2.297945	0.000121	0	0	0	1-HR	ALL	1ST	UCAR T1	18112613
324640	463472	2.111389	0.00014	0	0	0	1-HR	ALL	1ST	UCAR T1	18112613



324740	463472	2.721708	0.000166	0	0	0	1-HR	ALL	1ST	UCAR T1	18110713
324840	463472	2.914498	0.000183	0	0	0	1-HR	ALL	1ST	UCAR T1	18110713
324940	463472	2.716284	0.000191	0	0	0	1-HR	ALL	1ST	UCAR T1	18032617
325040	463472	2.759609	0.000167	0	0	0	1-HR	ALL	1ST	UCAR T1	18021619
325140	463472	1.815683	0.00015	0	0	0	1-HR	ALL	1ST	UCAR T1	18032615
325240	463472	1.01024	0.000209	0	0	0	1-HR	ALL	1ST	UCAR T1	18032619
325340	463472	0.823558	0.000203	0	0	0	1-HR	ALL	1ST	UCAR T1	18021618
325440	463472	1.03056	0.000234	0	0	0	1-HR	ALL	1ST	UCAR T1	18032618
325540	463472	2.045753	0.000145	0	0	0	1-HR	ALL	1ST	UCAR T1	18041101
325640	463472	2.529513	0.000245	0	0	0	1-HR	ALL	1ST	UCAR T1	18110714
325740	463472	1.488257	0.000212	0	0	0	1-HR	ALL	1ST	UCAR T1	18112614
325840	463472	2.177307	0.000324	0	0	0	1-HR	ALL	1ST	UCAR T1	18041624
325940	463472	2.88356	0.000459	0	0	0	1-HR	ALL	1ST	UCAR T1	18030517
326040	463472	2.227718	0.00016	0	0	0	1-HR	ALL	1ST	UCAR T1	18041623
326140	463472	4.223961	0.000165	0	0	0	1-HR	ALL	1ST	UCAR T1	18110520
326240	463472	5.117894	0.000252	0	0	0	1-HR	ALL	1ST	UCAR T1	18031521
326340	463472	2.979505	0.000385	0	0	0	1-HR	ALL	1ST	UCAR T1	18041701

AERMOD DISPERSION MODEL VALIDATION STUDY SEPTEMBER 2019  
 Greater Male' Waste to Energy Project  
 Environmental Impact Assessment (EIA) for the Waste to Energy Facility in Thilafushi Island, Maldives

326440	463472	2.276574	0.000076	0	0	0	1-HR	ALL	1ST	UCAR T1	18032708
326540	463472	1.866492	0.000218	0	0	0	1-HR	ALL	1ST	UCAR T1	18110715
326640	463472	1.968912	0.000249	0	0	0	1-HR	ALL	1ST	UCAR T1	18032820
326740	463472	3.238748	0.00023	0	0	0	1-HR	ALL	1ST	UCAR T1	18032821
326840	463472	4.655139	0.000209	0	0	0	1-HR	ALL	1ST	UCAR T1	18021714
326940	463472	4.820625	0.00036	0	0	0	1-HR	ALL	1ST	UCAR T1	18120318
327040	463472	3.414291	0.000296	0	0	0	1-HR	ALL	1ST	UCAR T1	18120318
327140	463472	4.722643	0.000321	0	0	0	1-HR	ALL	1ST	UCAR T1	18032814
327240	463472	3.549029	0.000262	0	0	0	1-HR	ALL	1ST	UCAR T1	18032814
327340	463472	4.320853	0.00018	0	0	0	1-HR	ALL	1ST	UCAR T1	18041719
327440	463472	4.680309	0.000262	0	0	0	1-HR	ALL	1ST	UCAR T1	18030518
327540	463472	4.5776	0.000241	0	0	0	1-HR	ALL	1ST	UCAR T1	18030518
327640	463472	3.759856	0.000202	0	0	0	1-HR	ALL	1ST	UCAR T1	18111013
327740	463472	3.218236	0.000147	0	0	0	1-HR	ALL	1ST	UCAR T1	18102414
327840	463472	3.429535	0.000146	0	0	0	1-HR	ALL	1ST	UCAR T1	18102414
327940	463472	3.522215	0.000165	0	0	0	1-HR	ALL	1ST	UCAR T1	18101324
328040	463472	3.622374	0.000186	0	0	0	1-HR	ALL	1ST	UCAR T1	18032919

AERMOD DISPERSION MODEL VALIDATION STUDY SEPTEMBER 2019  
 Greater Male' Waste to Energy Project  
 Environmental Impact Assessment (EIA) for the Waste to Energy Facility in Thilafushi Island, Maldives

328140	463472	3.570751	0.000189	0	0	0	1-HR	ALL	1ST	UCAR T1	18032919
328240	463472	3.359861	0.000133	0	0	0	1-HR	ALL	1ST	UCAR T1	18101323
328340	463472	3.255895	0.000141	0	0	0	1-HR	ALL	1ST	UCAR T1	18111014
328440	463472	3.636773	0.00015	0	0	0	1-HR	ALL	1ST	UCAR T1	18111014
328540	463472	3.337322	0.000134	0	0	0	1-HR	ALL	1ST	UCAR T1	18111014
324540	463572	2.405147	0.000138	0	0	0	1-HR	ALL	1ST	UCAR T1	18110713
324640	463572	2.682704	0.00016	0	0	0	1-HR	ALL	1ST	UCAR T1	18110713
324740	463572	2.528436	0.000164	0	0	0	1-HR	ALL	1ST	UCAR T1	18032617
324840	463572	2.975423	0.000166	0	0	0	1-HR	ALL	1ST	UCAR T1	18032617
324940	463572	2.509155	0.000133	0	0	0	1-HR	ALL	1ST	UCAR T1	18032615
325040	463572	1.402745	0.000145	0	0	0	1-HR	ALL	1ST	UCAR T1	18032619
325140	463572	0.899006	0.000195	0	0	0	1-HR	ALL	1ST	UCAR T1	18032619
325240	463572	0.746062	0.000178	0	0	0	1-HR	ALL	1ST	UCAR T1	18021618
325340	463572	0.900784	0.000211	0	0	0	1-HR	ALL	1ST	UCAR T1	18032618
325440	463572	2.147473	0.000132	0	0	0	1-HR	ALL	1ST	UCAR T1	18041101
325540	463572	2.752828	0.000207	0	0	0	1-HR	ALL	1ST	UCAR T1	18110714
325640	463572	1.315505	0.000214	0	0	0	1-HR	ALL	1ST	UCAR T1	18110714

325740	463572	2.484053	0.000196	0	0	0	1-HR	ALL	1ST	UCAR T1	18041624
325840	463572	2.160347	0.000413	0	0	0	1-HR	ALL	1ST	UCAR T1	18041624
325940	463572	3.073478	0.00031	0	0	0	1-HR	ALL	1ST	UCAR T1	18030517
326040	463572	2.976604	0.000141	0	0	0	1-HR	ALL	1ST	UCAR T1	18110615
326140	463572	3.744847	0.00017	0	0	0	1-HR	ALL	1ST	UCAR T1	18110520
326240	463572	5.104329	0.00037	0	0	0	1-HR	ALL	1ST	UCAR T1	18031521
326340	463572	3.042754	0.000373	0	0	0	1-HR	ALL	1ST	UCAR T1	18041701
326440	463572	2.673897	0.000074	0	0	0	1-HR	ALL	1ST	UCAR T1	18031517
326540	463572	1.864376	0.000201	0	0	0	1-HR	ALL	1ST	UCAR T1	18110715
326640	463572	2.182082	0.000211	0	0	0	1-HR	ALL	1ST	UCAR T1	18032820
326740	463572	3.520645	0.000203	0	0	0	1-HR	ALL	1ST	UCAR T1	18032820
326840	463572	3.879529	0.000256	0	0	0	1-HR	ALL	1ST	UCAR T1	18021714
326940	463572	5.397342	0.00033	0	0	0	1-HR	ALL	1ST	UCAR T1	18120319
327040	463572	3.424153	0.000357	0	0	0	1-HR	ALL	1ST	UCAR T1	18120318
327140	463572	4.252809	0.000171	0	0	0	1-HR	ALL	1ST	UCAR T1	18101418
327240	463572	3.270177	0.000342	0	0	0	1-HR	ALL	1ST	UCAR T1	18032814
327340	463572	3.496904	0.00017	0	0	0	1-HR	ALL	1ST	UCAR T1	18081219

327440	463572	4.208072	0.000131	0	0	0	1-HR	ALL	1ST	UCAR T1	18041719
327540	463572	4.013932	0.000239	0	0	0	1-HR	ALL	1ST	UCAR T1	18030518
327640	463572	4.306151	0.000211	0	0	0	1-HR	ALL	1ST	UCAR T1	18030518
327740	463572	3.616307	0.000186	0	0	0	1-HR	ALL	1ST	UCAR T1	18111013
327840	463572	3.10486	0.000127	0	0	0	1-HR	ALL	1ST	UCAR T1	18102414
327940	463572	3.12224	0.00014	0	0	0	1-HR	ALL	1ST	UCAR T1	18102414
328040	463572	3.301659	0.000145	0	0	0	1-HR	ALL	1ST	UCAR T1	18101324
328140	463572	3.596	0.000141	0	0	0	1-HR	ALL	1ST	UCAR T1	18032919
328240	463572	3.117463	0.000179	0	0	0	1-HR	ALL	1ST	UCAR T1	18032919
328340	463572	3.444184	0.000152	0	0	0	1-HR	ALL	1ST	UCAR T1	18032919
328440	463572	3.053858	0.000128	0	0	0	1-HR	ALL	1ST	UCAR T1	18101323
328540	463572	3.163182	0.00013	0	0	0	1-HR	ALL	1ST	UCAR T1	18111014
324540	463672	2.479552	0.000138	0	0	0	1-HR	ALL	1ST	UCAR T1	18110713
324640	463672	2.926752	0.000157	0	0	0	1-HR	ALL	1ST	UCAR T1	18032617
324740	463672	2.921243	0.000133	0	0	0	1-HR	ALL	1ST	UCAR T1	18021619
324840	463672	2.112719	0.000127	0	0	0	1-HR	ALL	1ST	UCAR T1	18032615
324940	463672	1.036542	0.000154	0	0	0	1-HR	ALL	1ST	UCAR T1	18032619

AERMOD DISPERSION MODEL VALIDATION STUDY SEPTEMBER 2019  
 Greater Male' Waste to Energy Project  
 Environmental Impact Assessment (EIA) for the Waste to Energy Facility in Thilafushi Island, Maldives

325040	463672	0.786742	0.000175	0	0	0	1-HR	ALL	1ST	UCAR T1	18032619
325140	463672	0.673889	0.000169	0	0	0	1-HR	ALL	1ST	UCAR T1	18032620
325240	463672	0.854886	0.000191	0	0	0	1-HR	ALL	1ST	UCAR T1	18032618
325340	463672	2.208212	0.000122	0	0	0	1-HR	ALL	1ST	UCAR T1	18041101
325440	463672	2.899147	0.000176	0	0	0	1-HR	ALL	1ST	UCAR T1	18110714
325540	463672	1.651415	0.000212	0	0	0	1-HR	ALL	1ST	UCAR T1	18110714
325640	463672	2.447347	0.000181	0	0	0	1-HR	ALL	1ST	UCAR T1	18112614
325740	463672	2.498508	0.000345	0	0	0	1-HR	ALL	1ST	UCAR T1	18041624
325840	463672	3.161729	0.00036	0	0	0	1-HR	ALL	1ST	UCAR T1	18030517
325940	463672	2.517252	0.000116	0	0	0	1-HR	ALL	1ST	UCAR T1	18110518
326040	463672	3.642195	0.000112	0	0	0	1-HR	ALL	1ST	UCAR T1	18110520
326140	463672	3.416939	0.000108	0	0	0	1-HR	ALL	1ST	UCAR T1	18110520
326240	463672	4.326083	0.000404	0	0	0	1-HR	ALL	1ST	UCAR T1	18031521
326340	463672	3.290515	0.00031	0	0	0	1-HR	ALL	1ST	UCAR T1	18041701
326440	463672	2.909662	0.000071	0	0	0	1-HR	ALL	1ST	UCAR T1	18031517
326540	463672	1.986688	0.000186	0	0	0	1-HR	ALL	1ST	UCAR T1	18110715
326640	463672	2.459558	0.000178	0	0	0	1-HR	ALL	1ST	UCAR T1	18032820

AERMOD DISPERSION MODEL VALIDATION STUDY SEPTEMBER 2019  
 Greater Male' Waste to Energy Project  
 Environmental Impact Assessment (EIA) for the Waste to Energy Facility in Thilafushi Island, Maldives

326740	463672	3.513346	0.000214	0	0	0	1-HR	ALL	1ST	UCAR T1	18032820
326840	463672	4.246506	0.000241	0	0	0	1-HR	ALL	1ST	UCAR T1	18032821
326940	463672	4.721467	0.000241	0	0	0	1-HR	ALL	1ST	UCAR T1	18032817
327040	463672	3.54583	0.000323	0	0	0	1-HR	ALL	1ST	UCAR T1	18120318
327140	463672	3.416842	0.000228	0	0	0	1-HR	ALL	1ST	UCAR T1	18120318
327240	463672	4.085231	0.000224	0	0	0	1-HR	ALL	1ST	UCAR T1	18032814
327340	463672	3.052474	0.000283	0	0	0	1-HR	ALL	1ST	UCAR T1	18032814
327440	463672	3.446472	0.000167	0	0	0	1-HR	ALL	1ST	UCAR T1	18041719
327540	463672	4.074007	0.000126	0	0	0	1-HR	ALL	1ST	UCAR T1	18030518
327640	463672	3.819939	0.000217	0	0	0	1-HR	ALL	1ST	UCAR T1	18030518
327740	463672	4.037536	0.000186	0	0	0	1-HR	ALL	1ST	UCAR T1	18030518
327840	463672	3.453012	0.000172	0	0	0	1-HR	ALL	1ST	UCAR T1	18111013
327940	463672	2.996742	0.000119	0	0	0	1-HR	ALL	1ST	UCAR T1	18111013
328040	463672	3.061871	0.000132	0	0	0	1-HR	ALL	1ST	UCAR T1	18102414
328140	463672	3.172835	0.000117	0	0	0	1-HR	ALL	1ST	UCAR T1	18101324
328240	463672	3.34845	0.000135	0	0	0	1-HR	ALL	1ST	UCAR T1	18101324
328340	463672	3.242774	0.000153	0	0	0	1-HR	ALL	1ST	UCAR T1	18032919

328440	463672	3.20873	0.000159	0	0	0	1-HR	ALL	1ST	UCAR T1	18032919
328540	463672	3.173966	0.000118	0	0	0	1-HR	ALL	1ST	UCAR T1	18032919
324540	463772	3.056629	0.000134	0	0	0	1-HR	ALL	1ST	UCAR T1	18032617
324640	463772	2.647976	0.000111	0	0	0	1-HR	ALL	1ST	UCAR T1	18032615
324740	463772	1.685832	0.000113	0	0	0	1-HR	ALL	1ST	UCAR T1	18032615
324840	463772	0.785882	0.000155	0	0	0	1-HR	ALL	1ST	UCAR T1	18032619
324940	463772	0.681931	0.000156	0	0	0	1-HR	ALL	1ST	UCAR T1	18021618
325040	463772	0.60777	0.00016	0	0	0	1-HR	ALL	1ST	UCAR T1	18032620
325140	463772	0.928015	0.000173	0	0	0	1-HR	ALL	1ST	UCAR T1	18032618
325240	463772	2.236499	0.000113	0	0	0	1-HR	ALL	1ST	UCAR T1	18041101
325340	463772	2.982963	0.000151	0	0	0	1-HR	ALL	1ST	UCAR T1	18110714
325440	463772	1.941613	0.000203	0	0	0	1-HR	ALL	1ST	UCAR T1	18110714
325540	463772	2.24384	0.000179	0	0	0	1-HR	ALL	1ST	UCAR T1	18112614
325640	463772	2.527026	0.000251	0	0	0	1-HR	ALL	1ST	UCAR T1	18041624
325740	463772	2.626366	0.000311	0	0	0	1-HR	ALL	1ST	UCAR T1	18041624
325840	463772	2.926147	0.00022	0	0	0	1-HR	ALL	1ST	UCAR T1	18030517
325940	463772	3.212125	0.000122	0	0	0	1-HR	ALL	1ST	UCAR T1	18110615



AERMOD DISPERSION MODEL VALIDATION STUDY SEPTEMBER 2019  
 Greater Male' Waste to Energy Project  
 Environmental Impact Assessment (EIA) for the Waste to Energy Facility in Thilafushi Island, Maldives

326040	463772	3.633788	0.000148	0	0	0	1-HR	ALL	1ST	UCAR T1	18110520
326140	463772	3.734223	0.000148	0	0	0	1-HR	ALL	1ST	UCAR T1	18031521
326240	463772	3.31033	0.000361	0	0	0	1-HR	ALL	1ST	UCAR T1	18031521
326340	463772	3.269052	0.000234	0	0	0	1-HR	ALL	1ST	UCAR T1	18041701
326440	463772	3.032355	0.000067	0	0	0	1-HR	ALL	1ST	UCAR T1	18031517
326540	463772	2.07062	0.000172	0	0	0	1-HR	ALL	1ST	UCAR T1	18110715
326640	463772	2.66798	0.000151	0	0	0	1-HR	ALL	1ST	UCAR T1	18032820
326740	463772	3.318821	0.000215	0	0	0	1-HR	ALL	1ST	UCAR T1	18032820
326840	463772	4.094284	0.000222	0	0	0	1-HR	ALL	1ST	UCAR T1	18032821
326940	463772	4.340464	0.000186	0	0	0	1-HR	ALL	1ST	UCAR T1	18032817
327040	463772	4.627232	0.000284	0	0	0	1-HR	ALL	1ST	UCAR T1	18120319
327140	463772	3.220109	0.000284	0	0	0	1-HR	ALL	1ST	UCAR T1	18120318
327240	463772	3.495276	0.000139	0	0	0	1-HR	ALL	1ST	UCAR T1	18101418
327340	463772	3.244518	0.000272	0	0	0	1-HR	ALL	1ST	UCAR T1	18032814
327440	463772	3.197141	0.000198	0	0	0	1-HR	ALL	1ST	UCAR T1	18032814
327540	463772	3.641655	0.000162	0	0	0	1-HR	ALL	1ST	UCAR T1	18041719
327640	463772	3.824652	0.00013	0	0	0	1-HR	ALL	1ST	UCAR T1	18030518

327740	463772	3.626857	0.000196	0	0	0	1-HR	ALL	1ST	UCAR T1	18030518
327840	463772	3.782353	0.000165	0	0	0	1-HR	ALL	1ST	UCAR T1	18030518
327940	463772	3.284153	0.000159	0	0	0	1-HR	ALL	1ST	UCAR T1	18111013
328040	463772	2.853904	0.000115	0	0	0	1-HR	ALL	1ST	UCAR T1	18111013
328140	463772	2.949386	0.000121	0	0	0	1-HR	ALL	1ST	UCAR T1	18102414
328240	463772	2.945281	0.000109	0	0	0	1-HR	ALL	1ST	UCAR T1	18102414
328340	463772	2.98331	0.000129	0	0	0	1-HR	ALL	1ST	UCAR T1	18101324
328440	463772	3.230976	0.000121	0	0	0	1-HR	ALL	1ST	UCAR T1	18032919
328540	463772	2.791134	0.000149	0	0	0	1-HR	ALL	1ST	UCAR T1	18032919
324540	463872	2.263311	0.000109	0	0	0	1-HR	ALL	1ST	UCAR T1	18032615
324640	463872	1.295362	0.000113	0	0	0	1-HR	ALL	1ST	UCAR T1	18032619
324740	463872	0.719197	0.000149	0	0	0	1-HR	ALL	1ST	UCAR T1	18032619
324840	463872	0.588321	0.000144	0	0	0	1-HR	ALL	1ST	UCAR T1	18021618
324940	463872	0.547899	0.000151	0	0	0	1-HR	ALL	1ST	UCAR T1	18032618
325040	463872	0.98537	0.000156	0	0	0	1-HR	ALL	1ST	UCAR T1	18032618
325140	463872	2.239621	0.000105	0	0	0	1-HR	ALL	1ST	UCAR T1	18041101
325240	463872	3.017963	0.00013	0	0	0	1-HR	ALL	1ST	UCAR T1	18110714

AERMOD DISPERSION MODEL VALIDATION STUDY SEPTEMBER 2019  
 Greater Male' Waste to Energy Project  
 Environmental Impact Assessment (EIA) for the Waste to Energy Facility in Thilafushi Island, Maldives

325340	463872	2.177678	0.00019	0	0	0	1-HR	ALL	1ST	UCAR T1	18110714
325440	463872	1.967691	0.000165	0	0	0	1-HR	ALL	1ST	UCAR T1	18112614
325540	463872	2.737406	0.000168	0	0	0	1-HR	ALL	1ST	UCAR T1	18041624
325640	463872	2.507208	0.000306	0	0	0	1-HR	ALL	1ST	UCAR T1	18041624
325740	463872	3.133385	0.000277	0	0	0	1-HR	ALL	1ST	UCAR T1	18030517
325840	463872	2.636008	0.000102	0	0	0	1-HR	ALL	1ST	UCAR T1	18110518
325940	463872	3.035709	0.000096	0	0	0	1-HR	ALL	1ST	UCAR T1	18110615
326040	463872	3.122504	0.000129	0	0	0	1-HR	ALL	1ST	UCAR T1	18110520
326140	463872	3.865571	0.000221	0	0	0	1-HR	ALL	1ST	UCAR T1	18031521
326240	463872	2.450814	0.000283	0	0	0	1-HR	ALL	1ST	UCAR T1	18031521
326340	463872	3.0689	0.000166	0	0	0	1-HR	ALL	1ST	UCAR T1	18041701
326440	463872	3.066513	0.000062	0	0	0	1-HR	ALL	1ST	UCAR T1	18031517
326540	463872	2.122823	0.000161	0	0	0	1-HR	ALL	1ST	UCAR T1	18110715
326640	463872	2.814813	0.000147	0	0	0	1-HR	ALL	1ST	UCAR T1	18021716
326740	463872	3.025597	0.000209	0	0	0	1-HR	ALL	1ST	UCAR T1	18032820
326840	463872	3.625323	0.000192	0	0	0	1-HR	ALL	1ST	UCAR T1	18032821
326940	463872	3.618879	0.000175	0	0	0	1-HR	ALL	1ST	UCAR T1	18021714

AERMOD DISPERSION MODEL VALIDATION STUDY SEPTEMBER 2019  
 Greater Male' Waste to Energy Project  
 Environmental Impact Assessment (EIA) for the Waste to Energy Facility in Thilafushi Island, Maldives

327040	463872	4.800374	0.000252	0	0	0	1-HR	ALL	1ST	UCAR T1	18120319
327140	463872	3.25264	0.000279	0	0	0	1-HR	ALL	1ST	UCAR T1	18120318
327240	463872	3.262914	0.00018	0	0	0	1-HR	ALL	1ST	UCAR T1	18120318
327340	463872	3.500983	0.000159	0	0	0	1-HR	ALL	1ST	UCAR T1	18032814
327440	463872	2.986834	0.000261	0	0	0	1-HR	ALL	1ST	UCAR T1	18032814
327540	463872	3.136742	0.000128	0	0	0	1-HR	ALL	1ST	UCAR T1	18081219
327640	463872	3.650094	0.000141	0	0	0	1-HR	ALL	1ST	UCAR T1	18041719
327740	463872	3.527001	0.00013	0	0	0	1-HR	ALL	1ST	UCAR T1	18030518
327840	463872	3.416963	0.000178	0	0	0	1-HR	ALL	1ST	UCAR T1	18030518
327940	463872	3.648936	0.000148	0	0	0	1-HR	ALL	1ST	UCAR T1	18030518
328040	463872	3.117922	0.000148	0	0	0	1-HR	ALL	1ST	UCAR T1	18111013
328140	463872	2.796529	0.000111	0	0	0	1-HR	ALL	1ST	UCAR T1	18111013
328240	463872	2.785434	0.000111	0	0	0	1-HR	ALL	1ST	UCAR T1	18102414
328340	463872	2.841818	0.000107	0	0	0	1-HR	ALL	1ST	UCAR T1	18102414
328440	463872	3.05887	0.000114	0	0	0	1-HR	ALL	1ST	UCAR T1	18101324
328540	463872	3.064221	0.00011	0	0	0	1-HR	ALL	1ST	UCAR T1	18101324
324540	463972	0.969349	0.000119	0	0	0	1-HR	ALL	1ST	UCAR T1	18032619

AERMOD DISPERSION MODEL VALIDATION STUDY SEPTEMBER 2019  
 Greater Male' Waste to Energy Project  
 Environmental Impact Assessment (EIA) for the Waste to Energy Facility in Thilafushi Island, Maldives

324640	463972	0.650703	0.000139	0	0	0	1-HR	ALL	1ST	UCAR T1	18032619
324740	463972	0.506897	0.000131	0	0	0	1-HR	ALL	1ST	UCAR T1	18021618
324840	463972	0.496159	0.000145	0	0	0	1-HR	ALL	1ST	UCAR T1	18032618
324940	463972	1.028637	0.000142	0	0	0	1-HR	ALL	1ST	UCAR T1	18032618
325040	463972	2.22367	0.000098	0	0	0	1-HR	ALL	1ST	UCAR T1	18041101
325140	463972	3.015824	0.000113	0	0	0	1-HR	ALL	1ST	UCAR T1	18110714
325240	463972	2.359954	0.000175	0	0	0	1-HR	ALL	1ST	UCAR T1	18110714
325340	463972	1.678509	0.000144	0	0	0	1-HR	ALL	1ST	UCAR T1	18112614
325440	463972	2.727663	0.000123	0	0	0	1-HR	ALL	1ST	UCAR T1	18112614
325540	463972	2.699343	0.000259	0	0	0	1-HR	ALL	1ST	UCAR T1	18041624
325640	463972	2.799626	0.000265	0	0	0	1-HR	ALL	1ST	UCAR T1	18030517
325740	463972	2.688861	0.000162	0	0	0	1-HR	ALL	1ST	UCAR T1	18030517
325840	463972	3.26293	0.000106	0	0	0	1-HR	ALL	1ST	UCAR T1	18110615
325940	463972	3.251454	0.000117	0	0	0	1-HR	ALL	1ST	UCAR T1	18110520
326040	463972	3.254181	0.000087	0	0	0	1-HR	ALL	1ST	UCAR T1	18122014
326140	463972	3.567372	0.000266	0	0	0	1-HR	ALL	1ST	UCAR T1	18031521
326240	463972	2.756515	0.000254	0	0	0	1-HR	ALL	1ST	UCAR T1	18041701

AERMOD DISPERSION MODEL VALIDATION STUDY SEPTEMBER 2019  
 Greater Male' Waste to Energy Project  
 Environmental Impact Assessment (EIA) for the Waste to Energy Facility in Thilafushi Island, Maldives

326340	463972	2.773211	0.000113	0	0	0	1-HR	ALL	1ST	UCAR T1	18041701
326440	463972	3.082068	0.000057	0	0	0	1-HR	ALL	1ST	UCAR T1	18031517
326540	463972	2.149431	0.000151	0	0	0	1-HR	ALL	1ST	UCAR T1	18110715
326640	463972	2.909534	0.000147	0	0	0	1-HR	ALL	1ST	UCAR T1	18021716
326740	463972	2.695528	0.000199	0	0	0	1-HR	ALL	1ST	UCAR T1	18032820
326840	463972	3.192114	0.000158	0	0	0	1-HR	ALL	1ST	UCAR T1	18032821
326940	463972	3.778057	0.000195	0	0	0	1-HR	ALL	1ST	UCAR T1	18021714
327040	463972	4.227938	0.000197	0	0	0	1-HR	ALL	1ST	UCAR T1	18032817
327140	463972	3.58688	0.000243	0	0	0	1-HR	ALL	1ST	UCAR T1	18032815
327240	463972	2.912339	0.000229	0	0	0	1-HR	ALL	1ST	UCAR T1	18120318
327340	463972	3.135764	0.00012	0	0	0	1-HR	ALL	1ST	UCAR T1	18080117
327440	463972	3.014073	0.000209	0	0	0	1-HR	ALL	1ST	UCAR T1	18032814
327540	463972	2.90887	0.000213	0	0	0	1-HR	ALL	1ST	UCAR T1	18032814
327640	463972	3.257073	0.000132	0	0	0	1-HR	ALL	1ST	UCAR T1	18081219
327740	463972	3.500603	0.000114	0	0	0	1-HR	ALL	1ST	UCAR T1	18041719
327840	463972	3.219988	0.000127	0	0	0	1-HR	ALL	1ST	UCAR T1	18030518
327940	463972	3.205108	0.000161	0	0	0	1-HR	ALL	1ST	UCAR T1	18030518

AERMOD DISPERSION MODEL VALIDATION STUDY SEPTEMBER 2019  
 Greater Male' Waste to Energy Project  
 Environmental Impact Assessment (EIA) for the Waste to Energy Facility in Thilafushi Island, Maldives

328040	463972	3.570318	0.000133	0	0	0	1-HR	ALL	1ST	UCAR T1	18030518
328140	463972	2.958785	0.000137	0	0	0	1-HR	ALL	1ST	UCAR T1	18111013
328240	463972	2.726741	0.000107	0	0	0	1-HR	ALL	1ST	UCAR T1	18111013
328340	463972	2.638486	0.0001	0	0	0	1-HR	ALL	1ST	UCAR T1	18102414
328440	463972	2.827247	0.000104	0	0	0	1-HR	ALL	1ST	UCAR T1	18102414
328540	463972	3.01938	0.000094	0	0	0	1-HR	ALL	1ST	UCAR T1	18101324
324540	464072	0.584505	0.000127	0	0	0	1-HR	ALL	1ST	UCAR T1	18032619
324640	464072	0.437183	0.000122	0	0	0	1-HR	ALL	1ST	UCAR T1	18110515
324740	464072	0.450155	0.000139	0	0	0	1-HR	ALL	1ST	UCAR T1	18032618
324840	464072	1.059685	0.000129	0	0	0	1-HR	ALL	1ST	UCAR T1	18032618
324940	464072	2.193552	0.000092	0	0	0	1-HR	ALL	1ST	UCAR T1	18041101
325040	464072	2.986113	0.000104	0	0	0	1-HR	ALL	1ST	UCAR T1	18041101
325140	464072	2.493098	0.00016	0	0	0	1-HR	ALL	1ST	UCAR T1	18110714
325240	464072	1.407805	0.000127	0	0	0	1-HR	ALL	1ST	UCAR T1	18110714
325340	464072	2.568881	0.000134	0	0	0	1-HR	ALL	1ST	UCAR T1	18112614
325440	464072	2.622704	0.000198	0	0	0	1-HR	ALL	1ST	UCAR T1	18041624
325540	464072	2.456368	0.000246	0	0	0	1-HR	ALL	1ST	UCAR T1	18041624

AERMOD DISPERSION MODEL VALIDATION STUDY SEPTEMBER 2019  
 Greater Male' Waste to Energy Project  
 Environmental Impact Assessment (EIA) for the Waste to Energy Facility in Thilafushi Island, Maldives

325640	464072	2.955722	0.000213	0	0	0	1-HR	ALL	1ST	UCAR T1	18030517
325740	464072	2.644616	0.000091	0	0	0	1-HR	ALL	1ST	UCAR T1	18110518
325840	464072	3.092802	0.000092	0	0	0	1-HR	ALL	1ST	UCAR T1	18110615
325940	464072	2.943025	0.000126	0	0	0	1-HR	ALL	1ST	UCAR T1	18110520
326040	464072	2.945763	0.000096	0	0	0	1-HR	ALL	1ST	UCAR T1	18031521
326140	464072	3.036407	0.000273	0	0	0	1-HR	ALL	1ST	UCAR T1	18031521
326240	464072	3.029692	0.000248	0	0	0	1-HR	ALL	1ST	UCAR T1	18041701
326340	464072	2.442377	0.000075	0	0	0	1-HR	ALL	1ST	UCAR T1	18041701
326440	464072	3.09679	0.000058	0	0	0	1-HR	ALL	1ST	UCAR T1	18021717
326540	464072	2.155804	0.000142	0	0	0	1-HR	ALL	1ST	UCAR T1	18110715
326640	464072	2.961728	0.000145	0	0	0	1-HR	ALL	1ST	UCAR T1	18021716
326740	464072	2.36636	0.000186	0	0	0	1-HR	ALL	1ST	UCAR T1	18032820
326840	464072	3.214447	0.000129	0	0	0	1-HR	ALL	1ST	UCAR T1	18041702
326940	464072	3.97041	0.000184	0	0	0	1-HR	ALL	1ST	UCAR T1	18021714
327040	464072	3.770659	0.000164	0	0	0	1-HR	ALL	1ST	UCAR T1	18032817
327140	464072	4.161777	0.000234	0	0	0	1-HR	ALL	1ST	UCAR T1	18120319
327240	464072	3.096034	0.000237	0	0	0	1-HR	ALL	1ST	UCAR T1	18120318



AERMOD DISPERSION MODEL VALIDATION STUDY SEPTEMBER 2019  
 Greater Male' Waste to Energy Project  
 Environmental Impact Assessment (EIA) for the Waste to Energy Facility in Thilafushi Island, Maldives

327340	464072	3.048145	0.000145	0	0	0	1-HR	ALL	1ST	UCAR T1	18120318
327440	464072	3.019646	0.000131	0	0	0	1-HR	ALL	1ST	UCAR T1	18101418
327540	464072	2.951623	0.000223	0	0	0	1-HR	ALL	1ST	UCAR T1	18032814
327640	464072	2.942218	0.000155	0	0	0	1-HR	ALL	1ST	UCAR T1	18032814
327740	464072	3.164825	0.00013	0	0	0	1-HR	ALL	1ST	UCAR T1	18041719
327840	464072	3.260359	0.000088	0	0	0	1-HR	ALL	1ST	UCAR T1	18041719
327940	464072	2.924403	0.000123	0	0	0	1-HR	ALL	1ST	UCAR T1	18030518
328040	464072	3.150046	0.000146	0	0	0	1-HR	ALL	1ST	UCAR T1	18030518
328140	464072	3.478154	0.000123	0	0	0	1-HR	ALL	1ST	UCAR T1	18111013
328240	464072	2.808934	0.000128	0	0	0	1-HR	ALL	1ST	UCAR T1	18111013
328340	464072	2.671594	0.000102	0	0	0	1-HR	ALL	1ST	UCAR T1	18111013
328440	464072	2.582338	0.00009	0	0	0	1-HR	ALL	1ST	UCAR T1	18102414
328540	464072	2.754442	0.000099	0	0	0	1-HR	ALL	1ST	UCAR T1	18102414
324540	464172	0.428246	0.000114	0	0	0	1-HR	ALL	1ST	UCAR T1	18110515
324640	464172	0.409462	0.000131	0	0	0	1-HR	ALL	1ST	UCAR T1	18032618
324740	464172	1.080352	0.000117	0	0	0	1-HR	ALL	1ST	UCAR T1	18032618
324840	464172	2.153149	0.000087	0	0	0	1-HR	ALL	1ST	UCAR T1	18041101

AERMOD DISPERSION MODEL VALIDATION STUDY SEPTEMBER 2019  
 Greater Male' Waste to Energy Project  
 Environmental Impact Assessment (EIA) for the Waste to Energy Facility in Thilafushi Island, Maldives

324940	464172	2.936418	0.0001	0	0	0	1-HR	ALL	1ST	UCAR T1	18041101
325040	464172	2.583612	0.000146	0	0	0	1-HR	ALL	1ST	UCAR T1	18110714
325140	464172	1.369026	0.00013	0	0	0	1-HR	ALL	1ST	UCAR T1	18110714
325240	464172	2.327975	0.000136	0	0	0	1-HR	ALL	1ST	UCAR T1	18112614
325340	464172	2.686188	0.000142	0	0	0	1-HR	ALL	1ST	UCAR T1	18041624
325440	464172	2.583769	0.000235	0	0	0	1-HR	ALL	1ST	UCAR T1	18041624
325540	464172	2.782984	0.000221	0	0	0	1-HR	ALL	1ST	UCAR T1	18030517
325640	464172	2.431533	0.000124	0	0	0	1-HR	ALL	1ST	UCAR T1	18030517
325740	464172	3.203758	0.000094	0	0	0	1-HR	ALL	1ST	UCAR T1	18110615
325840	464172	2.818214	0.000089	0	0	0	1-HR	ALL	1ST	UCAR T1	18110520
325940	464172	2.95106	0.000101	0	0	0	1-HR	ALL	1ST	UCAR T1	18110520
326040	464172	3.018988	0.000141	0	0	0	1-HR	ALL	1ST	UCAR T1	18031521
326140	464172	2.81407	0.00025	0	0	0	1-HR	ALL	1ST	UCAR T1	18031521
326240	464172	3.135417	0.000223	0	0	0	1-HR	ALL	1ST	UCAR T1	18041701
326340	464172	2.316378	0.000049	0	0	0	1-HR	ALL	1ST	UCAR T1	18041701
326440	464172	3.069276	0.000061	0	0	0	1-HR	ALL	1ST	UCAR T1	18021717
326540	464172	2.146453	0.000134	0	0	0	1-HR	ALL	1ST	UCAR T1	18110715

AERMOD DISPERSION MODEL VALIDATION STUDY SEPTEMBER 2019  
 Greater Male' Waste to Energy Project  
 Environmental Impact Assessment (EIA) for the Waste to Energy Facility in Thilafushi Island, Maldives

326640	464172	2.980119	0.000142	0	0	0	1-HR	ALL	1ST	UCAR T1	18021716
326740	464172	2.222176	0.000171	0	0	0	1-HR	ALL	1ST	UCAR T1	18032820
326840	464172	3.365154	0.000126	0	0	0	1-HR	ALL	1ST	UCAR T1	18032820
326940	464172	3.866009	0.000173	0	0	0	1-HR	ALL	1ST	UCAR T1	18032821
327040	464172	3.342076	0.000122	0	0	0	1-HR	ALL	1ST	UCAR T1	18032823
327140	464172	4.154785	0.0002	0	0	0	1-HR	ALL	1ST	UCAR T1	18120319
327240	464172	2.788384	0.000222	0	0	0	1-HR	ALL	1ST	UCAR T1	18032815
327340	464172	2.667758	0.000186	0	0	0	1-HR	ALL	1ST	UCAR T1	18120318
327440	464172	2.960249	0.000106	0	0	0	1-HR	ALL	1ST	UCAR T1	18080117
327540	464172	2.797035	0.000159	0	0	0	1-HR	ALL	1ST	UCAR T1	18032814
327640	464172	3.005775	0.000204	0	0	0	1-HR	ALL	1ST	UCAR T1	18032814
327740	464172	2.808239	0.000104	0	0	0	1-HR	ALL	1ST	UCAR T1	18032814
327840	464172	2.987818	0.000126	0	0	0	1-HR	ALL	1ST	UCAR T1	18041719
327940	464172	2.978035	0.000075	0	0	0	1-HR	ALL	1ST	UCAR T1	18032219
328040	464172	2.79081	0.000117	0	0	0	1-HR	ALL	1ST	UCAR T1	18030518
328140	464172	3.143292	0.000133	0	0	0	1-HR	ALL	1ST	UCAR T1	18030518
328240	464172	3.377697	0.000114	0	0	0	1-HR	ALL	1ST	UCAR T1	18111013

AERMOD DISPERSION MODEL VALIDATION STUDY SEPTEMBER 2019  
 Greater Male' Waste to Energy Project  
 Environmental Impact Assessment (EIA) for the Waste to Energy Facility in Thilafushi Island, Maldives

328340	464172	2.6692	0.00012	0	0	0	1-HR	ALL	1ST	UCAR T1	18111013
328440	464172	2.61748	0.000098	0	0	0	1-HR	ALL	1ST	UCAR T1	18111013
328540	464172	2.547657	0.00008	0	0	0	1-HR	ALL	1ST	UCAR T1	18102414
324540	464272	0.437467	0.000124	0	0	0	1-HR	ALL	1ST	UCAR T1	18032618
324640	464272	1.092337	0.000107	0	0	0	1-HR	ALL	1ST	UCAR T1	18032618
324740	464272	2.105494	0.000082	0	0	0	1-HR	ALL	1ST	UCAR T1	18041101
324840	464272	2.872633	0.000096	0	0	0	1-HR	ALL	1ST	UCAR T1	18041101
324940	464272	2.638397	0.000133	0	0	0	1-HR	ALL	1ST	UCAR T1	18110714
325040	464272	1.53919	0.00013	0	0	0	1-HR	ALL	1ST	UCAR T1	18110714
325140	464272	2.054691	0.000131	0	0	0	1-HR	ALL	1ST	UCAR T1	18112614
325240	464272	2.70601	0.000097	0	0	0	1-HR	ALL	1ST	UCAR T1	18041624
325340	464272	2.683897	0.000201	0	0	0	1-HR	ALL	1ST	UCAR T1	18041624
325440	464272	2.621636	0.000197	0	0	0	1-HR	ALL	1ST	UCAR T1	18030517
325540	464272	2.720014	0.000166	0	0	0	1-HR	ALL	1ST	UCAR T1	18030517
325640	464272	2.587099	0.000083	0	0	0	1-HR	ALL	1ST	UCAR T1	18110518
325740	464272	3.122943	0.000087	0	0	0	1-HR	ALL	1ST	UCAR T1	18110615
325840	464272	2.734057	0.00011	0	0	0	1-HR	ALL	1ST	UCAR T1	18110520

AERMOD DISPERSION MODEL VALIDATION STUDY SEPTEMBER 2019  
 Greater Male' Waste to Energy Project  
 Environmental Impact Assessment (EIA) for the Waste to Energy Facility in Thilafushi Island, Maldives

325940	464272	2.962589	0.000075	0	0	0	1-HR	ALL	1ST	UCAR T1	18122014
326040	464272	2.92675	0.000177	0	0	0	1-HR	ALL	1ST	UCAR T1	18031521
326140	464272	2.652368	0.00021	0	0	0	1-HR	ALL	1ST	UCAR T1	18031521
326240	464272	3.102625	0.000188	0	0	0	1-HR	ALL	1ST	UCAR T1	18041701
326340	464272	2.485916	0.000043	0	0	0	1-HR	ALL	1ST	UCAR T1	18031517
326440	464272	3.011112	0.000064	0	0	0	1-HR	ALL	1ST	UCAR T1	18021717
326540	464272	2.125077	0.000127	0	0	0	1-HR	ALL	1ST	UCAR T1	18110715
326640	464272	2.972202	0.000138	0	0	0	1-HR	ALL	1ST	UCAR T1	18021716
326740	464272	2.372979	0.000157	0	0	0	1-HR	ALL	1ST	UCAR T1	18032820
326840	464272	3.377315	0.000134	0	0	0	1-HR	ALL	1ST	UCAR T1	18032820
326940	464272	3.557011	0.000157	0	0	0	1-HR	ALL	1ST	UCAR T1	18032821
327040	464272	3.044643	0.000146	0	0	0	1-HR	ALL	1ST	UCAR T1	18021714
327140	464272	3.700463	0.000165	0	0	0	1-HR	ALL	1ST	UCAR T1	18032817
327240	464272	3.358909	0.000191	0	0	0	1-HR	ALL	1ST	UCAR T1	18120319
327340	464272	2.897557	0.000201	0	0	0	1-HR	ALL	1ST	UCAR T1	18120318
327440	464272	2.819196	0.000119	0	0	0	1-HR	ALL	1ST	UCAR T1	18120318
327540	464272	2.804348	0.000115	0	0	0	1-HR	ALL	1ST	UCAR T1	18101418

AERMOD DISPERSION MODEL VALIDATION STUDY SEPTEMBER 2019  
 Greater Male' Waste to Energy Project  
 Environmental Impact Assessment (EIA) for the Waste to Energy Facility in Thilafushi Island, Maldives

327640	464272	2.78425	0.000183	0	0	0	1-HR	ALL	1ST	UCAR T1	18032814
327740	464272	2.765986	0.000166	0	0	0	1-HR	ALL	1ST	UCAR T1	18032814
327840	464272	2.922567	0.000109	0	0	0	1-HR	ALL	1ST	UCAR T1	18081219
327940	464272	2.972571	0.000115	0	0	0	1-HR	ALL	1ST	UCAR T1	18041719
328040	464272	2.71605	0.000072	0	0	0	1-HR	ALL	1ST	UCAR T1	18030518
328140	464272	2.710423	0.000111	0	0	0	1-HR	ALL	1ST	UCAR T1	18030518
328240	464272	3.114572	0.000122	0	0	0	1-HR	ALL	1ST	UCAR T1	18030518
328340	464272	3.272757	0.000107	0	0	0	1-HR	ALL	1ST	UCAR T1	18111013
328440	464272	2.539633	0.000112	0	0	0	1-HR	ALL	1ST	UCAR T1	18111013
328540	464272	2.549255	0.000094	0	0	0	1-HR	ALL	1ST	UCAR T1	18111013
324540	464372	1.097154	0.000098	0	0	0	1-HR	ALL	1ST	UCAR T1	18032618
324640	464372	2.052933	0.000078	0	0	0	1-HR	ALL	1ST	UCAR T1	18041101
324740	464372	2.799282	0.000092	0	0	0	1-HR	ALL	1ST	UCAR T1	18041101
324840	464372	2.663989	0.00012	0	0	0	1-HR	ALL	1ST	UCAR T1	18110714
324940	464372	1.683821	0.000127	0	0	0	1-HR	ALL	1ST	UCAR T1	18110714
325040	464372	1.781001	0.000121	0	0	0	1-HR	ALL	1ST	UCAR T1	18112614
325140	464372	2.604327	0.000097	0	0	0	1-HR	ALL	1ST	UCAR T1	18112614

325240	464372	2.592739	0.000159	0	0	0	1-HR	ALL	1ST	UCAR T1	18041624
325340	464372	2.464886	0.000198	0	0	0	1-HR	ALL	1ST	UCAR T1	18041624
325440	464372	2.661535	0.000182	0	0	0	1-HR	ALL	1ST	UCAR T1	18030517
325540	464372	2.454212	0.000097	0	0	0	1-HR	ALL	1ST	UCAR T1	18030517
325640	464372	3.084273	0.000084	0	0	0	1-HR	ALL	1ST	UCAR T1	18110615
325740	464372	2.565307	0.000066	0	0	0	1-HR	ALL	1ST	UCAR T1	18110520
325840	464372	2.495475	0.000105	0	0	0	1-HR	ALL	1ST	UCAR T1	18110520
325940	464372	2.879596	0.000076	0	0	0	1-HR	ALL	1ST	UCAR T1	18122014
326040	464372	2.702054	0.000196	0	0	0	1-HR	ALL	1ST	UCAR T1	18031521
326140	464372	2.365896	0.000175	0	0	0	1-HR	ALL	1ST	UCAR T1	18041701
326240	464372	2.968713	0.00015	0	0	0	1-HR	ALL	1ST	UCAR T1	18041701
326340	464372	2.600669	0.000043	0	0	0	1-HR	ALL	1ST	UCAR T1	18031517
326440	464372	2.931537	0.000065	0	0	0	1-HR	ALL	1ST	UCAR T1	18021717
326540	464372	2.094662	0.00012	0	0	0	1-HR	ALL	1ST	UCAR T1	18110715
326640	464372	2.944193	0.000134	0	0	0	1-HR	ALL	1ST	UCAR T1	18021716
326740	464372	2.476098	0.000142	0	0	0	1-HR	ALL	1ST	UCAR T1	18032820
326840	464372	3.282729	0.000138	0	0	0	1-HR	ALL	1ST	UCAR T1	18032820

AERMOD DISPERSION MODEL VALIDATION STUDY SEPTEMBER 2019  
 Greater Male' Waste to Energy Project  
 Environmental Impact Assessment (EIA) for the Waste to Energy Facility in Thilafushi Island, Maldives

326940	464372	3.137187	0.000138	0	0	0	1-HR	ALL	1ST	UCAR T1	18032821
327040	464372	3.36735	0.000156	0	0	0	1-HR	ALL	1ST	UCAR T1	18021714
327140	464372	3.236979	0.000145	0	0	0	1-HR	ALL	1ST	UCAR T1	18032817
327240	464372	3.66731	0.000195	0	0	0	1-HR	ALL	1ST	UCAR T1	18120319
327340	464372	2.763919	0.000191	0	0	0	1-HR	ALL	1ST	UCAR T1	18032815
327440	464372	2.598708	0.000153	0	0	0	1-HR	ALL	1ST	UCAR T1	18120318
327540	464372	2.76752	0.000094	0	0	0	1-HR	ALL	1ST	UCAR T1	18080117
327640	464372	2.685478	0.000121	0	0	0	1-HR	ALL	1ST	UCAR T1	18032814
327740	464372	3.011072	0.000183	0	0	0	1-HR	ALL	1ST	UCAR T1	18032814
327840	464372	2.702345	0.000124	0	0	0	1-HR	ALL	1ST	UCAR T1	18032814
327940	464372	2.888888	0.000107	0	0	0	1-HR	ALL	1ST	UCAR T1	18081219
328040	464372	2.876071	0.000098	0	0	0	1-HR	ALL	1ST	UCAR T1	18041719
328140	464372	2.702893	0.000073	0	0	0	1-HR	ALL	1ST	UCAR T1	18030518
328240	464372	2.615904	0.000105	0	0	0	1-HR	ALL	1ST	UCAR T1	18030518
328340	464372	3.069678	0.000111	0	0	0	1-HR	ALL	1ST	UCAR T1	18030518
328440	464372	3.166077	0.0001	0	0	0	1-HR	ALL	1ST	UCAR T1	18111013
328540	464372	2.489841	0.000105	0	0	0	1-HR	ALL	1ST	UCAR T1	18111013



324540	464472	1.997267	0.000074	0	0	0	1-HR	ALL	1ST	UCAR T1	18041101
324640	464472	2.7198	0.000088	0	0	0	1-HR	ALL	1ST	UCAR T1	18041101
324740	464472	2.666207	0.000109	0	0	0	1-HR	ALL	1ST	UCAR T1	18110714
324840	464472	1.802867	0.000122	0	0	0	1-HR	ALL	1ST	UCAR T1	18110714
324940	464472	1.524968	0.000108	0	0	0	1-HR	ALL	1ST	UCAR T1	18112614
325040	464472	2.424337	0.000105	0	0	0	1-HR	ALL	1ST	UCAR T1	18112614
325140	464472	2.512465	0.000119	0	0	0	1-HR	ALL	1ST	UCAR T1	18041624
325240	464472	2.518284	0.000186	0	0	0	1-HR	ALL	1ST	UCAR T1	18041624
325340	464472	2.633716	0.000173	0	0	0	1-HR	ALL	1ST	UCAR T1	18030517
325440	464472	2.472963	0.00013	0	0	0	1-HR	ALL	1ST	UCAR T1	18030517
325540	464472	2.564862	0.000075	0	0	0	1-HR	ALL	1ST	UCAR T1	18110518
325640	464472	3.067462	0.000081	0	0	0	1-HR	ALL	1ST	UCAR T1	18110615
325740	464472	2.463277	0.00009	0	0	0	1-HR	ALL	1ST	UCAR T1	18110520
325840	464472	2.755761	0.000081	0	0	0	1-HR	ALL	1ST	UCAR T1	18110520
325940	464472	3.04204	0.000095	0	0	0	1-HR	ALL	1ST	UCAR T1	18031521
326040	464472	2.748681	0.000196	0	0	0	1-HR	ALL	1ST	UCAR T1	18031521
326140	464472	2.485672	0.000184	0	0	0	1-HR	ALL	1ST	UCAR T1	18041701

AERMOD DISPERSION MODEL VALIDATION STUDY SEPTEMBER 2019  
 Greater Male' Waste to Energy Project  
 Environmental Impact Assessment (EIA) for the Waste to Energy Facility in Thilafushi Island, Maldives

326240	464472	2.769542	0.000116	0	0	0	1-HR	ALL	1ST	UCAR T1	18041701
326340	464472	2.667131	0.000043	0	0	0	1-HR	ALL	1ST	UCAR T1	18031517
326440	464472	2.837704	0.000067	0	0	0	1-HR	ALL	1ST	UCAR T1	18021717
326540	464472	2.057591	0.000115	0	0	0	1-HR	ALL	1ST	UCAR T1	18110715
326640	464472	2.901141	0.00013	0	0	0	1-HR	ALL	1ST	UCAR T1	18021716
326740	464472	2.537073	0.000128	0	0	0	1-HR	ALL	1ST	UCAR T1	18032820
326840	464472	3.113777	0.000138	0	0	0	1-HR	ALL	1ST	UCAR T1	18032820
326940	464472	2.847787	0.000117	0	0	0	1-HR	ALL	1ST	UCAR T1	18032821
327040	464472	3.48575	0.000148	0	0	0	1-HR	ALL	1ST	UCAR T1	18021714
327140	464472	2.98431	0.00011	0	0	0	1-HR	ALL	1ST	UCAR T1	18032817
327240	464472	3.596302	0.000163	0	0	0	1-HR	ALL	1ST	UCAR T1	18120319
327340	464472	2.628726	0.000179	0	0	0	1-HR	ALL	1ST	UCAR T1	18032815
327440	464472	2.657622	0.00017	0	0	0	1-HR	ALL	1ST	UCAR T1	18120318
327540	464472	2.728938	0.000105	0	0	0	1-HR	ALL	1ST	UCAR T1	18032819
327640	464472	2.696308	0.000102	0	0	0	1-HR	ALL	1ST	UCAR T1	18101418
327740	464472	2.6205	0.000147	0	0	0	1-HR	ALL	1ST	UCAR T1	18032814
327840	464472	2.937079	0.000163	0	0	0	1-HR	ALL	1ST	UCAR T1	18032814

AERMOD DISPERSION MODEL VALIDATION STUDY SEPTEMBER 2019  
 Greater Male' Waste to Energy Project  
 Environmental Impact Assessment (EIA) for the Waste to Energy Facility in Thilafushi Island, Maldives

327940	464472	2.60067	0.000087	0	0	0	1-HR	ALL	1ST	UCAR T1	18032814
328040	464472	2.749976	0.000106	0	0	0	1-HR	ALL	1ST	UCAR T1	18041719
328140	464472	2.726917	0.000081	0	0	0	1-HR	ALL	1ST	UCAR T1	18041719
328240	464472	2.648025	0.000073	0	0	0	1-HR	ALL	1ST	UCAR T1	18030518
328340	464472	2.522547	0.000099	0	0	0	1-HR	ALL	1ST	UCAR T1	18030518
328440	464472	3.013151	0.000102	0	0	0	1-HR	ALL	1ST	UCAR T1	18030518
328540	464472	3.059609	0.000093	0	0	0	1-HR	ALL	1ST	UCAR T1	18111013
*****	*****	*****									
Produced by:	AERMOD View V	er. 9.7.0									
*****	*****	*****									
Chemical Nam	e: TSP										
SRCEMISS S1	0.0804										
SRCEMISS S2	0.0804										
SRCEMISS GSS	TACK 0.2769										
*****	*****	*****									
CONCUNIT ug	/m^3										
DEPUNIT g/m	^2										

## REFERENCES

Briggs G. A. (1975) "Plume rise predictions". Lectures in air pollution and environmental impact analyses. American Meteorological Society, Boston

Environmental Protection Agency, 1977. Guidelines for Air Quality Maintenance Planning and Analysis, Volume 10 (Revised): Procedures for Evaluating Air Quality Impact of New Stationary Sources. EPA-450/4-77-001 (OAQPS Number 1.2- 029R), Research Triangle Park, NC.

Environmental Protection Agency, 1983. Regional Workshops on Air Quality Modeling: A Summary Report - Addendum. EPA-450/4-82-015. U.S. Environmental Protection Agency, Research Triangle Park, NC.

Environmental Protection Agency, 1987a. Guideline On Air Quality Models (Revised) and Supplement A. EPA-450/2-78-027R. U.S. Environmental Protection Agency, Research Triangle Park, NC. Environmental Protection Agency, 1987b. Analysis and Evaluation of Statistical Coastal Fumigation Models. EPA-450/4-87-002. U.S. Environmental Protection Agency, Research Triangle, Park, NC.

Egan B.A. (1975) "Turbulent diffusion in complex terrain". Lectures in air pollution and environmental impact analyses. American Meteorological Society, Boston

EPAV (1985) "Plume calculation procedure". Publication 210 EPA, Melbourne

EPAV (1986) "The AERMOD ver.9.0 Gaussian plume dispersion model" Publication 264 EPA, Melbourne

Emission Factor Documentation For AP-42, Section 1.3, Fuel Oil Combustion, Office of Air Quality Planning and Standards, U. S. Environmental Protection Agency, Research Triangle Park, NC, April 1993.

Hanna S. R. et al. (1982) "Handbook of atmospheric dispersion", Report DOE/TIC- 11223 (DE82002045) US Dept. of Energy.

Users guide for Industrial Source Complex (ISCST3) dispersion models , September 1995, U.S. ENVIRONMENTAL PROTECTION AGENCY , Office of Air Quality Planning and Standards, Emissions, Monitoring, and Analysis Division, Research Triangle Park, North Carolina 27711, September 1995

Pasquill F. (1976) "Atmospheric dispersion parameters in Gaussian plume modelling". Report EPA-600/4-76-030b

United States Environmental Protection Agency (US EPA) 1999. *Appendix W to Part 51, Guideline on air quality models.*

United States Environmental Protection Agency (US EPA), 1984. Interim procedures for evaluating air quality models. EPA 450/4-84-023.

**Greater Malé Waste to Energy Project**  
**Information on Greenhouse Gas Emission Calculations**  
**(Lifted from the project’s application to access JFJCM resources)**

**I. Specific data**

1. Description of the project and the subcomponent/s with the advanced low carbon technology

The Greater Male Environmental Improvement and Waste Management Project (the Project) will establish an integrated regional solid waste management system in Greater Male including collection, transfer, treatment using waste-to-energy (WtE) technology, disposal, recycling, dumpsite closure and remediation, public awareness in reduce-reuse-recycle (3R), and to strengthen institutional capacities for service delivery and environmental monitoring.

The project will be implemented in two phases. Phase 1, with an estimated cost of \$40 million, was approved by ADB in 2018, has the following components: (i) improved waste collection and transfer in Greater Male, (ii) improved dumpsite management and logistics on Thilafushi Island, (iii) improved island waste management systems, (iv) strengthened institutional capacity of WAMCO, (v) awareness campaign and behavior change, and (vi) project management, design, and supervision support.

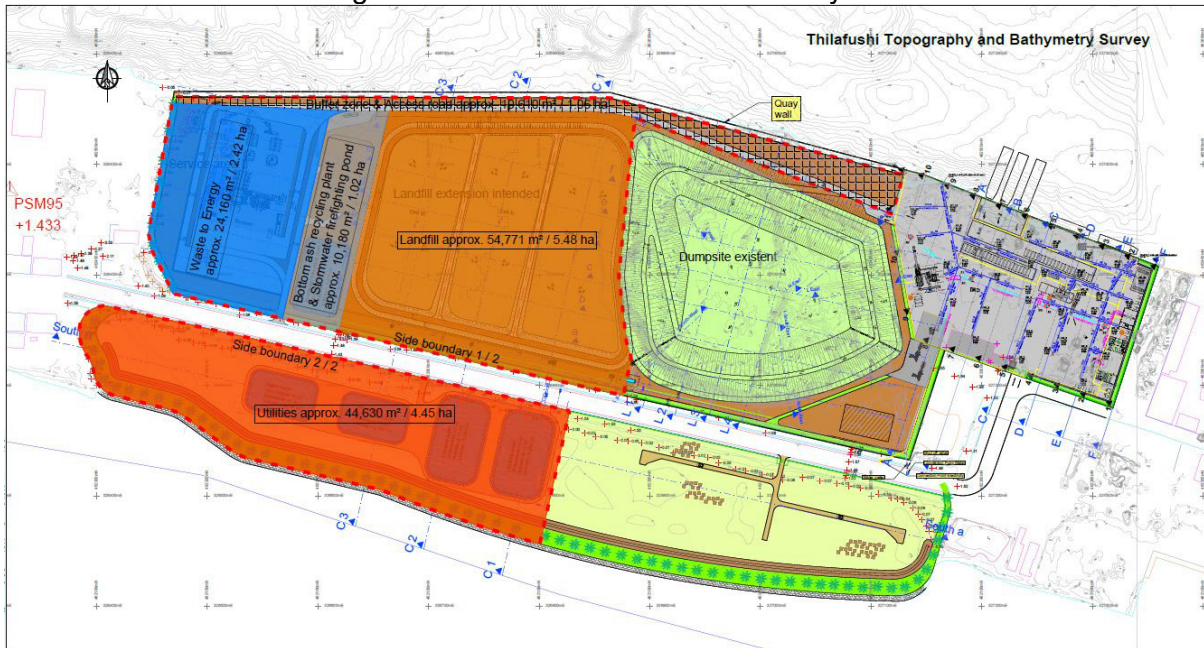
Phase 2 (Greater Male Waste to Energy Project) is planned for ADB approval in 2020, with total estimated cost of \$137.12 million (exclusive of contingency and financing charges). It includes the following components: (i) development of regional waste management facility with 500 tons/day WtE plant with up to 12 MW power generation, (ii) Thilafushi dumpsite rehabilitation and remediation, (iii) strengthened institutional capacity to monitor standards and performance of WtE, and (iv) improved public awareness

The development of a 500 tons/day WtE plant envisioned under the Greater Male Waste to Energy Project seeks funding from the JFJCM. The required land (approx. 15 ha) has been reclaimed by the Government to accommodate the plant and ancillary facilities on the island of Thilafushi, which is an industrial island 6 kilometers from the capital Male.

Figure 1: Location of Thilafushi



Figure 2: Thilafushi Provisional Site Layout



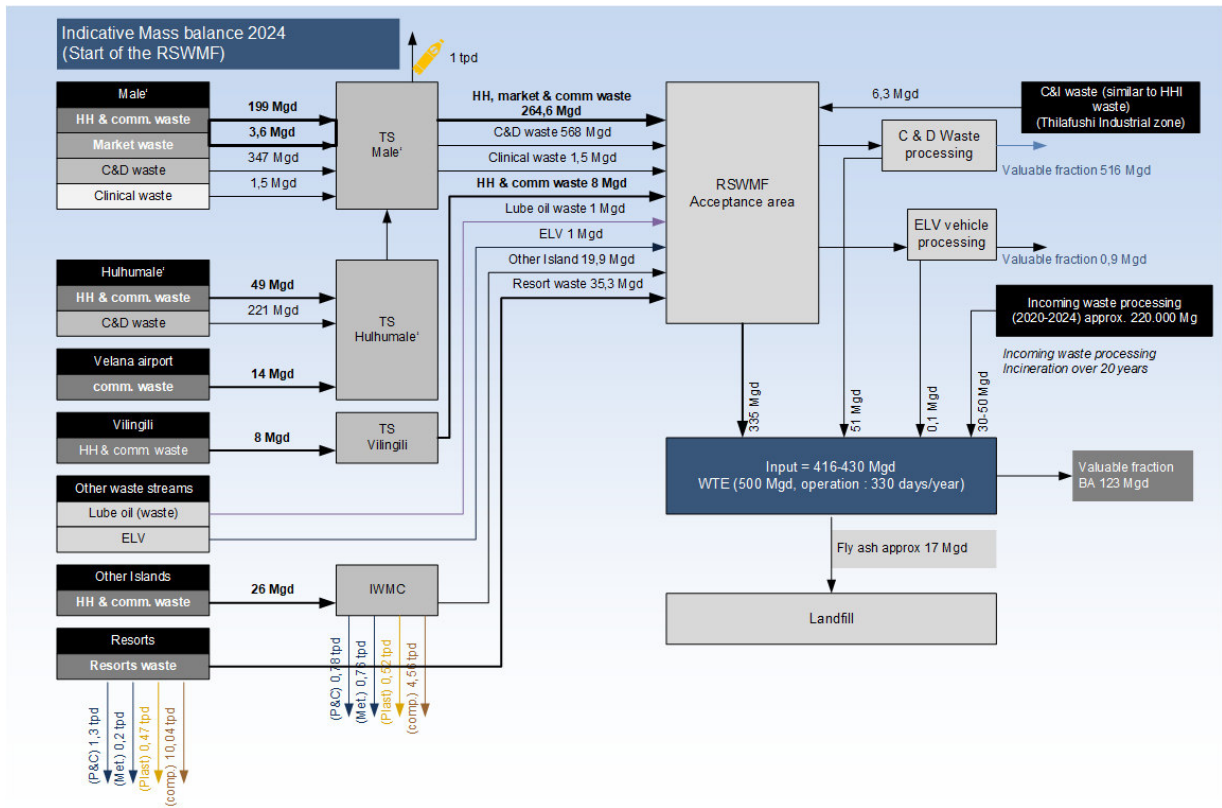
Government capacity to operate and maintain Phase 1 and Phase 2 (WtE) is supported by the Clean Authority of Tokyo (CAT), which is the public body in charge of coordinating solid waste management across Tokyo. The Project will reflect the lessons learned from the Tokyo model to effectively construct and operate the WtE system as well as to build trust for the WtE among the surrounding communities.

The project will provide integrated and sustainable solid waste management services in the Greater Malé region (Malé, Villingili & Hulhumalé) including the inhabited islands in atolls of Kaafu, Alifu Alifu, Alifu Dhaalu and Vaavu. The project area has a population of approximately 220,000 (51% of Maldives) which is spread over 35 islands and 73 tourist resorts. The population is expected to grow to 300,000 within the next five years due to the significant development of Hulhumale. Together with commercial and industrial entities, institutions and about 1 million tourists, in 2022 the residents will generate approximately 115,000 tons of Municipal Solid Waste (MSW) per year (around 315 tons per day) which is complemented by another 70,000 to 100,000 tons of construction and demolition waste (CDW). Around 10 to 15% of the CDW material is assumed to be flammable.

The 500 tons/day plant size considers projected waste growth in the Greater Male region up to 2038 and the incineration of waste bales during initial years of operations. The waste bales will be produced as temporary solid waste management solution on Thilafushi until the WtE will be commissioned. After 2039, it is planned to install additional treatment line to meet the growing waste management requirement. An indicative mass balance of the waste in the Greater Male area at the start of the WtE (2024) is summarized in Figure 3.

The latest waste audit carried out by the feasibility study consultants confirmed previous waste surveys and showed the following composition: food & kitchen waste 40%, green & garden waste 10%, other organic waste 10%, paper and cardboard 12%, plastic 10%, hazardous waste 1%, metal 4%, glass 3%, and other 10%. The net calorific value (NCV) of the waste is 7.5 MJ/kg.

Figure 3: Indicative Mass Balance of the waste in the Greater Male area (2024)



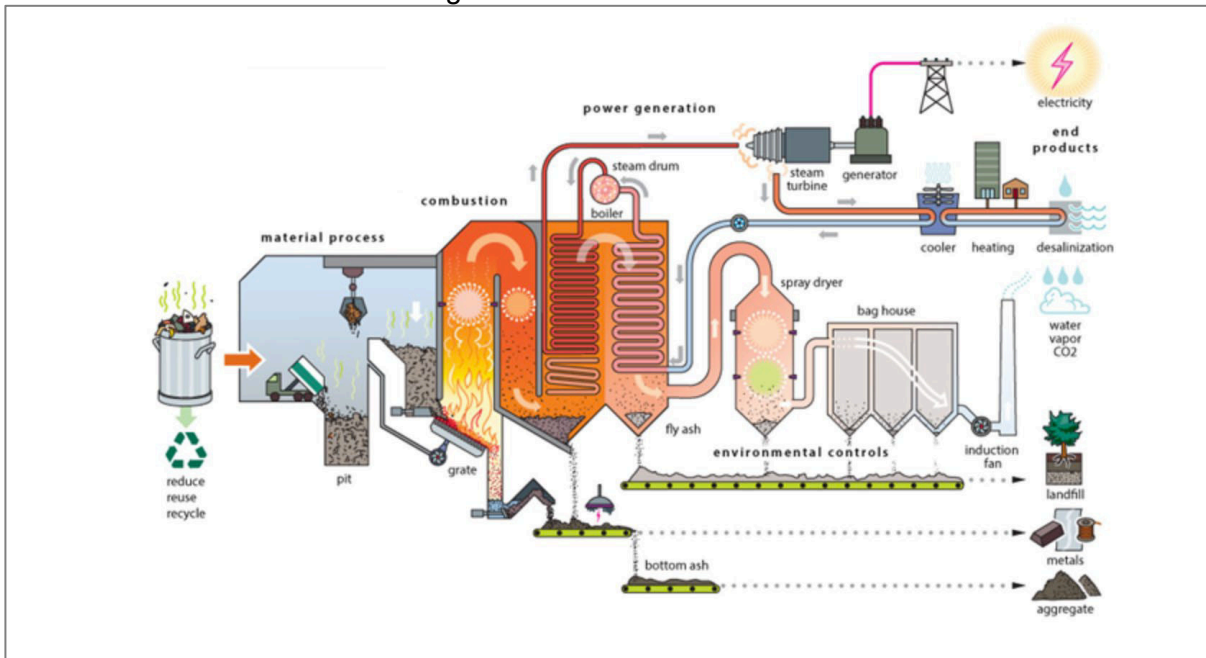
The project feasibility study selected a state-of-the-art WtE treatment based on a grate incineration due to land constraints on Thilafushi and sustainability considerations (best practicable environmental option). This WtE process is a well-known, reliable and robust disposal solution that can accommodate best the urgent needs for an environmental improvement of the waste management in the Maldives and that can cope with a broad variety of untreated waste.

The WtE subcomponents are:

- Waste reception and bunker/refuse pit
- Furnace including feeding hopper and pusher, moving grate and wet de-asher
- Boiler including superheaters and economizer
- Flue gas cleaning
- Extraction condensing type turbine and sea water cooled condenser
- Generator

The basic WtE process is shown in the following schematic diagram:

Figure 4: Basic WtE Process



The final design of the facility will be subject to the Design-Build-Operate (DBO) Contractor. A DBO procurement was chosen to minimize operational risks as such facility requires specialist know how that is not available in the Maldives.

All equipment the DBO contractor will install has to meet state-of-the art design and durability criteria such as 8,000 hours/year availability, high standards for protection of the corrosion prone boiler zones, redundancy of important equipment (waste feeding cranes, boiler feed water pumps, cooling water pumps etc.). The facility will be built as a two-train unit (250 tons/day x 2) thus allowing to accommodate any overhaul or revision without compromising the waste disposal entirely for the period of the overhaul.

Emission standards the flue gas treatment system has to meet will follow the latest European regulations while the capacity of local EPA will be strengthened to enable operational monitoring of the facility (partnership with the Clean Authority of Tokyo is addressing this). Furthermore, ADB will finance one year of monitoring of the facility through the design and construction supervision consultant that will be recruited to manage the entire design-build period.

The extraction condensing turbine will allow a versatile usage of the energy surplus the facility is generating either by producing electricity or both heat and electricity. The usage of surplus energy will depend on the local requirements such as production of ice flakes, water, generation of cooling energy etc.

The Government of the Maldives is planning to develop Thilafushi island as an industrial hub and plans are maturing to construct a bridge between the capital city of Male and the island that would facilitate to link the electricity grid on Thilafushi with the Male network. Once the network link is established, the power surplus of the WtE facility that is envisaged to be in the range between 6 and 9 MW (increase overtime) that can be fed into the network substituting diesel-based electricity generation that is the still predominant source of power generation in the Maldives. Given the current status of the waste treatment and the land scarcity of the Maldives, the WtE facility may be regarded as a measure that must not be delayed.



If the power link does not materialize via the bridge, the local grid operator STELCO may consider a submarine cable as the fuel savings due to the power fed into by the WtE plant are so significant that such submarine cable will provide a quick return on investment.

Calculating the CO<sub>2</sub>, the power output as per section 7 has been applied.

The outcomes from the implementing the subproject are (i) cleaner environment with no litter and smoke reaching Male or resorts, (ii) reduced leachate pollution into marine environment, and (iii) reduced emissions of greenhouse gasses (GHG). The impact is a healthy living environment in Greater Male.

## 2. Background of the project

Solid waste management in the project area is a top priority that has been acknowledged by the previous and the current government.

To date the majority of the waste generated within Zone 3 is dumped haphazardly on the island Thilafushi which is located close to the capital Malé. Waste from Malé, Hulhumale and Vilimale is delivered with landing crafts while resorts are using a vessel called “dhonis”. The island Thilafushi itself has been created using both MSW and CDW as reclamation material for more than 25 years now. Starting in 1992, land has been reclaimed from the lagoons to build up the artificial island.

Greater Male severely lacks an organized and environmentally sustainable solid waste management system. Waste management is operated by the recently established (2015) Waste Management Corporation Limited (WAMCO). Though the collection system is working under the conditions found in Male, there is no separate collection of construction, demolition, and hazardous wastes and no source separation of recyclables.

On small islands and low-cost resorts waste is dumped on beaches or in the deep ocean, and backyard burning or setting fires to open dump sites is a common practice on small islands with limited public awareness of 3R approaches.

Collected waste from Male, Hulhumale and Vilimale is transported on barges to the artificially created, industrially zoned Thilafushi Island located 6 kilometers from Male. The 30-year old 10-hectare open dumpsite managed by WAMCO has no leachate control systems and deliberate burning result in plumes of smoke and severe air pollution hazards to on-site workers, Male residents, and surrounding tourists generating frequent complaints. On-site equipment and site logistics are not sufficient or optimal to efficiently manage the growing volumes of incoming waste.

Reducing the GHG emissions is an urgent issue in Maldives as stated in the Maldives’ climate change mitigation target as described in its Nationally Determined Contribution (NDC) submitted to the United Nations Framework Convention Climate Change (UNFCCC) secretariat in April 2016. According to the NDC, Maldives has outlined a series of policies and measures that the country commits to implement up to 2030, in the energy, transportation and waste sectors. The expected mitigation impact of these policies and measures will be a 10% reduction in total national GHG emissions by 2030, compared to the projected emissions under a business as usual scenario. The 10% reduction expressed above could be increased up to 24% in a conditional manner, in the context of sustainable development, supported and enabled by availability of financial resources, technology transfer and capacity building.

## 3. Anticipated technology specification and usage

As mentioned above, the main objective of the Project is to implement a ready-to-use and state-of-the-art technology that is capable to process a wide range of untreated waste and that is

robust and reliable. The feasibility study consultant of the Government of the Maldives evaluated various technologies and compared them with respect to their technical, environmental, social and economic aspects.

- (1) Grate incineration: Incineration on a moving grate can offer manifold examples throughout the world (more than 2,400 treatment lines), can process a wide range of untreated waste, is known for its reliability and robustness and is applied by many waste management companies and public bodies worldwide. Because of these factors, the lower investment and operational expenditures, and particularly, because of the urgent need for a disposal solution, the grate incineration was ranked highest.
- (2) Gasification: The Government's consultant compared the currently available gasification technologies for MSW (fixed and fluidized bed, plasma). All of them require a tailored waste input and an advanced waste collection and pre-processing system prior to the thermal treatment. Given the current status of the waste management in Male and in Zone III, the requirements for waste pre-treatment, the lower energy output, the need for constant auxiliary fuel (fixed bed) and the higher CAPEX and OPEX for these technologies, they were not considered for the tendering.
- (3) Combination of incineration and anaerobic digestion of the biological waste material: The residues from the pre-processing and from the anaerobic digestion would then be incinerated. Though this option can be superior with respect to the energy output, the land required for the two facilities and the higher costs do not favor this option.

Given the evaluation, the grate incineration technology is selected. The track record of incineration with the moving grate technology shows the reliability and the range of wastes can be processed effectively.

#### 4. Technical specifications and evaluation and qualification criteria for procurement of the subcomponent

A design build operate (DBO) contract will be used as a procurement method, and the contractor will be awarded through international competitive bidding. Some of the main required specifications and qualifications are as follows.

##### (1) Technical Specifications

Main features of the state-of-the art WtE facility are robustness, reliability and durability of the electro-mechanical and civil components. As such, the following will be requested to the DBO contractor:

- Overall durability criteria for the civil and electro-mechanical part such as life time expectancy for the civil components of 50 years, turbine 40 years, moving grate 30 years, electrical components 30 years, fans/pumps 15 years, etc., all steel equipment and steel structure to be corrosion protected, track record for the grate technology applied;
- Minimum material thickness of erosion/abrasion/corrosion prone components (such as feeding hopper, pusher duct, boiler walls etc.)
- Redundancy of certain crucial components (waste cranes, boiler feed water and condensate pumps, hydraulic systems, cooling water pumps, etc.)

The basic specifications for the WtE and ancillary facilities are summarized in the table below. The final design and arrangement of the facilities within the project site will depend on the DBO Contractor. The Contractor will be required to adopt state-of-the-art incineration technology.

Table 1: Preliminary Design Parameters of the WtE and Ancillary Facilities

Parameter		Range/Data/Type	Remarks
WtE - Facility			
Capacity	t/y	167,000	
	t/hr	21	
No of trains		2	
NCV	kJ/kg	6,500 – 9,500	
Design NCV	kJ/kg	7,500	
Expected IBA amount	%	25	of input
Baled waste input	%	min. 10	of nominal mechanical capacity
Overload	%	10	of nominal thermal and mechanical capacity
Furnace		grate system 850°C, 2s	roller, forward or reciprocating
Boiler		natural circulation	horizontal or vertical boiler passes, cladding of corrosion prone boiler components
Turbine		extraction condensing	robustness is crucial, no. of turbines subject to DBO Contractor, extraction rate is yet to be defined, the final capacity of the turbine will depend on the Contractor's design
Re-cooling unit		sea water cooling	environmental sensitivity of coral reefs to be considered
APC system		Semi-Dry or dry system	final design subject to DBO Contractor meeting European emission standards is compulsory, minimising volume of residue
IBA processing		maturation, FE/NON-FE, crushing, screening	tradable volume subject to market
Residue landfill			
Total volume	m3	560,000	incl. base liner system or asphalt base and leachate collection system, for APC residues and non-marketable IBA (and other rejects)
No of cells		> 3	final design subject to DBO Contractor
Envisaged life time of landfill	years	> 15 years	subject to IBA recycling and marketing
Leachate treatment			
Treatment system		reverse osmosis	
Capacity	m3/d	120	expected throughput up to 55 m3/d (capacity reserve to cope with exceptional leachate volume due to weather conditions)
Brine disposal	m3/d	max. 14	via APC system of WtE

Also, the O&M shall be supervised on a daily basis by the Plant Manager who has more than 10 years of operation management experience at WtE facility. Engineering manager of primary technology provider and engineers of major equipment manufacturers shall be resident until performance of the WtE operation (8,000h/year).

## (2) Evaluation Criteria

The Bid shall comprise two envelopes submitted simultaneously, one containing the Technical Bid and the other the Price Bid, both envelopes enclosed together in an outer single envelope. In the Technical Bids evaluation process, the Employer will carry out a detailed technical evaluation to determine whether the technical aspects are in compliance with the Bidding Document. The evaluation criteria are under development, which will be used by the Employer to examine and compare the technical aspects of the Bids on the basis of the information supplied by the Bidders, taking into account the following:

- a) General aspects such as completeness of the proposals, the description of the EPC and project management, the health and security and environment management plan consideration, the preliminary operations and maintenance plan, their considerations towards disclosure of information to the public and etc;
- b) The bidders' capabilities to mobilise the required sub-contractors, the necessary equipment and personnel that need to be specified accordingly;
- c) The grate technology applied by the bidders must be a proven one, at least three years of successful operation;
- d) Some aspects such as thickness of wear prone components are specified which the bidders have to comply with;
- e) The potential energy output;
- f) All performance guarantees must be met, such as 8,000 hours availability (needs to be proven), operations within the stoker capacity diagram meeting the specified steam temperature and pressure and the emission standards at the stack and for the effluent of the leachate treatment and etc;
- g) Redundancy aspects, e.g. as for the cranes, for the boiler feed water supply, the cooling water supply etc.
- h) Design criteria to be taken into account, amongst others, the expandability of the facility (a third line) which needs to be considered in the design of certain components and elements of the facility;
- i) Compliance with standards;

The Bid that does not meet minimum and/or maximum acceptable standards of completeness, consistency, detail and performance guarantees, will be rejected for non-responsiveness;

Cost evaluation will be made on a life-cycle cost (LCC) basis, which means that both the initial cost, the operation and maintenance costs (variable and fixed costs) will be taken into account for evaluation. In addition to this, the incentive given to the contractor to generate electricity has to be taken into account. As the WtE facility will be producing a power surplus, for comparison reasons the overall energy sales which the Employer will accrue will be taken into consideration as well. In addition, if the bidder proposes to utilize the energy generated by the WtE to produce goods such as water as more reasonable and effective energy usage than the electricity for the grid, the revenue from the goods sale also can be taken into consideration when calculating the LCC. All costs and revenues during the O&M period will be discounted with an interest rate of 4% to get the net present value. The 4% were chosen to consider ADB's grant and both the concessional loan being provided by ADB and the more commercially oriented interest rates offered by AIIB and ISDB. Taking into account that an evaluation applying a low discount rate favors designs with high initial capex that can be operated at lower costs, which is in the interest of the Government of Maldives, the 4% are deemed reasonable.

$$\text{Life Cycle Cost} = \text{Costs for the Design-Build} + \text{NPV}(\text{fixed O\&M fee related the technology and technology provider}) + \text{NPV}(\text{variable O\&M fee related the technology and technology provider}) + (\text{NPV}(\text{electricity incentive}) + \text{NPV}(\text{asset replacement costs}) - \text{NPV}(\text{electricity sales}))$$

### (3) Qualification Criteria

A pre-qualification process was conducted from May to August 2019, and shortlisted bidders will be invited to participate in the bidding process. The qualification of the bidders will be assessed with the following criteria (excerpt):

- (a) Participation in at least two WtE DBO contracts (or similar long term BOT or PPP contracts) where design-build has been successfully or substantially completed within the last 10 years and that is similar to the proposed facilities, where the value of the Applicant's participation exceeds 75% of the total value of the reference contract (For JV, all partners combined must meet requirement as follows: 1) either one partner must meet requirement, or 2) any two partners must each demonstrate one successfully or substantially completed contract of similar size and nature). The reference contracts shall comply with the following criteria:
  - o The minimum facility throughput capacity for each contract shall be 250 tons/day;
  - o The operating and maintenance period specified in the contract shall be ten years or more.
- (b) Minimum average annual turnover of not less than \$64 million within the last 3 years.
- (c) Lead/managing partner for a Design-Build-Operate contract (or similar long term BOT/PPP contract) for waste to energy plant of at least 250 tons/day capacity, where the design-build has been successfully or substantially completed within the last ten years (For JV, one partner must meet requirements).
- (d) O&M of at least one waste to energy plants of at least 250 tons/day capacity (For JV, one partner must meet requirements). Each reference contract shall comply with the following criteria:
  - o The O&M component of the contract is either ongoing or was completed no more than five years ago;
  - o If the contract is ongoing, the contract has been running for two years or more;
  - o The O&M contract specifies an operating and maintenance period of ten years or more;
  - o The subject WtE facility has been operating successfully since commencement of the O&M contract, meeting the specified emission requirements.

The prime technology provider, including its consolidated subsidiaries, must have the experience of having completed at least three contracts of nature, size and complexity similar to the proposed (sub-)contract of WtE for municipal solid waste including design, engineering, procurement, manufacturing, transportation, installation and testing/commissioning. Each reference contract shall be for a plant with a capacity of at least 250 tons per day and under operation for more than 10 years. The prime technology provider shall also have one reference contracts outside the (sub-)contractor's home country. The prime technology provider shall have an experience of providing flue gas treatment process that complies with prescribed environmental standards of reference contract.

The Bid evaluation will be conducted by the Employer (Ministry of Environment, Maldives) and substantially supported by a team of international consultants including a DBO specialist, WtE mechanical engineer, a WtE O&M specialist and a WtE financial evaluation specialist.

5. If the specific provider and technology is identified, the spec of the technology

No specific provider and technology are identified.

6. Estimated reduction amount of CO<sub>2</sub> emission from energy sources by the advanced low carbon technology, energy efficiency improvement and/or renewable energy capacity installed and total reduction amount of GHG emission.

In accordance with the proposed outline of the methodology shown below in section II.9, the estimated emissions in tons of carbon dioxide equivalent are 808,345 tCO<sub>2</sub>e for 20 years as shown in Table 2 below. The process for its calculation can be found in the Annex IV: JCM

monitoring plan sheet, which is drafted based on the JCM\_MM\_AM001\_ver01.0.  
[https://www.jcm.go.jp/mm-jp/methodologies/75/monitoring\\_spreadsheet\\_file](https://www.jcm.go.jp/mm-jp/methodologies/75/monitoring_spreadsheet_file)

Table 2. Estimated Emission Reductions from the WtE JCM Subcomponent

Year	Reference emissions		Project emissions		Emission reductions		Accumulated GHG ERs	
	GHG total	CO2 only	GHG total	CO2 only	GHG total	CO2 only	GHG total	CO2 only
Unit	tCO2e	tCO2	tCO2e	tCO2	tCO2e	tCO2	tCO2e	tCO2
2025	36,380.2	36,380.2	38,941.4	36,428.2	-2,561.2	-48.0	-2,561.2	-48.0
2026	61,931.4	54,930.2	43,075.9	40,276.0	18,855.5	14,654.2	16,294.3	14,606.2
2027	69,230.3	56,260.8	43,959.7	41,098.5	25,270.6	15,162.3	41,564.9	29,768.5
2028	75,150.0	57,518.6	44,799.4	41,880.0	30,350.6	15,638.6	71,915.5	45,407.1
2029	78,794.1	57,414.2	44,742.2	41,826.8	34,051.9	15,587.4	105,967.4	60,994.5
2030	81,741.5	57,425.0	44,757.8	41,841.3	36,983.7	15,583.7	142,951.1	76,578.2
2031	84,114.3	57,426.5	44,764.5	41,847.5	39,349.8	15,579.0	182,300.9	92,157.2
2032	86,078.3	57,430.1	44,768.9	41,851.6	41,309.4	15,578.5	223,610.3	107,735.7
2033	87,740.1	57,435.1	44,770.5	41,853.1	42,969.6	15,582.0	266,579.9	123,317.7
2034	89,173.8	57,440.9	44,769.2	41,851.9	44,404.6	15,589.0	310,984.5	138,906.7
2035	90,432.4	57,448.1	44,764.3	41,847.3	45,668.1	15,600.8	356,652.6	154,507.5
2036	91,552.3	57,456.0	44,755.9	41,839.5	46,796.4	15,616.5	403,449.0	170,124.0
2037	92,560.9	57,465.4	44,743.7	41,828.2	47,817.2	15,637.2	451,266.2	185,761.2
2038	93,477.5	57,476.2	44,727.6	41,813.2	48,749.9	15,663.0	500,016.1	201,424.2
2039	94,306.5	57,478.3	44,581.7	41,677.4	49,724.8	15,800.9	549,740.9	217,225.1
2040	95,071.9	57,509.3	44,456.4	41,560.8	50,615.5	15,948.5	600,356.4	233,173.6
2041	95,763.1	57,538.8	44,331.6	41,444.6	51,431.5	16,094.2	651,787.9	249,267.8
2042	96,392.8	57,569.0	44,207.0	41,328.7	52,185.8	16,240.3	703,973.7	265,508.1
**2043	96,392.8	57,569.0	44,207.0	41,328.7	52,185.8	16,240.3	756,159.5	281,748.4
**2044	96,392.8	57,569.0	44,207.0	41,328.7	52,185.8	16,240.3	808,345.3	297,988.7
Total	1,692,677.0	1,124,740.7	884,331.7	826,752.0	808,345	297,989		

\*\* The values of 2042 are used for 2043 and 2044 because the JCM\_MM\_AM\_001 can only calculate the values for 18 years. This is considered conservative as the actual values (emission reductions) in 2043 and 2044 are estimated higher than in 2042.

For the scenario analysis to calculate the emission reductions above, the following data on the waste incinerated and net energy outputs were assumed.

Table 3: Waste to be incinerated and net energy output (incl. baled waste)

	Waste Incinerated (t)	Net Energy Output (MWh)
2025	139,400	50,528
2026	155,300	76,292
2027	158,699	78,140
2028	161,928	79,887
2029	161,708	79,742
2030	161,768	79,757
2031	161,794	79,759
2032	161,811	79,764
2033	161,817	79,771
2034	161,812	79,779
2035	161,793	79,789

2036	161,761	79,800
2037	161,714	79,813
2038	161,652	79,828
2039	161,091	79,831
2040	160,609	79,874
2041	160,129	79,915
2042	159,650	79,957
*2043	159,172	79,998
*2044	158,696	80,038

\*The values for 2043 and 2044 are not used for the calculation of the emission reductions in the methodologies because the JCM\_MM\_AM\_001 can only calculate the values for 18 years.

As stated in the section II.1 above, the proposed 500 tons/day plant can deal with the waste growth in the Greater Male region up to 2038. While it is planned to install additional treatment line to meet the growing waste management requirement in 2039, the above data does not include the additional line for the purpose of fairly calculating the energy output and GHG emission reductions materialized by the JFJCM grant.

The actual emission reductions occur from 2026 while the operation of the plant starts from 2025. This is because, for the first year (2025), the annual GHG emission reductions are expected to be negative (emissions increase) due to small contribution of methane emission reductions and low energy surplus fed into the grid.

7. Co-benefit of the environment and region

(Describe the reduction of environmental pollution, including air or water pollution, solid waste treatment or conservation of natural resources, and/or (b) other social economic benefits, including increased job creation opportunities and better access to basic infrastructures)

The Project will bring significant environmental, social and economic co-benefits.

(a) Reduction of the MSW directly disposed in the landfill site will result in

- a. improved health of the residents by minimising the odour and smoke from spontaneous combustion;
- b. improved marine ecosystem by minimising the waste dumping to the ocean;
- c. expanded lifetime of the landfill site (minimised waste volume to be delivered to the landfill).

(b) Reduction of diesel oil use will result in

- a. improved energy security and trade balance of the government as the Maldives heavily depends on diesel for power generation, which is entirely imported;

8. The applied JCM MRV methodology (If not existing, the rough proposal of JCM methodology)

The methodology to be applied for the Project will be considered based on the approved methodology: JCM\_MM\_AM001\_ver01.0 (Power generation and avoidance of landfill gas emissions through combustion of municipal solid waste (MSW)).

(1) Title of the methodology:

Power generation and avoidance of landfill gas emissions through combustion of municipal solid waste (MSW)

(2) Summary of the Methodology

(i) GHG emission reduction measures:

- (a) Installation of MSW incinerators avoids emissions of methane associated with disposed organic waste in a solid waste disposal site (SWDS);
- (b) Electricity generated by the project facility displaces electricity from a grid or captive power generator which is generated using fossil fuels resulting in GHG emission reductions.

(ii) Reference emissions: Reference emissions are calculated as a sum of the following emissions:

- (a) CH<sub>4</sub> emissions from SWDS: Calculated from the amount of MSW and fraction of each waste type incinerated in the incinerator using the first order decay (FOD) model; and
- (b) CO<sub>2</sub> emissions from a grid or captive power generator: Electricity fed into the grid by the project facility multiplied by the emission factor of displaced electricity.

(iii) Project emissions: Project emissions are calculated as a sum of the following emissions:

- (a) CO<sub>2</sub> emissions from combustion of fossil carbon contained in MSW: The amount of MSW multiplied by the fraction of fossil carbon content and the conversion factor of carbon;
- (b) N<sub>2</sub>O emissions from combustion of waste: The amount of MSW multiplied by the N<sub>2</sub>O emission factor associated with incineration;
- (c) CO<sub>2</sub> emissions from electricity used to operate the project facility: Electricity used to operate the project facility multiplied by the emission factor of electricity; and
- (d) CO<sub>2</sub> emissions from auxiliary fossil fuel consumption associated with incineration: The amount of fossil fuel consumption associated with incineration multiplied by the emission factor of the fossil fuel.

(iv) Monitoring parameters:

- (a) Quantity of MSW fed into incinerator (wet basis);
- (b) Quantity of electricity generated by the project facility;
- (c) Quantity of electricity consumed by the project facility; and
- (d) Quantity of auxiliary fossil fuel consumed.

(3) Eligibility criteria

This methodology is applicable to projects that satisfy all of the following criteria.



Criterion 1	The project newly installs an incinerator, waste heat recovery boiler, exhaust gas treatment equipment and turbine generator.
Criterion 2	The project incinerates municipal solid waste (MSW) which has been disposed at a SWDS where the generated landfill gas is not recovered, and generates electricity from steam produced in waste heat recovery boiler.
Criterion 3	There is a plan to operate the project facility for more than 5 years.

#### (4) Reference scenario

A project which applies this methodology incinerates MSW and generates electricity. In Maldives, MSW is usually disposed in open dump sites without recovering landfill gas. Although some initiatives exist to treat waste with alternative methods such as incinerating MSW, the cost of alternative treatment of waste hampers its installation. Therefore, without the financial assistance the alternative waste treatment facility would not be bankable. As a result, BaU for MSW treatment is open dumping and setting fire to the waste and BaU emissions are CH<sub>4</sub> emissions from decomposition of MSW at a SWDS and CO<sub>2</sub> emissions from fossil fuels combusted to generate electricity which would be displaced by the project. CH<sub>4</sub> emissions from decomposition of MSW at a SWDS are calculated based on a first order decay (FOD) model.

To assure net emission reductions, the model correction factor which accounts for uncertainty of the model to calculate emissions from decomposition of MSW is set conservatively. Therefore, the reference emissions are a summation of conservative CH<sub>4</sub> emissions from decomposition of MSW at a SWDS and CO<sub>2</sub> emissions from fossil fuels combusted to generate electricity which would be displaced by the project.

#### (5) Calculation formulas

(i) Calculation of reference emissions:

$$RE_p = RE_{CH_4,p} + RE_{elec,p}$$

Where:

RE<sub>p</sub> = Reference emissions during the period *p* [tCO<sub>2</sub>e/*p*]

RE<sub>CH<sub>4</sub>,p</sub> = Reference emissions from decomposition of MSW at a SWDS during the period *p* [tCO<sub>2</sub>e/*p*]

RE<sub>elec,p</sub> = Reference emissions from electricity generation during the period *p* [tCO<sub>2</sub>e/*p*]

Reference emissions from decomposition of MSW at a SWDS during the period *p* (RE<sub>CH<sub>4</sub>,p</sub>) is accounted only from the next calendar year after its disposal at a SWDS (or incineration) due to delay in generation of CH<sub>4</sub> from the time of disposal at a SWDS.

$$RE_{CH_4,p} = \sum_{y=p\_start}^{p\_end} \left[ \varphi \times (1 - f) \times GWP_{CH_4} \times (1 - OX) \times \frac{16}{12} \times F \times DOC_f \times MCF \right. \\ \left. \times \sum_{i=1}^{y-1} \sum_j \{W_i \times P_j \times DOC_j \times e^{-k_j(y-1-i)} \times (1 - e^{-k_j})\} \right]$$

Where:

- $RE_{CH_4,p}$  = Reference emissions from decomposition of MSW at a SWDS during the period  $p$  [tCO<sub>2</sub>e/p]
- $y$  = The N<sup>th</sup> year from the first disposal (or incineration), extending from the first year of the period  $p$  ( $y=p\_start$ ) to the last year of the period  $p$  ( $y=p\_end$ ). If  $y$  is equal to 1, methane generation cannot be accounted.
- $p\_start$  = The N<sup>th</sup> year from the first disposal (or incineration), which is the first year of the period  $p$
- $p\_end$  = The N<sup>th</sup> year from the first disposal (or incineration), which is the last year of the period  $p$
- $\varphi$  = Model correction factor to account for model uncertainties
- $f$  = Fraction of methane captured at a SWDS and flared, combusted or used in another manner that prevents the emissions of methane to the atmosphere
- $GWP_{CH_4}$  = Global Warming Potential of methane [tCO<sub>2</sub>e/tCH<sub>4</sub>]
- $OX$  = Oxidation factor (reflecting the amount of methane from a SWDS that is oxidized in the soil or other material covering the waste)
- $\frac{16}{12}$  = Conversion factor [tCH<sub>4</sub>/tC]
- $F$  = Fraction of methane in the SWDS gas [volume fraction]
- $DOC_f$  = Fraction of degradable organic carbon (DOC) that decomposes under the specific conditions occurring in a SWDS [weight fraction]
- $MCF$  = Methane correction factor
- $i$  = The N<sup>th</sup> year from the first disposal (or incineration), extending from the first year in the time period in which MSW is disposed at a SWDS ( $i = 1$ ) to year  $y$  ( $i = y$ )
- $W_i$  = Quantity of MSW fed into incinerator in the year  $i$  (wet basis) [t]
- $P_j$  = Fraction of the waste type  $j$  [weight fraction]
- $DOC_j$  = Fraction of degradable organic carbon in the waste type  $j$  [weight fraction]
- $k_j$  = Decay rate for the waste type  $j$  [1/yr]
- $j$  = Type of waste

$$RE_{elec,p} = EG_{elec,p} \times EF_{elec}$$

Where:

- $RE_{elec,p}$  = Reference emissions from electricity generation during the period  $p$  [tCO<sub>2</sub>e/p]
- $EG_{elec,p}$  = Quantity of electricity generated by the project facility during the period  $p$  [MWh/p]
- $EF_{elec}$  = Emission factor for electricity generation [tCO<sub>2</sub>e/MWh]

(ii) Calculation of project emissions

$$PE_p = PE_{COM\_CO_2,p} + PE_{COM\_N_2O,p} + PE_{EC,p} + PE_{FC,p}$$

Where:

- $PE_p$  = Project emissions during the period  $p$  [tCO<sub>2</sub>e/p]

- $PE_{COM\_CO2,p}$  = Project emissions of CO<sub>2</sub> from combustion of fossil carbon contained in waste associated with incineration during the period  $p$  [tCO<sub>2</sub>e/p]
- $PE_{COM\_N2O,p}$  = Project emissions of N<sub>2</sub>O from combustion of waste associated with incineration during the period  $p$  [tCO<sub>2</sub>e/p]
- $PE_{EC,p}$  = Project emissions from electricity consumption by the project facility during the period  $p$  [tCO<sub>2</sub>e/p]
- $PE_{FC,p}$  = Project emissions from auxiliary fossil fuel consumption associated with incineration during the period  $p$  [tCO<sub>2</sub>e/p]

$$PE_{COM\_CO2,p} = EFF_{COM} \times \frac{44}{12} \times \sum_j \left( \sum_{i=p\_start}^{p\_end} W_i \times P_j \times \frac{DC}{100} \times FCC_j \times FFC_j \right)$$

Where:

- $PE_{COM\_CO2,p}$  = Project emissions of CO<sub>2</sub> from combustion of fossil carbon contained in waste associated with incineration during the period  $p$  [tCO<sub>2</sub>e/p]
- $EFF_{COM}$  = Combustion efficiency of incinerator [fraction]
- $\frac{44}{12}$  = Conversion factor [tCO<sub>2</sub>/tC]
- $i$  = The N<sup>th</sup> year from the first incineration
- $p\_start$  = The N<sup>th</sup> year from the first incineration, which is the first year of the period  $p$
- $p\_end$  = The N<sup>th</sup> year from the first incineration, which is the last year of the period  $p$
- $W_i$  = Quantity of MSW fed into incinerator in the year  $i$  (wet basis) [t]
- $P_j$  = Fraction of the waste type  $j$  [weight fraction]
- $DC$  = Dry matter content of MSW [%]
- $FCC_j$  = Fraction of total carbon content in waste type  $j$  [tC/t]
- $FFC_j$  = Fraction of fossil carbon in total carbon content of waste type  $j$  [weight fraction]
- $j$  = Type of waste

$$PE_{COM\_N2O,p} = \sum_{i=p\_start}^{p\_end} W_i \times EF_{N2O} \times GWP_{N2O}$$

Where:

- $PE_{COM\_N2O,p}$  = Project emissions of N<sub>2</sub>O from combustion of waste associated with incineration during the period  $p$  [tCO<sub>2</sub>e/p]
- $i$  = The N<sup>th</sup> year from the first incineration
- $p\_start$  = The N<sup>th</sup> year from the first incineration, which is the first year of the period  $p$
- $p\_end$  = The N<sup>th</sup> year from the first incineration, which is the last year of the period  $p$
- $W_i$  = Quantity of MSW fed into incinerator in the year  $i$  (wet basis) [t]
- $EF_{N2O}$  = Emission factor for N<sub>2</sub>O associated with incineration [tN<sub>2</sub>O/t waste]
- $GWP_{N2O}$  = Global Warming Potential of nitrous oxide [tCO<sub>2</sub>e/tN<sub>2</sub>O]

$$PE_{EC,p} = EC_p \times EF_{elec}$$

Where:

- $PE_{EC,p}$  = Project emissions from electricity consumption by the project facility during the period  $p$  [tCO<sub>2</sub>e/p]
- $EC_p$  = Quantity of electricity consumed by the project facility during the period  $p$  [MWh/p]
- $EF_{elec}$  = Emission factor for electricity generation [tCO<sub>2</sub>e/MWh]

$$PE_{FC,p} = \sum_{\text{fuel}} (FC_{\text{fuel},p} \times NCV_{\text{fuel}} \times EF_{CO_2,\text{fuel}})$$

Where:

- $PE_{FC,p}$  = Project emissions from auxiliary fossil fuel consumption associated with incineration during the period  $p$  [tCO<sub>2</sub>e/p]
- $FC_{\text{fuel},p}$  = Quantity of auxiliary fossil fuel consumed during the period  $p$  [kL or m<sup>3</sup>/p]
- $NCV_{\text{fuel}}$  = Net calorific value of fuel [GJ/kL or m<sup>3</sup>]
- $EF_{CO_2,\text{fuel}}$  = CO<sub>2</sub> emission factor of fuel [tCO<sub>2</sub>/GJ]
- fuel = Type of fuel

(iii) Calculation of emissions reductions

$$ER_p = RE_p - PE_p$$

Where:

- $ER_p$  = Emission reductions during the period  $p$  [tCO<sub>2</sub>e/p]
- $RE_p$  = Reference emissions during the period  $p$  [tCO<sub>2</sub>e/p]
- $PE_p$  = Project emissions during the period  $p$  [tCO<sub>2</sub>e/p]

Details of the data and parameters fixed ex ante and to be monitored or calculated ex post, with the assumption used for calculating emission reductions in the section 7, are summarized in the Annex III.

# **Minutes of Stakeholders Consultations**



**Minutes of the  
Stakeholder meeting for development of the EIA for the Regional Waste  
Management Facility at Zone 3 in Thilafushi**

Venue: Auditorium, Ministry of Environment

Date: 20<sup>th</sup> September 2018

Time: 9:00

The stakeholders for the establishment of the Regional Waste Management Facility at Thilafushi was held at Ministry of Environment and Energy on 20<sup>th</sup> September 2018. The meeting was organized by Ministry of Environment for a request by Water Solutions Pvt Ltd as the EIA consultant for the project.

The meeting was initiated by an introduction of the project by a brief introduction to the project by the project management team at the Ministry of Environment. They highlighted that ADB is financing the project in association with International Partners. Then Consultant for the project provided a detail outline of the project and the EIA Consultant provided the details of the EIA work that has been carried out as part of the project.

Mr. Kasdarli Chakir, Engineer, KOCKS CONSULT GMBH, provided a very detail outline of the proposed regional waste management facility development project for Zone III at Thilfushi. The detail account of the project included the proposed harbour rehabilitation component of the project to improve the waste acceptance area at Thilfushi, existing dumpsite rehabilitation component and the main Waste to Energy Facility component that is referred as the Regional Waste Management Facility for Zone III at Thilhafushi.

Mr. Ahmed Jameel, EIA Consultant at Water Solutions provided an outline of the work that had been carried out as part of the EIA for the project. He highlighted that Water Solutions is undertaking a “hot water dispersion modelling work” to study the impacts of the hot water that would be discharged into the marine environment from the waste to energy plant. A dispersion modelling was done to study the stack height and the impacts of emission from the stack on the surrounding areas of Thilafushi. A geophysical study was carry out to determine the thickness of the waste that has been buried out at the landfill at Thilafushi. The consultant outlined that groundwater and marine water would be studied to establish the baseline at the proposed project site.

Aima, Engineer from GMIZ informed, GMIZ has plans to construct a new road from the periphery (southern side) of the newly reclaimed area at Thilfushi. This is to facilitate the ease of transportation between the eastern and western side of the halves of the island as the existing road that has been build is not expected to meet traffic demand that is expected in the future and establishment of the industries at Thilhafushi. However, Aiman, noted that it is just an idea that they are exploring and it has not developed into an advance stage of planning.

In reply, Chakir mentioned that the boundary of the reclaimed land is not confirmed and therefore it is difficult to see if land could be allocated for a new road. Chakir also mentioned that the proposition for this new roads shall be cleared before the procurement or any further steps. Furthermore, Chakir mentioned that ADB suggests a buffer zone for better coastal management.



Mr. Zameel from PMU suggested to have a policy level meeting to make final decision about the new road.

Mr. Ahmed Afrah Ismail EPA raised the issue of ownership of the energy that would be produced from the WTE (Waste to Energy Facility) and other valuable by products.

Chakir replied that the ownership and responsibility of the products from WTE has not been decided. This includes energy from waste to energy, metals and bottom ash. Excess energy will be converted into hot water and discharge to the sea. A business model shall be made to determine a percentage profit for the operators.

EPA also asked if it would be feasible for the operators to run without selling the energy produced.

Chakir replied that WAMCO will establish a tariff system. Operators will charge a gate fee as well. Taxpayers will have to subsidize the burning of waste.

In reply to EPA's question regarding the air pollution control for the system, Chakir provided details of the project stating that it would be the contractor's responsibility and obligation. There will live monitoring and external controls to ensure that air pollution from the stack is within the acceptable range. EPA should also have access to this data and shall be able to run individual assessments. The facility owner is MEE and as EPA is under MEE, EPA has a right to monitor and conduct regular monitoring. Operator will have to maintain emissions under international standards and currently there are no local air quality standards.

Ms Shaahina Ali from Parley highlighted that the proposed regional waste management facility is based on incineration. Sorting and segregation is not in the part of the entire waste management system, especially as this has started from collection, transfer and incineration. EPA also mentioned that they plan to start segregation of waste, however it discourage the citizens to segregate even in 15 years if the government plans to incinerate all the waste. They suggested that government should encourage waste reduction and sorting, either from a centralized or a decentralized system.

WAMCO replied saying that a sorting facility cannot be accommodated in the Male' transfer station and there will be a civic amenity facility at Hulhumale' where people can bring in their sorted waste.

Concerns were raised if all waste materials will be bailed if the WTE is down, to which Chakir replied that there is bunker with a capacity of 6 days. There is also a second line of at WTE, so there will not be complete shutdown of the system. He also added that a third line is foreseen in 15 years as the waste generation is expected to increase to 700 tonnes per day.

Moosa Haneef from HPA mentioned that the healthcare waste is not pretreated and if the waste management system can incinerate this waste at the waste management facility. EPA also inquired whether the proposed facility could incinerate hazardous waste. It was noted from the consultant that waste to energy plant can manage small quantity of the waste. However batteries should not be incinerated. Chakir replied that the 5 small incinerators were specially designed for healthcare waste.

WAMCO – can incinerator take large aluminum? Yes, there will be magnets and sieving.



EPA questioned when the open burning will stop in Thliafushi, to which the project manager replied that it will be done after obtaining the required machinery such as excavators and bulldozers.

Parley for the Oceans asked if the Male' Waste Transfer facility is under this project to which Chakir replied that it is, and so is Villingili and Hulhumale' Transfer Station. Parley inquired whether the facility could incinerate used tires. The consultant noted that the tires are high calorific value item that can be incinerated.

EPA asked of the capacity of the incinerator was designed for and if the design foresees a decrease in waste generation. The concept of the project does not seem to focus on waste reduction but the opposite. Chakir mentioned that this was the best feasible option for management waste that is generated in Zone III. Waste generation of 400tonnes per day without CnD waste is expected for 2022. Waste is also expected to increase from the tourism industry and after the airport development project is completed. There needs to be policy level changes to incorporate and implement sorting and waste reduction, such as less packaging. The proposed method is a safe treatment that technical and realistic.

GMIZ question about the kind of traffic that is expected after the project. Chakir replied that not much increase is expected. For the island connections, 2 to 3 vessels are expected to increase. Sometimes resorts bring in waste from the islands.

EPA noted that incineration should be the last option to consider after sorting, composting and pyrolysis. WS and KOCKS suggested sorting with colored plastic bags but was not considered due to management issues. Germany has been doing this and they have 70% sorting after 30 years of awareness.

Currently there is no hazard waste management but there should be.





**Attendance**

Following officials attended the stakeholder meeting that was held at Ministry of Environment and Energy

<b>Name</b>	<b>Title</b>	<b>Organization / Address</b>	<b>Contact</b>
Mohamed Hamdhaan	Assistant Project Coordinator	Ministry of Environment and Energy	7681878
Ibrahim Zameel	Project Manager	Ministry of Environment and Energy	7794959
Aminath Maleeha Sollih	Procurement Specialist	Ministry of Environment and Energy	7931645
nafha.aujaz	Environment Analyst	Ministry of Housing and Infrastructure	3004110
Aishath Bariya	Engineer	Ministry of Housing and Infrastructure	3004110
Moosa Haneef	SDHPO	Health Protection Agency	7423180
Ismail Ubaidh	CS Manager	WAMCO	7931008
Ahmed Shafiu	BD & Marketing	WAMCO	7698899
Aminath Nazra	Project Officer	Save the Beach	7620044
Aminath Mohamed	Environment Analyst	Environment Protection Agency	7504494
Shaahina Ali	Executive Director	Parley for the Oceans	7771341
Ahmed Afrah Ismail	Engineer	Environment Protection Agency	9690600
Aiman	Engineer	Greater Male' Industrial Zone	7236734
Ahmed Jameel	Environment Consultant	Water Solution	7785379
Nashfa Nashidh	Junior Environmental Consultant	Water Solution	9533094
Kasdarli Chakir	Engineer	KOCKS CONSULT GMBH	+49 261 1302 112



**Photos from the Stakeholder Meeting**





C



**Ministry of Environment**

Male', Republic of Maldives.

ދިވެހިސަރުކާރުގެ ގެޒެޓް  
ކޮލިފިކޭޝަން ބޯލަންދެން

## Minutes of the Meeting

**Meeting Title:** GMEIWP ADB Mission Meetings- Stakeholder Consultation 1

**Date:** 5<sup>th</sup> August 2019

**Location:** Ministry of Environment

### *Participants:*

- Ministry of Environment (ME)
  - Mohamed Asif- Social and Environmental Safeguard Specialist.
  - Hana Farook- Assistant Project Coordinator
- Asian Development Bank (ADB)
  - Luca Di Mario- Urban Development Specialist/Project technical Leader
  - Ninnete Pajarillagu- Environment Specialist
  - Emma Marsnene- Senior Environmental Specialist
  - Miguel Diangan Jr- Environment Safeguards Consultant
- Asian Infrastructure Investment Bank (AIIB)
  - Irish Fe Aguilar- Social Development Specialist
- Water Solutions
  - Ahmed Jameel- Senior Consultant
  - Mohamed Umar- Junior Environmental Consultant.
- Others
  - Chathuranga- Environment & Sustainability Manager, Crossroads
  - Pradeep Kumar- Chief Engineer, Adaaran
  - Mohamed Faruhad, Assistant Chief Engineer, Vellasar
  - Sidath Anuruddha Paskuwal Handi, Chief Engineer, Vellasar
  - Mohamed Sinan, Environmental Officer, Ministry of Tourism

## C



### Ministry of Environment

Male', Republic of Maldives.

ދިވެހިސަރުކާރުގެ ގެޒެޓް ގައި ބަޔާންކުރި ގޮތުގައި  
މިއަހަރުގެ ފެބްރުއަރީ 2023 ވަނަ އަދަދުގައި

- Mariyam Nasheetha Nasheed- Director, Ministry of Gender, Family and Social Services
- Aminath Nizar- Project Director- Ministry of National Planning and Infrastructure.
- Ahmed Aiman Shareef- Project Coordinator, Greater Male' Industrial Zone
- Shamau Shareef- Deputy Mayor- Male' City Council
- Jerome Manuel- Area Chief Engineer- Centara Resort

### *Points presented:*

- A series of stakeholder consultations would be held.
- An overview of the project through a video of the project was presented.
- It was noted that until the incinerator is operational, the waste collected would be bailed and kept.
- Participants were informed that emissions and impacts from the project would be within accepted levels
- Participants were informed numerous studies such as arithmetic surveys, marine surveys and dispersion modelling were conducted to ensure there were no impact on the environment.
- Participants were informed that the results from the marine survey indicated the sediment from the proposed site were more deteriorated than from the outside, but were within acceptable levels as per New Zealand standards
- It was noted that the ambient air quality was measured and that it showed that burning occurred during the weekdays.
- It was noted that a German model had been used for pollutant dispersion modelling and that it indicated that there was no impact from the 50m stake.
- Participants were informed that surveys were conducted for where the outfall for the cooling process would be and that it had indicated the coral colour was good in the southern part.
- It was informed that the water dispersion model was modelled at depths of 10m, 20m, 30m from the mean sea level for temperatures 5 degrees, 7.5 degrees and 10 degrees. It was noted temperatures greater than 10 degrees were not considered as per EPA's recommendation and that even at 10 degrees despite being indicated as red there was not much difference from the ambient depth.

## C



### Ministry of Environment

Male', Republic of Maldives.

ދިވެހިސަރުކާރުގެ ގެޒެޓް ގައި ބަޔާންކުރި ގޮތުގައި  
މިއަހަރުގެ ފެބްރުއަރީ 2023 ވަނަ އަދަދުގައި

- A participant raised concern that a German model had been used and it was informed that this was a normal model.
- Participants inquired if the project had considered the increasing population, development projects and increased resorts expected in the zone. It was informed that the growth had been forecasted and taken into consideration during the feasibility studies.
- A participant inquired how the "oily waste" would be generated and it was informed that the primary focus of the project was addressing the solid waste issue in the country.
- A participant voiced that currently depending on the direction of wind many activities planned in the resort have to be cancelled due to the flies and smoke. It was inquired if smoke emissions from the WTE would be seen and how the issue of floating waste in the sea would be addressed, It was informed that there would be no smoke to be seen from the WTE plant and that all waste would be collected and transported by WAMCO in containerized vehicles in the sea thus there would be no spillage of waste.
- Participant inquired if during the transition period any measures would be taken to address the flies and it was informed that the waste collected would be covered.
- 
- A participant raised concerns that some resorts and individuals would still continue dump in the sea if they did not want to pay for the services of WAMCO.
- A participant inquired if there was any monitoring mechanism to assess the impact on the health of the people once the project is implemented. It was noted that this was something which could be considered.
- It was suggested to put an additional road in Thilfaushi to accommodate the increased traffic and future development projects. However, it was noted that the increased traffic would not be enough to justify a road.
- It was agreed to have a discussion with the City Council and Greater Male' Industrial Zone Pvt Ltd to discuss ongoing projects
-

C



**Ministry of Environment**

Male', Republic of Maldives.

ދިވެހިސަރުކާރުގެ ގެޒެޓް ގައި ބަޔާންކުރި ގޮތުގައި  
މިނިސްޓްރީ އޮފް ޕްރޮޓެކްޝަން އަންދު ޕްރޮޓެކްޝަން

## Minutes of the Meeting

**Meeting Title:** GMEIWP ADB Mission Meetings- Stakeholder Consultation (Thilafushi)

**Date:** 6<sup>th</sup> August 2019

**Location:** Ministry of Environment

### *Participants:*

- Ministry of Environment (ME)
  - Mohamed Asif- Social and Environmental Safeguard Specialist.
  - Hana Farook- Assistant Project Coordinator
- Asian Development Bank (ADB)
  - Luca Di Mario- Urban Development Specialist/Project technical Leader
  - Ninnete Pajarillagu- Environment Specialist
  - Emma Marsnene- Senior Environmental Specialist
  - Miguel Diangan Jr- Environment Safeguards Consultant
- Asian Infrastructure Investment Bank (AIIB)
  - Irish Fe Aguilar- Social Development Specialist
- Water Solutions
  - Ahmed Jameel- Senior Consultant
  - Mohamed Umar- Junior Environmental Consultant.
- Others
  - Hisham- Assistant Manager, Asrafee
  - Hassan Zareer- General Manager, Maldives Ports Limited
  - Ahmed Ibrahim- Manager, MPL
  - Ali Nashid, GM, Target
  - Mohamed Akman- Admin, Agas Maldives

## C



### Ministry of Environment

Male', Republic of Maldives.

ދިވެހިސަރުކާރުގެ ގެޒެޓް ގައި ބަޔާންކުރި ގޮތުގައި  
މިއަހަރުގެ ފެބްރުއަރީ 2023 ވަނަ އަދަދުގައި

- A participant raised concerns that there were many unutilised lots/sites in Thilafushi and that it had become a hub for many migrant workers. It was also noted that these placed had very poor living standards and that it needed to be looked into.
- A participant suggested to incorporate the cooling system inside the plant, as it could have an impact on the corals and reefs. It was noted that due to STELCO's cooling system in the sea, the corals and reefs were being affected. Member stressed the importance of ensuring the reef is not affected and suggested to keep the cooling system 30 meters deep and 30 meters away from the reef.
- A participant inquired how the waste would be segregated and sorted, and requested for more details. Participant stressed that lease waste, mercury, hazardous waste needs to be segregated and if not the bottom ash would contain harmful residuals.
- When inquired, participants mentioned that the current state of Thilafushi poses health risks to their employees such as irritation of eyes, ears and skin, and also difficulty in breathing and an overall decline in health which increased absenteeism, affecting the productivity.
- When inquired if anyone in Thilafushi fished in the area, it was highlighted that it was possible some migrant workers may do so.
- It was agreed to share the exact location of the business lots.



**Minutes of the  
Public Hearing for the EIA for the Regional Waste Management Facility at Zone 3 in  
Thilafushi**

Venue: Auditorium, Ministry of Environment, Male', Maldives

Date: 4<sup>th</sup> September 2019

Time: 1400 hrs

---

## **1. Welcome**

Mr. Ahmed Murthaza, Director General, Ministry of Environment thanked everyone for attending the public hearing held as part of the EIA carried out for the Regional Waste Management Facility to be established at Thilafushi for zone III in the Maldives. Mr. Murthaza noted that the meeting was organized by Ministry of Environment for a request by Water Solutions Pvt Ltd as the EIA consultant for the project. Public Hearing is part of the EIA work that is being carried out for the project in accordance with ADB Safeguard Policy and EIA Regulation implemented by EPA. Mr. Murthaza introduced the project team.

The main component of the Regional Waste Management Facility, includes, the waste to energy facility and the residual landfills at Thilafushi, which would be developed under a Design Build Operate (DBO) contract where the Design-Build period is expected to be 3 years. The Operation Service period is 15 years. The Design-Build of the facility will be funded by the Government of Maldives using the proceeds of a loan co-funded by the Asian Development Bank (ADB), the Asian Infrastructure Investment Bank (AIIB), and the Islamic Development Bank (ISDB). The Operation Service component of the DBO contract will be funded by the Ministry of Environment and Energy (ME).

## **2. Purpose of the Meeting**

Mr. Ahmed Murthaza explained that the purpose of the meeting was to inform public about the Thilafushi Regional Waste Management Project as well as the EIA process that is currently underway. The public meeting were to inform public and other stakeholders of the identified key issues, to provide public and stakeholders the opportunity to raise additional issues or concerns that have not been identified in the EIA.

## **3. Presentation**

Mr. Mohamed Asif, Social and Environmental Safeguards Specialist - Greater Male' Environment Improvement and Waste Management Project, Ministry of Environment presented an overview of the project. He provided details of the Greater Male' Environment Improvement and Waste Management Project components including the waste to energy component which is the establishment of the waste to energy facility as part of the Regional Waste Management Facility at Thilafushi for Zone III. In his presentation he presented an overview of the ADB Safeguard Policy Statement (SPS) noted the components that is relevant to this project. He noted that EIA has been prepared in accordance with the requirements of ADB Safeguard Policy Statement, which categorized the Thilhafushi waste project as Category A, that required to undertake an EIA and the Terms of Reference (TOR) issued by the Environmental Protection Agency.

In his presentation, he presented the Grievance Redress Mechanism that had been developed for the project. He provided details of the mechanism outlining how the grievances could be addressed at First level, Second Level and Third Level where an individual or an interest group has the option of going to established judiciary system of the Maldives with their grievances.

Mr. Ahmed Jameel, EIA Consultant at Water Solutions provided a detail presentation of the findings of the EIA that carried out for the Regional Waste Management Facility at Thilafushi for Zone III project. During the presentation, he provided details of the proposed Greater Male' Waste to Energy at Thilhafushi and provide a details of the context and rationale for the project. He explained the purpose of the EIA that had been carried out for the project and detail out the objectives of the EIA. The Terms of Reference issued for the project from EPA was presented and highlighted the key issues that was highlighted in the TOR. The EIA Consultant presented the approach the EIA team took undertake the EIA Study. The findings of the study was presented in very details including the existing environment of the study area focusing on the

---

physical environment providing the details of the topography of the site, marine water and sediment quality. Marine environment of study area was presented by covering the coral reef, marine water quality and sediment quality. The context of climate change and disaster risks were presented. The legislative and regulatory consideration which is important to the project was highlighted. The results of the air quality monitoring that was carried out for the baseline monitoring were presented.

After presenting the existing environment of the project site, significant environmental impacts were presented. These includes the environmental impacts during the construction stage and operation phase of the project. During the presentation, a very detail account of the hot water dispersion modelling work that was carried to study the impacts of hot water on the marine environment, air pollutant dispersion from the stack emission was presented.

One of the objectives of the EIA is to minimize or avoid environmental impacts from the project activities. The aspects that had been integrated into the design of the project was highlighted which are part of the impact mitigation measures identified in the EIA. Similarly the mitigation measures that was recommended to be undertaken during the construction and operation phase of the project were presented.

The alternatives to the project were also presented. Some of these were considered during the early stage of the project development.

As a last component of the presentation was the presentation of the Environmental Management Plan proposed for the project. This included the proposed environmental monitoring to monitor the impacts of the project during the construction and operation phase of the development. Additionally Health and Safety, Environmental Management Capacity and proposed Environmental Emergency Response Plan was presented.

#### **4. Questions and Discussion.**

It was asked if the residents of the area would benefit from this project.

*Mr. Asif stated that the residents of Male', Villingili, Gulheefalhu and people working at Thilafushi would benefit directly from this project. The project would extinguish the smoke from Thilfushi dumpsite and waste to energy facility will help to manage, treat and dispose waste in a manner an acceptable way that will have no impact on the communities living around the facility. He explained that the project would also generate jobs for the entire region, not just the community.*

A participant asked why a large Incinerator has been proposed to manage the waste. He asked why sorting and reuse of waste has been not proposed as the method to manage the waste that is generated from Greater Male' Region.

*Consultant answered to the question by saying that 3R strategy has been considered while developing the Regional Waste Management Project for the Greater Male' region and Zone III. Waste to Energy facility was considered as a measure to reduce the volume of waste that would go final landfilling as bottom ash and fly ash. Presently allocated land for land filling can be used for 15 years without bottom ash recycling. If bottom ash can be reused, then the life the landfill would be extended. Due to this reason the other methods for final treatment of waste has not been feasible in the Maldives.*

A participant raised the question that incinerator would be fueling by high calorific materials such as plastics and this would become a disincentive to minimize the use of single use plastic.

*Though waste to energy is main component of the regional waste management system at Thilhafushi, the sorting of the waste could be carried out at source, at transfer station and at*

---

waste receiving area of Thilfushi. The waste management system developed for the Zone III does not discourage sorting, reduction of single use plastic and reuse of waste. These streams would improve in the future as a result of the public awareness and education programs that would be implemented as part of the project.

A participant raised the question that waste to energy plant will burn all type of waste. This will move the public away from sorting of the waste at source such as household and offices.

*Consultant replied during the feasibility study stage of the project different methods and technologies for the management of waste was considered.*

*saying that a sorting facility cannot be accommodated in the Male' transfer station and there will be a civic amenity facility at Hulhumale' where people can bring in their sorted waste.*

A participant raise the question that he wanted to know how much the tax payers will be paying to the DBO contractor to run the waste to energy plant at Thilafushi

*Consultant replied that WAMCO or ME will establish a tariff system. Operator will charge a gate fee as well. Taxpayers will have to subsidize the management of waste. Mr. Murthaza clarified that the Ministry and the project team is in discussion to work out a tariff system that would not be a burden the public but it would generate enough revenue to keep the operations in a sustainable mode.*

A participant raise the question that why Ministry of Energy is undertaking an energy project not a waste management project to address the current urgent waste issue at Thilafushi.

*Mr. Murthaza answered to this question. He stated that the Ministry of Environment has no intention of implementing an energy project. The proposed project is a waste management project. Waste to Energy specialist working for this project have noted that the waste incinerator with or without the waste to energy system would have no impact on the efficiency of the incinerator. However with a waste to energy system, the plant can generate 8MW of electricity which can be used for Thilafushi and for the Greater Male' Region with the government vision of having a bridge which connects Male' to Thilafushi.*

A participant raise the question that hazardous and medical waste cannot be treated at a waste to energy plant. So how this kind of waste generated in Male' can be managed or treated.

*It was noted from the consultant that waste to energy plant can manage small quantity of the waste. However batteries should not be incinerated. Mr. Murthaza replied that the hazardous waste would be separated, stored in appropriate containers.*

A participants raised the issue of ownership of the energy that would be produced from the Waste to Energy facility and other valuable by products.

*Mr. Murthaza. replied that the ownership and responsibility of the products from Waste to Energy facility has not been decided. This includes energy from waste to energy, metals and bottom ash. Excess energy will be converted into hot water and discharge to the sea. One of the options that is being discussed to have a business model would be made to determine a percentage of profit from sale of such projects to the operator.*

A participant enquired when the open burning will stop at Thilafushi.

*Mr. Asif replied stating that one of the most priority of the project is to stop the burning and extinguish the smoke from Thilafushi. The project is trying to procure urgently needed equipment to better manage the existing dumpsite at Thilfushi. With this intervention, WAMCO will be able to cover the waste that is dumped to the waste mount on a daily basis which will*

---

*prevent the fire and smoke. The project is also recruiting an expert on managing the dumpsite who will train and oversee the operation of WAMCO at Thilafushi dumpsite.*

A participant enquired about the capacity of the incinerator that had been designed for and if the design foresees a decrease in waste generation.

*The consultant explained that during the feasibility stage a number of scenarios was considered. The proposed design has a number of mechanism to mitigate the risk either waste received is higher than the forecasted amount or lower than the forecasted value. Waste generation of 500 tonnes per day without CnD waste is expected for 2022. Waste is also expected to increase from the tourism industry and after the airport development project is completed. There needs to be policy level changes to incorporate and implement sorting and waste reduction, such has less packaging. These would help to lower the growth of amount of waste generation. This can delay the construction of the third line in the waste to energy facility.*

A member of the community enquired whether they could see the final draft of the EIA and the studies that had been completed as part of the project. He also enquired whether he could submit comments to EIA when it released to the public.

*The consultant explained that the draft final report will be made public at ADB and EPA website. ADB will make it public for commenting for 3 months as part of the ADB ADB Safeguard Policy Statement for Category A project. Hence the public is encouraged to submit comments and concern to the project. Mr. Asif also explained that through the Grievance Redress Mechanism for the project, the public can address their Grievances to the project during the project implementation stage. Any comments or concern raised would be considered by the project team.*

## **5. Closure**

The meeting ended at 1530.

## Photos from the Public Hearing Meeting



ދިވެހިސަރުކާރުގެ ގެޒެޓް ގައި ބަޔާންކޮށްފައިވާ ގޮތުން  
MINISTRY OF ENVIRONMENT

ދިވެހިސަރުކާރުގެ ގެޒެޓް ގައި ބަޔާންކޮށްފައިވާ ގޮތުން  
THILAFUSHI REGIONAL  
WASTE MANAGEMENT FACILITY

ދިވެހިސަރުކާރުގެ ގެޒެޓް ގައި ބަޔާންކޮށްފައިވާ ގޮތުން  
EIA PUBLIC CONSULTATION

ދިވެހިސަރުކާރުގެ ގެޒެޓް ގައި ބަޔާންކޮށްފައިވާ ގޮތުން  
Environment Ministry Auditorium

4 ވަނަ ސެޕްޓެމްބަރު 2019 (ބުދަ)  
4th September 2019 (Wednesday)

13:00hrs

ދިވެހިސަރުކާރުގެ ގެޒެޓް ގައި ބަޔާންކޮށްފައިވާ ގޮތުން  
OPEN TO PUBLIC





**Minutes of the Focus Group Discussions  
EIA for the Regional Waste Management Facility at Zone 3 in Thilafushi**

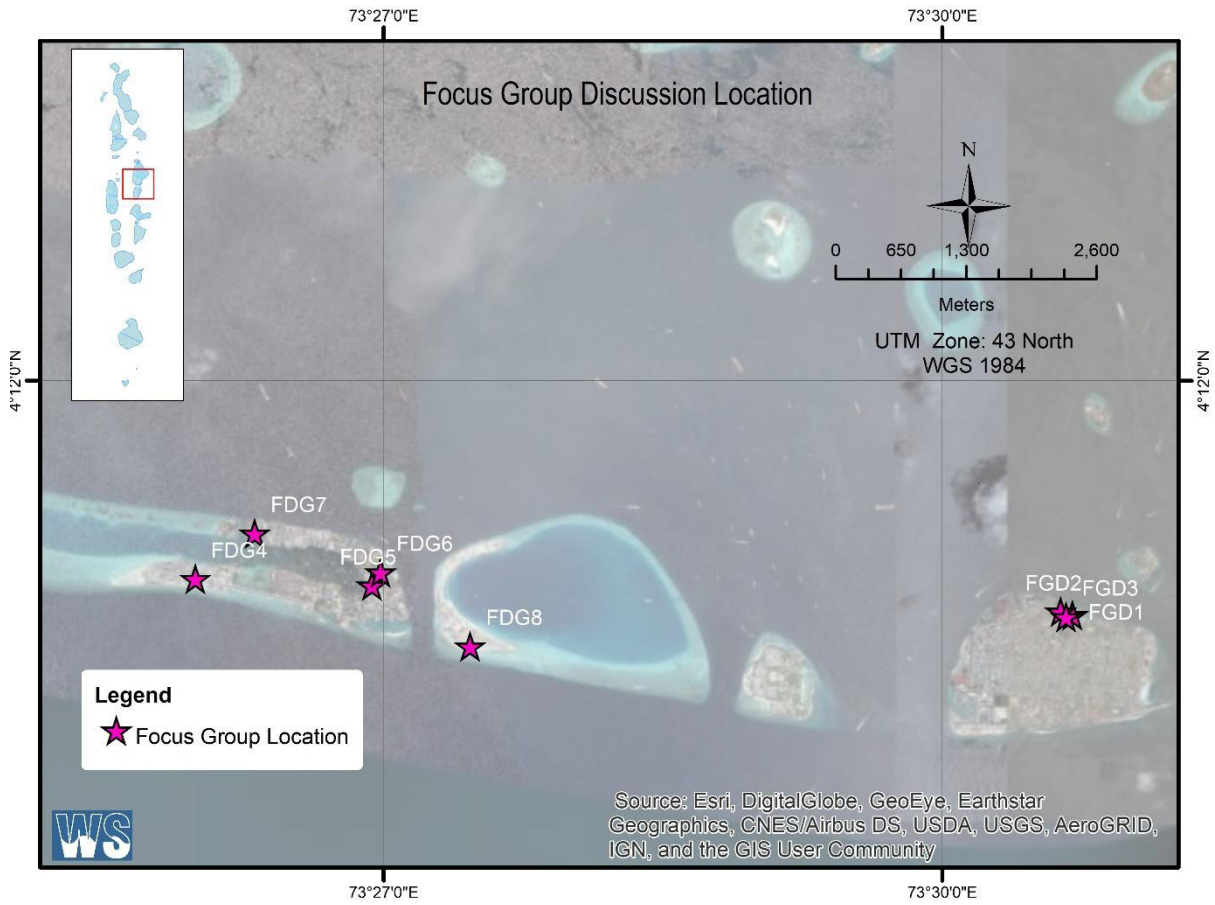


---

## Table of Contents

1	Locations where Focus Group Discussion were held .....	3
2	Focus Group Discussions 1 .....	4
3	Focus Group Discussions 2 .....	6
4	Focus Group Discussions 3 .....	8
5	Focus Group Discussions 4 .....	11
6	Focus Group Discussions 5 .....	13
7	Focus Group Discussions 6 .....	15
8	Focus Group Discussions 7 .....	18
9	Focus Group Discussions 8 .....	21

# 1 Locations where Focus Group Discussion were held



---

### 3 Focus Group Discussions 1

Venue: Jumhoori Park, Male', Maldives

Date: 30<sup>th</sup> August 2019

Time: 1630 hrs

A focus group discussion was carried out with the expatriates living in Male'. The expatriate communities comes to the Jumhoori Park Public Square on Friday afternoon. The participants of the FGD were presented the Greater Male' Environment Improvement and Waste Management Project by Mr. Mohamed Asif, Social and Environmental Safeguards Specialist - Greater Male' Environment Improvement and Waste Management Project, Ministry of Environment. Mr. Ahmed Jameel, EIA Consultant at Water Solutions provided the findings of the EIA to the group members. Colour Maps printed on A3 was used as aid to show the present situation of Thilafushi, the proposed Greater Male' Waste to Energy Project and bird eye view of Thilafushi after the completion of the project.

The FDG were women and all of them in the group have not been to Thilafushi. They are mostly domestic workers working at houses in Male'. However they have seen the smoke rising from Thilafushi from western side of Male'. Some of them said they have experience the bad smell coming from Thilafushi on some days.

Some of the members in the group said they have friends who have visited Thilafushi and they said the island has a very big waste dumpsite. Some days the waste site is on fire.

The group felt that improving the waste management at Thilhafushi will improve the condition of people working at the island.

#### Closure

The meeting ended at 1700 hrs

#### Attendance - Focus Group Discussions 1

Following people were at FDG. Most of the people in the group were reluctant to give details of their contact.

Name	Gender	Country	Contact
Latha	Female	Work as a housemaid. Expatriate from India	-
Nirumalee	Female	Work as a housemaid. Expatriate from India	-
Dharushinee	Female	Work as a housemaid. Expatriate from India	-
Charanjeet	Female	Work as a housemaid. Expatriate from India	-
Phrajeet	Female	Work as a housemaid. Expatriate from India	-
Anjali	Female	Work as a housemaid. Expatriate from India	-
Gittu	Female	Work as a housemaid. Expatriate from India	-
Paramjit	Female	Work as a housemaid. Expatriate from India	-
Baljeet	Female	Work as a housemaid. Expatriate from India	-
Mamta	Female	Work as a housemaid. Expatriate from India	-
Thn	Female	Work as a housemaid. Expatriate from India	-
Sarita	Female	Work as a housemaid. Expatriate from India	-

---

**Photos from the Focus Group Discussions 1**



---

## 4 Focus Group Discussions 2

Venue: Jumhoori Park, Male', Maldives

Date: 30<sup>th</sup> August 2019

Time: 1710 hrs

A focus group discussion was carried out with the expatriates living in Male' at Jumhoori Park Public Square on Friday afternoon. The participants of the FGD were presented the Greater Male' Environment Improvement and Waste Management Project by Mr. Mohamed Asif, Social and Environmental Safeguards Specialist - Greater Male' Environment Improvement and Waste Management Project, Ministry of Environment. Mr. Ahmed Jameel, EIA Consultant at Water Solutions provided the findings of the EIA to the group members. Colour Maps printed on A3 was used as aid to show the present situation of Thilafushi, the proposed Greater Male' Waste to Energy Project and bird eye view of Thilafushi after the completion of the project.

Everyone in the group knows about Thilafushi as they know it is place they can find work easily. Some of them have been Thilhafushi and knows about the smoke and its impact on the people on the island. Most of the people in the group were employed as construction workers working at construction sites in Male'.

The group felt that improving the waste management at Thilhafushi will improve the condition of people working at the island.

### Closure

The meeting ended at 1730 hrs

### Attendance - Focus Group Discussions 2

Following people were at FDG. Most of the people in the group were reluctant to give details of their contact.

Name	Gender	Country	Contact
Akash	Male	Expatriate from Bangedhesh working as a construction laborer	-
Shahidul	Male	Expatriate from Bangedhesh working as a housemaid	-
Prito	Male	Expatriate from Bangedhesh working as a construction laborer	-
Manzoor	Male	Expatriate from Bangedhesh working as a house helper	-
Anawar	Male	Expatriate from Bangedhesh working as a construction laborer	-
Hossain	Male	Expatriate from Bangedhesh working as a house worker	-
Sarker	Male	Expatriate from Bangedhesh working as a construction laborer	-
Munes	Male	Expatriate from Bangedhesh working as a house helper	-
Wasif	Male	Expatriate from Bangedhesh working as a construction laborer	-
Reza	Male	Expatriate from Bangedhesh working as a construction laborer	-
Athiu	Male	Expatriate from Bangedhesh working as a paint worker	-
Sharee	Male	Expatriate from Bangedhesh working as a house helper	-

---

**Photos from the Focus Group Discussions 2**



---

## 5 Focus Group Discussions 3

Venue: Jumhoori Park, Male', Maldives

Date: 30<sup>th</sup> August 2019

Time: 1740 hrs

A focus group discussion was carried out with the Maldivians living in Male' at Jumhoori Park Public Square on Friday afternoon. The group mainly had Maldivian women who were at the park. The participants of the FGD were presented the Greater Male' Environment Improvement and Waste Management Project by Mr. Mohamed Asif, Social and Environmental Safeguards Specialist - Greater Male' Environment Improvement and Waste Management Project, Ministry of Environment. Mr. Ahmed Jameel, EIA Consultant at Water Solutions provided the findings of the EIA to the group members. Colour Maps printed on A3 was used as aid to show the present situation of Thilafushi, the proposed Greater Male' Waste to Energy Project and bird eye view of Thilafushi after the completion of the project.

Everyone in the group knows about Thilafushi. Some of the women were from islands who were visiting Male'. Everyone in the group knew Thilafushi is the island where waste is taken from Male'. They said the waste taken at Thilafushi is burnt as they have seen smoke rising from big mountain at Thilafushi. Some people in the group said some days, they can smell really bad from the smoke coming from Thilafushi. The people in the group said the smoke at Thilafushi need to be stopped. A group member asked when the fire will be stop at Thilafushi. She was told that one of the main priority of the project is to stop smoke risking and this is an urgent work that will be carried out. The group was informed that the implementation of the Greater Male' Waste to Energy Project will not have visible smoke emitting from the long stack that would be constructed at Thilafushi.

The group felt that improving the waste management at Thilafushi will improve the condition of people working at the island.

As we were concluding the FGD, Vice President of Maldives came to the park with his son. He met the members of the FGD.

### Closure

The meeting ended at 1800 hrs.

### Attendance - Focus Group Discussions 3

Following people were at FDG. Most of the people in the group were reluctant to give details of their contact.

Name	Gender	Country	Contact
Nadheema	Female	Maldivian	-
Amira	Female	Maldivian	-
Shareef	Female	Maldivian	-
Fathimath	Female	Maldivian	-
Aishath	Female	Maldivian	-
Nihaani	Female	Maldivian	-

---

**Photos from the Focus Group Discussions 3**







---

## 6 Focus Group Discussions 4

Venue: Thilhafushi, Maldives

Date: 1<sup>st</sup> September 2019

Time: 1000 hrs

A focus group discussion was carried out with the people working at Thilhafushi, west of the proposed waste to energy project site. The group mainly had expatriate workers and Maldivian supervisor who were doing some construction work at Thilhafushi. The group members said that they have been working at Thilafushi over a year. All of the group members comes to work at Thilhafushi in the morning and leave to Male' in the afternoon. They take the public ferry to Thilhafushi.

The participants of the FGD were presented the Greater Male' Environment Improvement and Waste Management Project by Mr. Mohamed Asif, Social and Environmental Safeguards Specialist. Mr. Ahmed Jameel, EIA Consultant at Water Solutions provided the findings of the EIA to the group members. Colour Maps printed on A3 was used as aid to show the present situation of Thilafushi, the proposed Greater Male' Waste to Energy Project and bird eye view of Thilafushi after the completion of the project.

Everyone in the group knows about smoke issuing facing Thilafushi as they have to cross the site on a daily basis. The group member said, the situation of smoke depends on the wind direction. If they have to work downwind, the situation becomes very difficult. Some days, they have to stop work because the smoke makes it impossible for them to work. The group members said, urgently the smoke issue need to be addressed and better waste management need to implement at Thilhafushi. The group member said they have seen a number of development near the waste dumpsite. They pointed out new land had been reclaimed and new equipment had been installed to manage the waste.

A group member asked when the fire will be stop at Thilafushi. He was told that one of the main priority of the project is to stop smoke risking and this is an urgent work that will be carried out.

The group felt that improving the waste management at Thilhafushi will improve the condition of people working at the island. They said they hope that the big stack at the new waste to energy plant will not have any visible smoke emitting from the long stack that would be constructed at Thilhafushi.

### Closure

The meeting ended at 1030 hrs.

---

#### Attendance - Focus Group Discussions 4

Following people were at FDG.

Name	Gender	Country	Contact
Abdul Mannan	Male	Maldivian	7967447
Al Ameen	Male	Expatriate from Bangedhesh working as a construction laborer	-
Santil	Male	Expatriate from Bangedhesh working as a construction laborer	-
Mumeen	Male	Expatriate from India working as a construction laborer	-
Algiri	Male	Expatriate from Bangedhesh working as a construction laborer	-
Balaau	Male	Expatriate from India working as a construction laborer	-
Amir	Male	Expatriate from Bangedhesh working as a construction laborer	-
Shahid	Male	Expatriate from Bangedhesh working as a construction laborer	-
Haleem	Male	Expatriate from Bangedhesh working as a construction laborer	-

#### Photos from the Focus Group Discussions 4



---

## 7 Focus Group Discussions 5

Venue: Thilhafushi, Maldives

Date: 1<sup>st</sup> September 2019

Time: 1100 hrs

A focus group discussion was carried out with the people working at Heavy Force Site 2 at Thilhafushi. The site is located north east of the proposed waste to energy project site. A total of 8 people participated in the discussion: 6 were Bangladeshi and two were Maldivian. All of the Bangladeshi participants are employed under “laborer” visas. However, their work ranged from cleaning the barge to driving vehicles. The two Maldivians worked in supervisory positions. All of the group members has been living at Thilafushi for more than one year.

All of the participants said they would be willing to continue to work in their current jobs even though the site is impact from the heavy smoke from the waste dump site. At night Thilhafushi is a very quiet place. A participant told that at night, they would some time hear explosion from the dumpsite as bottles and canister catches fire.

The participants of the FGD were presented the Greater Male' Environment Improvement and Waste Management Project by Mr. Mohamed Asif, Social and Environmental Safeguards Specialist. Mr. Ahmed Jameel, EIA Consultant at Water Solutions provided the findings of the EIA to the group members. Colour Maps printed on A3 was used as aid to show the present situation of Thilafushi, the proposed Greater Male' Waste to Energy Project and bird eye view of Thilafushi after the completion of the project.

The group member said, the situation of smoke depends on the wind direction. If they have to work downwind, the situation becomes very difficult. Some days, they have to stop work because the smoke makes it impossible for them to work. During the discussion, issues related when the smoke would be extinguish, when the project start and what will to the surrounding area after the completion of the project were covered.

The group felt that improving the waste management at Thilhafushi will improve the condition of people working at the island.

### **Closure**

The meeting ended at 1100 hrs.

---

## Attendance - Focus Group Discussions 5

Following people were at FDG.

Name	Gender	Country	Contact
Shahid Haleem	M	Maldivian, Supervisor, Heavy Force	7902107
Hussain Fayaz	M	Maldivian, Excavator Driver, Heavy Force	7920107
Haithim	M	Bangladesh, Labourer, Heavy Force	
Sumon MD	M	Bangladesh, Labourer, Heavy Force	
Shibu bai	M	Bangladesh, Labourer, Heavy Force	
MD Suhail	M	Bangladesh, Labourer, Heavy Force	
MD Turaab	M	Bangladesh, Labourer, Heavy Force	
MD Suraab	M	Bangladesh, Labourer, Heavy Force	

## Photos from the Focus Group Discussions 5



---

## 8 Focus Group Discussions 6

Venue: Waste Management Site at Thilhafushi, Maldives

Date: 1<sup>st</sup> September 2019

Time: 1230 hrs

A focus group discussion was carried out with the people working at Thilhafushi waste management site. The focus group discussion was held at WAMCO Office during their lunch time break hours. A total of 13 people participated in the discussion: 11 were Bangladeshi and two were Maldivian. All of the Bangladeshi participants are employed under work permit working at Thilafushi. Their work ranged from cook to excavator drivers. The two Maldivians worked in supervisory positions. Most of the group members has been living at Thilafushi for more than one year. The supervisors comes to Thilhafushi to work and return back to Male' in the afternoon. They take the public ferry to Thilhafushi.

The participants of the FGD were presented the Greater Male' Environment Improvement and Waste Management Project by Mr. Mohamed Asif, Social and Environmental Safeguards Specialist. Mr. Ahmed Jameel, EIA Consultant at Water Solutions provided the findings of the EIA to the group members. Colour Maps printed on A3 was used as aid to show the present situation of Thilafushi, the proposed Greater Male' Waste to Energy Project and bird eye view of Thilafushi after the completion of the project.

Everyone in the group are familiar with smoke issuing facing Thilafushi as they work at the waste management site on a daily basis. Most of the members of the group have bad experiences working in the smoking conditions. Some said, they get red eyes when they work and others said they get throat infection. Some say, they have to take sick leave on regular basis.

The members of the group said, the smoke from the dumpsite could be extinguish when they get additional heavy machineries to handle the waste and manage the dumpsite. The group felt that improving the waste management at Thilhafushi will improve the condition of people working at the island. All of the participants said they would be happy to continue to work at Thilhafushi when the dumpsite if properly managed. Some of the participants said they did not have any concerns of losing their job in the future, when the project is completed.

### Closure

The meeting ended at 1300 hrs.

---

## Attendance - Focus Group Discussions 6

Following people were at FDG.

Name	Gender	Country	Contact
Hazim Ibrahim	M	Maldivian, Assistant Manager, WAMCO	799146
Mohamed Asraf	M	Maldivian, Supervision, WAMCO	9908430
Mohamed Yoosuf	M	Bangladesh, Driver, WAMCO	
Sadir	M	Bangladesh, Driver, WAMCO	
Asadhul	M	Bangladesh, Driver, WAMCO	
Narayan	M	Bangladesh, Lorry Driver, WAMCO	
Oulal	M	Bangladesh, Labor, WAMCO	
Halim	M	Bangladesh, Cook, WAMCO	
Habib	M	Bangladesh, Lorry Driver, WAMCO	
Sohel	M	Bangladesh, Lorry Driver, WAMCO	
Sadik	M	Bangladesh Lorry Driver, WAMCO	
Muneer	M	Bangladesh, Lorry Driver, WAMCO	
Faisal	M	Bangladesh, Lorry Driver, WAMCO	

## Photos from the Focus Group Discussions 6







---

## 9 Focus Group Discussions 7

Venue: Thilhafushi, Maldives

Date: 2<sup>st</sup> September 2019

Time: 0930 hrs

A focus group discussion was carried out with the people working at the MTCC Boat Yard at Thilhafushi. All participants were male and their age ranged from 30 years to 50 years. The site is located directly north of the waste dumpsite at Thilafushi. The group mainly had Maldivian working at the site. Most of the members of the group had been working at Thilafushi for a long time. Some of the members in the group works and live at the site at Thilafushi. There was a high rate of job satisfaction amongst the workers. Their key reasons include high salaries, regular pay and good benefits such as food and accommodation. The group members said around 100 people work at Thilafushi site. The work at the site requires them to work outdoors all the time. Hence it makes very difficult during south west monsoon as most of the days the site is covered by the smoke. The

Most of them, especially the supervisors believed that the equipment in the Waste Management Section need to be upgraded immediately. The constant smoke from open burning, particularly during southwest monsoon when their site is directly in the path of the smoke plume, causes discomfort. Some workers said that they have got used to it and thus they no longer are able to understand its effects.

The participants of the FGD were presented the Greater Male' Environment Improvement and Waste Management Project by Mr. Mohamed Asif, Social and Environmental Safeguards Specialist. Mr. Ahmed Jameel, EIA Consultant at Water Solutions provided the findings of the EIA to the group members. Colour Maps printed on A3 was used as aid to show the present situation of Thilafushi, the proposed Greater Male' Waste to Energy Project and bird eye view of Thilafushi after the completion of the project.

Everyone in the group knows about smoke issuing facing Thilafushi as they see it every day which is across the bay on other side of their site. The group member said, the situation of smoke depends on the wind direction. If they have to work downwind, the situation becomes very difficult. Some days, they have to stop work because the smoke makes it impossible for them to work. Even when they come indoors, the smoke will fill the rooms and the smoke will come through the air conditioning unit. The group members said, urgently the smoke issue need to be addressed and better waste management need to implement at Thilhafushi. The group were brief that one of the activity of the project is to stop the smoke coming from the exiting dump and it will happen early next year. The group members said that because of the smoke and current situation at Thilafushi, they are unable to attract good talents and experience professionals to work at the boat building yard at Thilhafushi.

A group member said he have seen a number of cases where the workers get stick and he believes it is due to the smoke. Improve the situation at Thilafushi waste site with the proposed project will have a very positive impact on industries at Thilafushi. They would be able to improve their services by attracting good and experience professional to work at their site.

The group felt that improving the waste management at Thilhafushi will improve the condition of people working and living at the island. Everyone welcomes the project said they are hoping the implementation of the project would commence soon. They said they hope that the big stack at the new waste to energy plant will not have any visible smoke when it becomes operational.

### Closure

The meeting ended at 1030 hrs.

---

## Attendance - Focus Group Discussions 7

Following people were at FGD

Name	Gender	Country	Contact
Moahmed Husham	M	Maldivian, General Manager, MTCC	7773653
Abdulla Abdu Shakoor	M	Maldivian, Manager, MTCC	791220
Mohamed Rasheed	M	Maldivian, Engineer, MTCC	7785716
Mohmed Fahty	M	Maldivian, Engineer, MTCC	7747379
Iqbal	M	Maldivian, Engineer r, MTCC	7708026
Sameeu	M	Maldivian, Engineer, MTCC	7914961
Ghina	M	Maldivian, Engineer, MTCC	
Inrhaim Mohamed	M	Maldivian, Accounts Officer, MTCC	7795575
Abdul Shafeeu	M	Maldivian, Welder Supervisor, MTCC	7795575
Abdul Hussam	M	Maldivian, Senior Engineer MTCC	78397615

## Photos from the Focus Group Discussions 7



---

## 10 Focus Group Discussions 8

Venue: Gulheefalhu, Maldives

Date: 2<sup>st</sup> September 2019

Time: 1130 hrs

A focus group discussion was carried out with the people working and living at Gulheefalhu. Gulheefalhu is an island which is located east of Thilafushi. The group mainly Maldivian working at Greater Male' Industrial Zone Limited. The group members said that they have been working at Gulheefalhu over many years. There was one member of the group who had work at Thilafushi waste management site before he joined Greater Male' Industrial Zone Limited. He said working at Gulheefalhu is very comfortable than working at Thilafushi due to the smoke and difficulties related to the smoke. The group members said, Gulheefalhu is impact during south west monsoon on some days when the wind takes smoke over the island from Thilafushi waste dump site. Some of the group members comes to work at Gulheefalhu in the morning and leave to Male' in the afternoon. They take the public ferry to Male' from Gulheefalhu. Others live in Gulheefalhu.

The participants of the FGD were presented the Greater Male' Environment Improvement and Waste Management Project by Mr. Mohamed Asif, Social and Environmental Safeguards Specialist. Mr. Ahmed Jameel, EIA Consultant at Water Solutions provided the findings of the EIA to the group members. Colour Maps printed on A3 was used as aid to show the present situation of Thilafushi, the proposed Greater Male' Waste to Energy Project and bird eye view of Thilafushi after the completion of the project. The group were briefed that when the Greater Male' Waste to Energy project is implemented and the facility is operational in 2022/2023 there will be no emission from the stack of the incinerator.

Everyone in the group knows about smoke issuing facing Thilafushi. The group members said, urgently the smoke issue need to be addressed and better waste management need to implement at Thilafushi. The group member said they have seen a number of development near the waste dumpsite but the small incinerators that were installed at the site was a waste of money as it is not been used. The group was informed that those incinerators would be moved to other islands as these were installed temporarily.

A member of the group asked whether it is safe to fish from the Gulheefalhu house reef. The EIA consultant explained no government agency, including Health Protection Agency, Environmental Protection Agency or Marine Research Center has issued any notice restriction of fishing at the Gulheefalhu or Thilafushi House reef. It has been general practice that no fishing would be carried out from the reef nest to the waste dumpsite. Hence it would not advisable to fish from such reefs. The test carried out by the EIA team has not seen an increase of heavy metals in sediments and marine water that was sampled for the study.

The group felt that improving the waste management at Thilafushi will improve the condition of people working at Gulheefalhu. Gulheefalhu is a nice place to work, but the work condition gets deteriorated on some days because of the smoke from Thilafushi.

### Closure

The meeting ended at 1200 hrs.

---

## Attendance - Focus Group Discussions 8

Following people were at FGD.

Name	Gender	Country / Office	Contact
Ahmed Faisal	M	Maldivian, Greater Male' Industrial Zone	9930909
Mohamed Ziyaad	M	Maldivian, Greater Male' Industrial Zone	7912228
Mohamed Adil	M	Maldivian, Greater Male' Industrial Zone	7741234
Sheer Ahmed	M	Maldivian, Greater Male' Industrial Zone	9558184
Ahmed Ihrish	M	Maldivian, Greater Male' Industrial Zone	9724819
Ibrahim Razeed	M	Maldivian, Greater Male' Industrial Zone	7743049
Hassan Saeed	M	Maldivian, Greater Male' Industrial Zone	7753347

## Photos from the Focus Group Discussions 8





## Ministry of Environment

Male', Republic of Maldives.

ދިވެހިސަރުކާރުގެ ގެޒެޓް  
ދިވެހިރާއްޖޭގެ ޖުމްހޫރިއްޔާ

## Minutes of the Meeting

**Meeting Title:** Public Consultation for Environmental Impact Assessment (EIA) of Regional Waste Management Facility

**Date:** 28<sup>th</sup> October 2019

**Location:** MNU Auditorium

### Participants:

- Ministry of Environment (ME) -
  - Ibrahim Zameel Project Manager
  - Mohamed Asif Social and Environmental Safeguard Specialist
  - Sham'aan Shakir Information Education and Communication Specialist
  - Hana Farook Assistant Project Coordinator
- Waster Solution- EIA Consultant
  - Ahmed Jameel EIA Consultant
- Other Participants
  - Fathimath Rishana
  - Abdullah Adam
  - Ahmed Mohamed
  - Adam Isham
  - Humaida Abdul Gafoor
  - Ahmed Afrah Ismail
  - Mariyam Mohamed
  - Juma Ahmed
  - Aleef Naseem
  - Hoodh Ahmed
  - Mohamed Rasheed (Bari)
  - Abdul Aleem

## C



### Ministry of Environment

Male', Republic of Maldives.

ދިވެހިސަރުކާރުގެ ގެޒެޓް ގައި ބަޔާންކުރި ގޮތުގައި  
މިނިސްޓްރީ އޮފް ޕްލޭނިންގ ޕްރޮޖެކްޓް

### Points presented:

- Overview of the Project
- Results of the Environmental Impact Assessment of the Regional Waste Management Facility

### Issues raised *and response*:

#### Timing and venue of the public consultation

- Some of the participants raised concern that the timing of the public consultation was not ideal as it falls within the official working hours. A participant also suggested that the University Auditorium was not ideal and that the closed space would discourage people from attending the public consultation. It was suggested that future public consultations should be held after the official working hours in the evening and at a public space such as the “Jumhooree park” to encourage more people to attend.
  - *ME informed that the points mentioned would be taken into consideration for future public consultations*

#### High-level Technology fund

- A participant inquired what was meant by the high-level technology fund
  - *ME informed they would clarify and inform later. Towards the end of the discussion it was informed that a High-Level Technology Fund is a multi-donor trust fund that provides grant financing to encourage more widespread adoption of high-level technology (HLT) to address development challenges in ADB's developing member countries*

#### Capacity building

- A participant inquired since there is capacity building in phase 1, what was already being done to acquire information
  - *ME informed that a firm would be hired for capacity building activity and that that the firm would be working throughout the project to build the capacity of the community.*

#### Involvement of Women.

- A participant inquired why involvement of women was specified in awareness raising.
  - *ME noted that the project aims to increase the involvement of women throughout the different activities planned in the project and as such even the committee under the Grievance Redress Mechanism also specifies that the president of the island's women's committee be included. Women had been involved in all stages of the project development.*

#### Reduction of Waste

- A participant inquired the plans to reduce waste. Another participant added that instead of incinerating, the solution would be to reduce waste, and decrease the import of items that would create waste.
  - *ME informed that under the project there were plans to increase community awareness with regard to waste reduction. The EIA consultant added that there would be a focus on 3R under the community awareness and behaviour change strategies.*
- A participant raised concern that incineration was being used as the solution to reduce waste and stressed that incineration and re-using the ‘gunk’ from the incineration plant was not the solution.

## C



### Ministry of Environment

Male', Republic of Maldives.

ދިވެހިސަރުކާރުގެ ގެޒެޓް ގައި  
ބަޔާންކުރި ގޮތުގައި

- *In the management of waste, even after carrying out successful waste reduction strategies, there will be residual waste that need to be treated and disposed. Incineration has been recommended as an optimum technology for the Maldives. ME informed that the bottom ash could be utilised for road development and that currently a feasibility study was being undertaken.*
- A participant inquired if the government's pledge to reduce waste to 3 percent would have an impact on the operation of the plant.
  - *The proposed waste management strategy had taken account to waste reduction strategies. The proposed system would have no impact with current change of policy to ban the use of single use plastic by 2024.*

#### Public involvement for the whole project

- A participant raised concern that the public consultation was only for the regional waste management facility and not for the whole project.
- Moreover, it was added that public involvement should have been at an earlier stage, before incineration was chosen as the way forward to manage waste, as it is similar to the World Bank waste management project in Vandhoo which had failed.
  - *ME noted that the waste management project for Zone III has been formulated based on the lesson learnt from the Vandhoo Project. Vandhoo project was s a Design and Build project, and the project had failed because the operator of the facility was different and the Government took a while to handover the facility to WAMCO to run the facility. The current project for the Zone III is a DBO, Design, Built and Operate, building on the lessons from Vandhoo case..*
- A participant added that they were not aware of the level of consultations which had taken place with regard to the project. And that since all government infrastructure development projects (such as the Gulhifalhu Reclamation, development of resorts on shallow, development of harbours in the islands) are related, it needs to be considered, and Mministries and other big companies needs to consulted before undertaking such a project.
  - *ME informed that stakeholder consultations had taken place at all the stages of project formulation from feasibility to EIA. During the feasibility stage, stakeholders were consulted and stakeholder meetings were held. During the designing stage of the project, stakeholders were consulted. Various stakeholders and communities meeting were held for the EIA for this project in the past 24 months. During these meetings, relevant ministries, resorts and companies had also been invited to participate in the stakeholder meetings and workshops.*
- Many participants suggested that a multi sectoral discussion should be held for the consultation to be more meaningful. It was also noted that the outcome of the stakeholder meetings was not known to the public.
- A participant inquired how much the comments received from the public would be incorporated. Another participant also inquired if the minutes of the meeting would be available.
  - *ME informed that the project formulation has been guided by the inputs from stakeholders in different stages of the project. The minutes of the consultations will be included in the EIA*

#### Sustainability of the project

- A participant inquired how the project aligns to the SDG goals 1,2,3. He also added that the project had no engagement of the community. He also stressed that civil society should be part of the project instead of creating mega-companies. He also questioned if such a project would be financially sustainable and the dollar value of the cost to the community. He also inquired how the project would affect the human capital and enhance human development. He also drew

## C



### Ministry of Environment

Male', Republic of Maldives.

ދިވެހިސަރުކާރުގެ ގެޒެޓް ގައި ބަޔާންކުރި ގޮތުގައި  
މިނިސްޓްރީ އޮފް ޕްލޭނިންގ ޕްރޮޖެކްޓް ޕްރޮޖެކްޓް

examples of the Male' Sewerage Project which in his opinion had failed and did not work as designed, because there was no proper oversight from the regulator of the company.. He also highlighted that a gap between the design, installation and operation of a project could affect the sustainability of the project, thus a systematic approach would be needed. Another participant also questioned if the approach was sustainable.

- *ME noted that the various stakeholders including NGOs and Civil Society groups has been engaged in the project development. The project aims to build the overall institutional capacity in the country. And as such, improving the institutional capacity of EPA is a priority. Moreover, since it's a DBO (Design Build Operate) project, the operational issues would be minimized and local capacity would be developed before the operation is handed over to the Ministry/WAMCO at the end of the DBO period.*
- A participant inquired if ME could assure that project would be sustainable and the sustainability plans of the project. Similarly, another participant also questioned the sustainability of the project and inquired if all these aspects had been considered.
  - *ME informed that lessons from similar projects were being considered, and feasibility studies were undertaken to ensure the project was viable.*

#### No solution for bottom ash

- A participant raised concern that there was no solution for the bottom ash produced from the WTE facility. And stressed that before the project starts there should a proper way for it to be utilised as currently its only a study which is being undertaken.
  - *EIA consultant briefed that currently there is work going to study the alternative uses for the bottom ash. Presently the study is being focused to use the bottom ash on the production of paving blocks and other similar kind of use in the construction industry. It was also noted that a key objective of the project is to address the waste issue in Thilafushi.*

#### Producer responsibility and consideration of other government projects

- A participant inquired about the details of the grant and loans and suggested that producers should take responsibility of the waste they generate, and if not, it would be a misusing state funds. As such, she highlighted that resorts are one of the biggest generators of waste and that currently waste from all resorts are being taken to Thilafushi. Thus, the participant questioned how thoroughly the project had considered all these issues, and stated that the project seems like a reactionary project and a band-aid solution. She also inquired if the increasing number of resorts and other infrastructure projects had been considered. Another participant also inquired if the population growth in the Greater Male' region had been considered.
  - *EIA consultant briefed the waste to energy facility for the zone III is being financed by ADB through a grant/concessional loan. Resorts bring the waste to Thilafushi because current regulations requires the waste from the resorts to be brought to Thilafushi for disposal. The feasibility considered that waste generated from the resorts in the zone III would be brought to Thilafushi for treatment and disposal. WAMCO will be collecting the waste from the resort and the resorts will pay collection fee to WAMCO which includes the cost of treatment/disposal. The feasibility study considered the populations in the zone III, including the planned increase of resort beds in the region.*

#### EIA

- A participant also informed that they had been requesting for the EIA and was yet to receive it. Another participant also questioned the results of the EIA, as the participant stated that Thilafushi was dead in terms of bio-diversity thus the results were questionable.
  - *ME informed that the EIA would be shared once the EIA is finalised. It was mentioned that the EIA and annexes including the studies that is part of the EIA would be made available at the ADB website soon for comments. It would be made available on the*



## C



### Ministry of Environment

Male', Republic of Maldives.

ދިވެހިސަރުކާރުގެ ގެޒެޓް ގައި ބަޔާންކުރި ގޮތުގައި  
މިއަހަރުގެ ފެބްރުއަރީ 2017 ވަނަ އަހަރުގައި

*website for a period of 3 months. EPA would also publish it on their website, once the ME submits the final EIA to EPA.*

#### **Inefficiency and ineffectiveness of ME and EPA**

- Participants raised concern over the ineffectiveness of Ministry of Environment and the Environmental Protection Agency. It was noted that they do not hear back from the organisations in a timely manner for other matters that they have contacted to those institutions. It was also noted that EPA should have the capacity monitor air emission levels from the project.
  - *PM noted that the project would response on any queries regarding this waste project. ME noted that part of the project is to build the capacity of EPA and strengthen institutional capacity to monitor the air pollution emissions. Air pollution emission stations are recommended to be established at Thilafushi to monitor the impacts of stack emission on Thilhafushi.*

#### **Other waste**

- A participant inquired how hazardous waste, medical waste, construction and demolition waste, and end of life vessels would be handled at Thilafushi when this project is completed.
  - *ME noted that all the hospitals and health care facilities are required to have autoclaves to treat the medical waste before it is send to Thilhafushi for treatment and disposal. The proposed facility can manage the hazardous waste in the household. The facility would store any other hazardous waste received. The facility can receive end of life vehicles. ME noted that the facility at Thilhafushi is a municipal solid waste incinerator facility. Government is developing another facility to treat hazardous waste.*

## Terms of Reference

### Greater Male Waste-to-Energy Project

#### Project Management, Design and Construction Supervision (PMDCS) Consultant

<b>A</b>	<b>Background .....</b>	<b>2</b>
<b>B</b>	<b>Objectives of the Assignment .....</b>	<b>3</b>
<b>C</b>	<b>Scope .....</b>	<b>4</b>
<b>D</b>	<b>Responsibilities and Deliverables .....</b>	<b>4</b>
D.1	Project Management.....	4
D.2	Review of the Design of the DBO Contract Components .....	5
D.3	Construction Supervision .....	6
D.4	Commissioning Supervision.....	7
D.5	Environmental and H&S Components.....	8
D.6	Capacity Building of EPA and the Employer’s Personnel .....	9
D.7	Operation Service Period.....	10
D.8	JFJCM Related Project Components .....	11
<b>E</b>	<b>Qualification Requirements for the Key Experts &amp; Team Composition.....</b>	<b>11</b>
<b>F</b>	<b>Reporting Requirements and Time Schedule for Deliverables .....</b>	<b>15</b>
<b>G</b>	<b>Employer’s Input and Counterpart Personnel.....</b>	<b>16</b>
<b>H</b>	<b>Inputs, Project Data and Reports to Facilitate Preparation of the Proposals.....</b>	<b>17</b>
<b>I</b>	<b>Commencement of the Assignment.....</b>	<b>17</b>

## A Background

1. The Greater Malé capital region and its outer islands (classified as Zone 3 in the national solid waste management policy) suffer from severe environmental pollution and deteriorating livability because of inadequate collection and haphazard disposal of solid waste. Zone 3 covers 35 inhabited islands, 73 tourist resorts, 14 city hotels, and 177 guest houses, in the North Ari Atoll (Alifu Alifu Atoll), South Atoll (Alifu Dhaalu Atoll), Malé' Atoll (Kaafu Atoll) and Vaavu Atoll, including the capital city of Malé, with a total population of 216,000 (51% of Maldives). Lack of a sustainable system to manage the 774 tons per day (tpd) of solid waste generated in Zone 3 ( results in waste spillage into the ocean, and open dumping and burning of garbage at the 30-year old 10-hectare dumpsite on Thilafushi Island which has no pollution control measures creating a public health and an environmental hazard.<sup>1</sup> Plumes of smoke visible from the capital Malé, the international airport and nearby resorts compromise air quality and pose nuisance to residents and tourists, while leachate and plastics contaminate the surrounding marine environment.
2. The Government of Maldives is committed to improve the environmental conditions and to strengthen the solid waste management (SWM) system in the country. For Zone 3, the government plans to develop a sustainable regional waste management facility on a newly reclaimed 15 ha land on Thilafushi island adjacent to the current dumpsite. The facility will include a 500 tons per day waste to energy treatment plant (WTE) including a bottom ash processing plant, a landfill for air pollution control (APC) residues and bottom ash including leachate treatment plant. The facility will be developed through a Design-Build-Operate (DBO) Contract (the "Contract") pursuant to the FIDIC Gold Book, with design and build period proposed to be financed by the Asian Development Bank (ADB), Asian Infrastructure Investment Bank, ADB's Japan Fund for Joint Crediting Mechanism, and the government under the Greater Male Waste to Energy Project (the project). The government will cover the cost for the 20 years operation period. The project will mitigate greenhouse emissions and will be registered as joint crediting mechanism.
3. A shortlist of pre-qualified firms was finalized in fourth quarter 2019 and invitations for bids for the DBO contract is expected by December 2019. The DBO Contractor (the "Contractor") will be awarded in the fourth quarter of 2020, with the facility to be commissioned within 3.5 years after the notice to proceed. Included in the scope of the Contractor is design, build and operation of the facility, and also preparation of the permitting application for the construction and operation of the WtE plant. The volume of the design-build (DB) component of the DBO Contract is expected to be around \$120 million.
4. The WTE facility will receive waste that is collected in Zone 3 and transferred to Thilafushi Island. Collection and transfer of solid waste is not part of the Contractor's scope. Besides this waste, a stockpile of baled waste that is generated in the transition phase after closing the dumpsite and the commissioning of the WTE will also be incinerated.

---

<sup>1</sup> The population is expected to grow to 300,000 within the next five years. In 2022 the expected generation of municipal solid waste (MSW) of residents, commercial and industrial entities and institutional bodies is approximately 115,000 tonnes which is complemented by another 70,000 to 100,000 tonnes of construction and demolition waste. Breakdown of solid waste by type: construction and demolition = 530 tpd (68%), household = 149 tpd (19%), resort = 48 tpd (6%), commercial = 27 tpd (3%), airport = 9.3 tpd (1.2%), industrial = 6 tpd (0.8%), market = 2.5 tpd (0.3%), hazardous = 1.5 (0.2%), and end-of-life vehicles = 0.65 tpd (0.1%). Source: Government of Maldives, Ministry of Environment and Energy. 2018. Feasibility Study for an Integrated Solid Waste Management System for Zone III (including Greater Malé) and Preparation of Engineering Design of the Regional Waste Management Facility at Thilafushi. Malé

5. The Ministry of Finance (MOF) is the executing agency while Ministry of the Environment (MOE) is the implementing agency. MOE will own and be in charge of the WTE facility operations. The state-owned Waste Management Company Ltd. (WAMCO) or other contractors will be the supplier of waste to the WTE facility. The Environmental Protection Agency (EPA) is responsible for regulatory activities for waste management and pollution prevention. The State Electricity Company Ltd. (STELCO), Greater Malé Industrial Zone Limited (GMIZL), Ministry of Planning and Infrastructure and Malé City Council are relevant stakeholders.
6. With respect to the FIDIC terminology, MOE will be the Employer.

### **Further information**

7. The Greater Male Waste to Energy Project will complement the ongoing Greater Male Environmental Improvement and Waste Management Project (GWEIWMP), assisted by ADB \$33 million grant. GWEIWMP supports (i) solutions for immediate control of nuisances from Thilafushi Island dumpsite and interim measures to manage the incoming waste until a new treatment facility is commissioned (e.g. baling of municipal solid waste); (ii) development a construction and demolition (C&D) waste treatment plant; (iii) island waste management centers in outer islands; and (iv) installing an appropriate collection and transfer system in Malé and other islands/resorts in Zone 3, including transfer stations in Malé and Villimale, (v) construct a disassembling plant for end-of-life vehicles, (vi) institutional capacity building and public awareness in sustainable SWM and reduce, reuse and recycling.
8. The state-owned Waste Management Company Ltd. (WAMCO) operates the waste collection in Malé, Hulhumale and Villimale and dumps waste on a dumpsite on the island of Thilafushi. On inhabited islands, the islands councils are in charge of collection and basic disposal. WAMCO took over the operational responsibility for waste management in December 2015.
9. The government also plans to i) rehabilitate the existing dumpsite in Thilafushi and ii) develop a transfer station in Hulhumale. The dumpsite rehabilitation invitation for bids is expected in the fourth quarter of 2020 or first quarter 2021. These two components are proposed to be financed on a parallel basis by the Islamic Development Bank.

### **B Objectives of the Assignment**

10. To successfully implement the Greater Male Waste to Energy Project through high quality management, design and construction supervision, the government (executing agency and implementing agency also referred as the Client) will require the support of a professional engineering and management consulting firm ("the Consultant"). The firm will assist in the delivery of the different project components, which include the design, construction and initial operations (including capacity building of EPA and Employer in monitoring operations) of WTE facility and associated landfill of air pollution control residuals and non-marketable incineration bottom ash.
11. The Consultant will act as Employer's Representative (ER, FIDIC Gold Book) during the design and build period and the first two years after the successful commissioning of the WTE plant (operation period).

## C Scope

12. The Consultant's scope evolves from the roles and responsibilities stipulated in the relevant general conditions of the FIDIC Gold Book.
13. The Consultant is expected to provide inputs relating to the conceptual and detailed engineering and design reviews, construction supervision and contract administration, project management and monitoring, cost control, ensure compliance with social, environmental, occupational health and safety aspects, amongst others, provide capacity building support but not limited to the following:
  - i. Ensure that the facilities and the equipment are designed according to the Employer's Requirements that are part of the DBO Contract;
  - ii. Supervise, monitor and control the progress of design and construction of the WtE facility and the ancillary components in sufficient detail by, for example but not limited to, design reviews, inspection of manufacturing and construction sites, site meetings etc., as necessary and stipulated in the relevant contracts;
  - iii. Monitor and manage any occurring interface during the construction activities of the Contractor and the contractor carrying out the dumpsite rehabilitation and minimize their impact on the timeline of the Project;
  - iv. Supervise the construction of the new landfill and validate the bottom liner system construction Quality Assurance/Quality Management;
  - v. Monitor and control the construction activities to minimize their environmental impact;
  - vi. Monitor and control the commissioning and trial run operations including the tests on completion of the design-build period of the WtE plant including all ancillary facilities;
  - vii. Support the Employer during processing of claims and invoices submitted by the contractors;
  - viii. Assure that the contractor complies with relevant ADB safeguard standards;
  - ix. Instruct and train the Employer's and EPA's staff in performance analyses and monitoring related to statutory compliance and to the performance guarantees of the WtE plant and its ancillary facilities;
  - x. Draft a Joint Crediting Mechanism (JCM) methodology and support the Employer in registering the WtE facility for the GHG emission reductions;
  - xi. Support the Employer during the first two years after of operation after issuing the commissioning certificate to monitor and review the performance of the DBO facilities.

## D Responsibilities and Deliverables

14. The overall responsibility to deliver the outputs will rest with the consulting firm through the Team Leader/Project Manager. The Consultant will ensure timely delivery of the documents, establish coordination among all stakeholders and within the team members of the Consultant, scheduling mobilization/demobilization of team members and to interact with the Client on regular basis and as needed.
- D.1 Project Management
15. Project management, control and monitoring responsibilities and tasks the Consultant will assume are as follows:
    - i. Plan and manage the project, and assist the Employer on the project management, including risk management, cost control, scheduling, monitoring, auditing, reporting, and compliance monitoring for the project required under both the government and ADB rules

- and guidelines;
- ii. Review, comment and, if required, approve the Contractor's programs that are to be submitted including all pertinent activities and work packages, analyze critical paths, responsibilities and functions assigned and flag any time and cost over-run if required;
  - iii. Prepare a work programme for each of the Consultant's team members in line with the Contractor's schedule;
  - iv. Establish, coordinate and manage the information exchange between the Consultant, Contractor and the Employer and, as the case may be, other Project stakeholders;
  - v. Attend meetings necessary to manage the Project, prepare minutes and control the outcomes decisions taken;
  - vi. Establish a document control and proper filing system for project offices, including official correspondence, drawings, site instructions, variation orders and site records;
  - vii. Monitor open topics, claims of the Employer towards the Contractor, defects to be rectified, potential malfunctions of equipment etc. and track solutions to be implemented;
  - viii. Review and recommend on the Contractor's claims for progress payments;
  - ix. Review and examine the Contractor's requests for variation orders, extra items, new rates, claims for time extension and extra payment, filed by the contractor etc. and submit recommendations for approval, if appropriate;
  - x. Develop and implement procedures for timely payments to the Contractor and monitor for compliance;
  - xi. Assist constructively and submit recommendations in resolving any potential difficulty or dispute that may arise between the Contractor and the Employer;
  - xii. Prepare essential reports and documents including quick report on progress, quality, disbursement or any other relevant matter as may be required by the Client, Employer or the ADB and other funding institutions;
  - xiii. Assist the Employer in conducting regular meetings with all stakeholders, Contractor, and other government entities, etc., to discuss progress and issues related to implementation, and prepare minutes for recording and circulation;
  - xiv. Establish all necessary records and the procedures of maintaining/updating such records for each package and component of the Project;
  - xv. Assist on liaison with local authorities and government agencies, liaison with ADB and other funding institutions. Assist the Client/Employer in reporting to these institutions;
  - xvi. Review all proposed sub-contractors and verify their insurance, performance bond and collateral warranty or hereto relating parent company guarantees;
  - xvii. Assist the Client in ensuring compliance with all loan covenants during Project implementation and assist in reporting towards the funders.
16. Besides the responsibilities above, the Consultant will work closely with the Employer's project management unit by sharing relevant and requested information.
- D.2 Review of the Design of the DBO Contract Components
17. The Consultant's responsibilities with respect to the design stages will include the review and approval of the proposed designs (submitted by the Contractor) including concept, detailed and works designs.
18. As per DBO Contract, the detailed design will be provided in packages to facilitate an appropriate design progress to develop the WtE facility and the residual waste landfill including permit application within 3.5 years. The Contractor may apply Building Information Modelling (BIM) to facilitate a smooth design and construction.

19. The Consultant's scope will include, but is not limited to, the following:

- i. Review the design program of the Contractor with respect to feasibility, critical paths, achievement of milestones etc.
- ii. Agree with the Contractor on the format and content to be delivered during the design stages, such as concept, detailed and works design, to achieve a timely delivery of the works included in the contract package;
- iii. Assist the Employer in facilitating the Contractor to obtain the permit upon due consultation with the EPA, Ministry of Planning and Infrastructure, and key authorities or stakeholders;
- iv. Agree with the Contractor on a defined conceptual design status in line with the milestones as per contract to limit variations during later design and construction stages;
- v. Review, examine and, if required, approve during the different design stages (concept, detailed, works), drawings, design reports, calculations, technical specifications of equipment and materials etc., in due course as per phasing requirements that are stipulated in the DBO Contract;
- vi. Check the design towards the functional and design criteria and specifications, H&S and environmental aspects, operability matters, flood and storm resilience, product quality and the supply chain to be established;
- vii. Arrange and manage design review meetings in Malé to expedite and to facilitate a smooth design review;
- viii. Monitor the design progress and inform the Employer about any deviations and potential delays;
- ix. Suggest design changes if necessary and advise the Employer on these changes and potential cost and schedule implications by furnishing appropriate reports. In the event costs have to be borne by the Contractor, advise the Employer accordingly;
- x. Review and, if needed, approve the contractor's method statements, site organization arrangements, utilities, shipment plans etc.;
- xi. In the event procurement/manufacturing is carried out during the design stage, inspect or coordinate the inspection of manufacturing of critical components of the WtE plant as per contractual provisions incl. the review of certificates, technical specifications and workmanship;
- xii. Check the hazard and operability (HazOp) analyses and hazard area classification drawings;
- xiii. Review, comment and, as the case may be, approve the plans and documents the Contractor has to submit during the design-build phase, such as, but not limited to, operations and maintenance plan, the Contractor's environmental management plan (CEMP), quality management and assurance plan, the H&S plan, residual waste and landfilling plan, the programme on tests on completion of design-build, etc.; and
- xiv. Ensure disaster- and climate-resilient features are incorporated in the final designs.

D.3 Construction Supervision

20. The Consultant will:

- i. Review method statements, work drawings and construction methodology for their correctness and adequacy prior to the start of works, report findings and propose/recommend modifications or corrections to any defect or omissions and issue for execution; monitor impact and report on physical progress of the works and financial disbursements;

- ii. Maintain sufficient site-based staff, with clear allocation of duties, to monitor, inspect and closely follow up the day-to-day construction activities in line with the timely requirements of the construction works;
- iii. Maintain daily records of execution progress in an appropriate format to be shared with the Employer;
- iv. Co-ordinate with all stakeholders to achieve timely completion of contractual obligations on the part of Contractor and the Employer;
- v. Review any upcoming design changes in the course of the construction and advise the Employer on potential cost and design/construction schedule implications;
- vi. Monitor the Contractors' performances against the stipulated milestones and the agreed project progress, furnish an updated list of open topics and advise the Employer about any expected or unexpected delay and potential cost implications;
- vii. Check the adequacy and quality of the Contractor's input in terms of material, equipment & machinery, personnel and safety arrangements prior to commencement of the works and periodically during the construction activity;
- viii. Inspect and control the executed works and the supplies of equipment to be in compliance with the approved work drawings (design for construction) and with the Employer's Requirements;
- ix. Review, inspect and/or coordinate the review and inspection of manufacturers of major and critical components and their manufacturing sites pursuant to the Contract provisions with respect, but not limited, to certificates evidencing skills and experiences of workers, documented and certified materials used, technical specification of (sub)components embedded, the general workmanship and the final product quality;
- x. Monitor the assembly of components and its progress towards expected milestones;
- xi. Agree with the Contractor on the test programme prior to completion of the design-build, attend the tests, review the test reports and endorse test certificates;
- xii. Review and approve the as-built-documentation and, as the case may be, request changes prior to acceptance;
- xiii. Record and follow up on defects identified during the design-build period and ensure that all defects are remedied within the time stipulated;
- xiv. Scrutinize the quality assurance system and quality control plan of the Contractor, prepare quality compliance and progress reports;
- xv. Support and assist the Employer in Contract administration and compliance with contractual conditions and ADB's Project Administration Manual;
- xvi. Support the Employer during the processing of payment and claims providing any necessary input (such as measurement of works progress, judgement and information concerning milestone achievements, acceptance of variation orders, deduction of retention money);
- xvii. Assist the Employer in forecasting the progress of works and finalization of periodic targets for the expenditure and disbursement.

#### D.4 Commissioning Supervision

21. Responsibilities of the Consultant related to commissioning of the DBO contract components will include:
  - i. Maintain a sufficiently staffed and skilled team to keep up with the responsibilities assigned during the commissioning period including the demonstration of performance guarantees that were defined in the Contract;
  - ii. Support the Contractor, as far as required, to obtain the necessary permits to conduct



- the commissioning activities;
- iii. Assist the Employer in making available the required amount of waste prior to the tests on completion of the design-build;
- iv. Review and approve the Contractor's test programme on the completion of the design-build and agree with the Contractor on a final programme;
- v. Request to commission parts and sections of the works if need be;
- vi. Attend and monitor the commissioning tests (incl. pre-commissioning) and trial operations including the tests on completion of design build to demonstrate the performance requirements, standards and guarantees;
- vii. Furnish commissioning attendance protocols and highlight issues that might affect the scheduled tests on completion of design build;
- viii. Review the test reports on completion of design-build and make necessary comments and adjustments, and, in the event of failure of the tests, request the Contractor to conduct a retest;
- ix. Support the Employer during any claims related to the commissioning period;
- x. After due consultation with the Employer, issue the commissioning certificate upon successful completion of the test on design build;
- xi. Summarize the performance of the facilities being tested and give necessary instructions to the Employer and the EPA relating the performance monitoring and the compliance measurements.

#### D.5 Environmental and H&S Components

##### 22. Responsibilities related to environmental, occupational health and safety are:

- i. assist PMU in meeting requirements of ADB SPS and government on environment, occupational health and safety, and labor standards.
- ii. assist PMU in obtaining all necessary permissions and complying with statutory requirements;
- iii. ensure Contractor submits requirements per EMP and government clearances/permits,
- iv. provide support to Contractor in preparing the Contractor's EMP (CEMP) to ensure ADB SPS and conditions in government clearances are incorporated accordingly;
- v. assist PMU in updating the EIA for any change in scope, design, location, or unanticipated impacts that are not reported in the EIA;
- vi. review any changes in the Contractor's design and support PMU in ensuring environmental assessment, impacts avoidance and mitigation measures are reflected in the CEMP and updated EIA
- vii. assist the Contractor and the PMU in all EPA related clearances, and ADB's no-objection, and monitor and control construction and assembly compliance against the updated EIA, ADB's safeguards policy statement (2009), and CEMP;
- viii. monitor the contractors' compliance with all safety requirements as stated in DBO contract and CEMP, during and prior to any construction activity.
- ix. assist in preparation of accident report and keeping accident records on-site as required;
- x. monitor the implementation of the CEMP during construction and pre/post construction phases;
- xi. assist PMU in continuing stakeholders engagement, consultantations, information disclosure and addressing complaints/grievances;
- xii. develop public awareness program and materials to support wider understanding of

- the project, potential impacts and measures to ensure impacts are avoided, mitigated and affected people, if any, are compensated;
- xiii. assist PMU in preparation of environmental monitoring reports
  - xiv. coordinate with external environmental experts on results of independent monitoring and support PMU to prepare corrective actions, if required
  - xv. provide and organize trainings/workshops/seminars on environmental safeguards, occupational health and safety, and labor standards
  - xvi. assist PMU in review of contractor's health and safety program and in monitoring its implementation
  - xvii. support PMU during ADB review missions
  - xviii. support PMU in developing data management system on environmental safeguards; and
  - xix. other tasks related to environmental safeguards, occupational health and safety, and labor standards

#### D.6 Capacity Building of EPA and the Employer's Personnel

23. Given the limited capacity of both the Employer's and EPA's staff to monitor the facility, the Consultant will provide training for the eligible MOE and EPA staff. The timing of the training activities will be aligned with the construction progress and the visits during the Operation Service Period to provide a firm understanding of the built facilities. The waste supplier's personnel will be included as far as necessary.
24. The Consultant's scope will cover the following aspects:
- i. Prepare a training program for the Employer's and EPA's staff on monitoring the WtE plant and its ancillary facilities with respect to environmental compliance and best operational performance;
  - ii. Conduct induction training for the Employer and EPA amongst others on the following subjects relating the design:
    - a) Technical design and construction characteristics of the WtE plant built and its ancillaries, particularly the furnace, boiler, turbine and APC system, landfill and leachate treatment;
    - b) Continuous emission monitoring systems, its functionality and calibration;
    - c) Access to the Plant Information Management System (PIMS);
  - iii. Instruct the EPA and the Employer's staff on relevant H&S aspects, such as
    - a) Fire hazards, safety, fighting and alarm system;
    - b) Operating highly pressurized vessels;
    - c) Handling chemicals, dust and toxic substances;
  - iv. Detail the operations and maintenance of a WtE plant, amongst others:
    - a) Input control and fueling according to stoker capacity diagram and the hereto relating bottle necks (boiler, turbine, bottom ash quality etc.)
    - b) Bunker management and mixing of waste for a steady state operations;
    - c) Function and malfunction of the CEMS and how to detect those;
    - d) Use of the SCADA (or DCS archives) and the interfaces to SCADA via the PIMS for a constant access of data;
    - e) Necessary down times for inspection, revision or overhaul and typical annual maintenance schedule (incl. expenses) and its consequences towards the waste delivery;

- v. Monitoring the facility is regarded as a primary task of both EPA and the Employer which makes it necessary to enhance the capacity in the following subjects:
    - a) Reporting requirements towards the contractor;
    - b) Scrutinizing regular reports, e.g. by assessing throughput, steam generation and flue gas volume vs. backwards calculated calorific value;
    - c) How to utilize the access to archived SCADA data and to online data via the PIMS;
    - d) Calibration records of essential components (weighbridge, crane scales, CEMS);
    - e) Operational meetings on the facilities performance;
    - f) Solving any potential conflicts prior to arbitration and what to tolerate and where to intervene.
  - vi. Contract management, such as performance guarantees and damages mechanisms, asset replacement fund utilization, milestones, timeframes for payments, dispute resolution etc.;
25. The training will be complemented by appropriate visits of the construction site and the operating plant to facilitate a better understanding of the characteristics of relevant components that are of a particular importance for EPA and the Employer (such as the continuous emission monitoring system, the APC system, the residue handling etc.).

#### D.7 Operation Service Period

26. The Consultant will be responsible within the first two years after issuing the commissioning certificate of the WTE facilities and components to assist the Employer to monitor and control the Contractor's performance amongst others in the following areas:
- i. Follow up on a timely remediation of defects after issuing of the commissioning certificate and scrutinize the Contractor's final claim for reimbursement of the retention money as per DBO contract provisions;
  - ii. Assist the Employer in inspecting the facilities and reviewing their performance using the relevant data as per SCADA records or any other records to be made available by the Contractor with respect to
    - a) the waste delivery (quality and quantity) and performance of WAMCO's C&D waste processing unit,
    - b) the compliance to statutory requirements,
    - c) the performance parameters and guarantees as per DBO contract,
    - d) the production and quality of bottom ash and prospects of the bottom ash marketing;
    - e) the production and contract compliant landfilling of APC residues;
    - f) the consumption of supplies;
    - g) scheduled down-times of the facility;
    - h) the envisaged and applied maintenance;
  - iii. Suggest appropriate measures (e.g. within the DBO contract) in the event the Contractor fails to meet performance standards/guarantees;
  - iv. Advise the Employer of any issues identified during visits and suggest rectifications;
  - v. Prepare reports on each inspection visit;
  - vi. Upon reasonable request by the Employer, assist in solving occurring contractual issues arising out of the operations.

27. The responsibility of the Consultant will include two visits per year of appropriate staff of a duration of at least two weeks each to accommodate both the inspection and the training needs as per section D.6.

#### D.8 JFJCM Related Project Components

28. To apply for the Joint Crediting Mechanism (JCM), MoE will define the JCM methodology and prepare a project design document, and monitoring methodology that will be submitted for final approval and registration with the JCM. The Consultant will collaborate closely with MoE and take into consideration the requirements as defined in Annex 1. To obtain the approval, the Consultant will:
- i. Draft JCM methodology for the proposed WtE and assist the project management unit (PMU) to have the methodology approved;
  - ii. Draft a project design document for the proposed JCM project, assist PMU to have the project design document validated, and have the project registered;
  - iii. Conduct a local stakeholder consultation (LSC) as required for the JCM process.
  - iv. Conduct a capacity building of the PMU to meet the requirement for the JFJCM including monitoring of GHG emission reductions, drafting a monitoring report, having the monitoring report verified, and requesting issuance of JCM credits;
  - v. Assist PMU to conduct monitoring and draft monitoring report, have the monitoring report verified, and request issuance of JCM credits;
  - vi. Train PMU staff in carrying out the JCM monitoring, reporting and verification process.

### E Qualification Requirements for the Key Experts & Team Composition

29. **Expected qualification requirements and tasks assigned to the Key Experts:** The Consultant will provide experts to cover all aspects of the facilities as per the contractual agreements either being concluded already or to be tendered (e.g. fire engineering expertise). Because of the nature of a WtE facility, several experts may be required for the one or other field of expertise. It will be within the Consultant's discretion to name as many experts as deemed necessary to cover all elements of the WtE plant and its ancillaries that are subject of this DBO contract. The team composition and minimum requirements are as follow.
30. **Team Composition with estimated Input:** The Consultant team will comprise of International Key-experts (87 person-months), National Key-experts (76 person-months), and non-key experts (33 person-months) excluding those required for Consultant's administrative, clerical and support staff. The Consulting firm will be engaged for 5 years to cover 3.5 years for the DBO design-build and the first two years of the operation service period. The expert's positions with their estimated inputs are provided in Table 2 below.

#### Table 2: Team Composition

<b>I International Key Experts</b>		<b>Person Months</b>
1	Team Leader cum WtE Expert	22
2	Financial/Commercial Expert	1.5
3	Site Engineer(s)	32
4	Civil Engineering Experts (infrastructure/structural)	6
5	Process/Mechanical Engineering Experts	7
6	Electrical Engineering Expert	3
7	Instrumentation and Control Engineering Expert	3
8	Environmental Safeguard Expert	6
9	JCM Expert	6
<b>International Key Experts Sub-Total</b>		<b>87</b>
<b>II National Key Experts</b>		
1	Deputy Team Leader/Construction Management Expert	34
2	Financial/Commercial Expert	6
3	Contract Management Expert	6
4	Civil/Structural Engineering Experts	10
5	Mechanical Engineering Experts	7
6	Electrical Engineering Expert	7
7	Environmental Expert	6
<b>National Key Experts Sub-Total</b>		<b>76</b>
<b>III Non-Key Experts</b>		
1	Assistant site engineers (international)	12
2	Other international experts (fire/building service engineers etc.)	6
3	Assistant site engineers (national)	15
<b>Non Key Experts Subtotal</b>		<b>33</b>
<b>Overall total</b>		<b>196</b>

31. **Team Leader cum Waste-to-Energy Expert (International):** The Team Leader cum WtE Expert will be responsible for overall project management and administration, construction supervision, quality control and monitoring, contract management, establishment of construction management and project performance monitoring and reporting system, assist in resolving contractual issues, preparation of progress and other reports as required. Jointly with the team, the Team Leader will fulfill the role of Employer's Representative. The Team Leader cum WtE Expert (International) will preferably i) be graduate mechanical/civil/environmental engineer and post graduate in project management or contract management with a certificate like or similar to PMP®, ii) have at least 15 years of working experience in WtE works of similar complexity and volume (400 tpd or higher, USD 50 million or higher), iii) experience and sound knowledge of FIDIC contract conditions and DBO contract management, and iv) knowledge and experiences in the application of building information modelling (BIM), and experience with international financial institutions (IFI) funded projects will have added advantage.
32. **Financial Expert (International):** The Financial Expert will support the Employer in financial management issues. He/she will work closely and supervise with the Employer in all matters related to the subject. Financial Expert (International) will preferably i) be a post graduate in economics or finance, ii) have at least 15 years of experience in carrying out economic and financial analysis of large (preferably similar) projects, and iii) good knowledge of ADB or other IFIs procedures/policies, and experience in WtE projects will have added advantage.
33. **Site Engineer(s) (International):** The Site Engineer(s) will be the point of contact towards the Contractor and the Employer for all construction related aspects and issues. He/she will

manage all day-to-day activities with the support of the national Deputy Team Leader and specialist construction and assembly supervisors (non-key assistant site engineers, both international and national) as required. He/she will be i) either a technician or a graduate engineer in mechanics/civil engineering with a post-graduate in construction management, ii) have at least 15 years of experience in similar projects and will be familiar with supervising and monitoring a WtE plant's construction site, iii) preferably will have knowledge of FIDIC Gold Book or similar DBO contract packages.

34. **Civil Engineering Experts (International):** Civil Engineering Experts will be responsible for the review and approval of civil engineering designs/drawings/details submitted by the Contractor. They will assist in monitoring and ensure quality assurance and control. Civil Engineering Experts (International) will preferably i) be graduates in civil engineering, and, as required per, expertise with post graduates in structural engineering, geotechnics, landfill engineering etc. ii) have 10 years of experience in the relevant design and design review in similar work environments, iii) be versed in the application of relevant CAD tools, iv) construction supervision, design and implementation related to similar works in low-lying land, knowledge of BIM and related tools will have added advantage.
35. **Process or Mechanical Engineering Experts (International):** Process or Mechanical Engineering Experts will be responsible for review of design, drawings and data, technical specifications and P&IDs prepared by the Contractor, ensure quality assurance and quality control. They will assist in resolving technical and contractual issues. Process or Mechanical Engineering Experts (International) will preferably be i) post graduates in process/mechanical engineering, ii) have 10 years of experience in process or mechanical engineering related to WtE facilities such as, but not limited to, cranes, furnace, boiler, turbine and water steam system, APC system etc., iii) be familiar with the application of relevant process engineering and CAD applications, and iv) construction supervision and implementation of works related to WtE facilities and knowledge of BIM will be regarded as advantage.
36. **Electrical Engineering Expert (International):** Electrical Engineering Expert will be responsible for review and approval of designs, drawings, specifications and data, ensure quality assurance and quality control, assist in resolving technical and contractual issues. Electrical Engineering Expert (International) will preferably i) post-graduate in electrical engineering, ii) have 10 years of experience in electrical engineering designs of similar projects, 5 years thereof in the WtE field, and iii) construction supervision and implementation of works related to WtE plants will have added advantage.
37. **Instrumentation and Control Engineering Expert (International):** Instrumentation and Control Engineering Expert will be responsible for review and approval of lay-out, design, drawings, data related to SCADA/DCS, ensure quality assurance and quality control of SCADA/DCS design and implementation, assist in resolving technical and contractual issues. Instrumentation and Control Engineering Expert (International) will preferably i) hold a post-graduate in instrumentation & control engineering, ii) have 10 years of experience in instrumentation and control engineering design and implementation, 5 years thereof in the field of WtE facilities, iii) be versed in the application of relevant process engineering and CAD applications, and iv) experience in construction supervision in the WtE field will be regarded as advantage.
38. **Environmental Safeguard Expert (International):** Environmental Expert will be responsible for management and supervision of environmental safeguard requirements in line with the

Contract, EIA including ADB SPS (2009) and the Government of Maldives. Among the responsibilities will be the preparation and implementation of environmental safeguard action plan, review of the (updated) EIA report, monitor the implementation of the CEMP. Environmental Safeguard Expert (International) will preferably i) be graduate in civil engineering, environmental science, structural engineering, environmental management or related field. Post graduate degree related to the field will be an advantage; ii) have 10 years of experience in preparing, and/or carrying out EIA/IEE/EMP, 5 thereof in WtE facilities-related projects, and iii) good knowledge of ADB or other IFI safeguards policies, design and construction with respect to implementation of environmental safeguards will have added advantage.

39. **JCM Expert (international):** The expert will have experience in carbon offset mechanisms and knowledgeable in rules on the Joint Crediting Mechanism (JCM). The expert will have a bachelor's degree in science, environment, or engineering; with 10 years of post-qualifying experience; have worked in at least two JCM or similar activities, to develop documents, prepare trial calculations and measurement systems, to establish the emission reductions accrued. The consultant will have experience in developing methodologies that have been approved under the JCM scheme preferably. Knowledge and experience of waste to energy system are assets. The qualification will be verified by JFJCM Secretariat of the ADB.
40. **Deputy Team Leader Cum Construction Management Expert (National):** Deputy Team leader cum Construction Management Expert will assist the international team leader, will support in overall project management and administration, construction supervision (jointly with the international site engineer(s)), quality control and monitoring, contract management, establishment of construction management and project performance monitoring and reporting system, assist in resolving contractual issue, preparation of progress and other reports as required. Deputy Team Leader cum Construction Management Expert (National) will preferably i) be graduate mechanical or civil engineer and post graduate in engineering or management, ii) have 10 years of working experience in leading and managing construction and/or turn-key projects and iii) sound knowledge of FIDIC contract conditions and contract management will be preferred. Experience in externally funded projects will have added advantage.
41. **Contract Management Expert (National):** Contract Management Expert will support the management and administration of the Project effected by the Team Leader and Deputy Team Leader. He/she will assist in establishment of the contract management and reporting system. He/she will elaborate an adequate documentation on contract administration, time & cost control, variations and change orders, billing & payments to the contractors. He/she will be responsible for documentation to ensure adequate progress of works, control the project and minimize the cost over-run and time over-run, timely review and disposal of contractor's claims. Will assist in resolving contractual issue and dispute resolutions during implementation. Contract Management Expert (National) will preferably i) be graduate in process, mechanical, or civil engineering and post graduated in contract management, ii) have 10 years of experience in contract administration related to procurement of Works and Goods for urban infrastructure projects, and iii) sound knowledge of FIDIC contract conditions and experience with IFIs will be regarded as advantage.
42. **Civil/Structural Engineering Experts (National):** Civil/Structural Engineering Experts (National) will assist the international Civil Engineering Experts in the review of the design of all civil/structural engineering elements as required and as submitted by the Contractor. Civil/Structural Engineering Experts (National) will preferably i) be graduate civil engineers,

and will be post-graduated in structural, geotechnical, building services engineering, ii) have 7 years of experience in civil/structural, geotechnical and building services engineering , iii) be versed in the application of relevant CAD tools, and iv) construction supervision, design and implementation related to similar works. Experience in externally funded projects will have added advantage.

43. **Mechanical Engineering Expert (National):** Mechanical Engineering Expert will assist the international Process/Mechanical Engineering Experts in the review of the design of all process and balance of plant related documents and drawings and P&ID as required and submitted by the Contractor. Mechanical Engineering Expert (National) will preferably i) be post graduated mechanical engineer, ii) have 10 years of experience in mechanical designs and implementation of goods and plants in multi-lot projects, iii) be versed in the application of relevant CAD tools, and iv) construction supervision of similar works will be preferred. Experience in externally funded projects will have added advantage.
44. **Electrical Engineering Expert (National):** Electrical Engineering Expert will be responsible for review and approval of designs/drawings/details as submitted by the Contractor, for the quality assurance and quality control and resolving contractual issued related to his/her field of expertise. The Electrical Engineering Expert (national) will assist the international expert in reviewing the electrical engineering design and the documentation, drawings and specifications submitted by the Contractor. Electrical Engineering Expert (National) will preferably i) be a graduate electrical engineer, preferably post graduate in control engineering, ii) have 10 years of experience in electrical design and implementation in multi-lot projects, iii) be versed in the application of relevant CAD tools, and iv) construction supervision of similar works will be preferred.
45. **Environmental Safeguard Expert (National):** The national Environmental Safeguard Expert will support the PMU and the international Environmental Safeguard Expert in the overall management and implementation of environmental safeguard policies of ADB and the Government of Maldives. Environmental Safeguard Expert (National) will preferably i) be graduate in civil engineering, structural engineering, environmental engineering, environmental management, environmental science or related field. ii) have minimum of 5 years work experience on monitoring/supervision capacity, and iii) sound knowledge of ADB procedures and policies, design and construction supervision, design and implementation of similar works will be preferred.
46. **Non-key experts and supporting staff:** The Consultant is expected to deploy non-key experts having qualifications and experience as necessary to deliver the project, such as, but not limited to:
- i. International engineers to support the design review, to attend the factory acceptance testing, the commissioning procedures etc. of the DBO contract's scope;
  - ii. National and international site engineers;
  - iii. CAD operators and office support staff.

## **F Reporting Requirements and Time Schedule for Deliverables**

47. **Reporting Requirements:** During the performance of the services, the Consultant will prepare required reports for submission to the Employer/Client in electronic form and/or hard copies as per Employer's instructions and in English language. The report format will be consistent with the requirements of ADB and Government of Maldives and will be proposed by the



Consultant in its inception report. The reporting formats will be subject to amended time-to-time in consultation with the Client. As a minimum the Consultant will submit following reports at periods stated in Table 3 hereunder.

**Table 3: Reporting Requirements**

<b>Reports</b>	<b>Number of Copies</b>	<b>Time Schedule</b>
Inception Report	Electronic copy only	Within a period of 30 days from the date of issuance of Notice to Proceed.
Monthly Progress Reports	Electronic copy only	Every month within 5 days of the commencement of next calendar month.
Quarterly Progress Reports	Electronic copy only	Every quarter within 10 days of commencement of next quarter.
Annual Progress Report	Electronic copy and 3 hard copies	Every year within 15 days of commencement of next year. For the purpose of Annual Progress Report the year will mean and refer either to Calendar year or other suitable period as the Client may decide in consultation with the Consultant.
Draft Completion Report	Electronic copy and 3 hard copies	Within 30 days of completion of Consulting Services Assignment.
Final Completion Report	Electronic copy and 3 hard copies	Within 30 days of issuance of Client's comments on Draft Completion Report.
Training programme for the capacity building	Electronic copy	At least 30 days prior to the commencement of the first training session
Any other reports	As required	As and when required by the Client.

## **G Employer's Input and Counterpart Personnel**

48. Services, facilities and property will be provided by the Employer: Office accommodation with power and water supply for office establishment on site and in Malé.
49. Professional and support counterpart personnel will provided by the Employer.

## **H Inputs, Project Data and Reports to Facilitate Preparation of the Proposals**

50. The Consultant will have access to the following inputs, project data and reports available with Client to facilitate preparation of the Proposals:
  - a) Data, reports, maps etc. as available with the Employer;
  - b) Feasibility reports, design reports and drawings as available with the Employer.
51. Any other input the Consultant deems necessary and the Employer is able to share will be provided upon request by the Consultant.

## **I Commencement of the Assignment**

52. It is envisaged that the assignment will start three months prior to awarding the DBO contract (pls. refer to clause **Error! Reference source not found.**) to allow the Consultant to familiarize with the Contract.

**ANNEX 1: REQUIREMENTS FOR EXECUTING AND IMPLEMENTING AGENCIES OF THE JAPAN FUND FOR THE JOINT CREDITING MECHANISM (JFJCM) GRANTS**

1. The Ministry of Environment (MOE) will be responsible for developing a Waste to Energy plant project in Thilafushi under Greater Male Waste to Energy Project in the Maldives as a joint crediting mechanism (JCM) projects, and for fulfilling requirements as the project participant of the JCM project.
2. MOE will develop the JCM methodology and submit it to the JCM Joint Committee (JC) for approval. In case the methodology is not approved, MOE will revise the methodology and make best efforts to have it approved by the JC. Methodology approval is to be achieved before JCM project registration.
3. Upon methodology approval, MOE will prepare a project design document (PDD), hire an accredited third-party entity (TPE) to validate the project, and submit the project for registration to the JC. In case the project is not registered, the MOE will make necessary revisions to the PDD considering comments received and make best efforts to have the project registered. Project registration is to be achieved before commissioning of the project supported under the JFJCM.
4. MOE will monitor the project in line with the PDD and prepare a monitoring report at least once a year, based on the recorded monitoring data. The monitoring report will be reported to ADB. MOE will monitor the JCM project from commissioning until the end of the project operation or the expiry of the JCM bilateral document between the Maldives and Japan, whichever is earlier.
8. The Waste to Energy project supported under the JFJCM cannot apply for any other international carbon market mechanisms.

**GREATER MALÉ ENVIRONMENTAL IMPROVEMENT AND WASTE MANAGEMENT  
PROJECT  
PHASE TWO: WASTE TO ENERGY (WTE) PLANT**

**Draft Terms of Reference for an Independent Environmental Monitor (IEM)  
(Subject to Finalization)**

**I. BACKGROUND**

1. The Government of the Maldives is commissioning a design, build and operate (DBO) Contract for a Waste-to-Energy (WTE) Facility Project for the Greater Malé region to help in managing solid waste. The WTE Facility Project will be set up on the island of Thilafushi, Kaafu Atoll in the Greater Malé area. The project will be funded by the Asian Development Bank (ADB) and Asian Infrastructure Investment Bank (AIIB).

2. A concept design for the WTE Facility Project has been prepared by an engineering firm commissioned by the Maldives Ministry of Environment (ME). According to the concept design, the initial capacity of the facility shall be 167,000 Mg/y (two trains 250 tons per day or 10.5 tons per hour each), which then can be extended by a third train. Baled waste will be used as buffer to accommodate any waste volume fluctuations.

3. In relation to environmental management, the project is classified as Category A project per ADB Safeguard Policy Statement (SPS). The Category A classification derives from the project's likely significant adverse environmental impacts to air and marine environment that are irreversible, diverse, or unprecedented. Such classification requires the need of an independent external monitor or IEM.

4. The IEM shall be retained as an international expert under the WTE Facility Project with non-objection from ADB, and will report directly to ADB. The IEM shall not be involved in the day-to-day project implementation or supervision of the project. The IEM will closely coordinate his/her site visits and work with the project management unit (PMU).

**II. PURPOSE.**

5. An environmental impact assessment (EIA) report has been prepared for the project. The EIA contains an environmental management plan (EMP) developed to address the potential impacts and risks identified by the environmental assessment. The EMP includes the proposed mitigation measures, environmental monitoring and reporting requirements, emergency response procedures, related institutional or organizational arrangements, capacity development and training measures, implementation schedule, cost estimates, and performance indicators. This will be updated by the DBO Contractor based on the final detailed design, including the construction methods and materials to be used. The IEM will monitor compliance of the project in implementing the EMP.

**III. DURATION**

6. The engagement of the IEM shall commence on the Commencement Date of the DBO contract and end at the conclusion of the defects notification period following Commissioning of the plant. This duration is expected to be sixty (60) months. The engagement of the IEM may be

extended and should this be the case, notification of such an extension will be provided at least six (6) months before the expected date of the Commissioning Certificate.

7. The work will involve an initial visit of two months prior to or during the DBO Contractor mobilization, and every six months visits thereafter. Home office time will be allocated to report preparation and handling comments and questions from reviewers.

#### **IV. QUALIFICATIONS**

8. The IEM shall have the following qualifications:

- (i) Degree in engineering, chemistry, environmental management or a related field. Masters or doctorate degree will be preferable.
- (ii) Has extensive experience with day-to-day management and/or monitoring of incineration plants of municipal solid wastes, or other facilities involving incineration, and reporting of regular monitoring against the relevant emissions standards.
- (iii) Prior experience on monitoring ADB-funded projects is preferable.

#### **V. DUTIES**

9. The IEM shall have the following duties:

- (i) Become familiar with the project, including the EIA report and implementation arrangements for the project.
- (ii) Contribute to the review of the updated EMP following the final detailed design, and provide comments and recommendations as necessary relating to (i) the adequacy of monitoring arrangements, (ii) the construction work method statements and (iii) the proposed mitigation measures to address newly identified negative environmental impacts and risks.
- (iii) Review monthly environmental monitoring reports submitted by the Contractor to the project management unit (PMU) and quarterly environmental monitoring reports of PMU to ADB.
- (iv) Inspect the project construction works and following construction, plant operations (depending on final arrangements in the future) every six months, assess the environmental impacts of the project based on the EMP and any other critical issues that may arise, and prepare a report on the findings.
- (v) Recommend improvements to effectively implement the EMP and provide professional opinion on the degree of impacts, if any.
- (vi) When on site, comply with all health, safety and welfare requirements, and participate in project meetings as required.
- (vii) Submit all findings and reports directly to ADB.

#### **VI. INDICATIVE COST**

<b>Cost Item</b>	<b>Description</b>	<b>Unit Cost (US\$)</b>	<b>Total (US\$)</b>
A. Remuneration	Retention of international consultant for 77 equivalent days <sup>1</sup>	1,000.00	77,000.00
B. International Travel	11 international travels <sup>2</sup>	5,000.00	55,000.00
C. Per diem	Field work in Maldives for total of 55 days <sup>3</sup>	288.00.	15,840.00

<b>Cost Item</b>	<b>Description</b>	<b>Unit Cost (US\$)</b>	<b>Total (US\$)</b>
D. Miscellaneous Travel Expenses	Lump sum per international travel <sup>4</sup>	150.00	1,650.00
E. Contingency	5% of total cost		7,474.50
<b>Grand Total</b>			<b>156,964.50</b>

<sup>1</sup> (5 field working days + 2 home office days) for each monitoring activity

<sup>2</sup> 1 international travel prior to DBO Contractor mobilization plus 10 international travels for the next 5 years

<sup>3</sup> average of 5 field working days per monitoring activity

<sup>4</sup> lump sum of \$150 per international travel

# SAMPLE Quarterly Environmental Monitoring Report Template

## 1. INTRODUCTION

- Overall project description and objectives
- Environmental category as per ADB Safeguard Policy Statement, 2009
- Environmental category per national laws and regulations
- Project Safeguards Team

Name	Designation/Office	Email Address	Contact Number	Roles
1. PMU				
2. Consultants				

- Overall project progress and status
- Description and status of implementation (preliminary, detailed design, on-going construction, completed, and/or O&M stage)

Components/List of Works	Contract Status (specify if under bidding or contract awarded)	Status of Implementation (Preliminary Design/Detailed Design/On-going Construction/Completed/O&M) <sup>1</sup>	If On-going Construction	
			%Physical Progress	Expected Completion Date

<sup>1</sup> If on-going construction, include %physical progress and expected date of completion

**2. COMPLIANCE STATUS WITH NATIONAL/STATE/LOCAL STATUTORY ENVIRONMENTAL REQUIREMENTS<sup>2</sup>**

Statutory Environmental Requirements <sup>3</sup>	Status of Compliance <sup>4</sup>	Validity if obtained	Action Required	Specific Conditions that will require environmental monitoring as per Environment Clearance, Consent/Permit to Establish <sup>5</sup>

**3. COMPLIANCE STATUS WITH ENVIRONMENTAL LOAN COVENANTS**

No. (List schedule and paragraph number of Loan Agreement)	Covenant	Status of Compliance	Action Required

**4. COMPLIANCE STATUS WITH THE ENVIRONMENTAL MANAGEMENT PLAN (REFER TO EMP TABLES IN APPROVED EIA REPORT)**

- Confirm submission of Contractor’s EMP (CEMP) by DBO Contractor.

**EIA Documentation Status**

DBO Contract Number	Final EIA Report based on Detailed Design				CEMP approved by Project Director? (Yes/No)	Remarks
	Not yet due (detailed design not yet completed)	Submitted to ADB (Provide Date of Submission)	Disclosed on project website (Provide Link)	Final EIA report provided to DBO Contractor (Yes/No)		

- For the DBO Contractor, provide name/s and contact details of contractor’s EHS Manager and trained engineers on EHS, EMP and CEMP implementation.

<sup>2</sup> All statutory clearance/s, no-objection certificates, permit/s, etc. should be obtained prior to award of contract/s. Attach as appendix all clearance obtained during the reporting period. If already reported, specify in the “remarks” column.

<sup>3</sup> Specify (environmental clearance? Permit/consent to establish? Etc.)

<sup>4</sup> Specify if obtained, submitted and awaiting approval, application not yet submitted

<sup>5</sup> Example: Environmental Clearance requires ambient air quality monitoring, etc.



### DBO Contractor's Focal Persons for Environmental Safeguards

DBO Contract Number and Project Name	DBO Contractor	Focal Persons (EHS Manager / Trained Engineers)	Email Address	Contact Number

- With reference to approved EMP/CEMP, complete the table below

### Summary of Environmental Monitoring Activities (for the Reporting Period)<sup>6</sup>

Impacts (List from EIA Report)	Mitigation Measures (List from EIA Report)	Parameters Monitored (As a minimum those identified in the EIA Report should be monitored)	Method of Monitoring	Location of Monitoring	Date of Monitoring Conducted	Name of Person Who Conducted the Monitoring
<b>Design Phase</b>						
<b>Pre-Construction Phase</b>						
<b>Construction Phase</b>						
<b>Operational Phase</b>						

<sup>6</sup> Attach Laboratory Results and Sampling Map/Locations

### Overall Compliance with EMP/ CEMP

No.	DBO Contract Number and Project Name	EMP/ CEMP Part of Contract Documents (Y/N)	CEMP/ EMP Being Implemented (Y/N)	Status of Implementation (Excellent/ Satisfactory/ Partially Satisfactory/ Below Satisfactory)	Action Proposed and Additional Measures Required

#### 5. APPROACH AND METHODOLOGY FOR ENVIRONMENTAL MONITORING OF THE PROJECT

- Briefly describe the approach and methodology used for environmental monitoring of the project.

#### 6. MONITORING OF ENVIRONMENTAL IMPACTS ON PROJECT SURROUNDINGS (AMBIENT AIR, WATER QUALITY AND NOISE LEVELS)

- Discuss the general condition of surroundings at the project site, with consideration of the following, whichever are applicable:
  - Confirm if any dust was noted to escape the site boundaries and identify dust suppression techniques followed for site/s.
  - Identify if muddy water is escaping site boundaries or if muddy tracks are seen on adjacent roads.
  - Identify type of erosion and sediment control measures installed on site/s, condition of erosion and sediment control measures including if these are intact following heavy rain;
  - Identify designated areas for concrete works, chemical storage, construction materials, and refueling. Attach photographs of each area in the Appendix.
  - Confirm spill kits on site and site procedure for handling emergencies.
  - Identify any chemical stored on site and provide information on storage condition. Attach photograph.
  - Describe management of stockpiles (construction materials, excavated soils, spoils, etc.). Provide photographs.
  - Describe management of solid and liquid wastes on-site (quantity generated, transport, storage and disposal). Provide photographs.
  - Provide information on barricades, signages, and on-site boards. Provide photographs in the Appendix.
  - Indicate if there are any activities being undertaken out of working hours and how that is being managed.
- Briefly discuss the basis for environmental parameters monitoring.
- Indicate type of environmental parameters to be monitored and identify the location.
- Indicate the method of monitoring and equipment used.
- Provide monitoring results and an analysis of results in relation to baseline data and statutory requirements.

As a minimum the results should be presented as per the tables below. Complete parameters should follow the recommendations in the EIA report.

### Air Quality Results

Site No.	Date of Testing	Site Location	Parameters (Recommendations of the EIA)				
			PM10 µg/m3	PM2.5 µg/m3	SO2 µg/m3	NO2 µg/m3	Hg µg/m3

### Marine Water Quality Results

Site No.	Date of Sampling	Site Location	Parameters (Recommendations of the EIA)					
			pH	Conductivity µS/cm	BOD mg/L	TSS mg/L	TN mg/L	TP mg/L

### Noise Quality Results

Site No.	Date of Testing	Site Location	LA <sub>eq</sub> (dBA) (WHO Standards)	
			Day Time	Night Time

## 7. GRIEVANCE REDRESS MECHANISM

- Provide information on establishment of grievance redress mechanism and capacity of grievance redress committee to address project-related issues/complaints. Include as appendix Notification of the GRM.

## 8. COMPLAINTS RECEIVED DURING THE REPORTING PERIOD

- Provide information on number, nature, and resolution of complaints received during reporting period. Attach records as per GRM in the approved EIA report. Identify safeguards team member/s involved in the GRM process. Attach minutes of meetings (ensure English translation is provided).

## 9. SUMMARY OF KEY ISSUES AND REMEDIAL ACTIONS

- Summary of follow up time-bound actions to be taken within a set timeframe.

## 10. APPENDIXES

- Photos
- Summary of consultations
- Copies of environmental clearances and permits
- Sample of environmental site inspection report
- all supporting documents including **signed** monthly environmental site inspection reports prepared by consultants and/or contractors
- Others

## SAMPLE ENVIRONMENTAL SITE INSPECTION REPORT

Project Name \_\_\_\_\_  
 Contract Number \_\_\_\_\_

NAME: \_\_\_\_\_ DATE: \_\_\_\_\_  
 TITLE: \_\_\_\_\_  
 LOCATION: \_\_\_\_\_

WEATHER CONDITION: \_\_\_\_\_

INITIAL SITE CONDITION: \_\_\_\_\_

CONCLUDING SITE CONDITION:  
 Satisfactory \_\_\_\_\_ Unsatisfactory \_\_\_\_\_ Incident \_\_\_\_\_ Resolved \_\_\_\_\_ Unresolved \_\_\_\_\_

INCIDENT:  
 Nature of incident: \_\_\_\_\_

Intervention Steps: \_\_\_\_\_

Incident Issues

Resolution

Project Activity Stage	Survey	
	Design	
	Implementation	
	Pre-Commissioning	
	Guarantee Period	

### Inspection

Emissions	Waste Minimization			
Air Quality	Reuse and Recycling			
Noise pollution	Dust and Litter Control			
Hazardous Substances	Trees and Vegetation			
Site Restored to Original Condition	Yes		No	

Signature \_\_\_\_\_

### Sign off

\_\_\_\_\_  
**Name**  
**Position**

\_\_\_\_\_  
**Name**  
**Position**

# PEMPHIS

48



Environmental Newsletter  
Ministry of Environment and Energy



# INVASIVE ALIEN SPECIES



## Editor's Note

In this edition, Pemphis undertakes to highlight the obscure but important issue of Invasive Alien Species (IAS). We have always been concerned about our heritage, tradition and culture by our ancestors; but have we pondered about the identities and traits of our ecosystem?

The set of species inhabited in Maldives living in harmony and equilibrium over the generations are now challenged with **Invasive Alien Species**, since some species introduced to the Maldives have the ability to survive, reproduce and compete with native species.

The impacts does not confine to detriments to the ecosystem alone but is associated with illegal issues of trafficking of wildlife, drugs, and business fraud as well.

Pemphis greatly acknowledges the time and contribution provided by Maldives Customs Service for this edition. Senior Superintendent of Customs, Hussein Hameed shared some valuable insights and concerns regarding the issue of Invasive Alien Species and its associated problems.

Hope you all would find out more on " Invasive Alien Species" and its associated concerns from this month's issue.

Wish you all a safe and blessed days ahead.

Feedbacks, comments, articles, photos, etc.  
[environment@environment.gov.mv](mailto:environment@environment.gov.mv)

"Invasive species are a major threat to biodiversity. Given the way they quickly become established and spread, measures taken by one Member State can have no effect if neighbouring countries fail to take action or respond in an uncoordinated manner. The ecological, economic and social consequences of the spread of invasive species for the EU countries are serious and need a harmonised response." EU Environment Commissioner Stavros Dimas



Ministry of Environment and Energy organized a stakeholder consultation meeting on invasive alien species on the 8<sup>th</sup> of this month. Participants which include government ministries and enforcement agencies expressed their concern over the issue. To conclude the meeting Director General of Environment Ministry Mr. Mohamed Zahir remarked upon the importance of putting a cooperative effort in addressing the issue.

# Invasive Alien Species

"Invasive alien species (IAS) are species whose introduction and/or spread outside their natural past or present distribution threatens biological diversity." Convention on Biological Diversity

## Basic Rule: Arrive, Survive & Thrive

For an alien species to become invasive, its introduced habitat should complement its survivability and reproducibility. However, it must also out-compete the native organisms and spread through and increase its population in its new environment. The local ecosystem can be subjected to negative impacts since this causes disruptions and alterations in the food chain and other associated biological features.

## Common Characteristics of IAS

Rapid reproduction and growth

High dispersal ability

Phenotypic Plasticity (Phenotypic Plasticity: ability to adapt physiologically to new conditions)

Ability to survive on various food types and environmental conditions.

## Giant African Snail *Achatina fulica*



Hussein Niyaz

The Giant African snail, *Achatina fulica*, or locally referred to as "Finihaka" is said to make its mark in the Maldives in the 1960s. Upon the introduction, its population is known to increase dramatically. It is considered as a garden pest but with it can reproduce to such numbers to cause public nuisance. The Giant African snail can alter the habitat properties by feeding on the native plants. Furthermore it is known to out-compete the native snail population as well. It can also act as a vector of human pathogens and parasites.

## Coconut Hispid Beetle *Brontispa longissima*



Ento. Coconut/Flickr

Coconut Hispid Beetle, (*Brontispa longissima*) distresses seedlings, mature coconut trees and other palms, specifically palms up to five years old are at the greatest risk of infestation.

The beetle is known to attack the closed young fronds of the palm. As the spear unfurls the beetle moves on to other palms or the next emerging spear. Coconut hispid beetle invasion can kill the underlying tissue and reduce the leaf photosynthesis of the leaflets. Infestations may result in the complete defoliation of the palm and in worst cases palms can die.

The beetle was introduced to the Maldives in the late 1990s from ornamental palms imported from Malaysia and Indonesia. It is believed that these originated from adult or immature stages of the pest that were concealed in these palms. Even with the fragmented and isolated geography of the nation the beetle had spread to several islands in a year's period. A severely affected resort of Maldives has reported to have incurred direct economic loss of over US\$ 200,000 within a period of 3 years.

# Impacts of Invasive Alien Species

Predicting the progress and consequences of a biological invasion is a difficult endeavour packed with complex variables and uncertainties.

IUCN describes the impacts of alien invasive species as **“immense, insidious and usually irreversible”**.

American botanist Warren Wagner of Michigan University explains the difficulty of predicting the effects of invasive alien species before it's arrival and invasion **“Nothing is more difficult than to predict what will happen to an exotic”**

## Impacts: Ecological and Environmental

Alien Invasive Species can impact the environment at all levels of organization including gene, species, habitat and ecosystem.

### Gene Pool

Same as humans, it is important to recognize that each organism is genetically unique with respect to the habitat and nature of the ecosystem.

**“If introduced or spread into habitats with closely related species, alien invasive species could interbreed with native species resulting in changes to the genetic makeup of either species (Secretariat of the Convention on Biological Diversity, 2003).”**

### Possible negative consequences of alterations in gene pool:

Reduction in the survival of either species

Creation of a more successful invader

Creation of hybrids that could be more susceptible to certain pests and pathogens

Loss of gene pools

### Ecosystems

The impacts of alien invasive species at the ecosystem level include changes to trophic structures, changes in the availability of resources such as water and nutrients, and changes in the disturbance regimes (McNeely et al., 2001; Secretariat of the Convention on Biological Diversity, 2003a).

### Species

Invasive alien species can influence species diversity, richness, composition and abundance. At the species level, direct effects of alien invasive species occur through processes such as the predation of, competition with, and pathogen and parasite transmission to individual organisms, eventually leading to population declines and species extinctions (Loehle, 2003; Secretariat of the Convention on Biological Diversity).

### Habitats

Through their impacts on species and ecosystem processes, alien invasive species can result in the fragmentation, destruction, alteration or complete replacement of habitats which in turn, has cascading effects on even more species and ecosystem processes (McNeely et al., 2001; Secretariat of the Convention on Biological Diversity, 2003a).

### Ecosystems

Changes subjected to the ecosystem can include changes to trophic structures, changes in the availability of resources, etc.

### Economy

Economic impacts can be either direct or indirect. Direct costs are of those related to mechanisms adopted in controlling the spread of invasive species, while the degradation of ecosystem services can be accounted as the indirect.

### Social & Health

These species often triggers skin complications, while they act as vectors for dangerous pathogens and diseases. Loss of food sources and decrease of land value are often associated with the introduction of invasive species.



Asian Tiger Mosquito, (*Aedes albopictus*) native to South East known to carry over 20 highly dangerous human pathogens such as dengue, yellow fever and chikungunya was introduced to Europe in the form of eggs on used tyres or heavy duty equipment. Regular mosquito outbreaks have been reported across western and southern Europe, where it poses a major health risk.

**Since the 17<sup>th</sup> Century invasive alien species is accountable to nearly 40% of all animal extinctions for which the cause is known**

-UNEP-



Through direct impacts on species or through alterations of habitats, invasive alien species are responsible for placing 762 forest species at risk (IUCN, 2005). The loss of such species is leading to a more homogenous world which is perhaps the biggest threat to global biological diversity, behind habitat loss

(Perrings, Williamson and Dalmazzone, 2000; McNeely et al., 2001; Richardson and Rejmánek, 2004).



Miconia

*Miconia calvescens*

-Shades out native plants and completely takes over forests

-Shallow root systems encourage erosion  
-Decreases the amount of rainwater into the watershed

-The seeds spread easily through animals and even through dirt/mud stuck in vehicles, shoes, clothing, etc.

Has overtaken two-thirds of Tahiti's Forests, since its introduction in 1937 and is directly responsible for threatening 25% of their native forest species with extinction.

Invasive alien species are often associated with many emerging infectious diseases such as **Lyme disease, Ebola, Marburg hemorrhagic fevers, malaria, yellow fever, leishmaniasis, trypanosomiasis and Kyasanur forest disease**

(Morse, 1995; Sanchez et al., 1995; Wilson, 1995; Daszak, Cunningham and Hyatt, 2000; Chivian, 2001; Chivian, 2002; Cinco et al., 2004).

Giant Hogweed Plant  
*Heracleum mantegazzianum*



Wisknotweed

Has been introduced to countries as an ornament. The plant has the potential to readily disperse and can grow along roadsides, ditches and streams. It contains high toxins which can cause severe dermatitis and burns when exposed to sunlight. If in contact with the eyes it can cause blindness to the eyes. Each year in Germany alone, 6 to 21 million Euros are spent for eradication and medical treatment. With its dense impenetrable strands, it can also reduce the biological diversity of the native plant species.

80% of the threatened species in the Fynbos biome of South Africa are endangered due to invasions by alien species

North American Red Swamp Crayfish,  
*Procambarus clarkii*



Simon Davey

The North American red swamp crayfish, (*Procambarus clarkii*), was originally introduced into Europe for use in aquaculture. Having escaped into freshwater streams, this aggressive species has since spread across several EU countries, actively colonizing new territories at the expense of rarer native crayfish, such as *Austropotamobius pallipes* which is listed in the Habitats Directive. Apart from causing local extinctions, the red swamp crayfish is also a carrier of a fungus-like organism that is wiping out entire populations of European crayfish. The disease alone is estimated to have an economic cost of over €53 million/year.

Annual environmental losses caused by introduced pests in the US, UK, Australia, South Africa, India, Brazil have been calculated at over **US\$100 billion**

-CBD-

It is estimated that US spends around 80 Billion to combat biological invaders.

# Islands & Invasive Alien Species

As an island nation with dispersed and isolated geographical characters, Maldives limits immigration of new species, allowing established species to evolve with few strong competitors and predators. However, through human activity invasive alien species can be introduced causing dramatic changes to the island ecosystems. Island ecosystems are more prone to invasion by alien species with the lack of natural competitors and predators.

Being a small island developing state the issue threatens the fragile ecosystem, livelihood, economy and the wellbeing of its citizens.

## Common pathways for the arrival of IAS

Ship ballast water, hull fouling, cargo containers and packaging materials, unprocessed commodities such as timber/agricultural goods, imported food species such as fish, horticultural/plant imports, waste material, military activities, and biological agents to combat pests.

## Island Birds & IAS

Invasive alien species are stated among the most common threat to the avifauna of islands. Introduced rats, cats and diseases are accounted for half of the global bird extinctions over the past 500 years.

Invasive alien plants and trees have decreased water supplies for nearby communities and increased fire hazards in South Africa (McNeely et al., 2001; van Wilgen et al., 2001; Petit et al., 2004)

Australian Acacia species, such as *A. cyclops* and *A. saligna*, have radically altered nutrient cycling regimes in nutrient poor ecosystems due to their ability to fix atmospheric nitrogen (van Wilgen et al., 2001).

## Island birds & IAS

Invasive species are among the most common threat to global avifauna and islands in particular. Invasive alien species, mostly from introduced rats, cats and diseases are responsible for half of the global bird extinctions over the 500 years.

Bird Life International

## ScrewPine. *Pandanus*

Screwpine or locally referred to as Kashikeyo have been one of the core ingredients in many delicacies in Maldives. With the absence of common staple foods in the World War II, it is known that Maldivian communities relied on Screwpine to fill the void.



The native species of the screwpine are now threatened with the introduction of alien specimens. It is believed that these specimens were first introduced from a Caribbean country and distributed throughout the Maldives. Since the introduced screwpines had preferable features over the natives, farmers tend to promote the introduced foreign species of screwpine. At present the local vegetable and fruit market is occupied by these alien specimens, side-lining the natives.

# Countering the issue of Invasive Alien Species

Each invasive alien present deserves individual management plans with respect to the habitat and environmental conditions.

Counter actions can be categorized into prevention, mechanical, chemical, biological, indirect and integrated.

## Prevention

As a rule of thumb, prevention is the most cost-effective method against the issue of alien invasive species. Throughout the world, governments have imposed stringent laws and regulations to minimize the entry of invasive species. Common practices under prevention can be custom checks, shipment inspections and quarantine. Awareness of the general public is important for successful implementation of preventive measures.

## Mechanical

These methods include use of machines, hand picking, soil tillage, trapping, shooting, etc.

## Biological Methods

Biological control includes various methods which is associated around the use of a living organism as a predator with the aim of controlling a particular target alien invasive species.

### Control strategies of biological means include:

**Introduction** (classical biological control) of a herbivore or parasite from the 'pest's' area of origin;

**Inoculation** - repeated releases (of sterile males, for example) so as to prevent pest build-up;

**Inundation** - where large numbers of natural enemies are cultured and released during critical periods in the life cycle of the crop or other alien species;

**Conservation** - where measures are taken to conserve and enhance the numbers of natural enemies already present in an area thus decreasing the mortality of the affected species; and

**Augmentation** - where natural enemies of a pest are at too low a level and the numbers are augmented by artificial rearing and release.

## Chemical Methods

**Herbicides/Pesticides:** The most widely used method in eradicating unwanted animals and plants.

**Anti-Coagulant poisons:** Used to eradicate rodents by effectively blocking the vitamin K cycle, inhibiting the ability to produce essential blood-clotting factors.

**Immunization:** Animals are given immunization doses to combat from potential invasive species. In Ontario, raccoons and skunks are immunized to prevent the rabies virus.

**Impeding reproductive ability:** The method utilizes hormones to lower the reproductive potential of the species.

**Pheromones:** uses traps based on chemicals produced by the target species to attract members of the same species.

Pimentel, Zuniga and Morrison (2005) estimates that the 50 000 alien species in the United States cost almost US\$120 billion in environmental damages and losses yearly. Pimentel et al. (2000) gave an estimate of US\$137 billion per year.

Pimentel et al. (2001) looked at over 120 000 alien species of plants, animal and microbes that have invaded Australia, Brazil, India, South Africa, the United Kingdom and the United States causing significant economic losses in the agriculture and forest sectors and negatively affecting ecosystems. They estimated that the total cost in the six countries was US\$314 billion in damages per year - Australia (\$13 billion), Brazil (\$50 billion), India (\$116 billion), South Africa (\$7 billion), the United Kingdom (\$12 billion) and the United States (\$116 billion).

OTA (1993) concluded that about 4 500 exotic species occur in the United States and that about 20 percent of them have caused serious economic and environmental harm. The cumulative loss caused by 79 of these species was estimated at almost US\$97 billion for the period 1906 to 1991.

# Pemphis Talk

Pemphis meets Senior Superintendent of Maldives Customs Service.

Hussain Hameed



## Procedure followed by Customs when dealing with imported species

Since Customs is an enforcement agency, we follow laws and regulations set by policy making institutes. As per norm, Customs will ensure the species to be imported have been granted permissions from the relevant institutes.

If the species is found to be illegal, Customs will confiscate the species and handover to the relevant authorities; in required cases, extermination of the species will be carried out in presence of the relevant authorities.

## Experience sharing of Customs with other countries:

Illegal doings along the border are shared with Regional Intelligence Liaison Office, World Customs Organization and countries of interests as well.

## Most Common Cases:

Snakes and Birds

## Trend in the imports of Alien Species:

A study is required to derive the actual statistics but with regard to the cases we can assume that the **trend is definitely not decreasing.**

## Highest priority of Customs:

**Narcotics comes first,** followed by others

## Advice to the general public on this matter:

The importers should know legal status of the subject to be imported. People should find out information about legal and illegal species before trying to import it. **Individuals should bare their responsibility towards the wellbeing of the nation before their own personal amusements.** Don't get involved in any illegal activity even if it's related to a friend of a family member. The general public is not aware. **People should share the information with customs or police about alien species; (if it's being smuggled into the country or if anyone is in possession of such a species).** There is a mechanism in which information could be shared without disclosing who you are.

## Health and Safety concerns of Customs officers when dealing with these species

Since Customs is an authority working at the frontlines the threat of such an event is there. As per health and safety Customs may always not be prepared in terms of work health and safety since such events would be isolated and dispersed.

## Mechanism in identifying alien species:

At present there is no such mechanism formulated, but we are in need of one. Customs do have some difficulties therefore we need more training to be informed of the species.

## Emergency plan, such as a virus infected shipment:

At the moment we lack a plan; but we are formulating such a plan which covers the required procedures.

## Customs perspective on the relation between illegal imports of species and narcotics:

These species have been confiscated from Police operations regarding narcotics, so therefore it is known that there is a link between these two. With respect to the available information, drug dealers have these exotics as their pets.

## Challenges faced by Customs in dealing with Alien Species:

Customs are required to check a lot of areas; it is fairly easy to check the airport passenger terminal area while Customs face difficulties in the air-cargo area. With the dispersion of sea vessels and the marine routes poses the greatest challenge for customs.

Another challenge is that the lack of coordination between the institutes working at the border. **To have a dedicated law and regulation to tackle the issue would be one of the solutions while implementing a documented rigid coordinating system to manage the ports among the relevant authorities and stakeholders.**

Public awareness and awareness campaigns regarding the issue is inadequate. **It is important to step up these campaigns as it is not just Customs officers who should be aware of this.**

## Reason for the demand in smuggling Alien Species:

As per Customs perspective the demand is dependent upon **two factors; import duty and legality of the subject.** If the import duty is high or if the subject is banned or illegal; smuggling and demand does increase along with the associated profit of the sale.

**Meet this month's  
Writers & Contributors**

Mohamed Zahir  
Miruza Mohamed  
Ilham Atho Mohamed  
Fazeela Ahmed Shaheem  
Mohamed Simah  
Aishath Aileen Niyaz  
Hassan Nidham  
Midhath Abdul Rasheed  
Aishath Huma  
Aminath Maiha Hameed  
Mauman Abdul Rasheed  
Ahmed Anwar  
Mohamed Furaz  
Ismail Ajmal  
Mohamed Aflah

**Layout & Design by:**

Mohamed Aflah  
Ismail Ajmal

**Published by:**

Environment Department,  
Ministry of Environment and Energy,  
Green Building, Handhuvaree Hingun Maafannu,  
Male', Republic of Maldives.

You too can contribute to Pemphis newsletter.  
Send pictures and articles to [environment@environment.gov.mv](mailto:environment@environment.gov.mv)  
We welcome all comments on the articles.

 @EnvGovMv

 [facebook.com/environment.gov.mv](https://facebook.com/environment.gov.mv)

